

Chapter H 62

**RULES AND REGULATIONS GOVERNING THE
DESIGN, CONSTRUCTION, INSTALLATION,
SUPERVISION AND INSPECTION
OF PLUMBING**

H 62.01	Basic plumbing principles	H 62.13	Rain water connections
H 62.015	Approval on experimental basis	H 62.14	Special requirements
H 62.02	Plumbing definitions	H 62.15	Materials
H 62.03	Fixture unit design basis	H 62.16	Joints and connections
H 62.04	Building sewers	H 62.17	Repairs and reconstruction
H 62.05	Building drains	H 62.18	Water supply systems
H 62.06	Stacks and branches	H 62.19	Back siphonage and cross connections
H 62.07	Vents	H 62.20	Private domestic sewage treatment and disposal systems
H 62.08	Fixture drain connections	H 62.21	Inspection and tests
H 62.09	Fixtures		
H 62.10	Traps and cleanouts		
H 62.11	Catch basin, sumps, ejectors		

H 62.01 Basic plumbing principles. (1) The basic principles of this code are enunciated as basic goals in environmental sanitation and safety worthy of accomplishment through properly designed, acceptably installed, and adequately maintained plumbing systems. Some of the details of plumbing construction must vary, but the basic sanitary and safety principles are the same. The results necessary to obtain the desired protection for the health of the people are the same everywhere. As unforeseen situations arise which are not specifically covered in the body of this code, the following principles shall serve to define the intent.

(2) Plumbing in all buildings, public and private, intended for human occupation or occupancy, shall at all times be installed in such manner so as to protect the health, safety and welfare of the public or occupants.

(3) Every building intended for human habitation or occupancy shall be provided with a supply of potable water; such supply shall not be cross connected with an unsafe water supply or with a waste pipe nor be subjected to any hazards of backflow or back-siphonage. When the premises abut on a street in which there is a public water-main, there shall be an individual connection to the public system.

(4) Buildings in which water closets and other plumbing fixtures, devices and appurtenances exist or are to be installed shall be provided with a supply of water adequate in volume and pressure by means of proper pipe sizing to insure that efficient use of the fixture is possible at all times.

(5) Devices for heating water and storing it in pressure vessels or tanks shall be so designed and installed as to prevent dangers of explosion or overheating.

(6) Every building intended for human habitation or occupancy on premises abutting on a street in which there is a public sewer shall have an individual connection with the public sewer.

(7) In multiple dwellings provided with a drainage system, there shall be at least one private water closet and one wash basin for each family. Installation of a kitchen sink and bathtub or shower is recommended.

(8) The entire building drainage system shall be so designed, constructed, and maintained as to conduct the waste water or sewage quickly from the fixture to the place of disposal, with velocities which will prevent clogging, fouling and the depositing of solids and shall have adequate cleanouts so arranged that the pipes may be readily cleaned.

(9) The drainage pipes should be so designed and constructed as to be proof for a reasonable life of the building against leakage of water or sewer drain air and offensive odors due to defective materials, imperfect connections, corrosion, settlements or vibrations of the ground or building, temperature changes, freezing or other causes.

(10) The drainage system shall be so designed that there will be an adequate circulation of air in all pipes, no danger of siphonage, aspiration or forcing of trap seals under conditions of ordinary use.

(11) All rooms in which water closets, urinals or similar fixtures are installed shall have adequate lighting and have proper ventilation to the outer air.

(12) Hot water shall be supplied to all plumbing fixtures which normally need or require hot water for their proper use and function.

(13) Plumbing fixtures shall be made of durable, smooth, non-absorbent and corrosion resistant material and shall be free from concealed fouling surfaces.

(14) If water closets or other plumbing fixtures exist in buildings where there is no sewer within a reasonable distance, suitable provision shall be made for disposing of the building sewage by some method of sewage treatment or disposal satisfactory to the department and local health authority having jurisdiction.

(15) Plumbing systems shall be maintained in a sanitary condition.

(16) Proper protection shall be provided to prevent contamination of food, water, sterile goods and similar materials by backflow of sewage.

(17) Plumbing shall be designed and adjusted to use the minimum quantity of water consistent with proper performance and cleaning.

(18) Fixtures, devices, appliances and appurtenances shall be supplied with water sufficient in volume and at pressures adequate to enable them to function satisfactorily and without undue noise under all normal conditions of use.

(19) All plumbing fixtures shall be so installed as to provide adequate spacing and shall be reasonably accessible for their intended use and for cleansing.

(20) Sewage or other wastes shall not discharge into water surface or sub-surface soil unless it has first been subjected to some acceptable form of treatment.

History: 1-2-56; r. and recr. Register, October, 1970, No. 178, eff. 11-1-70.

H 62.015 Approval on experimental basis. Materials, fixtures, appurtenances, devices, appliances, system designs and layouts other
Register, October, 1971, No. 190

than those set forth in this code may be approved by the division administrator for specific installations or for experimental use or for trial purposes.

History: Cr. Register, October, 1970, No. 178, eff. 11-1-70.

H 62.02 Plumbing definitions. General. For the purpose of this code, the following terms shall have the meaning indicated in this section. No attempt is made to define ordinary words which are used in accordance with their established dictionary meaning except where it is necessary to define their meaning as used in this code to avoid misunderstanding.

Note: For definitions of master plumber, journeyman, restricted plumbers, apprentices and registered learners refer to Chapter 145 of the Wisconsin Statutes.

(1) **PLUMBING** in this code shall be defined as set forth in Wis. Stats. 145.01 (a) (b) (c) (d) and (e).

(2) **AIR-BREAK (DRAINAGE SYSTEM)**. A piping arrangement in which a drain from a fixture, appliance, appurtenance or device discharges indirectly into another fixture, receptacle, or interceptor at a point below the flood level rim.

(3) **AIR-GAP (DRAINAGE SYSTEM)**. The unobstructed vertical distance through free atmosphere between the terminus of the waste pipe and the flood level rim of the fixture, sight waste or other receptacle into which it discharges.

(4) **AIR-GAP (WATER SUPPLY SYSTEM)**. The unobstructed vertical distance through the free atmosphere between the lowest opening from any pipe or faucet supplying water to a tank, vat, plumbing fixture or other device and the flood level rim of the receptacle.

(5) **ALIGNMENT**. Installed in a straight line, either horizontal, vertical or at a given angle.

(6) **APPLIANCES AND APPURTENANCES**. Includes any item or type of equipment not otherwise specifically defined, which is connected directly or indirectly with any portion of the plumbing system.

(7) **APPROVED**. Approved or accepted by the State Department of Health and Social Services, Division of Health.

(8) **AREA DRAIN**. A receptacle designed to collect surface or storm waters from an open area.

(9) **ASPIRATOR**. A fitting or device supplied with water or other fluid under positive pressure which passes through an integral orifice or "constriction" causing a vacuum.

(10) **AUTOPSY TABLE**. A fixture or table used for post-mortem examination.

(11) **BACKFLOW**. The reversal of flow of liquids in a piping system.

(12) **BACKFLOW PREVENTER (REDUCED PRESSURE ZONE TYPE)**. An assembly of differential valves and check valves including an automatically opened spillage port to the atmosphere.

(13) **BACK-SIPHONAGE**. The formation of a negative pressure or vacuum which may occur in a water supply pipe causing the backflow of contaminated or polluted liquids to intermix with the potable water.

(14) **BACKWATER VALVE.** A device designed to prevent the reverse flow of storm water or sewage into the drainage system or branches thereof.

(15) **BASEMENT.** The lowest floor line elevation below grade which can be drained to the building sewer by gravity. All other stories below such elevation shall be considered sub-basement levels.

(16) **BATTERY OF FIXTURES.** Any group of 2 or more similar use adjacent fixtures installed so as to discharge into the same common horizontal soil or waste pipe.

(17) **BEDPAN STEAMER.** A fixture used for scalding bedpans or urinals by direct application of steam.

(18) **BEDPAN WASHER.** A fixture designed to wash bedpans and to flush the contents into the soil drainage system. It may also provide for sterilizing.

(19) **BEDPAN WASHER (HOSE).** A device supplied with hot and cold water and located adjacent to a receptacle for cleansing bedpans.

(20) **BELL (OR HUB).** That portion of a pipe which for a short distance is sufficiently enlarged to receive the end of another pipe of the same diameter for the purpose of making a joint.

(21) **BOILER BLOW-OFF BASIN.** A vessel designed to receive the discharge from a boiler blow-off outlet and to cool the discharge to a temperature which permits its safe entry into the drainage system.

(22) **BRANCH.** Any part of a piping system other than a main or stack.

(23) **BUILDING.** A structure having walls and a roof erected or set upon an individual foundation or slab-constructed base designed or used for the housing, shelter, enclosure or support of persons, animals or property of any kind. For purposes of this code, each structure abutting another structure which does not have an approved ingress-egress doorway through the basement foundation walls, or structures with separate exterior or exterior abutting walls, or public use structures separated by an unpierced firewall, shall be considered as a separate or individual building.

(24) **BUILDING (PRIVATE RESIDENCE).** A one family building or dwelling. See dwelling unit.

(25) **BUILDING (PUBLIC).** Means and includes any structure, including exterior parts of such building, such as a porch, exterior platform or steps providing means of ingress or egress, used in whole or in part as a place or resort, assemblage, lodging, trade, traffic, occupancy or use by the public, or by 3 or more tenants.

(26) **BUILDING DRAIN.** See sewers and drains.

(27) **BURR.** Roughness or metal protruding from the walls of a pipe usually as the result of cutting the pipe.

(28) **BY-PASS.** An installation of control valves and piping so installed as to temporarily isolate or by-pass a specific fixture, appliance, equipment or area of piping.

(29) **CATCH BASIN.** See interceptor.

(30) **CESSPOOL.** A covered excavation in the ground which receives sewage or other organic wastes from a drainage system, and so designed as to retain the organic matter and solids, permitting the liquids to seep into the soil cavities. **PROHIBITED IN WISCONSIN.**

(31) **CISTERN.** A covered tank in which rainwater from roof drains is stored for household use or other purposes.

(32) **CLEANOUT.** A metallic plug or cover joined by means of a screw thread to an opening in a pipe, which can be removed for the purpose of cleaning or examining the interior of the pipe.

(33) **CLEAR WATER WASTES.** Cooling water and condensate drainage from refrigeration compressors and air-conditioning equipment, waste water drainage used for equipment chilling purposes, liquids having no impurities or where impurities have been reduced below a minimum concentration considered harmful and cooled condensate from steam heating systems or other equipment.

(34) **CODE.** These regulations, subsequent amendments thereto, or any emergency rule or regulation adopted governing the installation of plumbing, drainage and water supply or distribution system on private property.

(35) **COMBINATION FIXTURE.** A fixture combining one sink and laundry tray or a 2 or 3 compartment laundry tray in one unit.

(36) **CONDUCTORS.** The system of roof leaders, downspouts and pertinent piping located inside or outside of building, conveying storm or rainwater from the roofs of buildings or area to the storm drain, storm sewer, catch basin, rainwater cistern or ground surface.

(37) **CONTINUOUS WASTE.** A drain from two compartments of a single fixture connected to a single trap.

(38) **CROSS-CONNECTION.** Any physical connection or arrangement between two otherwise separate piping systems, one of which contains potable water and the other either water of unknown or questionable safety, or steam, gas or chemical, whereby there may be a flow from one system to the other, the direction of flow depending on the pressure differential between the two systems. See backflow and back-siphonage.

(39) **DEAD END.** That part of a drainage system which terminates upstream from the base of a vertical soil or waste stack or which is without a free circulation of air.

(40) **DEPARTMENT.** Department of Health and Social Services.

(41) **DEVELOPED LENGTH.** The length of a pipe line measured along the center line of the pipe and fittings.

(42) **DIP TUBE.** A pipe which conveys the cold water supply to the lower portion of an automatic water heater or water storage tank when the inlet opening is in the top portion of the tank.

(43) **DOMESTIC WASTES.** The water-carried wastes derived from ordinary living processes. See sewage.

(44) **DRAINAGE SYSTEM.** A drainage system includes the piping within public or private premises, which conveys sewage, rainwater or other liquid wastes to a legal point of disposal, but does not include

the mains of a public sewerage system or private or public sewage treatment plant.

(45) **DURHAM SYSTEM.** A term used to describe soil or waste systems where all piping is threaded pipe, tubing or other such rigid construction, using recessed drainage fittings, to correspond to the types of piping.

(46) **DWELLING UNIT.** One or more rooms with provisions for living, sanitary and sleeping facilities arranged for the use of one or more individuals of the same family

(47) **EJECTOR.** A device operated either electrically or by a mechanical means so constructed as to elevate liquid wastes and sewage from a lower level to a point of discharge into a public or private sewer or other final means of disposal.

(48) **FERRULE.** A metallic sleeve used to connect dissimilar plumbing materials.

(49) **FIRE PROTECTION SYSTEM.** A system of pipes and appurtenances used exclusively to supply water for extinguishing fires except the water service pipe as stipulated in Sec. 145.01 (1) (c), Wis. Stats.

(50) **FIXTURE.** A receptable, appliance, device or equipment with or without a connection to the water supply system intended to receive or discharge water, liquids or water-carried wastes directly or indirectly into a drainage system.

(51) **FIXTURE UNIT.** A design factor so chosen that the load producing values can be expressed as multiples of that factor.

(52) **FIXTURE UNIT (DRAINAGE d.f.u.).** A measure of the probable discharge into the drainage system by various types of plumbing fixtures. The drainage fixture unit value for a particular fixture depends on its volume rate of discharge, on the duration of a single drainage operation and on the average time between successive operations.

(53) **FIXTURE UNIT (WATER SUPPLY s.f.u.).** A measure of the probable hydraulic demand on the water supply by various types of plumbing fixtures. The supply-unit value for a particular fixture depends on its volume rate of supply, the time duration of a single supply operation and the average time between successive operations.

(54) **FIXTURE UNIT FLOW RATE.** The total discharge flow in gallons per minute of a single fixture divided by 7.5 provides the flow rate of a particular fixture as a unit of flow. Fixtures are rated as multiples of this unit of flow.

(55) **FLOOD-LEVEL RIM.** The flood-level rim is the top edge of the receptacle from which water overflows.

(56) **GARAGE (PUBLIC).** A building or part of a building which accommodates or houses self-propelled land, air or water vehicles for 3 or more persons not of the same family.

(57) **GARAGE (PRIVATE).** A building used for the storage of vehicles or other purposes by a private family and which is not available for public use.

(58) **GRADIENT.** The fall or slope of a line of pipe in reference to a horizontal plane. In drainage systems it is usually expressed as the fall in a fraction of an inch per foot length of pipe.

(59) **HORIZONTAL PIPE.** Any pipe or fitting which makes an angle of less than 45 degrees to the horizontal.

(60) **HOT WATER.** Water at a temperature of 120° F. or more.

(61) **INDIRECT WASTE PIPE.** A waste pipe which does not connect directly to the drainage system, but conveys liquid wastes by discharging into the drainage system through an air-break, air-gap, into a trap, fixture, receptacle or interceptor.

(62) **INDUSTRIAL WASTES.** The liquid wastes resulting from the processes employed in industrial establishments which are free from fecal matter.

(63) **INTERCEPTOR.** A device designed and installed so as to retain deleterious, hazardous or undesirable matter from normal wastes while permitting normal sewage or liquid wastes to discharge into the drainage system by gravity.

(64) **GREASE BASIN (EXTERIOR).** A watertight tank installed underground for the collection and retention of grease from cooking or food processing and which is accessible for periodic removal of the contents.

(65) **GREASE INTERCEPTOR.** A manufactured receptacle designed to intercept and retain grease or fatty substances contained in kitchen and other food wastes.

(66) **GRIT & SAND INTERCEPTOR.** A receptacle designed to intercept and retain sand, grit, earth and other similar solids.

(67) **OIL INTERCEPTOR.** A unit designed to intercept and retain oil, lubricating grease or other like materials.

(68) **MANHOLE.** An opening constructed to a sewer or any portion of a plumbing system of sufficient size to permit a man to gain access thereto.

(69) **MAY.** May implies neither compulsion nor recommendation, only permission.

(70) **MOBILE HOME.** A structure mounted on a wheeled chassis designed for highway transport. When placed upon, fastened or affixed to a foundation, pillars or like support, or when exceeding 45 feet in length, the structure shall be considered as a building or housing unit. See sec. 348.07 (2) Wis. Stats.

(71) **NON-POTABLE WATER.** Water not safe for human consumption, hygiene or culinary use.

(72) **NUISANCE.** A "nuisance" under this section is referred to as any source of filth or probable cause of sickness pursuant to the provisions of sec. 146.14 of the Wis. Stats.

(73) **PIPE DIAMETERS.** When used in this code, shall mean the inside cross sectional dimension.

(74) **PLACE OF EMPLOYMENT.** Every place, whether indoors or out, or underground, and the premises appurtenant thereto, where either temporary or permanently any industry, trade or business is carried on, or where any process or operation, directly or indirectly related to any industry, trade or business is carried on and where any person is directly or indirectly employed by another for gain or profit, but shall not include any place where persons are employed in private or

domestic service or agricultural pursuits which do not involve the use of mechanical power.

(75) **PLUMBING SYSTEM.** The plumbing system includes all water supply, water services and water distribution piping, plumbing fixtures and traps; soil, waste, and vent pipes; building drains, building sewers and private domestic sewage disposal systems including their respective connections, equipment, devices, appliances and appurtenances within the property line of the premises; and water-treating or water-using equipment in connection with the water and drainage systems and the installation thereof.

(76) **POTABLE WATER.** Potable water is water which is satisfactory for human consumption, hygiene and culinary use and meets the requirements of the state administrative authority having jurisdiction.

(77) **PRIVY.** A structure used by the public for the deposition of human body wastes.

(78) **PRIVY VAULT.** A watertight pit receptacle beneath a privy which receives human body wastes.

(79) **RADIUS.** Radius is the distance from a center line or point to an axis of rotation.

(80) **RECEPTOR.** A fixture or device which receives the discharge from indirect wastes pipes.

(81) **REPAIRS & STOPPAGES.** Consists of making minor repairs to faucets, valves, pipes, appliances and removing of stoppages in building drains and sewers or waste pipes.

(82) **ROUGHING-IN.** The installation of all soil, waste, vent, water supply piping and supports pertinent thereto within a building to which fixtures, appliances and equipment are to be connected.

(83) **SAPING.** A pan or other collector placed beneath a pipe or fixture to prevent leakage from escaping to the floor, ceiling or walls.

(84) **SANITARY SEWER.** A sanitary sewer is a pipe which carries sewage and excludes storm, surface and ground waters.

(85) **SEWAGE.** The water carried wastes (organic) created in and to be conducted away from residences, industrial establishments and public buildings. See domestic wastes.

(86) **SEWERAGE SYSTEM (PUBLIC).** All structures, conduits and pipe lines by which sewage is collected and disposed of, except plumbing inside and in connection with buildings and properties served, and service pipes from building to street main. See Ch. 144, Wis. Stats.

(87) **SEWAGE SYSTEM (PRIVATE).** (a) A system comprised of a septic tank and effluent absorption area designed for the purpose of processing sewage wherever public sewer facilities are not available.

1. **Annular space.** The area between the seepage pit chamber wall exterior and the unexcavated earth wall.

2. **Bedrock.** Any solid exposed rock or overlain by unconsolidated material.

3. **Detailed soil map.** A map prepared by a state or federal agency showing soil series, type and phases at a scale of not more than 2,000 feet to the inch.

4. Distribution pipe. A conduit of perforated clay tile, bituminous fiber, cement asbestos or short lengths of clay or concrete drain tile.

5. Effluent. Liquid flowing from a septic or treatment tank.

6. Flood plain. That portion of the land flooded by the highest known flood water elevation or that portion of the land that would be flooded by the regional flood elevation established by a state or federal agency.

7. High ground water. The upper limit of the portion of soil or underlying material that is saturated with water. (In some instances an upper or perched water table may be separated from a lower one by an impervious zone.)

8. High water level. The highest known flood water elevation of any lake, stream, pond or flowage or the regional flood elevation established by a state or federal agency.

9. Holding tank. An approved watertight receptacle for the retention of sewage.

10. Legal description. An accurate Metes and Bounds description or a lot and block number in a recorded subdivision or recorded assessor's plat or a public land survey description to the nearest 40 acres.

11. Percolation test. A method of testing absorption qualities of the soils.

12. Reservoir. A watertight receptacle basin or vault constructed above ground surface or underground for the storage of water intended for domestic use.

13. Seepage pit. An underground receptacle so constructed as to permit disposal of effluent or clear wastes by soil absorption through its walls.

14. Seepage bed. An excavated area similar to a seepage trench but larger than 3 feet in width and containing more than one distribution line.

15. Seepage trench. An area excavated 3 feet or less in width which contains a bedding of aggregate and a single distribution line.

16. Septic tank. A watertight tank which receives sewage.

17. Soil boring. A method of augering, boring or excavating through the ground surface to obtain samples of various stratum of earth to determine the characteristics and absorptive qualities of the soil, bed-rock and ground water elevations.

18. Vent cap. An appurtenance of approved type used for covering the vent terminal of an effluent disposal system so as to avoid closure by mischief or debris and still permit circulation of air within the system.

(88) SEWERS & DRAINS. (a) *Sanitary*. 1. Building sewer. That part of the plumbing system beginning at the immediate outside foundation or proposed foundation wall to its connection with the main of a public sewer, private sewer, private sewage disposal system or other point of disposal.

2. Building drain. The lowest horizontal piping of a drainage system which receives the discharge of soil, waste and other drainage pipes inside any building and conveys same to the building sewer by gravity flow. The minimum building drain extends from the building sewer to all soil stacks.

3. Building drain. (Waste pipe). That part of any drainage system which extends laterally at a slight grade, with or without horizontal

change of direction from the building drain or subdrain. In this definition, horizontally means an angle less than 45 degrees with a horizontal plane and a rise not to exceed the inside diameter of the branch.

4. Building subdrain. The horizontal portion of a drainage system within a building which cannot flow by gravity to the building drain.

(b) *Storm*. 1. Building sewer. That part of the storm water system which receives the discharge from building storm drains and subdrains, parking lots, yard fountains and other permissive sources, and conveys such waters to a public storm water system, private storm water system or other approved point of disposal.

2. Building drain. The lowest horizontal piping which receives storm waters or other permissive water from roofs, area ways, court yards, canopies, enclosed parking ramps and other sources inside any building or structure and conveys same to the building storm sewer by gravity flow.

3. Building subdrain. Same as sanitary subdrain.

(89) SEWER (PRIVATE). A privately owned sewer.

(90) SEWER (PUBLIC). A publicly owned sewer.

(91) SUBSOIL DRAIN. That part of a drainage system which conveys the ground or seepage water from the footings of walls or below the basement floor under buildings to the storm sewer or other point of disposal.

(92) SHALL. The word "shall" when used in this code is a mandatory requirement.

(93) SHOULD. "Should" is not mandatory but expresses the recommendation of the department.

(94) SIPHONAGE. A suction created by the flow of liquids in pipes.

(95) SLIP-JOINT. A connection in which one pipe slips into another, the joint of which is made tight with a compression type fitting.

(96) SPECIAL WASTES. Wastes which require special treatment before entry into the normal plumbing system.

(97) SPECIAL WASTE PIPE. Piping which conveys special wastes.

(98) SPIGOT. The end of a pipe which fits into a bell or hub.

(99) STACKS & BRANCHES. (a) *Stacks*. 1. Soil stack. Any pipe extending vertically which conveys the discharge of water closets, bedpan washers or like fixtures with or without other fixtures to a horizontal branch, building drain or building subdrain.

2. Waste stack. Any pipe extending vertically which receives only liquid wastes free from fecal matter and conveys same to a horizontal branch, the building drain or building subdrain.

(b) *Branches*. 1. Branch. A horizontal drain pipe extending from a soil or waste stack to which vertical sections or extensions may be connected which receive the discharge from one or more fixture drains.

2. Branch interval. A distance along a soil or waste stack corresponding in general to a story height but in no case less than 8 feet within which the horizontal branches from one story of a building are connected to the stack.

(100) **STERILIZERS.** (a) *Boiling type.* A non-pressure type device used for boiling instruments, utensils, and/or other equipment for disinfection purposes.

(b) *Pressure instrument washer-sterilizer.* A pressure vessel fixture designed to both wash and sterilize instruments during the operating cycle of the unit.

(c) *Pressure (autoclave).* A pressure vessel designed to use steam under pressure for sterilizing. Also called an autoclave.

(d) *Water.* A device used for sterilizing water and storing sterile water.

(101) **STILL.** A device used in distilling liquids.

(102) **SUMP.** A tank or pit which receives sewage or liquid wastes located below the normal grade of the gravity system and which must be emptied by mechanical means.

(103) **SUMP PUMP.** A mechanical device other than an ejector for removing liquid waste from a sump.

(104) **SUPPORTS.** Supports, hangers, anchors and other devices for supporting and securing pipes, or fixtures to walls, ceilings, floors or structural members of a building.

(105) **SWIMMING POOL.** Any structure, basin chamber or tank containing an artificial body of water for swimming, diving or recreational bathing having a depth of 2 feet or more at any point.

(106) **TERMINAL.** That part of a drainage or vent piping system which projects above the roof of the building or at the end of the building effluent disposal system.

(107) **TRAP.** A fitting or device so designed and constructed as to provide, when properly vented, a liquid seal which will prevent the back passage of sewer air without materially affecting the flow of sewage or waste through it.

(a) *Trap crown.* Where the trap connects to or becomes a part of the horizontal arm of the trap which is integral with the trap.

(b) *Trap seal.* Trap seal is indicated by the height of the water column measured between the overflow and the dip separating the inlet and outlet arms of the trap.

(108) **TURF SPRINKLER UNIT.** A system of piping, appurtenances and devices so installed as to distribute water for lawn or other similar irrigation purposes without plumbing fixtures or means of use for human consumption.

(109) **VACUUM BREAKER.** An atmospheric device, pipe installed and designed to protect a water supply against back-siphonage by entry of air to relieve vacuums in the water distribution system. (A vacuum breaker is not designed to protect the water supply under conditions of backflow or back-pressures.)

(110) **VENT PIPE.** Any pipe provided to ventilate a plumbing system.

(a) *Back vent.* A pipe that connects to a soil or waste pipe to vent a single fixture trap and connects to the vent system above the fixture served with no part of it below the fixture trap.

(b) *Branch vent.* That part of the vent piping which extends horizontally with or without lateral or vertical extensions and to which other vent pipes connect.

(c) *Circuit vent.* A vent pipe which serves 2 or more fixture traps which discharge to a nearly horizontal soil or waste branch and extends from the downstream side of the furthestmost upstream fixture trap to the main soil or waste vent or main vent so that a circuit is formed.

(d) *Continuous vent.* A vertical vent pipe that is a continuation of the vertical waste pipe to which it connects.

(e) *Loop vent.* Similar to a back vent except that part of it extends below the trap it serves before reconnecting to the vent piping system.

(f) *Main soil or waste vent.* That part of the stack above the highest installed fixture opening or branch connection. (Commonly referred to as a stack vent.)

(g) *Main vent.* A vent pipe connected to the base of a soil or waste stack below the lowest fixture branch extending vertically with or without change of direction and which serves as a terminal for other vent pipe connections and terminates through the roof or connects with the main soil or waste pipe at a point 2 feet or more above the highest soil or waste opening, but in no case less than 38 inches above the highest floor on which soil or waste openings are installed.

(h) *Relief vent.* The vent pipe connected to a soil or waste pipe close to the stack in a manner to equalize minus and plus pressures in the stack.

(i) *Stack venting.* A method of venting a fixture or group of fixtures through the soil or waste stack.

(j) *Sterilizer vent.* A separate pipe or stack connected indirectly to the building drainage system at the lowest terminal, which receives the vapors from non-pressure sterilizers or the exhaust vapors from pressure sterilizers and conducts the vapors directly to the outer air. (Commonly referred to as vapor, steam, atmospheric or exhaust vent.)

(k) *Unit vent.* One which denotes an installation so arranged that one pipe will serve traps from two identical fixtures at the same point when connected to a vertical soil or waste pipe.

(l) *Wet vent.* That portion of a vent pipe which receives the discharge from wastes other than water closets, kitchen fixtures or other sources containing like sewage or fecal matter.

(m) *Yoke vent.* A pipe connecting upward from a soil or waste stack into a main vent pipe in a manner to equalize pressures within the stacks.

(111) **WATER SOFTENER.** An appliance, appurtenance or device used for the purpose of ion exchange or demineralizing water.

(112) **WATER SUPPLY (PRIVATE).** Private water supply means one or more sources of ground water, including facilities for conveyance thereof, such as wells, springs and pumps, on one property, other than those serving a municipality or a group of 10 or more premises of mixed ownership.

(113) **WATER SERVICE.** A pipe extended from the water main or private pumping system or other supply source with or without lateral extensions to the building, structure or other system to be served.

(114) **WATER DISTRIBUTION SYSTEM.** Those pipes which convey water from the service pipe to the plumbing fixtures, appliances, appurtenances, equipment, devices or other systems which are to be served.

(115) **WIPED JOINT.** The fusion of metal with solder, smoothly finished with a wiping cloth and having a thickness of at least one-fourth inch at the point where the pipes are joined.

(116) **WORKMANSHIP.** Work of such character that will fully secure the results sought in all the sections of this code as intended for the safety, welfare and health protection of all individuals.

(117) **YARD DRAIN.** The horizontal piping and its branches which convey the surface drainage from areas, courts or yards outside the walls of a building to the storm water sewer.

(118) **MISCELLANEOUS. Standards or Specifications Abbreviations.**

A.G.A. -----	American Gas Association, Inc. 420 Lexington Ave., New York, New York 10017
A.N.S.I. -----	American National Standards Institute, Inc. 1430 Broadway, New York, New York 10018
A.S.M.E. -----	American Society of Mechanical Engineers 29 W. 39th St., New York, New York 10018
A.S.S.E. -----	American Society of Sanitary Engineering 228 Standard Building, Cleveland, Ohio 44113
A.S.T.M. -----	American Society for Testing and Material 1916 Race St., Philadelphia, Pa. 19103
A.W.W.A. ----	American Water Works Association 2 Park Avenue, New York, New York 10016
C.S. -----	Commercial Standards, Supt. of Documents Government Printing Office, Washington, D. C. 20401
F.S. -----	Federal Specifications General Services Administration, Regional Office 3, Washington, D. C. 20407
M.S.S. -----	Manufacturers Standardization Society of the Valve and Fittings Industry 420 Lexington Ave., New York, New York 10017
N.S.F. -----	National Sanitation Foundation Testing Laboratory, Inc., P. O. Box 1468, Ann Arbor, Michigan 48106
U.L. -----	Underwriters' Laboratories, Inc. 207 E. Ohio Street, Chicago, Illinois 60611
W.C.F. -----	Water Conditioning Foundation 1201 Waukegan Road, Glenview, Illinois 60025

(119) **PROCESS PIPING.** Process piping is piping separated from the water distribution and/or drainage system by approved methods or means and used exclusively for refining, manufacturing, industrial or shipping purposes of every character and description.

History: 1-2-56; am. (8), (42) (b) and (c); (46) and (49), Register, February, 1957, No. 14, eff. 3-1-57; r. and recr. Register, October, 1970, No. 178, eff. 11-1-70; cr. (119), Register, October, 1971, No. 190, eff. 11-1-71.

H 62.03 Fixture unit design basis. (1) INTERMITTENT FLOW FIXTURES.

Table 1

Type of Fixture	Unit Value	Trap Minimum Size Inches	Soil or Waste Minimum Size Inches	Vent Minimum Size Inches
Automatic clothes washers, Commercial (individual)-----	4	2	2	1½
Commercial (large capacity)*-----	3	1½	1½	1½
Residential-----	3	1½	1½	1½
Bathtubs, all types**-----	6	2	3	2
Bed pan washer-----	2	1¼	1½	1½
Bidet-----	1	1¼	1¼	1¼
Cuspidor, fountain or dental-----	1	1¼	1¼	1¼
†Dishwasher (commercial)***-----	4	1½	1½	1½
†Dishwasher (residential)-----	1	1¼	1¼	1¼
Drinking fountain-----	½	1¼	1¼	1¼
Drinking fountain (refrigerated)-----	½	1¼	1¼	1¼
Floor drain, 2 inch-----	3	2	2	1½
3 inch or larger****-----	4	3	3	2
Laundry tray-----	3	1½	1½	1½
†Refrigerated cases-----	1	1½	1½	1½
Shower stall, each head-----	4	2	2	1½
Sinks, Cup-----	1	1¼	1¼	1¼
Factory wash-up-----	4	1½	1½	1½
Fountain or bar-----	3	1½	1½	1½
Food waste disposers (commercial)-----	2 HP or less	1½ or 2	2	1½
Food waste disposers (commercial)-----	3 HP or more	3	3	2
Laboratory-----	2	1½	1½	1½
Laboratory, school-----	2	1½	1½	1½
Classroom juvenile-----	2	1¼	1½	1½
Plack or plaster-----	4	2	2	1½
Residential (with or without F.W.G.)-----	4	1½	1½	1½
Restaurant, Scullery, pots and pans-----	4	2	2	1½
Food, rinsing, cleaning or thawing-----	3	1½	1½	1½
Service sink, flushing rim-----	6	3	3	2
Service sink, wall outlet-----	4	2	2	1½
Service sink, wall outlet-----	4	3	3	2
Service sink, floor outlet-----	4	2	2	1½
Service sink, floor outlet-----	4	3	3	2
Shampoo sink, barber or beauty parlor-----	2	1¼ or 1½	1½	1½
Surgeons, wash-up-----	3	1½	1½	1½
Sterilizer, Bed pan-----	4	2	2	1½
Garbage can washers-----	3	3	3	2
†Instrument or water-----	1	1¼	1¼	1¼
Urinal, Men-----	4	2	2	1½
Women-----	6	2½	3	2
†Vegetable display cases-----	2	1½	1½	1½
Wash basin-----	1	1¼	1½	1¼
Water closet, tank type-----	6	2	3	2
Water closet, flush valve-----	3	2	3	2

*Based on discharge rate (See section H 62.03 (2).)

**Includes foot, Sitz and infant baths and regular bathtubs with or without showers.

***Based on discharge rates and number of outlets, 4" trap and waste pipe minimum recommended.

****Trap and waste pipe sizes to correspond to floor drains.

†Requires air-gap discharge.

(2) CONTINUOUS FLOW FIXTURES. Fixtures such as pumps and ejectors from which there is continuous or semi-continuous discharge shall have a fixture unit value of one for each one gallon per minute of flow.

(3) **UNIT CAPACITY AND LENGTH OF SANITARY PIPING.** The number of fixture units connected to any stack, branch or vent and the length of piping shall not exceed that shown in the following table for a given diameter of pipe. After maximum length of vent for any given pipe size is reached, the diameter of the pipe shall be increased to the next size.

Table 2
Fixture Unit Capacity and Maximum Water Closets
or Like Fixtures on Soil, Waste or Vent Pipe

Pipe Diameter (Inches)	Soil or Waste				Vent	
	Fix. Units on Vertical Pipe	Water Closets or Like Fixtures on Vertical Pipe	Fix. Units on Horizontal Pipe	Water Closets or Like Fixtures on Horizontal Pipe	Fix. Units on Vent (See lim- itations)	Maximum Length Vent (in feet)
1¼	1		1		1	50
1½	8		4		12	65
2	18		9		24*	85
2½	40		20		60*	105
3	50	2	25*	1	126**	212
4	252	33	126	17	252	300
5	680	80	340	40	680	390
6	1,380	120	690	60	1,380	510
8	3,600	225	1,800	112	3,600	750
10	7,600	400	3,800	200	7,600	---
12	12,000	575	6,000	283	12,000	---

*Limitation of one 6 or 8 fixture unit fixture.

**Limitation of six 6 or 8 fixture unit fixtures.

Table 3
Gravity Condensation Drains Total Number of Connections

Drain Outlet Size	Indirect Main Waste Size							Assigned Fixture Unit Value
	¾	1	1¼	1½	2	2½	3	
1/8	2	4	6	9	16	25	36	0-1/8
3/4	1	1	3	4	7	11	16	0-3/4
1	0	1	1	2	4	6	9	0-1
1¼	0	0	1	1	2	4	6	1
1½	0	0	0	1	2	3	4	2
2	0	0	0	0	1	1	2	5
2½	0	0	0	0	0	1	1	9
3	0	0	0	0	0	0	1	14

History: 1-2-56; r. and recr. Register, October, 1970, No. 178, eff. 11-1-70; am. (1), Register, October, 1971, No. 190, eff. 11-1-71.

H 62.04 Building sewers. (1) PREMISES SERVED. The interior plumbing of each building shall be entirely separate from and independent of that of any other building. All sanitary, storm drainage or special type drainage systems shall be connected, by means of independent connections, with a public or private disposal system.

(a) Private sewage and storm disposal systems shall be disconnected when public sewers become available to a property. The drainage system shall then be connected to the public system.

(b) When a building is razed or otherwise demolished, the building sewers shall be sealed at the property line.

(2) **MATERIALS.** All building sewers shall be constructed of cast iron, vitrified clay, concrete, cement asbestos or bituminous fiber pipe or other materials approved by the department for restricted, tentative or experimental use.

(3) **SIZE.** (a) *Sanitary sewer.* The size of the building sewer shall be determined by the total number of drainage fixture units tributary thereto. The diameter of the building sewer shall be equal to or greater than the size of the building drain. The minimum size of a building sanitary sewer shall be 4 inches. The following table shall apply to sanitary building sewers and building drains.

Table 4

Diameter of Pipe (inches)	Maximum Number of Fixture Units		
	$\frac{1}{8}$ " per ft. Slope	$\frac{1}{4}$ " per ft. Slope	$\frac{1}{2}$ " per ft. Slope
4	115	150	210
5	270	370	540
6	510	720	1,050
8	1,290	1,860	2,640
10	2,520	3,600	5,250
12	4,390	6,300	9,300

(b) *Storm sewer.* The required size of building storm sewers, other exterior drains and lateral branches is to be determined on the basis of the horizontal projection of roofs, yards and other tributary areas to be drained. The building storm sewer shall be of a size to accommodate, under normal flow rate capacities, the entire volume of wastes tributary to same. No building storm sewer shall be less than 4-inch inside diameter.

(4) **INSTALLATION.** (a) *Gradient.* Building sewers shall, where possible, have a slope of one-fourth inch per foot. In no case shall there be less than one-eighth inch per foot unless a minimum velocity of 2 feet per second is attained throughout the sewer by gravity flow. Between the lot line and the sewer main, or riser pipe therefrom, the sewer shall be laid at a uniform slope not exceeding one-half inch per foot. Building sewers 12 inches or larger in diameter may be installed with a grade equal to main interceptors of the same diameter. Where the main sewer in the street has sufficient depth, or where a lot is 3 feet or more above the established grade line, the building sewer between the lot line and the building shall not exceed a gradient of one-half inch per foot except for a change in elevation which shall be made by the use of 45 degree fittings.

(b) *Depth.* Building sewers shall be installed at a depth of not less than 42 inches below finished grade, except that when the building sewer terminates in a septic tank, its depth shall be not less than 18 inches to top of pipe.

(c) *Riser—main sewer.* A riser from the main sewer may be installed to establish the elevation for the building sewer to insure the proper gradient and depth in accord with section H 62.04 (4) (a) and (b).

(d) *Alignment.* All building sewers shall be laid in alignment between fittings. Any changes in grade or direction shall be made with approved "Y's" or long radius fittings. Clipping of pipe or fittings is prohibited.

(e) *Trenching.* All excavations shall be open trench work unless otherwise permitted by local ordinance or accepted by the local inspector.

Note: See sections Ind 6.06, 6.12 and 6.21 concerning timber requirements for trenches and general safety precautions.

(f) *Stable bottom.* Where the bottom of the trench can be maintained in a stable condition and free of water during time of installation of pipe, the building sewer, depending on the type of material used, shall be bedded and be initially backfilled as hereinafter provided. Grade, as used in this subsection, is defined as the elevation of the bottom of the pipe.

1. Concrete, clay, bituminous fiber and asbestos-cement pipe. The trench bottom throughout its length shall be excavated to a depth at least 3 inches below the grade elevation except where sand is encountered and shall be brought back to grade with a sand, gravel, or crushed stone bedding which is tamped in place. The size of the bedding material shall be such that 100% shall pass a one-half inch sieve. The bedding shall be shaped to accommodate pipe bells or couplings. Initial backfill on the sides of the pipe and to a depth of 12 inches over the pipe shall be well tamped sand, gravel, crushed stone or excavated material which is neither corrosive nor organic in nature. The material shall be of such size that 100% shall pass a one-inch sieve. Initial backfill shall be placed in increments not exceeding 6 inches in depth and be well tamped for the full length of the sewer.

2. Cast iron soil pipe. Where the trench bottom does not contain stone larger than one inch in size or where bedrock is not encountered, the trench may be excavated to grade. When stone larger than one inch in size or when bedrock is encountered, the trench shall be excavated to a depth at least three inches below the grade elevation and be brought back to grade with a bedding of sand, gravel, or crushed stone of which 100% shall pass a one-half inch sieve. The bedding material shall be tamped in place. The bedding or trench bottom shall be shaped to accommodate the bells of the pipe. Initial backfill on the sides of the pipe and to a depth of 3 inches over the pipe for that part of the building sewer laid on private property shall be well tamped sand, gravel, crushed stone or excavated material which is neither corrosive nor organic in nature. The material shall be such that 100% shall pass a one-inch sieve. For that portion of the sewer in the street, the initial backfill material to a depth of 12 inches over the pipe shall be sand, gravel or crushed stone of such size that 100% shall pass a one-inch sieve. It shall be placed in increments not exceeding 6 inches and be well tamped.

(g) *Unstable bottom.* Where a mucky or unstable bottom is encountered in the trench, the required dry and stable foundation conditions shall be provided by sheathing driven and left in place to a depth of 48 inches below the trench bottom or to solid foundation at a lesser depth, the removal of wet and yielding material to a depth of 24 inches or to solid material, and replacement of the unstable material

with limestone screenings, pea gravel or equivalent material for the bedding under the pipe. The trench bedding shall be shaped to accommodate pipe bells or couplings. In lieu of the foregoing, the required dry and stable foundation conditions may be provided by installation of a longitudinally reinforced concrete cradle the width of the trench and at least 3 inches thick or by installation of a longitudinally reinforced concrete slab the width of the trench at least 3 inches thick and bedding material as provided for in section H 62.04 (4) (f) 1 and 2. Initial backfill material and its placement shall conform to that specified in section H 62.04 (4) (f) 1 and 2. All sheathing shall be cut off at a depth of 3 feet or more below the ground surface to prevent heaving due to frost action.

(h) *Access.* When building sewers exceed 100 feet in length cleanouts of the same diameter shall be not more than 75 feet apart on piping up to and including 4 inches in diameter; not more than 100 feet apart on piping 5 to 10 inches in diameter. Manholes shall be constructed for main interceptor sewers 12 inches and larger at intervals not to exceed 200 feet, or at each change of direction of more than 45 degrees. All cleanout openings shall extend to finished grade.

(i) *Industrial waste control.* All building sewers serving manufacturing or industrial processing plants or service stations (gas and oil) which are connected to a public sewer system shall have installed therein a manhole for periodic sewage sampling purposes. The manhole shall be of approved design and shall be located on public right-of-way where possible. When manholes are installed on private property they shall be readily accessible at all times.

1. *Location.* Sampling manholes should be located on public property whenever possible. When located on private property they shall be within 5 feet of the lot line fronting on the public right-of-way and authorized representatives shall be guaranteed the right of access.

2. *Construction.* Sampling manholes shall be a minimum of 36 inches in diameter and constructed in a watertight and substantial manner and may be of concrete, precast concrete, cast iron, bituminous fiber, enamel coated 14 gauge steel, or vitrified clay pipe. Construction details shall follow the general criteria as shown in the following sketch:

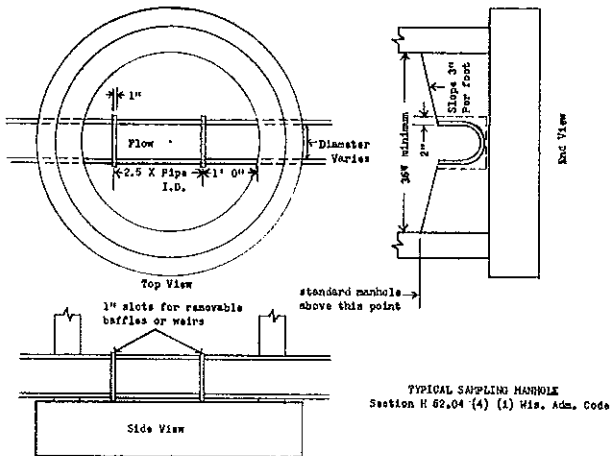

(j) *Backfill completion.* Due care shall be exercised in placing the balance of the backfill to prevent breakage of the pipe. Large boulders or rock or concrete slabs, or frozen masses shall not be used in the backfill nor shall machinery be operated within the trench until a cover of 6 feet over the pipe has been attained.

(5) *INSPECTION.* The building sewer should be inspected upon completion of placement of the pipe and before backfilling. A "T" or "Y" should be provided to permit testing the pipe for leakage or infiltration. Such "T" or "Y" shall be located as near as possible to the point of connection with the street or main sewer.

(6) *CONNECTIONS TO MAIN SEWER.* When a building connection on the street or main sewer is not found within 3 feet of the point designated by the local governing body, or its authorized representative, a "Y" or "T" fitting approved by the department shall be used. The connection shall be set upon or in a carefully cut opening centered in the upper quadrant of the street sewer, and be secured by encasement of the main sewer pipe and the fitting with concrete at least 3 inches thick so as to assure permanency of connection and adequate backing of the street sewer pipe. In lieu of the use of fittings and in the event that the opening cannot be centered in the upper quadrant of the street sewer, a length of the street sewer pipe shall be removed and a "Y" branch section inserted in its place. The joints at the ends of such section shall be encased in concrete at least 3 inches thick. Such connection or insertion shall be made under the supervision of the authorized representative of the municipality.

(7) *SEWER OPENINGS PROTECTED.* The ends of all sewer pipes not immediately connected shall be securely closed so as to prevent the introduction of sand or earth or drainage from an excavation.

(8) *LIMITATIONS AND PROHIBITIONS.* (a) *Location.* The following minimum distances shall be maintained between building sewers and water wells.

1. Sanitary and storm sewers, including sanitary and storm building drains, of cast iron pipe with leaded or neoprene gasket joints—8 feet.

2. Sanitary and storm sewers, including sanitary and storm building drains, other than cast iron—25 feet.

(b) *Use of building sewers.* No person shall connect to a public sewer any building drain or sewer through which is discharged any substance likely to cause undue corrosion, obstruction, nuisance, explosion or interference with sewage treatment processes. See sections H 62.11 and H 62.14.

(c) *Storm and clear water connections.* Roof leaders, surface drains, ground water drains, foundation footing, refrigerator cooling water, storm water drains, drinking fountains, air-conditioning and other clear water drains not described herein shall whenever possible discharge to storm drains or sewers, but they shall not be discharged to a sanitary building drain or sewer or to a private sewage disposal system. Building storm sewers shall not be connected to a building sanitary sewer. The building sanitary sewer and building storm sewer shall be installed as 2 separate pipe lines and shall connect to the appropriate street or main sewer. In the event no main storm sewer exists, the building storm sewer shall extend to the ground surface terminating with a return bend type fitting with the discharge opening 18 inches above final grade. A bleeder drain shall extend to an open bottom catch basin and shall be reduced to a 1 inch inside diameter pipe size or other design methods as may be approved by the department.

History: 1-2-56; am. (10) (b), Register, February, 1957, No. 14, eff. 3-1-57; am. Register, August, 1961, No. 68, eff. 9-1-61; r. and rec. Register, October, 1970, No. 173, eff. 11-1-70; am. (4) (i) 2., Register, October, 1971, No. 190, eff. 11-1-71.

H 62.05 Building drains. (1) **ELEVATION.** All building drains shall be brought into the building underground, preferably below the level of the basement floor.

(2) **MATERIALS.** All building drains shall be constructed of concrete, vitrified clay, type L hard temper copper or cast iron pipe. The use of concrete or vitrified clay pipe is permitted only where there is a soil covering of 18 inches or more or where the pipe is covered with 9 inches of soil and a substantial concrete floor having a minimum 3 inch thickness. Where a building drain leaves the building at a point above the basement floor, it shall be constructed of cast iron or type L hard temper copper pipe to a point 5 feet from the inside of the building foundation wall or to such additional distance as necessary to reach undisturbed stable ground.

(3) **SIZE.** (a) *Sanitary.* The size of building drains and building sub-drains shall be determined by the number of fixture units tributary thereto. The minimum size of a building drain shall be 4 inches. The minimum size of an underground building sub-drain shall be 3 inches. The minimum size of underground waste pipe may be 2 inches in diameter and shall not exceed 4 feet in length. See sections H 62.04 (3) (a) and H 62.08 (7) (a).

(b) *Storm.* The building storm drain size shall be determined on the total area to be drained thereby. The size of the roof leader piping should be determined from the following table or shall be calculated using the formula following the table.

Table 5

Type of Roof	Allowable Roof Area in Square Feet for Given Size of Inside Leader					
	2½"	3"	4"	5"	6"	8"
Roof covered with gravel, slag or similar material with incline ¼" to 1' or less	Up to 1,645	1,646 to 2,120	2,121 to 3,780	3,781 to 5,885	5,886 to 8,490	8,491 to 15,125
Same with incline ½" to 1' or more and sawtoothed roofs	Up to 1,220	1,221 to 1,770	1,771 to 3,150	3,151 to 4,905	4,906 to 7,075	7,076 to 12,600
Metal, tile, brick, slate, or similar roofs of any incline	Up to 975	976 to 1,415	1,416 to 2,520	2,521 to 3,925	3,926 to 5,660	5,661 to 10,080

(c) *Barrett's formula.* For vertical leaders serving roofs covered with gravel or slag, with an incline not exceeding one-quarter of an inch per foot, allow 300 square feet of roof surface to each square inch of leader opening; for roofs of greater incline or sawtooth roof construction, 250 square feet roof surface to each square inch of leader opening; for metal, tile, slate, or similar roofs of any incline, 200 square feet of roof surface to each square inch of leader opening. This formula using the 300 square feet of area for each square inch of leader opening can also be used for determining the size required for draining yards and other areas. To determine the diameter of the vertical leader required, the following formula can be used:

$$\text{vertical leader diameter} = 1.128 \sqrt{\frac{\text{roof area}}{300 \text{ or } 250 \text{ or } 200}}$$

(4) CONTROLLED ROOF DRAINAGE. (a) *Approval.* Storm water roof drainage systems employing or incorporating special types of equipment, devices, weirs or other methods of controlling or delaying flow volume velocities or capacities for the purpose of minimizing pipe diameter requirements shall receive department approval before installation.

(b) *Design.* The system shall be designed using the area rainfall rate criteria, the formulae applicable to the specific manufacturers roof drain equipment to be installed, other pertinent design data and applicable state plumbing code rules.

(c) *Plans.* Blueprints (isometric or schematic) shall be prepared in triplicate for submission to the department for review. The plans shall contain the entire system layout including the building storm drain and storm sewer. All criteria and data pertinent to the proposed installation shall be included with the plans including other clear water waste tributary thereto. The installation shall not be revised or deviate from the approved plan without prior authorization from the department.

(5) BACKFLOW VALVES. Building drains subject to backflow or backwater at the time of installation shall be provided with adequate backwater valves, installed to prevent interference with the flow and be readily accessible for cleaning.

(6) **OTHER REQUIREMENTS.** Installation of building drains shall also conform to section H 62.04 (4) (a) as to gradient section H 62.04 (4) (f) and (g), (7) and (8); sections H 62.15 and H 62.16, insofar as they are applicable and necessary for proper installation.

History: 1-2-56; am. (1), (2) and (3), Register, February, 1957, No. 14, eff. 3-1-57; am. Register, August, 1961, No. 63, eff. 9-1-61; r. and recr. Register, October, 1970, No. 178, eff. 11-1-70; am. (3) (a), Register, October, 1971, No. 190, eff. 11-1-71.

H 62.06 Stacks and branches. (1) **GENERAL.** (a) *Soil or waste stacks required.* Every building in which plumbing is installed shall have at least 1 vertical stack which shall run as directly as possible from the building drain through the roof.

1. Commercial and industrial type buildings. The furthestmost soil or waste stack connected to the building drain shall extend undiminished in size from the stack cleanout fitting to the roof terminal. Where a building is served by more than 1 building drain connecting to separate building sewers, a minimum 3 inch stack shall be installed to serve each building drain.

2. Residential type buildings. The furthestmost soil stack connected to the building drain shall extend undiminished in size from the stack cleanout fitting to the roof terminal. Where a building is served by more than 1 building drain connecting to separate building sewers, a minimum 3 inch stack shall be installed to serve each building drain.

(b) *Size of soil and waste stacks.* All soil and waste stacks shall be sized according to Table 2 except as follows: No soil stack shall be less than 3 inches in diameter from the highest soil fixture connection to the stack cleanout fitting. When a building contains but one stack, its minimum size shall be 3 inches in diameter.

(c) *Stack offsets.* An offset in a vertical soil or waste pipe with a change of direction of 45 degrees or less from the vertical may be sized as a straight vertical stack.

(d) *Stack base connections.* A long sweep $\frac{1}{4}$ bend, two $\frac{1}{8}$ bends, or a wye and $\frac{1}{8}$ or $\frac{1}{6}$ bend or its equivalent shall be used at the base of all vertical soil and waste stacks.

(e) *Soil and waste pipe extensions.* Any pipe extending from a soil or waste pipe shall be carried full size required to serve the fixture connections and shall be vented or revented to conform with the provisions of section H 62.03 (1) and (3).

(f) *Soil and waste pipe protected.* No soil or waste pipe shall be installed or permitted outside a building, or concealed in outside walls or in any place where they may be subjected to freezing temperatures unless provision is made to protect them from frost.

(g) *Roof terminals.* Each soil, waste or vent stack shall be increased to at least 4 inch inside diameter at least 4 inches below the roof and shall extend at least 8 inches to 12 inches above the roof at this point. When the extension is greater than 12 inches or the roof is used for other purposes than weather protection, such extension shall extend not less than 5 feet above the roof. All roof terminals extending more than 12 inches above the roof shall be protected from frost closure.

1. Location. The roof terminal if within 8 feet of any door, roof louver, attic vent, window, scuttle or air shaft shall extend at least 2 feet above same. Vent pipes shall not terminate under the overhang of the building. All roof terminals shall be located a minimum of 20 feet from any air intake unit or device.

(2) **HORIZONTAL SOIL AND WASTE PIPE.** (a) *Size and gradient.* All horizontal soil and waste piping should be sized in accordance with table 2, except that no horizontal waste pipe carrying the discharge of fixtures shall be less than $1\frac{1}{4}$ inches in diameter. The minimum gradient shall be $\frac{1}{4}$ inch per foot wherever possible, in no case shall the grade be less than $\frac{1}{8}$ inch per foot.

(b) *Change in direction.* All changes in direction shall be made by the proper use of 45 degree wyes, long sweep $\frac{1}{4}$ bends, $1/6$, $\frac{1}{8}$ or $1/16$ bends, or with fittings producing a like radius, except that single or double sanitary tees may be used on a vertical stack. Short $\frac{1}{4}$ bends may be used in soil and waste piping where the change in direction of flow is from the horizontal to the vertical and for closet discharge connections.

(c) *Increasesers and reducers.* Where different sizes of pipes, fittings or combinations thereof are to be connected, proper size increasesers or reducers shall be used.

(d) *Fittings.* Fittings in the drainage system shall conform to the type of piping used. Fittings on screwed, threaded or other approved pipe shall be of recessed drainage pattern. All special fittings used in the soil, waste or vent lines shall be submitted to the department for acceptance.

(3) **HANGERS AND SUPPORTS.** Vertical piping shall be substantially supported at 10 foot intervals or floor levels. Provisions shall be made for expansion and contraction of piping and for structural settlement that may affect the piping. Horizontal piping shall be supported at intervals not to exceed 10 feet. Cast iron soil pipe shall be supported at intervals of not more than 5 feet. Supports secured in or against masonry shall be attached with expansion bolts or other approved methods without the use of wood plugs. All piping shall be rigidly secured and supported so that proper alignment will be retained.

(4) **MATERIALS.** All main or branch soil and waste pipes within the building which will be installed above ground shall be of cast iron, galvanized steel, galvanized wrought iron, lead, brass, DWV, "M", "L" or "K" type copper, borosilicate glass or other materials which are deemed acceptable to the department for experimental purposes. Materials installed underground shall be of lead, brass, type "L" or "K" copper, borosilicate glass, cast iron, concrete, vitrified clay or other materials approved by the department for experimental purposes. All pipe materials other than cast iron, concrete or vitrified clay pipe, when installed so as to be embedded in or through concrete, shall be adequately protected by thoroughly applying 2 coats of asphaltum paint or tar paper wrapping or other equivalent means of insulation. For borosilicate glass installed underground, trenching shall be continuous for that portion of the piping which will be below the floor slab. The bottom of the trench shall be constructed so that the pipe will have solid bearing along its entire length. If rock is encountered, the trench shall be undercut 6" and backfilled with sand. All buried glass piping shall be covered with polystyrene casing material. All fittings, connections, and joints shall have equally adequate protection. Backfill to a point 12" over the pipe shall be earth or sand void of rock, concrete slabs, or frozen masses. No galvanized steel or wrought iron soil or waste pipe shall be laid underground. Underground piping shall also conform to section H 62.04 (4) (a) as to gradient, H 62.04 (f) and (g), (7) and (8); section H 62.15 and

H 62.16 insofar as they are applicable and necessary for proper installation. DWV type copper pipe shall not be installed for horizontal piping serving urinals, water closets, bedpan washers, bedpan sterilizers or like fixtures.

(5) FUTURE CONNECTIONS. All openings in soil or waste pipes provided for future fixture connections shall be properly connected, vented and sealed. See section H 62.03 (1) and (3).

History: 1-2-56; am. (2) Register, February, 1957, No. 14, eff. 3-1-57; r. and recr. Register, October, 1971, No. 190, eff. 11-1-71.

H 62.07 Vents. (1) BACK VENTS. A back vent or continuous vent pipe shall be provided to serve each trap except as otherwise specified in this chapter.

(2) CIRCUIT VENTS. A circuit vent may serve a horizontal soil or waste pipe to which 2 and not more than 8 like fixtures are to be connected. See following sketch. For proper fixture connections, see applicable code sections.

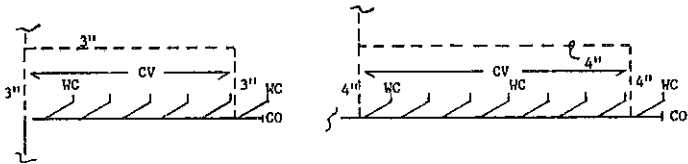

CV = CIRCUIT VENT

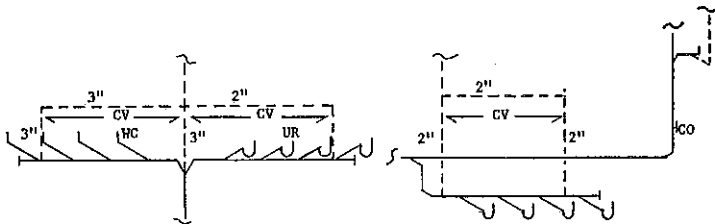

(a) *Size.* The size of the circuit vent shall be determined by the total number of fixture units connected thereto. This subsection shall not apply to floor outlet water closets or bedpan washers or fixtures intended for such uses.

(3) CROWN VENT. In no case shall a vent be connected to the crown of a trap.

(4) LOOP VENT. A single island type or isolated fixture may be served by a loop vent when no other method of venting is possible. See following sketch.

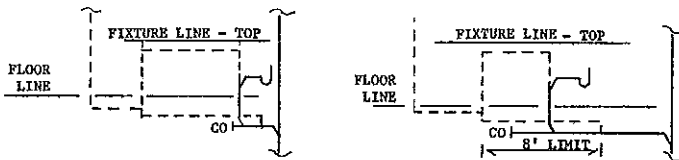

(5) MAIN SOIL OR WASTE VENT. Every building having plumbing fixtures or a plumbing system shall have installed therein at least 1 main soil or waste vent (stack vent) of at least 3 inch inside diameter which shall extend from a soil or waste stack at least 3 inches in diameter to the roof terminal.

(6) MAIN VENT. All vertical soil or waste pipes 3 inches or larger in diameter serving fixtures on 3 or more floor levels shall be provided with a main vent pipe. The size of the main vent shall be determined by the number of fixture units to be served and shall extend full size from the base connection to the point of terminus. See following sketch. See section H 62.03 (1) and (2).

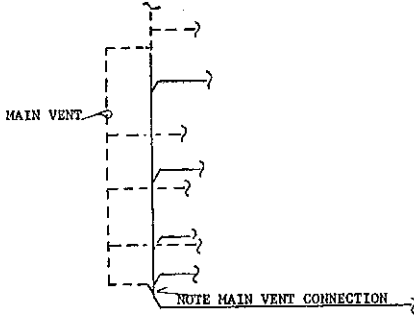

(7) RELIEF VENTS. Where fixtures discharge above a soil or waste pipe served by a circuit vent, each soil or waste pipe shall be provided with a relief vent in the form of a wet or dry vent, taken off ahead of the first fixture, with a diameter of not less than 1½ inches or one-half the diameter of the horizontal soil or waste pipe to which it is connected or whichever is greater. See following sketch.

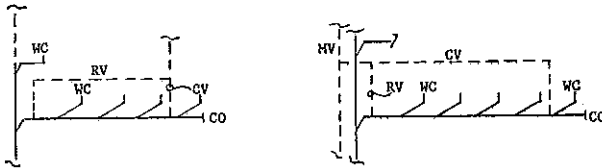

(8) SUDS VENTS. Buildings of 3 stories or more having a separate waste stack to serve clothes washers, dishwashers with or without kitchen sinks shall be provided with a suds vent. See following sketch.

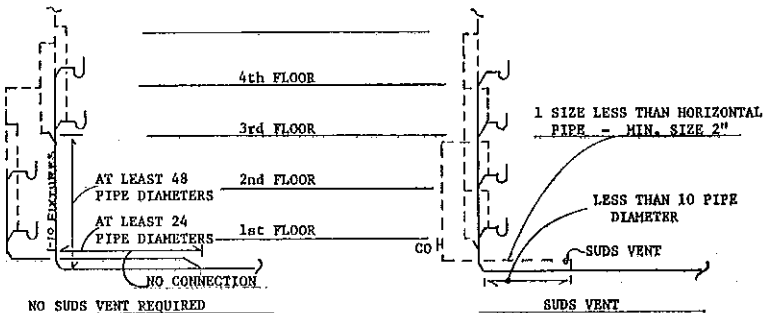

(9) **UNDERGROUND VENT.** Any vent pipe installed underground shall have a minimum inside diameter of 2 inches.

(10) **UNIT VENT.** Two identical fixtures located on the same floor level discharging through the same approved drainage pattern fitting into a vertical soil or waste pipe may be served by a unit vent pipe as hereafter indicated. (Also referred to as a common vent.)

(11) **WET VENT.** Fixtures with a unit value of only one or less may be used to wet vent floor outlet fixtures located on the same floor level as the fixture creating the wet vent.

(12) **YOKE VENT.** All soil and waste pipes served by a main vent in buildings 8 floors or 80 feet or more in height shall be provided with a yoke vent at each 40 foot interval. The size of the yoke vent shall be not less than the size of the smaller pipe to which it connects. The lower end of each such vent shall connect to the soil or waste pipe through a wye below the horizontal branch serving the floor and the upper end shall connect to the main vent pipe through an inverted wye or a tee fitting not less than 3 feet above the floor level. Compute height locations from building drain upward.

(13) **VENT RELOCATION.** Where fixtures are afterwards installed on a soil or waste pipe above existing vent connections to the main soil or waste vent, the vent piping system shall be rearranged to conform to the provisions of this chapter.

(14) **VENT PIPE GRADES AND CONNECTIONS.** All vent pipes shall be free from drops or sags and shall be so graded and connected as to drain back to the soil or waste pipe by gravity. Whenever it becomes necessary to trap a horizontal vent pipe, it shall be drained back into a waste pipe by gravity.

(15) **VENT CONNECTIONS.** All vent pipes shall be run separately through the roof, be connected to other vent pipes or vent stacks a minimum of 4 inches below the roof, or be reconnected to the main vent pipe not less than 38 inches above the highest floor on which fixtures are installed. All changes in direction from vertical to horizontal on any vent shall be made above the overflow rim of the fixture, but not less than 36 inches above the floor wherever possible. No fitting or fittings for future waste connections shall be placed in any soil or waste pipe above the point of revent connection.

(16) **SPECIAL VENTS.** (a) *Blow-off tanks.* Vents serving blow-off tanks or basins shall not be connected to the vent pipe system serving the sanitary drainage system.

(b) *High temperature steam vents.* Vent pipes serving steam operated sterilizers, cleansing or degreasing equipment, pressing machines or any other apparatus which normally discharges steam into a vent shall be connected to a vent which is separate from the plumbing system.

(c) *Chemical piping.* Vent piping serving waste piping systems conveying acids, caustics, chemical or other similar wastes shall be connected to piping materials approved for such use and shall not reconnect to the plumbing vent piping system, but shall extend separately to the atmosphere.

(17) **ALTERNATE VENTING SYSTEMS.** Design of venting arrangements other than set forth in this chapter shall be submitted to the department for approval prior to installation.

(18) **MATERIALS.** Vent piping materials to be installed above ground shall be of cast iron, galvanized steel, galvanized wrought iron, lead, brass, or DWV, "K", "M" or "L" type copper or borosilicate glass. Materials installed underground shall be of cast iron, type "K" or "L" copper, borosilicate glass, brass, galvanized wrought iron, or lead. All pipe materials other than cast iron pipe, when installed so as to be embedded in or through concrete, or other corrosive materials shall be adequately protected by thoroughly applying 2 coats of asphaltum paint or tar paper wrapping, or other equivalent means of insulation. For borosilicate glass installed underground, trenching shall be continuous for that portion of the piping which will be below the floor slab. The bottom of the trench shall be constructed so that the pipe will have solid bearing along its entire length. If rock is encountered, the trench shall be undercut 6" and backfilled with sand. All buried glass piping shall be covered with polystyrene casing material. All fittings, connections, and joints shall have equally adequate protection. Backfill to a point 12" over the pipe shall be earth or sand void of rock, concrete slabs, or frozen masses.

History: 1-2-56; am. (7) (b), Register, February, 1957, No. 14, eff. 3-1-57; r. and recr. Register, October, 1971, No. 190, eff. 11-1-71.

H 62.08 Fixture drain connections. (1) **GENERAL.** (a) *Installation.* All plumbing fixtures shall be installed in a manner to afford easy access for cleaning. Enclosures under or around fixtures shall be provided with a circulation of air. Where possible, all piping from fixtures shall be installed within partitions or walls. Access panels shall be provided wherever faucets, valves or traps are concealed. Backgrounds or fixture carrier supports shall be provided for off the floor type fixtures and for other special conditions.

(b) *Drain connections.* Each fixture shall be provided with a water sealed trap installed as near to the fixture as possible. In no case shall the horizontal distance between the trap outlet opening and vent exceed 24 times the inside diameter of the soil or waste pipe serving an above ground fixture. The total grade of the soil or waste pipe shall not exceed the inside diameter of the pipe. Horizontal waste arms should be avoided wherever possible.

(c) *Vertical distance.* The vertical distance of any waste connection between the top of the fixture strainer or opening to the center line of the horizontal waste pipe shall be as close as possible but shall not exceed 15 inches, except floor drains shall not exceed 24 inches. Floor outlet water closets may have a distance of 36 inches between the water level of the fixture and the center line of the horizontal soil pipe serving same.

(d) *Horizontal distance.* The horizontal distance of any waste connection for a fixture served by a separate trap shall not exceed 12 inches measured from the vertical center line of the trap inlet to the center line of the fixture waste outlet.

(e) *Stacking fittings.* Fixtures shall not be connected to soil or waste pipes through stacking of fittings unless each fixture trap is served by an individual back vent.

(2) **BACK VENTS, NOT REQUIRED.** (a) *Unit vent.* Floor outlet fixtures such as water closets, bedpan washers, bedpan sterilizers, service sinks and like use fixtures, not to exceed 2, located on the same floor level which discharge within point of vent limitations into a

vertically installed combination vented double wye and $\frac{1}{8}$ bend or sanitary tee-cross with no other fixtures discharging into the same pipe above them need not be individually back vented.

(b) *Other fixtures.* Two identical fixtures located on the same floor level discharging through the same approved drainage pattern fitting may be connected to a vertical waste pipe except that double tapped tees and sanitary crosses shall not be used in any food waste disposer connection.

(c) *Basement and sub-basement fixtures.* Floor outlet water closets, shower receptors, floor drains, service sinks, elevator catch basins or swimming pool sump drains, not to exceed 2 or combination of any 2, connected to an underground building drain or subdrain need not be back vented when the developed distance of the horizontal soil or waste pipe does not exceed 48 times the inside diameter of the pipe. Where a vertical soil or waste pipe 3 inches or larger in diameter is involved, the branch connection shall be located 8 feet or more in the direction of flow from the base of such pipe. One fixture shall be the maximum permitted on any unvented horizontal branch. The minimum size branch shall be 3 inch inside diameter.

(d) *Kitchen sinks.* Residential kitchen sink fixtures with or without food waste disposal units, not to exceed 3 in number, located directly above one another on individual floors, may connect to a 3 inch diameter vertical waste pipe and need not be individually back vented. Back to back installations are prohibited under this section unless each combination is individually vented. See following sketch.

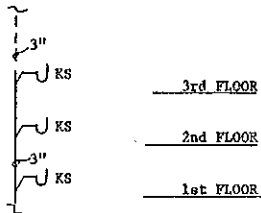

(e) *Other waste connections.* Where separate trapped waste connections from a vented line to each compartment are not installed to serve two-compartment sinks, directional type continuous waste fittings shall be installed. Directional fittings used with a single trap to receive the combined discharge from both sink compartments shall meet all requirements pertaining to venting on the waste discharge side of the trap.

(3) **BAR WASTES.** Bar and soda fountain sinks shall have individual traps and shall connect into a waste pipe which may discharge into an open fixture or receptor through an air-break or air-gap. The total length of the horizontal waste pipe shall not exceed 30 feet. Piping materials may be cast iron, type "L" or "K" copper, galvanized steel, galvanized wrought iron, borosilicate glass or other materials approved by the department. See following sketch.

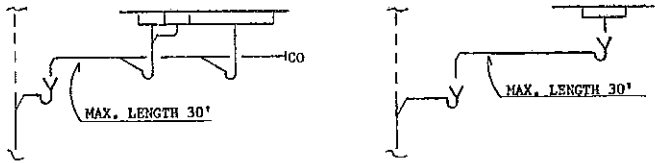

(4) CLOTHES WASHERS. (a) *Residential*. Automatic clothes washers shall discharge indirectly into the drainage system through an air-break type connection. Where a standpipe is used for the point of discharge, the length of the standpipe shall be not less than 20 inches measured from the top of the trap inlet to the top of the standpipe. The top of the pipe shall terminate 2 inches below the flood level of the washer drum.

(b) *Commercial*. Large tumble action or drum type clothes washing equipment should discharge into a floor type receptor through an air-break or by other approved methods having a drain adequate in size to rapidly dispose of the waste water. The size of the drain shall be determined by the manufacturers discharge flow rate and section H 62.03 (2). Interceptor drains shall have a wire basket or other device, removable for cleaning, that will prevent passage into the drainage system of solids $\frac{1}{2}$ inch or larger in size, string, rags, buttons or other materials detrimental to the sewerage system. Laundries having wastes containing oils, sand or other solids shall in addition to the above requirements provide an acceptable means of interception for this material.

(5) DISHWASHERS. Dishwashers shall be installed in compliance with sections H 62.03 (1), (2) and (3).

(6) DRINKING FOUNTAINS. Refrigerated water coolers may connect to the sanitary piping system.

(7) FLOOR DRAINS AND BACKWATER VALVES. (a) *Underground*. All floor drains connecting directly to an underground building drain or building subdrain shall be of cast iron with a water seal of not less than 2 inches and shall have a waterway of not less than 3 inches inside diameter. The unit shall be so constructed, installed and located with the drain inlet in view at all times and so as to provide easy access for cleaning purposes. When such drains are subject to back-flow, they shall be equipped with an approved backwater valve.

(b) *Above ground locations*. Floor drains located above ground may have a 2 inch minimum water seal and inside diameter waterway. The maximum length of an unvented horizontal waste pipe shall be no greater than 24 times its inside diameter.

(8) FOOD WASTE DISPOSERS. (a) *Household disposers*. The minimum size trap, waste pipe and vent to serve a single food waste disposer shall be $1\frac{1}{2}$ inches inside diameter.

(b) *Commercial disposers*. Installations shall comply with the requirements of section H 62.03 (1). For 3 HP or greater capacity or special type units, the manufacturer shall specify the maximum discharge rate of the unit. The size of available waste or building drain and water supply shall be adequate to serve the unit.

(c) *Fittings*. Tapped tees and sanitary crosses shall not be used in any new food waste disposer connection to the waste piping system.

Connection of horizontal waste piping serving waste disposer units to vertical piping less than 4 inches in diameter shall be made by the use of a sanitary tee.

(d) *Prohibited disposer use.* No glass, metal, crockery, stone, gravel, concrete, shellfish shells, plastic, fibrous or other indigestible material shall be introduced into a food waste disposer and be discharged to the drainage system. Eggshells, if in quantities such as might be derived from egg drying and dehydrating plants, may create a serious drainage stoppage and should, therefore, be ground only with sufficient quantities of vegetable materials to cause movement through the drain.

Note: Prior to the installation of food waste disposers in any multiple dwelling, consideration should be directed to the waste piping system for the building, the proposed location and method of connecting the disposers, whether single or two compartment sinks are to be used, the model of the disposer to be installed, as well as any dish-washing machines contemplated and the cold water pipe size and available hydrostatic water pressure.

(9) **FREE STANDING FIXTURES.** Single free standing fixtures such as island sinks, laboratory sinks, etc., may be served by a loop vent and waste pipe type connection. The maximum developed length of the drip section of the loop vent shall not exceed 8 feet. See following sketch.

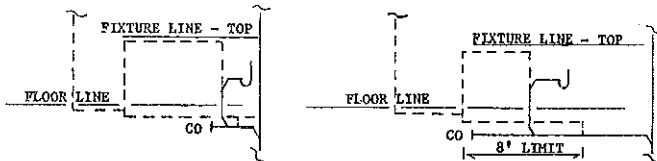

(10) **SPECIAL FIXTURES, EQUIPMENT, DEVICES.** (a) *Special fixtures.* Baptisteries, aquaria, ornamental ponds and fountain basins, industrial wastes and other specialties requiring waste connections or disposition shall be approved by the department prior to installation.

(b) *Bottling establishments.* Bottling plants shall discharge process wastes into an interceptor which will provide for the separation of solids prior to the liquid wastes entering the drainage system.

(c) *Clear water wastes.* Clear water wastes shall discharge to the storm water building drain system through an air-gap.

(d) *Dental cuspidors.* Dental cuspidors when connected to a waste pipe must be effectively trapped and vented as shown in sketch. The length of the horizontal waste pipe between the vent pipe and trap shall not exceed 15 feet. The total fall of the horizontal waste pipe between trap and vent shall not exceed the inside diameter of said waste pipe. See following sketch.

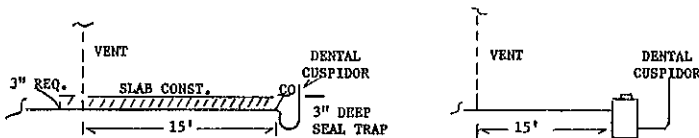

(e) *Drips or drainage outlets.* Appliances, devices, apparatus or appurtenances not regularly classed as plumbing fixtures and not included elsewhere in this code, but which have drips or drainage out-

lets shall be drained by indirect waste pipes discharging into an open receptacle through either an approved air-gap or air-break method.

(f) *Food preparation equipment.* Indirect waste pipe connections shall be provided for steam kettles, steam tables, potato peelers, coffee urns, egg boilers and other types of equipment. The indirect waste shall discharge through an air-gap or air-break, whichever is applicable, into a trapped and vented receptor.

(g) *Garbage can washers.* The drain outlet receiving the wash from garbage cans shall be at least 3 inches in diameter and shall be provided with a removable basket strainer to prevent discharge of large particles into the building drainage system.

(h) *Hydraulic machinery.* Hydraulic motors, hydraulic elevators or other machinery discharging large quantities of wastes shall be detained in a catch basin or receiving tank of sufficient size and so connected as to prevent the discharge of the wastes under pressure.

(i) *Refrigerated equipment.* The waste piping from refrigerators, refrigerated cases, coils or coolers, ice cube machines, vending machines or any equipment, receptacle or room in which provisions are stored shall not connect directly with any drain, soil or waste pipes. These drains shall be trapped as required to preclude their use as a local vent pipe. The length of the special waste pipe shall not exceed 20 feet. Special waste pipes shall be not less than 1 inch in diameter.

(j) *Slaughter houses.* Slaughtering rooms, meat processing and dressing room drains shall be equipped with approved separators or interceptors which will prevent the discharge into the drainage system of feathers, entrails, blood, manure and other materials likely to clog the drainage system. See section H 62 (grease separators).

(k) *Swimming pools.* Pipes carrying waste water from swimming or wading pools, including pool drainage, backwash from filters and water from floor drains which serve decks around pools shall be installed as an indirect waste. Where the recirculation pump is used to discharge waste pool water to the drainage system, the pump discharge shall be installed as an indirect waste to the building drain or sewer. The regulations for sewer connections as established in Wis. Adm. Code chapter H 71 shall apply to private pools.

(1) *Self-service laundries.* Automatic clothes washing equipment in laundrettes, laundromats or other like public laundry establishments shall have the wastes discharge to a building sewer through a manifold with standpipes served by properly sized and vented water sealed traps. The traps may be individually vented or circuit vented. Acceptable methods of installation are indicated in sketches. The following number of washers shall be the maximum to be connected to each size trap:

Table 6

TRAP SIZE (Minimum)	NO. OF WASHERS (Maximum)
2 inch trap	2 machines
3 inch trap	3 machines
4 inch trap	4 machines

Installation of gutters, troughs, local wastes, indirect manifold waste or other such connections are prohibited installations for the above type equipment. See following sketches.

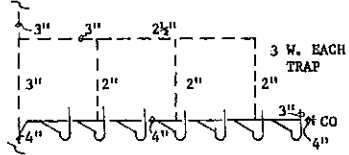
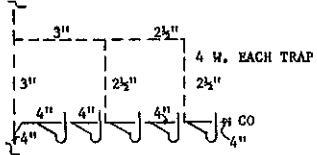
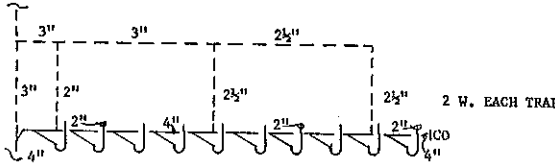
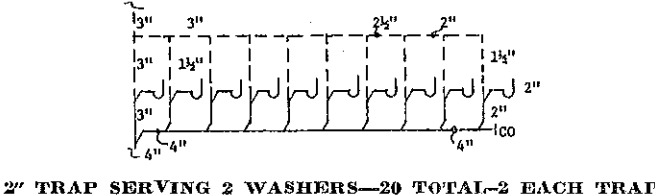
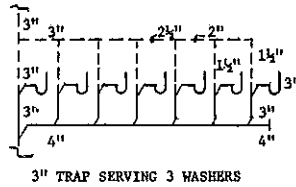
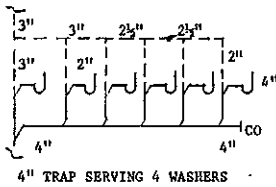

(m) *Vacuum cleaners (central units)*. Plumbing connected central vacuum power cleaning units shall be provided with an acceptable air-gap connection in the water intake pipe. The unit shall be connected to the waste piping system through an air-gap or air-break type connection.

(11) URINALS (a) *Women*. Urinals for women may be installed as an auxiliary or supplementary fixture. This type fixture is not to be used as a substitute for water closets. In all cases the minimum number of water closets required shall be provided.

1. Enclosure. The urinal shall be enclosed with a standard size water closet compartment and door to insure privacy in use. An instruction card explaining how to use the fixture shall be posted in each such compartment.

2. Installation. The fixture shall be installed in accord with all applicable code requirements set forth for water closets. A floor drain shall be installed immediately adjacent to the fixture. The fixture shall

be equipped with an automatic flush tank, automatically controlled flush valve or a satisfactory foot operated flushing device. Every water supply to a urinal (s) shall be protected by an approved type vacuum breaker or other acceptable method.

(b) *Men's urinals*. 1. Stall type urinals shall be set into the floor and the floor shall be graded toward the fixture. A single urinal shall be flushed by an automatic flush tank, an automatically controlled flush valve or a satisfactory foot operated flushing device. A battery of not more than 4 urinals shall be flushed by an automatic flush tank or an automatically controlled flush valve provided the flush pipe is sized and graded as to insure sufficient pressure and volume for adequate flushing at each urinal. Every water supply to a urinal (s) shall be protected by an approved type vacuum breaker or other acceptable method. Batteries of urinals shall be spaced not less than 30 inches center to center. The center line of a single urinal shall be at least 16 inches from the nearest side wall or partition. When the space between stall type urinals or a urinal and a side wall is less than 12 inches, such space shall be filled in flush with the front and top of the urinal with nonabsorbent material.

2. Wall type. a. Wall hanging men's urinals of a type approved by the department may be installed in buildings other than service stations, schools, institutions or places of assembly where children under 12 years old are accommodated.

b. A single urinal shall be flushed by an automatic flush tank, an automatically controlled flush valve or a satisfactory foot operated flushing device. A battery of not more than 4 wall hanging washout urinals shall be flushed by an automatic flush tank or an automatically controlled flush valve provided the flush pipe is sized and graded as to insure sufficient pressure and volume for adequate flushing at each urinal. Every water supply to a urinal (s) shall be protected by an approved type vacuum breaker or other acceptable method.

c. Batteries of wall hanging urinals shall be spaced not less than 30 inches center to center. The center line of a single urinal shall be at least 16 inches from the nearest side wall or partition.

d. The floor space to a point at least one foot in front of the urinal lip and the wall at least 4 feet above the floor and at least one foot on each side of the urinal shall be ceramic tile or other nonabsorbent material.

e. Wall hanging urinals shall be supported by a carrier fitting.

f. Combinations of stall type and wall hanging urinals may be installed.

g. A floor drain located not more than 12 inches from the wall supporting wall hanging urinals, or a stall urinal shall be provided for each group of 4 or less urinals and each toilet room containing a single wall hanging urinal.

h. Fixture unit values, trap, waste and vent sizes shall be the same as men's stall urinals.

i. Excepting for buildings referred to in section H 62.08 (11) (b) 2., any building in which juveniles may be present containing a toilet room having only one water closet and one urinal, the urinal shall be the stall type. If said building contains a toilet room having more than one urinal, at least one urinal shall be installed in accord with section H 62.08 (13) (e).

(12) WATER CLOSETS. (a) *Floor outlet*. One floor outlet water closet may connect to a 3 inch horizontal or vertical soil pipe through a

4 X 3 inch bend. Not more than 2 water closets shall be connected to a 3 inch vertical soil pipe. Offset or 3 X 4 inch closet collar connections are prohibited.

(b) *Back to back floor outlet.* Two water closets located back to back shall be connected to a vertical 3 inch pipe with a 3 inch tee-wye cross. Two floor outlet water closets located back to back may connect to a vertical 4 inch stack through a 4 X 3 inch sanitary cross or through a 4 inch sanitary cross fitting. When fixtures discharge into the same soil pipe above the water closets, all fixtures shall be properly vented. Back to back floor outlet water closets connecting to a horizontal soil pipe shall be connected by the proper use of 45° wyes, double wyes, tee-wye combinations or with fittings producing a like radius and may be circuit vented or individually back vented. See section H 62.08 (1) (c) for vertical limitations.

(c) *Side by side floor outlet.* Floor outlet water closets installed side by side or in batteries shall connect to the horizontal soil pipe through a horizontally installed wye, tee-wye or wye and $\frac{1}{8}$ bend. The fixtures may be individually back vented or circuit vented. Where circuit vents are used, the size shall be: 3 inch for a battery of 2 to 6 fixtures and 4 inch for a battery of 7 or 8 fixtures.

(d) *Wall outlet floor mounted water closets.* Wall outlet floor mounted type water closet fixtures may be connected to a vertical or horizontal soil pipe through an approved type carrier fitting or 4 inch closet collar. When the soil piping is 3 inches in diameter, the pipe connection shall be increased to 4 inch inside diameter between the fixture and soil pipe fitting connections.

(e) *Back to back wall outlet.* Wall outlet, floor mounted type water closets connected to the same vertical soil pipe shall be installed with a fitting so designed as to prevent cross-flow of wastes or air pressures to the opposite fixture, or through an approved type carrier fitting. Where fixtures discharge into the same vertical pipe on floors above, all fixtures shall be properly vented. Wall outlet, floor mounted water closets may discharge into a horizontal soil pipe through an approved type carrier fitting. The water closets may be individually back vented, served by a 3 inch diameter common vent or a 2 inch diameter common vent increased to 3 inches in diameter a minimum vertical distance of 18 inches above the center line of the fixture opening, with no horizontal offset in the vent pipe below a point 38 inches above the floor line.

(f) *Side by side wall outlet.* Wall outlet floor mounted water closet fixtures installed side by side or in batteries shall connect to the horizontal or vertical soil pipe through an approved carrier type fitting, a wye, tee-wye or wye and $\frac{1}{8}$ bend connection. The fixtures shall be individually dry vented.

(g) *Off the floor water closets.* 1. Batteries of side by side off the floor type fixtures shall connect to a horizontal or vertical soil pipe through department approved horizontal or vertical carrier type fittings and shall be individually dry vented.

2. Off the floor type water closets installed back to back shall connect to horizontal soil pipe through a department approved type carrier fitting. The water closets may be individually back vented, served by a 3 inch diameter common vent or a 2 inch diameter common vent increased to 3 inches in diameter a minimum vertical distance of 18 inches above the center line of the fixture opening with no

horizontal offset in the vent pipe below a point 38 inches above the floor line.

(h) *Stack offsets.* Off the floor type water closets shall be connected to a stack offset through an approved back to back carrier type fitting. The installation shall be served by a unit vent of 3 inch or larger diameter, or may be individually back vented in accord with section H 62.03 (1), table 1. Also see section H 62.06 (1) (c).

(i) *Multi-story stacks.* Back to back off the floor water closets shall connect to a vertical soil stack through a department approved back to back carrier type fitting. The water closets may be individually back vented, served by a 3 inch diameter common vent or a 2 inch diameter common vent increased to 3 inches in diameter a minimum vertical distance of 18 inches above the center line of the fixture opening with no horizontal offset in the vent pipe below a point 38 inches above the floor line.

(13) BATHROOM GROUPS. (a) *Bathroom group (single).* A single group of bathroom fixtures may be installed without individual fixture vents in a one story building or on the top floor of a building provided that:

1. The water closet is independently connected to a stack 3 inches or larger with no more than 1 D.F.U. connection above. See following sketch.

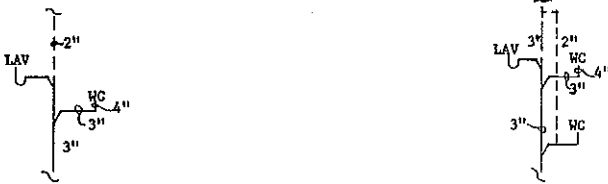

2. The drain from a back vented lavatory serves as a wet vent for a bathtub or shower stall. See following sketch.

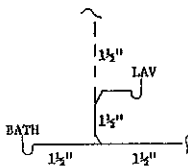

3. Not more than 1 D.F.U. is drained into the 1 1/2 inch vertical vent or not more than 5 D.F.U. drain into the horizontal wet vented pipe. See following sketch.

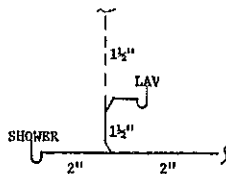

4. The horizontal wet vented pipe shall connect to the stack at or below the same level as the water closet drain when installed on the top floor. See following sketch.



(b) *Double bathroom groups.* Back to back bathroom groups consisting of 2 lavatories and 2 bathtubs or shower stalls may be installed on the same horizontal pipe when served by a 2 inch diameter unit vent provided the water closets (2) connect independently to a 3 inch or larger diameter stack which extends full size without fixture connections above. See following sketches.

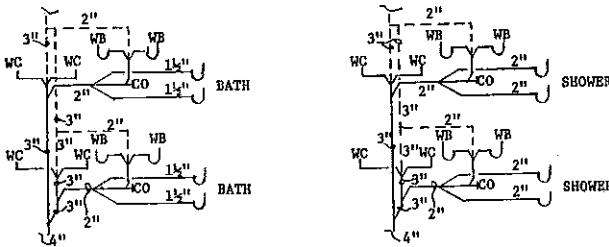

(c) *Other fixtures.* A horizontal soil or waste pipe to which 2 and not more than 8 like fixtures are connected may be vented by a circuit vent. The horizontal soil or waste pipe shall be carried full diameter to the last fixture connection and terminate with a cleanout. See following sketch.

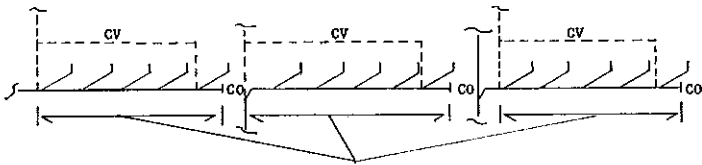

NO CONNECTIONS IN THIS AREA EXCEPT LIKE FIXTURES SERVED BY CIRCUIT VENT.

(d) *Prohibited fixture connections.* There shall be no fixture connection other than the circuit vented fixtures connected to the circuit vented horizontal soil or waste pipe.

(e) *Juvenile fixtures.* Water closets and other fixtures for the use of juveniles shall be of a size and shall be installed at a height suitable for juveniles use. Drain connections shall be provided at height required to serve the fixtures.

(14) **UNLISTED FIXTURES, EQUIPMENT, DEVICES AND APPLIANCES.** For items not included in this section, refer to other applicable sections

of this chapter or contact the department for information and proposed installation review.

(15) **INDIRECT WASTE PIPING AND SPECIAL WASTES. SPECIAL EQUIPMENT, INDIRECT WASTE PIPING.** (a) *Piping by plumber.* The indirect waste piping serving any refrigerator, refrigerator case, icebox, ice compartment, vending machine, rinse sinks, steam tables, steam kettles, potato peelers, egg boilers, coffee urns, appliances, devices or appurtenances in which food or provisions are stored or processed, baptismal founts, clothes washers and extractors, dishwashers, dental cuspidors, garbage can washers, appliances, devices or appurtenances such as stills, sterilizers, bar and soda fountains, boiler blow-off basin outlet drains and similar equipment having public health concern shall be installed by licensed plumbers.

(b) *Piping by equipment installers.* Indirect waste piping serving air-conditioning, cooling coils, air-handling condensate waste, expansion tank overflow and equipment serving steam, power, heating, such as flash tanks, boiler to blow-off basins, machinery wastes, process piping and similar waste piping may be installed by the equipment installer.

History: 1-2-56; r. and recr. Register, October, 1971, No. 190, eff. 11-1-71.

H 62.09 Fixtures. (1) **CONSTRUCTION AND DESIGN.** All fixtures, appliances, equipment, devices and appurtenances shall be of such design, materials and construction as to comply with applicable standards to insure durability, proper service, sanitation, and so as not to entail undue efforts in keeping them clean and in proper operating condition. All fixtures shall connect directly to the sanitary plumbing system except as otherwise indicated. Blowout type fixtures of any type may only be installed upon approval of the department.

(2) **FIXTURE OUTLETS.** Outlet passageway shall be free from impairments and of sufficient size to insure proper discharge of the fixture contents under normal conditions. Outlet connections which are directly connected to the plumbing system shall be such that a permanent air and watertight joint can be readily made between the fixture and drainage system.

(3) **MATERIALS.** Fixtures shall be made of earthenware, vitreous chinaware, enameled steel or ironware, stainless steel or other approved materials. Wooden trays or sinks with or without metallic lining shall be allowed only in commercial laundries and dye houses where such fixtures are in daily use.

(4) **BATHTUBS.** Bathtubs shall be designed in conformity to applicable standards and shall have waste outlets and overflows at least 1½ inches in diameter. The waste outlet shall be equipped with a suitable stopper or closing device. Bathtubs set in any alcove shall have the side with the longest dimension accessible for entry to the tub.

(5) **DRINKING FOUNTAINS AND DEVICES.** Drinking fountains, coolers and like devices shall not be installed in toilet rooms. All drinking fountains, coolers and like devices shall be separate from other fixtures and be made of earthenware, vitreous chinaware, enameled steel or ironware, stainless steel, anodized aluminum, or other approved material. The bowl shall be so designed and proportioned as

to be free from corners so that it may be readily cleaned and so as to prevent unnecessary splashing at the point where the jet stream falls into the bowl. The nozzle shall be of nonoxidizing impervious material and shall have no fouling space or enclosures making cleaning difficult or inducing insanitary conditions. The jet shall be inclined and the orifice shall be higher than the rim of the waste water receiving bowl. The water supply shall be provided with an adjustable valve fitted with a loose key or an automatic self-closing valve permitting regulation of the rate of flow of water. The water supply issuing from the nozzle shall be of sufficient volume and height so that persons using the fountain need not come in direct contact with the nozzle or orifice. To accomplish this the fountain supply should be equipped with an efficient automatic pressure and volume regulating valve.

(6) **LAUNDRY TRAYS, SINKS.** Laundry trays and each sink compartment shall be provided with a waste outlet of at least 1½ inch diameter.

(7) **LAVATORIES (WASH BASIN).** Each fixture shall have a waste outlet of at least 1¼ inch diameter. Each multiple type fixture with 18 inches of useable length of a straight-line or circular type shall be considered equivalent to one lavatory (wash basin) for the purpose of determining the water supply and drainage pipe sizes. Each 18 inch interval and each individual lavatory fixture shall be provided with potable water for hand washing.

(8) **SHOWERS.** (a) *Compartments.* Shower compartments shall have at least 900 square inches of floor area, curb at least 3 inches in height and shall be at least 30 inch in minimum dimension at any given side or angular shape or as the diameter of a circle except when a bathtub is used as the shower compartment. The wall area above built-in tub showers and in shower compartments shall be constructed of smooth, noncorrodible, nonabsorbent, waterproof materials to a height of at least 6 feet above the floor level. The walls shall form a watertight joint with each other and with either the tub, receptor or shower floor. Preformed and prefabricated units shall comply with this subsection.

(b) *Waste outlet.* Waste outlets serving single showers, other than those in bathtubs, shall be at least 2 inches in diameter. When gang showers are to be served, the minimum drain outlet shall be 3 inches in diameter. Strainer perforations or slots shall be no smaller than ¼ inch. Where gang showers are installed, the waste outlet should be so located and the floor so pitched that waste water from one shower head does not flow over the floor area serving another shower head.

(c) *Safing.* All shower stalls, shower rooms, floor setting service sinks or receptors, sunken bathtubs or other like fixtures shall be provided with 4 pound sheet lead asphaltum coated, compotite, copper, saraloy or other approved safing material beneath the entire fixture or room and upward along the sides to a minimum of 6 inches above the curb or maximum water level of the fixture. The corners shall be safed to a height of 6 feet and at least 3 inches in each direction from the corners. The safing shall be properly drained. Unitized receptors, manufactured floor setting service sinks, shower receptors, bathtubs and installations directly over an unexcavated portion of a building are exempt from safing requirements.

(d) *Shower drains and floor drains.* Shower drains and floor drains shall be considered a fixture and shall be provided with an approved strainer.

(9) **URINALS.** (a) *General.* Urinals shall be made of material impervious to moisture and which will not corrode under the action of urine, be of such design, materials and construction that they may be properly flushed and kept in a sanitary condition. If cast iron is used in the construction of urinals, it must be enameled on the inside and coated with durable paint or be enameled on the outside. No sheet iron urinals will be permitted. Only individual urinals shall be used in public buildings and places of employment. Such individual urinals shall be of vitreous china or stainless steel and shall be equipped with an automatic flushing device.

(10) **WATER CLOSETS.** (a) *General.* All water closets shall be designed to meet specifications standards for land use fixtures. They shall hold a sufficient quantity of water and be of such shape and form that no fecal matter will collect on the surface of the bowl. All water closet bowls shall be equipped with adequate flushing rims so as to flush and scour the bowl properly when discharged. Water closets in public buildings shall be of the elongated or extended lip design and shall be equipped with similar design open front seats less cover. For institutions, see applicable sections.

(b) *Side inlet water closet bowls.* New water closet installations shall not be equipped with side inlet openings.

(c) *Fixture flushing.* Each water closet shall be individually equipped with an acceptable flush tank and fittings or with an approved flushometer valve. All flush tanks, flushometer or automatic flushing device shall be readily accessible for maintenance and repair. Ballcocks shall be of the anti-siphon type.

(d) *Prohibited water closet fixtures.* It shall be unlawful to install and/or maintain pan, plunger, offset washout, long hopper, frostproof and/or other water closets having invisible seals or unventilated spaces or walls not thoroughly cleansed at each flushing.

(11) **OVERFLOWS.** (a) *Design.* In any fixture which is provided with an overflow, the waste outlet shall be designed and installed so that the standing water in the fixture cannot rise in the overflow when the stopper is closed, nor shall any water remain in the overflow when the fixture is empty.

(b) *Connection of overflows.* The overflow from any fixture shall discharge into the drainage system on the inlet or fixture side of the trap provided that the overflow from a flush tank serving a water closet or urinal shall discharge into the fixture served.

(12) **WATER HEATERS AND HOT WATER STORAGE TANKS.** (a) *General.* All water heaters either for domestic or industrial use shall be of an approved type and shall connect to the water distribution system in an approved manner. All heaters except electric heaters shall be provided with a flue of rust resistant material connected to a chimney or gas vent stack. All water heaters shall be permanently marked with the rated input of the heater in B.T.U. or watts. Such marking shall be in an accessible position on the outside of the heater for inspection purposes.

(b) *Safety devices.* All safety devices, except mixing valves, shall meet the current requirements of one or more of the following: Amer-

ican Gas Association, Underwriters Laboratories, Inc., American Society of Mechanical Engineers or National Board of Boiler and Pressure Vessel Inspectors. Test and certification by a laboratory in accordance with one of the above applicable standards shall also be considered acceptable. All water safety devices shall be of the temperature and pressure type installed in accordance with this code.

Note: The above standards are on file in the offices of Health and Social Services, Secretary of State, and Revisor of Statutes, and may also be obtained for personal use as follows:

1) Approval requirements for gas water heaters, volume I, Seventeenth Edition, 1965.

Approval requirements for gas water heaters, volume II, effective January 1, 1963.

Approval requirements for gas water heaters, volume III, third edition, 1965. Listing requirements for relief valves and automatic gas shutoff devices for hot water supply systems, effective January 1, 1965 and addenda effective January 1, 1966.

The above standards are available from American Gas Association, Inc., 605 Third Avenue, New York, New York 10016.

2) Standards for safety, household electric storage-tank water heaters, UL 174, third edition, May 1, 1970, and revision pages dated June 16, 1971, January 18, 1971.

The above standards are available from:

Underwriters' Laboratories, Inc.
207 E. Ohio Street, Chicago, Ill. 60611
333 Pfingsten Road, Northbrook, Ill. 60062
1655 Scott Blvd., Santa Clara, Calif. 95050
1285 Walt Whitman Road, Melville, L. I., N. Y. 11746

3) ASME Boiler and Pressure Vessel Codes, Heating Boilers, section IV, 1971, available from American Society of Mechanical Engineers, 29 W. 39th Street, New York, N. Y. 10018.

4) Relieving capacities of safety valves and relief valves, January 1, 1970.

The above standards are available from The National Board of Boiler and Pressure Vessel Inspectors, 1155 N. High Street, Columbus, Ohio 43201.

(c) *Tank construction.* Storage tanks for direct fired storage type water heaters shall be constructed to withstand a minimum of 300 psi test pressure without leakage or permanent distortion and shall bear the manufacturers' marking showing test and working pressure, except that in lieu thereof, pressure markings appearing on AGA or UL listed water heater units will be considered acceptable.

History: 1-2-56; r. and rec. Register, October, 1971, No. 190, eff. 11-1-71.

H 62.10 Traps and cleanouts. (1) **TRAP SIPHONAGE.** Every fixture trap seal shall be protected to prevent siphonage or back pressure by insuring air circulation with an approved vent in compliance with this code. In no case shall a vent be connected at the crown of a trap.

(2) **TRAP CONSTRUCTION.** (a) *Design.* No trap which depends upon the action of movable parts for its seal shall be used. No trap shall be used which depends upon concealed interior partitions for its seal unless such interior partitions are made of indestructible material. No trap shall be used which in case of defect would allow the passage of sewer air. No rubber or wicking packed slip joint connection shall be installed on the sewer side of a fixture trap. Slip joint waste connections on the sewer side of the trap shall be ground faced or equal and shall not be concealed or enclosed.

(b) *Cleansing.* Every trap shall be self-cleaning. Floating and sedimentary solids in the seal of the trap shall be removed by a normal discharge from the connected fixture. Uniform diameter traps shall be considered self-cleaning.

Register, October, 1971, No. 190

(c) *Material.* The material for traps shall be either vitreous china, clay, lead, brass, copper, borosilicate glass, cast iron or malleable iron. Cast iron traps shall be coated on the inside and outside with rustproof coating.

(d) *Depth of seal.* The water seal of all fixture traps shall be at least 2 inches. A deep seal trap shall have a water seal of 4 inches.

(e) *Approval.* Every trap, P.O. plug and trap extension tubing shall have the maker's name, or registered trademark, cast or stamped upon the exterior surface thereof. Traps varying from standard design shall have the approval of the department before being used in any installation.

(3) TRAP INSTALLATIONS. (a) *Setting of traps.* All traps shall be so located as to be accessible, rigidly supported and set true with respect to their water level and so located as to protect their seals, and where necessary, shall be protected from freezing and evaporation.

(b) *Traps where prohibited.* No fixture shall be double trapped and there shall be no traps at the base of soil or waste stacks.

(c) *Bath traps.* Drum traps not less than 4 inches in diameter and having a seal of not less than 2 inches may be used under all bathtubs wherever practicable. The horizontal distance between the vertical center line of the drum trap inlet to the center line of the fixture waste outlet shall not exceed 12 inches.

(d) *Deep seal traps.* Deep seal resealing traps of the centrifugal, self-scouring type may be used when it is impractical to provide a proper back vent. So far as practical a free circulation of air shall be provided. Traps of this type shall not be permitted in new construction or reconstruction.

(4) PROHIBITED TRAPS. Bell, pot, and bottle traps, $\frac{3}{4}$ "S", full "S" type traps, traps fabricated from fittings, crown vented traps and traps constructed of masonry are not permitted.

(5) CLEANOUTS. (a) *Size.* Cleanouts shall be the same size as the pipes to be serviced.

(b) *Building drain.* A cleanout with brass screw cover or other type approved by the department shall be provided at a point where the building drain leaves the building. This cleanout shall be extended from the building drain with a cast iron soil pipe to the surface of the finished floor or grade and wherever practical shall be not less than 2 inches above the finished floor or grade. An additional cleanout located at a point 28 to 30 inches above the floor shall be provided in all soil and waste stacks.

(c) *Toilet and washrooms.* Cleanouts shall be provided in connection with batteries of water closets, urinals, wash basins, sinks and showers, at such points that all parts of the branch waste and soil pipes may be reached conveniently for cleaning or removal of stoppages.

(d) *Sink wastes.* Waste pipes from sinks or other similar fixtures discharging greasy wastes shall have sufficient accessible cleanouts spread over their entire length.

(6) TRAP CLEANOUTS. All fixture traps shall be so designed and installed that stoppages may be removed. All small fixture traps shall be provided with cleanouts of the screw plug or removable dip type. Where the "U" or dip is removable the coupling nut on the discharge side shall be within the dip of the trap. Traps for urinals rising from

the floor and traps serving shower baths and floor drains, when inaccessible, shall be so installed as to make the removable inlet serve as a cleanout.

(7) **CONSTRUCTION.** The bodies of cleanout ferrules shall be made of cast iron or brass and shall extend not less than $\frac{1}{4}$ inch above the hub receiving it. When solid brass screw caps for cleanouts are used, they shall be at least $\frac{3}{16}$ inch in thickness and provided with standard pipe threads and one inch square or hexagonal solid head at least $\frac{3}{4}$ inch high or adequate inverted countersunk sockets. The ferrules when constructed of brass shall be at least $\frac{3}{16}$ inch in thickness and when constructed of iron the same weight per foot as for cast iron soil pipe. The screw thread shall have at least 5 threads of iron pipe size. The tops of cleanout plugs shall be tool faced to a flawless smooth surface so as to insure a tight joint. A brass plug of standard pipe size shall be used where cast iron threaded drainage fittings serve as cleanout openings.

History: 1-2-56; am. (1), (4) and (5), Register, February, 1957, No. 14, eff. 3-1-57; r. and recr., Register, October, 1971, No. 190, eff. 11-1-71.

H 62.11 Catch basin, sumps, ejectors. (1) CONSTRUCTION OF CATCH BASIN. Catch basins shall be constructed in a water tight and substantial manner of brick, cement, concrete, cast iron, bitumastic enamel coated 14 gauge steel or wrought iron or vitrified clay pipe. The outlet shall be provided with a cast iron sanitary tee not less than 4 inches in diameter and be submerged not less than 6 inches below the flow or water line. A 4-inch cleanout shall be provided on the tee. The basin shall have a stone, cement or cast iron cover. No catch basin shall be located within 25 feet of any well. Catch basins shall be constructed according to the use for which they are intended. When connected to a sanitary sewer they shall be located and designed so as to exclude storm water.

(2) **GREASE SEPARATORS.** (a) *When required.* Grease catch basins or interceptors of a capacity based upon the temperature and amount of water tributary shall be installed wherever kitchen or other greasy wastes from hotels, restaurants, club houses, boarding houses, public institutions, hospitals or other similar places are discharged into a house drain or sewer. Garbage disposal units should not be tributary to catch basins or interceptors.

(b) *Location.* Whenever possible, grease catch basins shall be installed outside the wall of the building, as near as possible to the fixtures from which it receives the discharge. Such basin shall be protected against freezing. See H 62.22 (27), (28).

(c) *Capacity.* The liquid content capacity in gallons shall be not less than the flow tributary during any one hour, based upon an allowance of from 2 to 4 gallons of waste water per meal served.

(d) *Construction.* Grease catch basins shall be constructed in the same general manner as provided for catch basins. The inlet and outlet shall be placed as far apart as possible and the depth below outlet flow line shall be not less than 2 feet. The inlet shall not be submerged, and not be more than 12 inches above the flow line of the outlet invert. Grease catch basins when located inside of buildings, shall be provided with a removable air-tight stone, cement or cast iron cover. When bolted covers are provided, the bolts shall be of a non-corrosive metal. See H 62.22 (27).

Register, October, 1971, No. 190

(e) *Commercial interceptors.* Grease basins of this type shall have sufficient capacity, and be properly installed and maintained so they will serve the purpose for which intended. Iron grease traps shall be made of not less than 12 gauge copper bearing steel, pure iron or cast iron. Manufacturers ratings will be acceptable when approved by the board.

(f) *Maintenance.* Cleaning and removal of grease, sediment, or foreign matter which may prevent the satisfactory operation of the interceptor or basin, shall be performed at intervals of such frequency as to prevent the entrance of grease or foreign matter into the drainage system.

(3) **YARD CATCH BASINS.** A yard catch basin shall be constructed in the same general manner as provided for catch basins; they shall be at least 24 inches in diameter, and where possible the outlet shall be at least 4 feet below the surface of the ground or as nearly so as grade of house drain will permit. The outlet invert shall be submerged not less than 6 inches below the water line. The flow or water line shall not be less than 2 feet above the bottom. A yard catch basin may be installed to receive surface drainage or discharge from a pump, hydrant or other outside areas. It may connect only with a storm or combination sewer. See H 62.22 (29).

(4) **STABLE CATCH BASINS.** When liquid wastes from barns, stables, manure pits, and yards are permitted to enter the public sewer system, they shall be intercepted by a catch basin. See H 62.22 (29).

(5) **GARAGE REFUSE SEPARATORS.** (a) *Where required.* All liquid wastes, sand and grit from public garages, service pits and paved areas adjoining service pits, which come in contact with kerosene, gasoline, benzine, naphtha or other inflammable oils or compounds, shall be intercepted before entering the house drain or sewer, by an approved catch basin properly trapped. Gasoline and oil interceptors approved by the board may be installed.

(b) *Capacity.* Garage catch basins or sand traps shall be of a size sufficient to retain the sand and dirt washings reaching the basin during any 10-hour period. The basin shall have a minimum width of not less than 24 inches, and a depth below the water level of not less than 24 inches. See H 62.22 (30).

(c) *Construction.* Construction of garage catch basins or sand traps, shall conform to general requirements for catch basins. The outlet invert shall enter the walls of the basin so that the space between the water line in the basin and the floor level shall not exceed 10 inches. The outlet shall consist of a cast iron sanitary tee laid horizontally with a depth of invert of not less than 6 inches below the water line. The invert shall be provided with a 4-inch cleanout. An open bar strainer not less than 16 inches in diameter shall be provided. Where it is impractical to keep the outlet within 10 inches of the floor level a greater distance will be permitted. In all such installations a 4-inch local vent pipe shall be provided. Such local vent pipe shall enter the basin above the water line. Same shall terminate through roof or with a return bend outside of the building not less than one foot above the grade level. Where a vertical local vent pipe is installed, properly intercepted floor drains will be permitted to be connected thereto provided the total distance does not

exceed 50 feet. Conductors or rain water leaders will not be permitted to act as local vent pipes.

(d) *Cleaning.* Garage catch basins or interceptors shall have the accumulated oil, gasoline or other inflammable fluids, sand, silt or other solids removed at regular intervals.

(6) **SUMPS.** (a) *Location.* All house drains discharging below the flow line of the main sewer, shall discharge into an air and water tight sump or receiving tank, so located as to receive the drainage by gravity, from which sump or receiving tanks the drainage shall be lifted and discharged into the house drain or sewer by pumps, ejectors or any equally efficient method. All sumps installed for the purpose of receiving clear water, basement or foundation drainage water, sink or laundry tray waste shall be located at least 15 feet from any water well. All other sumps shall be located at least 25 feet from any water well.

(b) *Capacity.* The capacity of a sump or receiving tank shall be determined by computing all possible drainage tributary to the sump, including foundation drainage, boiler blowoffs, basement areas to be drained, depth of basement below house drain outlet, locations near a river or lake, soil conditions and types and number of fixtures.

(c) *Air inlet.* Any sump receiving domestic wastes shall have a fresh air inlet. The size of the air inlet pipe required will depend upon the size of the sump, varying from 2 inches to 6 inches. The air inlet pipe may be connected to a plumbing system vent pipe or extended separately to conform with the provisions of this code.

(d) *Vent.* The drain leading to a sump or receiving tank shall, when a closet or closets are installed, be provided with a vent stack not less than 3 inches in diameter. Where fixtures other than closets are installed the vent pipe size shall be determined from the tables in H 62.03 (1) and (3).

(7) **EJECTORS.** (a) *Where required.* In all buildings in which the whole or a part of the plumbing and drainage system lies below the flow line of the main sewer, the sewage, house wastes, foundation drainage, and seepage, shall be lifted by mechanical means, and discharged into the main sewer, house drain or house sewer, or properly trapped fixture.

(b) *Size.* The size and design of an ejector pump shall be determined by the capacity of the sump to be served, the discharge head and discharge frequency. Manufacturers ratings may be used.

(c) *Discharge connections.* The discharge pipe from the ejector to the building drain shall be connected through a branch Y fitting. The drain into which the ejector discharges shall be of sufficient size to receive the combined flow from the building and the ejector. Flanged connections and long radius fittings should be used.

(d) *Check valves.* Horizontal check valves shall be installed in each discharge line. Such valves may be omitted where the discharge pipe forms a loop 2 feet or more above the building drain and is provided with an adequate vent pipe to break the siphon action. When the drain is subject to backflow a check valve shall be used.

(e) *Fixture connections. Venting.* Fixtures located on a house drain near the point where such house drain receives the discharge from an ejector shall be effectively protected against siphonage, and

an additional air relief or vent pipe shall be provided where necessary. No fixtures shall be connected to the discharge pipe from an ejector, between the ejector and the point where it enters the house drain or sewer.

(f) *Maintenance.* All such ejectors and like appliances shall receive care as needed to keep them in a satisfactory operating condition.

H 62.12 History: 1-2-56; r. Register, October, 1971, No. 190, eff. 11-1-71.

H 62.13 *Rain water connections.* (1) **RAIN WATER DISPOSAL.** Where no storm sewer is accessible, surface inlets and rain water conductors should be drained separately to the curb line where practicable by drain pipes not less than 4 inches in diameter, and discharge into the public gutter, unless permitted to drain elsewhere. See H 62.04 (10) (b).

(2) **INSTALLATION DETAILS.** (a) *Inside leaders.* All roof leaders placed within the walls of any building, in an interior court, ventilating or pipe shaft, shall be installed as specified for soil, waste and vent pipes when connected to a combination sewer or drain. Rain water leaders shall not be used as soil, waste or vent pipes; nor shall any soil, waste or vent pipes be used as rain water leaders. Outside catch basins, garage drains, area drains and subsoil drains installed in compliance with the provisions of this code may be connected to conductors at a point more than 4 feet below grade level.

(b) *Rain water connected to storm sewers.* Rain water leaders within a building connecting to storm sewers shall be treated in the same manner as those entering a combination system, except that pipe used in construction may be cast iron, galvanized, asphaltum coated or black iron pipe.

(c) *Connection to drains.* When rain water leaders are connected to house drains within the building, the horizontal part extending 2 feet inside the basement wall and the vertical portion outside the building wall shall terminate with the hub above grade line, and shall be made of cast iron of same weight and durability as provided for house drains. See H 62.22 (32).

(d) *Roof terminal connections.* Connections between gutters, troughs, roof areas, and rain water leaders inside the building shall be made of durable materials. The term "durable" material as used in this section shall mean a brass ferrule, a brass soldering nipple, light lead pipe, 12 oz. copper, No. 18 gauge brass or cast iron receivers properly connected.

(e) *Defective rain water leaders.* When an existing rain water leader within the walls of any building becomes defective, such leader shall be replaced by one which conforms to the requirements of this code.

(3) **CISTERN OVERFLOW.** Overflow pipe from cisterns shall not connect directly with any house sewer, but shall discharge into an open fixture, catch basin or floor drain. Overflow pipes from cisterns, however, shall not discharge into sanitary sewers.

H 62.14 *Special requirements.* (1) **TOILET ROOM VENTILATION.** All toilet rooms and bathrooms shall have at least one outside window that may be opened or be provided with local vent pipes or air shafts extending to the outside air. Local vents or air shafts for toilet rooms shall not be connected with the plumbing system, and must be so installed as to provide adequate ventilation. See H 62.15 (14).

(8) **ACID WASTES.** (a) *Neutralizing basins.* Where it is necessary to dilute or neutralize acid wastes to properly protect the piping of a drainage system, all acid wastes from sinks or other receptacles shall discharge into a catch basin or neutralizing basin of a capacity sufficient to properly dilute or neutralize such wastes.

(b) *Piping.* The waste pipes and traps for acid tanks, sinks and other receptacles receiving the discharge of acids in chemical laboratories, electrotyping, lithographing and other similar establishments must be made of extra heavy acid resisting or acid proof type, extra heavy lead pipe, or lead-lined iron pipe of adequate durability. The waste pipes when serving as a local conveyor between acid tank, dilution tank or other receiving basin may be of asbestos cement pipe and fittings or of vitrified clay incased in concrete of substantial construction or its equal and provided with a vent pipe to the open air where necessary. See H 62.15 (14).

(9) **BOILER BLOWOFF BASIN.** All exhaust, blowoff, sediment or drip pipe connections from a high pressure steam boiler, shall not be connected to any house sewer or drain, without first being cooled to a temperature below 140° Fahrenheit in a suitable tank, catch basin, or other cooling device. The capacity of the catch basin or other cooling devices shall depend upon the steam pressure carried, the size of the boiler, and method of operation. The capacity of such basin shall be sufficient to hold at least one gauge of the boiler. All cooling devices when receiving the blowoff from such boilers shall be provided with a relief pipe, extended independently to the outer air. The size of the relief pipe shall be equal to the threaded opening provided in the cover of the basin.

(10) **PIPE BENDING PROHIBITED.** Bending of brass, galvanized steel or galvanized wrought iron pipe is prohibited. See section H 63.04.

History: 1-2-56; r. (2) through (7), Register, October, 1971, No. 190, eff. 11-1-71.

H 62.15 Materials. (1) **QUALITY.** All material used in any drainage or plumbing system, or part thereof, shall be free from defects that impair service.

(2) **LABELING.** Each length of pipe, fitting, trap, fixture, and device used in a plumbing or drainage system, shall be stamped or indelibly marked with the weight, or quality thereof, and the maker's mark or name.

(3) **SEWER AND DRAIN PIPE.** (a) Asbestos-cement building sewer pipe and fittings shall be fabricated from material consisting of a mixture of portland cement, or portland pozzolana cement, and asbestos fiber, with or without the addition of curing agents. The pipe shall be free from organic substance and shall be formed under pressure, be thoroughly cured and meet the following requirements:

1. The pipe shall show no signs of leaking, weeping, or cracking when tested for general soundness and strength by subjection to an internal hydrostatic pressure of 50 pounds per square inch. The test shall be conducted by placing the pipe in a pressure testing machine with gaskets which seal the ends of the pipe and exert no end pressure. All air shall be expelled from the pipe and the internal water pressure increased at a steady rate to the specified hydrostatic test pressure.

2. Test pipe specimens shall have a crushing strength such that

they shall not fail until the total applied load exceeds the tabular values given in the following table for the size of pipe being tested. The specimens shall be tested by the 3-edge bearing method. The two lower bearings shall consist of 2 straight wooden strips with vertical sides, each strip having its interior top corner rounded to a radius of approximately $\frac{1}{2}$ inch. The strips shall be securely fastened to a block with their interior vertical sides parallel and a distance apart of not less than $\frac{1}{2}$ inch nor more than one inch per foot of diameter of pipe. The upper bearing shall be a wooden block, not less than 6 by 6 inches in cross section, straight and true from end to end. The upper and lower bearings shall extend the full length of the specimen. The test load shall be applied in such a way as to leave free movement in a vertical plane passing midway between the lower bearings. The rate of loading shall be 2,000 pounds per minute per lineal foot, with a tolerance of plus or minus 500 pounds per minute per lineal foot. The breaking load shall be determined. For sewers laid at a depth of 12 feet or more the crushing strength per foot shall be at least 2,400 pounds for 4 inch to 8 inch pipe, 2,800 pounds for 10 inch pipe, and 3,000 pounds for 12 inch pipe.

Size Inches	Flexural Strength 9 Foot Span Pounds	Crushing Strength 3-edge Method Pounds per Foot
4	550	1,740
5	950	1,680
6	1,475	1,420
8		2,500
10		2,200
12		2,200

3. The pipe shall be of uniform structure throughout and such that it may be cut, drilled and tapped.

4. Couplings shall be of the same crushing strength and general soundness as specified for the pipe. The necessary rubber rings shall be furnished with each coupling.

5. Each pipe shall be free from bulges, dents, and tears on the inside surface which result in a variation in diameter greater than $\frac{3}{16}$ inch from that obtained on adjacent unaffected portions of the surface.

6. The exterior edge of the ends of the pipe which extend into the coupling area shall be free from axial chips having a length greater than $\frac{1}{2}$ inch, a width greater than $\frac{1}{2}$ inch, or a depth greater than $\frac{1}{8}$ inch. Similarly, the interior edge shall be free from axial chips having a length greater than one inch, a width greater than one inch, or a depth greater than $\frac{1}{8}$ inch.

(b) Cast iron pipe and fittings shall be coated pipe conforming to Commercial Standard CS 188-59, United States Department of Commerce, and the following requirements:

1. Weights. Use of service weight pipe shall be limited to buildings 5 stories or less in height. Extra heavy weight pipe shall be used in buildings 6 stories or more in height. Wall thickness of fittings and the hubs shall correspond with that of the pipe of the same size and kind.

2. Bends. When direction of flow changes from horizontal to vertical the radius of bends shall be as follows: (All dimensions are given as inches)

Size of pipe	2	3	4	5	6
Minimum radius	3	3½	4	4½	5

When direction of flow changes from vertical to horizontal or when it is at right angles and changes in the same horizontal plane the radius of bends shall be as follows: (All dimensions are given as inches)

Size of pipe	2	3	4	5	6
Minimum radius	8	8½	9	9½	10

(c) Concrete pipe and fittings shall conform to A.S.T.M. "Standard Specifications for Concrete Sewer Pipe," serial designation C-14-59. Extra strength pipe shall be used for sewers laid at a depth of 12 feet or more. For pipe 27 inches or larger in diameter, the pipe shall conform to serial designation, C-76-60T.

(d) Copper pipe and fittings shall conform to A.S.T.M. "Standard Specifications for Seamless Copper Water Tube" (TYPE L) serial designation B-88-58.

(e) Vitrified clay pipe and fittings shall conform to A.S.T.M. "Standard Specifications for Clay Sewer Pipe," serial designation C-13-57T or C-200-59T, the latter standard to be used for sewers laid at a depth of 12 feet or more.

(4) Cast iron soil and waste pipe stacks and branches shall conform to subsections H 62.15 (3) (b) or H 62.15 (5). Extra heavy pipe shall be used for stacks and branches receiving drainage from more than 5 stories of any building.

(5) Screw thread cast iron I.P.S. pipe and fittings shall conform to A.S.T.M. "Standard Specifications for Cast Iron Pressure Pipe," serial designation A-377-57.

(6) WROUGHT IRON PIPE (GENUINE). All wrought iron pipe shall be galvanized and shall conform to the A.S.T.M. "Standard Specifications for Welded Wrought Iron Pipe," serial designation A-72, latest revision.

(7) MILD STEEL PIPE. All mild steel, welded or seamless, shall be galvanized, and shall conform to the A.S.T.M. "Standard Specifications for Welded and Seamless Steel Pipe," serial designation A-53, latest revision.

(8) SCREW THREAD FITTINGS. Threaded fittings for vents, back vents, soil and waste pipes shall be of cast iron, galvanized malleable iron or brass. Waste fittings shall be of recessed, drainage pattern, and shall be galvanized or asphaltum coated. Drainage fittings shall have a minimum length from face to center as follows:

Pipe size, inches.....	1¼	1½	2	2½	3	4	5	6
Length, inches.....	2¼	2½	3¼	3¾	4¼	5¾	6½	7½

Note: Long turn Y branches or Y and 1/8 bend are recommended. See H 62.14 (10) and H 62.22 (38).

(9) LEAD MATERIALS. (a) Waste and vents. Lead waste and vent pipes shall be the best quality of drawn lead pipe, having a minimum weight per foot as follows:

Inside diameter, inches.....	1¼	1½	2	3	4
Weight per foot, pounds.....	2½	3¾	4¾	6	8

(b) *Traps.* All lead traps and bends shall have a minimum wall thickness of one-eighth inch.

(c) *Water supply piping.* Lead water supply piping should have minimum weights shown in the following table:

Inside diameter, inches	Weight lbs. per foot	Wall thickness inches	Classification	
			East	West
3/8	2		AA	XS
1/2	2		AA	XS
5/8	3		AA	XS
3/4	3 1/2	.231	AA	XS
1	4 3/4	.246	AA	XS
1 1/4	7 3/4	.320	AAA	XXS
1 1/2	11 1/4	.386	AAA	XXS
2	19 1/2	.504	AAA	XXS

(d) *Sheet lead.* Sheet lead shall weigh not less than 4 pounds per square foot.

(10) BRASS PIPE AND FITTINGS. (a) *Specifications.* All brass pipe used for soil, waste, vent and water pipes, except fixture traps and overflows, shall be of commercial standard pipe size and conform to A.S.T.M. "Standard Specifications for Brass Pipe," serial number B-43, latest revision.

(b) *Fittings for soil and waste pipes.* Brass screw thread fittings used for soil and waste pipes, shall be of the recessed, drainage fitting pattern.

(c) *Fittings for water pipe.* Fittings and couplings for brass water pipe shall be of unfinished red brass, with flat band, guaranteed for 175 pounds water-working pressure and shall conform to A.S.A. "American Standard Brass or Bronze Screwed Fittings," serial number B-16.15, latest revision. In erecting brass pipe, friction wrenches and friction vises shall be used exclusively except on pipe larger than 3 inches in diameter.

(d) *Brass tubing.* All brass tubing used for fixtures, traps and overflows between wall or floor and fixtures shall be made of seamless brass tube with a thickness of at least 0.0453 inch (No. 17 Brown & Sharp Gauge) and shall conform to A.S.T.M. "Standard Specifications for Seamless Brass Tubes," serial number B-135, latest revision.

(e) *Traps and overflows.* All brass fittings used for fixtures, traps and overflows shall be of a good quality of brass, free from sand holes, flaws or other defects, and of a uniform thickness equal to twice the thickness of the brass tubing. The thickness of the threaded ends shall be equal to the thickness of the fitting at the root of the thread.

(f) *Soldering nipples* shall be of heavy cast brass, or of brass pipe of weight, thickness and size conforming to standard pipe sizes. (SPS). When cast they shall be of full bore and of not less than the weights given in the following table:

Inside diameter	Weight
1 1/4 inch	0 lb. 6 oz.
1 1/2 inch	0 lb. 8 oz.
2 inch	0 lb. 14 oz.
2 1/2 inch	1 lb. 6 oz.
3 inch	2 lb. 6 oz.
4 inch	3 lb. 8 oz.

(g) *Weight of brass ferrules.* Brass ferrules shall be of a good quality of brass, composed of a mixture that will fuse readily with plumbers' solder, free from sand holes, flaws or other defects, uniform in thickness, and at least four and one-half inches long, of a size and weight as shown in the following table:

Inside diameter, inches	Weight
1½	1 lb. 1 oz.
2	1 lb. 4 oz.
3	1 lb. 14 oz.
4	2 lb. 8 oz.
5	3 lb. 0 oz.
6	3 lb. 8 oz.

(11) **COPPER TUBE AND FITTINGS.** (a) *Copper tube* used for water, soil, waste and vent piping shall conform to A.S.T.M. "Standard Specifications for Seamless Copper Water Tube," serial number B-88, latest revision. Copper water tube used for underground water lines shall be type "K," either soft or hard temper. Copper tube used for interior water lines shall have a wall thickness equal to or better than type "L" and shall be hard temper, except that concealed vertical tube may be of soft temper for repair and replacement lines only. Copper tube used for soil, waste and vent piping shall have a wall thickness equal to or better than type "M" and shall be of hard temper.

(b) *Fittings* used with copper water tube shall be of the sleeve type, of such size that the solder will completely fill the joints by capillary action. Cast red brass fittings shall conform to A.S.A. "American Standard Cast-Brass-Solder-Joint Fittings," serial number B-16.18, latest revision. Wrought copper fittings may be used for water piping only and shall have a wall thickness at least equal to that of the tube with which it is to be used. All waste fittings shall be cast red brass recessed drainage fittings and shall be soldered. Sleeve branches (saddle tees) will not be allowed. Fittings on water pipe may be soldered, flared or flanged provided that all above-ground tube which will be concealed shall be soldered. The solder used shall be 50-50 lead-tin (new metals) or tin-antimony containing 90 to 96% tin and 4 to 10% antimony.

(12) **SHEET COPPER OR BRASS.** All sheet copper or brass shall be of sufficient weight to serve the purpose for which it is used. Sheet used for local and interior ventilating pipe shall have a thickness of at least 0.0159 inch (No. 26, B. & S. gauge).

(13) **GALVANIZED SHEET IRON.** Galvanized sheet iron for local room vents shall be not lighter than the following B. & S. gauge:

No. 26 for 2 to 12 inch pipe.

No. 24 for 13 to 20 inch pipe.

No. 22 for 21 to 26 inch pipe.

(14) **ASBESTOS CEMENT PIPE AND FITTINGS.** Asbestos cement pipe and fittings and other equal piping materials with approved fittings and methods of jointing may be used for local vent pipes. See sub-sections H 62.14 (8) (b), H 63.02.

Note: The addresses of the organizations preparing standards referred to in this section are as follows:

A.S.A. (American Standards Association), 70 East 45th St., New York 17,

N. Y.; A.S.T.M. (American Society for Testing Materials), 1916 Race St., Philadelphia 3, Pa.; A.S.M.E. (American Society of Mechanical Engineers), 29 W. 39th St., New York, N. Y.

History: 1-2-56; am. (3), (4), and (5), Register, August, 1961, No. 68, eff. 9-1-61.

H 62.16 Joints and connections. (1) SEWER AND DRAIN PIPE JOINTS.

(a) *Vitrified pipe.* Joints in vitrified pipe shall be either hot poured joints, made with acceptable bituminous or plastic materials, or be pre-fabricated resilient materials bonded to the pipe at the producing plant.

1. Hot poured joint. Hot poured joint compounds shall be water resistant and shall meet requirements hereinafter set forth. A primer shall be applied to the inside face of the bell and outside face of the spigot at least 24 hours prior to installation and preferably by the manufacturer. Joint faces shall be clean. In joining vitrified clay pipe, or fittings, the spigots shall be carefully centered into the bells. Joints shall be firmly packed with unoled hemp, oakum or jute in such a manner as not to disturb alignment. The depth of the jointing compound shall be at least 75% of the hub-depth. Care shall be exercised in placing the running rope to insure non-leakage during pouring and it shall not be removed until the compound is set. The compound shall be poured continuously and as rapidly as possible until the joint is completely filled.

a. Joint-sealer compounds shall consist essentially of asphalt, coal-tar pitch or plastic soluble in CS₂ and inert mineral filler. The compounds shall be free from water, uniform in appearance and consistency, and shall not foam when heated to 350° F. Proportions of component materials of the compounds, expressed as percentages of total weight, shall be within the limits of the accompanying table. The physical properties of joint sealing compound also shall be as shown in said table. Material not definitely specified shall be of a good commercial quality entirely suitable for the purpose.

CHEMICAL COMPOSITION AND PHYSICAL PROPERTIES

	Asphalt Base	Coal Tar Pitch Base	Plastic Base
Asphalt (soluble in CS ₂).....	45-60		
Coal-tar pitch ¹		75-80	
Plastic ² (soluble in CS ₂).....			35-50
Inert mineral matter (determined as ash).....	40-55	20-25	50-65
Organic matter (insoluble in CS ₂), maximum.....	5		5
Specific gravity at 77° F.....	1.40-1.55	1.40-1.50	1.65-1.75
Ductility at 77° F. (cm.), minimum.....	1.5		
Softening point, °F.....	190-250	180-190	200-230
Penetration:			
At 77° F., 100 gm., 5 sec.....	5-15	0-2	0-1
At 115° F., 50 gm., 5 sec.....		5-10	0-3

¹The coal-tar pitch shall be produced from coke-oven tar by distillation or special processing.

²Acyelic polymeric hydrocarbon.

b. No chemical action shall occur when the joint sealer compounds are subjected to immersion for 5 days in each of the following solutions: 1 percent HCL, 1 percent HNO₃, 1 percent H₂SO₄, 5 percent KOH, and saturated H₂S.

c. The content of inert mineral filler, asphalt, plastic, and organic matter in the compound shall be determined in accordance with A.S.T.M. "Standard Method of Test for Bitumen," serial designation D 4-52.

d. The specific gravity of the compound shall be determined in accordance with A.S.T.M. "Standard Method of Test for Specific Gravity of Asphalts and Tar Pitches Sufficiently Solid To Be Handled In Fragments," serial designation D 71-52.

e. Ductility shall be determined in accordance with A.S.T.M. "Standard Method of Test for Ductility of Bituminous Materials," serial designation D 113-44.

f. The softening point of the compound shall be determined in accordance with A.S.T.M. "Standard Method of Test for Softening Point of Bituminous Materials," serial designation D 36 -26.

g. The penetration of the compound shall be determined in accordance with A.S.T.M. "Tentative Method of Test for Penetration of Bituminous Materials," serial designation D 5-59T.

h. Joint-sealing compounds shall not fail, either in bond or cohesion, under a bond stress of 75 p.s.i. when tested as follows: Three portland-cement briquets shall be made and cured for 7 days in accordance with A.S.T.M. "Standard Method of Test for Tensile Strength of Hydraulic Cement Mortars," serial designation C 190-59, except that the sand shall be concrete sand conforming to the requirements of A.S.T.M. "Standard Specifications for Concrete Aggregates," serial designation C 33-57. The briquets shall be cut smoothly in two parts transversely at the waist, oven dried at 220° F. for 2 hours and allowed to cool at room temperature for at least 2 hours. The two parts shall be placed in a suitable mold or form and a one-inch-square piece of vitrified clay with all glaze removed shall be placed between and approximately $\frac{3}{8}$ inch from the two parts of the briquet and so that the longitudinal axis will be approximately normal to the one-inch-square surfaces. Sealing compound, heated to a free-flowing temperature but not in excess of the pouring temperature indicated on the container, shall be poured into the mold between the cut surfaces of the briquet and the piece of vitrified clay as indicated in the accompanying figure and allowed to air cool at room temperature for at least 2 hours. If the manufacturer's directions for use of the compound as printed on the container require priming, the cut surfaces of the briquet and the vitrified clay shall be so primed with the recommended primer before pouring the compound. Any bituminous material which may have accumulated on the briquets or pieces of vitrified clay other than on the one-inch-square surfaces shall be removed with a knife.

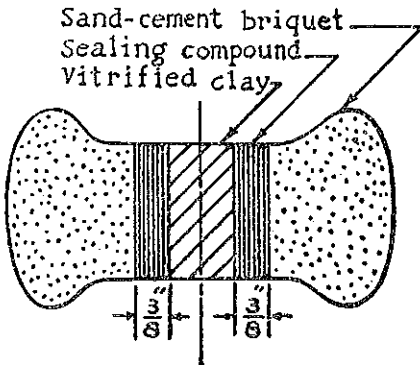

The bearing surfaces of the clips of the testing machine shall be clean and free from incrustations. The roller bearings shall be well oiled and in condition to ensure free turning. The stirrups supporting the clips shall be kept free from accumulations and the pivots shall be in proper adjustment so that the clips may swing freely on the pivots without binding in the stirrups. The test specimens shall be carefully centered in the clips. The load shall be applied continuously at a uniformly increasing rate of 600 ± 25 pounds per minute until the specimen fails in bond or in cohesion.

2. Pre-fabricated joints. Resilient jointing materials shall conform to the A.S.T.M. "Tentative Specifications for Vitrified Clay Pipe Joints Using Materials Having Resilient Properties," serial designation C-425-60T. Only virgin materials shall be used. The composition of the jointing material shall be periodically checked after fabrication by an accredited laboratory. Prior to making the installation, the joint material on both the bell and spigot ends shall be wiped clean and coated with a lubricant of an adhesive or welding type. The spigot end shall be inserted in the bell and pressure applied until the pipe is properly seated.

(b) *Concrete pipe.* Joints in concrete pipe shall be made with hot poured jointing compounds or rubber gaskets.

1. Hot poured joint. Hot poured joints shall conform to requirements of subsection H 62.16 (1) (a) 1.

2. Rubber gasket joint. Rubber gaskets shall consist of durable and resilient rubber formed into a shape which will be compressed within the annular space between two adjacent pipes to form a watertight joint. The rubber gasket shall conform to A.S.T.M. "Tentative Specifications for Watertight Rubber Type Gasket for Circular Concrete Sewer and Culvert Pipe," serial designation C-443-60T.

(c) *Asbestos-cement pipe.* Asbestos-cement pipe shall be jointed by ring type coupling consisting of a sleeve made of the same material as the pipe, a rubber center ring, and 2 rubber sealing rings. Rubber rings shall be of moulded resilient and durable rubber. The inside diameter of the sleeve shall have end bevelling and inside machining to provide a smooth surface. A groove for the center ring and 2 grooves for the sealing rings shall be machined in the sleeve. The end outside surfaces of the pipe shall be machined at the factory to proper dimensions to permit the pipe to enter the coupling after lubricant is applied to the pipe ends in a manner to cause the sealing rings to compress and slide to provide a proper seal.

(d) *Dissimilar pipe.* Underground joints between dissimilar materials shall be made with suitable adapters approved by the board.

Note: Standards of the American Society for Testing Materials (ASTM) are available for inspection at the office of the board of health, the secretary of state and the revisor of statutes, or may be procured for personal use from the American Society for Testing Materials, 1916 Race Street, Philadelphia 3, Pennsylvania. Commercial Standards of the U. S. Department of Commerce also are available for inspection at the office of the board of health, the secretary of state and the revisor of statutes, or may be procured for personal use from the Superintendent of Documents, U. S. Government Printing Office, Washington 25, D. C.

(3) **CAST IRON PIPE.** All joints in cast iron pipe and fittings shall be made by first inserting a roll of hemp, oakum or jute and thoroughly calking it in place, and then following with pure molten lead well calked, not less than one inch deep, lead to be brought to top of hub and faced. No paint, varnish or putty will be allowed on the joints until they have been tested.

(4) **GALVANIZED WROUGHT IRON AND STEEL PIPE.** Joints in galvanized iron pipe shall be standard screw joints, and all burrs or cuttings shall be removed. All screw joints shall be made with white or red lead, mineral paint, or other approved compounds, applied on outside thread. Not more than three threads of made-up joints shall be exposed, and they shall be protected by a coating of mineral or asphaltum paint or other approved compound, applied before the work is tested or inspected.

(5) **BRASS PIPE.** Joints on brass pipe shall conform to provisions of subsection (4) except that exposed threads require no coating.

(6) **COPPER TUBE.** All joints in copper water tube shall be made in a manner to insure a permanent water-tight joint. The joints shall be properly fluxed and made with approved solder. The joints shall be wiped clean to remove excess flux after the soldering operation has been completed. See subsection H 62.15 (11).

(7) **DISSIMILAR METALS.** Connections between wrought iron or brass and cast iron shall be either a calked joint or a screw thread joint. Connections between lead and cast or wrought iron pipes shall be made with a calked joint, a soldering nipple or threaded joint. Wrought iron pipe connections shall be made with a right and left coupling, flanged union with durable gasket, a ground faced union or a running thread with lock nut made tight with wicking and red or white lead. Joints in lead pipe or between lead, brass or copper pipes shall be wiped joints except solder brazed or sweated joints on reamed, concave brass bushings in connection with exposed brass or lead traps. See subsection H 62.22 (20).

(8) **WASTE PIPE.** (a) *Lead.* All lead under-floor waste pipes so far as practicable should be free from short bends. All branch joints in connection with water-carrying waste pipes should be of the sanitary "Y" pattern and all such joints should be so prepared and joined as to leave a clean interior, free from solder, obstructions or reductions of the respective pipe diameter. All lead waste pipes should be properly graded and substantially supported to guard against sagging or displacement and so installed that stoppages may be removed from any portion. To accomplish this, sink and basin traps should be so joined or connected to the waste pipes that they may be readily removed for wiring or rodding of the pipe throughout its entire length including waste branches thereof. Where lead closet bends are used, no water carrying waste pipe or branch shall be connected thereto. Where solder nipples are used in connecting to iron bends they should be straight bore of a size corresponding with the inside diameter of the waste pipe, but no such nipple should be less than 2 inches inside diameter. All lead bends should be so made as not to weaken the lead at the heel of the bend and all joints shall have a wall thickness of solder not less than three-sixteenths of an inch measured at the center of the pipe joint.

(b) *Screw thread.* All under-floor and concealed threaded waste pipes and fittings should be designed and constructed by the plumber to conform with the following minimum specifications: The waste piping for baths, sinks, basins and other similar fixtures shall be properly graded, free from short or unnecessary offsets, and all fittings shall be of the long radius sanitary pattern. Ends of all piping shall be cut straight and reamed on the inside. The thread should

be cut to the required length and depth and so made up that the end of the pipe extends to the recess receiving shoulder of the fitting. Where avoidable no 90 degree universal swing joints or any offset connection should be made. All changes in direction should be made by means of "Y"s or 5 $\frac{1}{8}$, 11 $\frac{1}{4}$, 22 $\frac{1}{2}$, 30, 45, 60, or 90 degree long radius pattern elbows. All ells and other fittings should be full bore and all such pipes and fittings should have a smooth interior.

(9) **ROOF TERMINALS, FLASHING.** The joint at the roof shall be made water tight by the use of copper, lead, galvanized sheet metal or iron plates or flashings. The flashing shall extend not less than 6 inches from the pipe. All flashings shall be substantially made and so placed as to insure a permanent tight joint. Roof flashings designed and constructed to provide an air space between the pipe and flashing to prevent freezing of soil and vent pipe terminals are recommended. See subsections H 62.15 (9) (d), (12), H 62.22 (18).

(10) **EARTHENWARE.** The connections between soil pipe and fixtures of earthenware, vitreous china or enameled iron shall be made by means of a brass floor plate, not less than three-sixteenths inch in thickness, soldered or wiped to lead pipe, or an iron floor flange connection calked to iron pipe, or an iron or brass connection calked or screwed to wrought iron or steel pipe, with the fixture floor flange bolted to the floor connection with solid brass closet bolts. Floor joints shall be made air-tight with an asbestos graphite ring, asbestos or rubber gasket, or washer, or metal to earthenware, or metal to metal union. A paste of red or white lead or other equal compound may be used.

(11) **OTHER TYPES.** Any type of joint other than those specified in this code which the board approves may be used.

(12) **PROHIBITED FITTINGS.** Sanitary tees of short radius shall not be used except in connecting horizontal to vertical soil or waste pipes in which the flow is toward the vertical line. The use of one-fourth bends or elbows in soil or waste pipes is governed by H 62.15 (5), (8), H 62.22 (37), and (38). One-fourth bends with side or heel outlets except when they are made with "Y" or sanitary "T" branches, and all double hub fittings, double tees and double sanitary tees when used horizontally are prohibited, except when smaller pipes discharge into a larger pipe. Double hubs and double hub fittings may be used on rain water leader and vent lines. Offsets having less than one-fifth pitch will not be permitted. The use of a drive ferrule is prohibited and the use of combination lead ferrules will be permitted only when the calk joint can be made in the upright position. All waste and vent pipes must enter soil pipe by means of properly inserted fittings. The drilling and tapping of soil, vent and waste pipes and house drains to receive waste and vent pipes of any description is strictly prohibited, and in no case will the use of saddles or bands be permitted. No double hub or inverted calk joint shall be permitted in soil and waste lines. Whenever wrought or galvanized iron pipe connects with cast iron, soil waste or vent lines, tapped fittings or tap extension pieces shall be used except where pipe and hub are the same diameter.

History: 1-2-56; r. and recr. (1) and (2), Register, August, 1961, No. 68, eff. 9-1-61.

H 62.17 Repairs and reconstruction. (1) DEFECTIVE PLUMBING. Whenever it shall appear upon inspection that any part of an existing plumbing system is defective, or fails to conform to the requirements of this code and by reason of such failure tends to create a nuisance, it shall be repaired, renovated, replaced or removed within 30 days, upon written notice from the state or local health officer.

(2) **FIXTURES REPLACED.** When an old or defective fixture is removed, to be replaced by a new one, and no other fixture or piping is to be added or remodeled, it will not be necessary to reconstruct the soil, waste or vent piping to make it conform to this code, unless the same is in a defective condition. In such cases, if found necessary, the fixtures shall be provided with efficient deep seal traps or deep seal resealing traps of the self-scouring centrifugal type.

(3) **RECONSTRUCTION.** When old or defective plumbing is to be remodeled, additional fixtures installed or the whole plumbing system moved to another part of the building the remodeled system shall be made to conform to this code.

(4) **OLD MATERIALS RE-USED.** All fixtures, soil, waste, and vent pipes removed from an old building, if found to be in good condition, may be used in the same building or may be used in another building, provided they are approved by the board or local plumbing inspector and the owner of the building in which they are installed gives his written consent.

(5) **OLD HOUSE DRAINS.** Old house drains may be used in connection with new buildings or new plumbing only when they are found on examination or test to conform to the requirements of this code governing new sewers and drains. If the old work is found defective, the local or state inspector shall notify the owner of the changes necessary to make it conform to the requirements of this code.

(6) **REPAIRS.** All repairs to fixtures or piping shall be done in a substantial, sanitary and workmanlike manner.

H 62.18 Water supply systems. (1) WATER SERVICE. (a) Size. The water service pipe to any building shall be of sufficient size to permit a continuous ample flow of water under maximum simultaneous use to all fixtures and points of service. The minimum diameter of the service pipe shall be five-eighths inch.

(b) **Materials.** The service pipe from a main or from the pump of a privately owned supply to any building shall be copper water tube, lead, brass, cast iron or galvanized steel or wrought iron pipe.

(c) **Valve controls.** Service controls shall include a valve or shut-off at the main, a curb stop or valve at the curb or privately owned pump, and a valve or stop inside the foundation wall of each building.

(2) **BUILDING DISTRIBUTION SYSTEM. (a) Size.** The water supply piping shall be three-fourths inch in diameter for iron or brass pipe. The diameter of any riser or branch serving more than one plumbing fixture or appliance shall not be less than three-fourths inch for iron or brass pipe. The diameters of branches to single fixtures shall not be less than one-half inch except that three-eighths inch pipe not to exceed 5 feet in length may be used to supply water closet tanks, lavatories or similar fixtures. If copper water tube is used

the minimum pipe diameters given above may be decreased one standard copper water tube size, except the minimum pipe diameter shall be three-eighths inch.

(b) *Materials.* All water supply pipes within a building shall be of lead, galvanized wrought iron or steel, brass, or cast iron, with brass or galvanized malleable iron fittings, or copper water tube and fittings. No pipe or fittings that have been used for other purposes shall be used for distributing water for drinking or domestic supply purposes. See section H 62.16.

(c) *Supports.* All piping shall be supported to prevent undue strains upon connections or fixtures, and shall be so aligned and graded that the entire system or parts thereof can be controlled and drained. The formation of traps or sags in water piping shall be avoided where possible. When unavoidable such sags, traps or inverts shall have provisions for properly draining same.

(d) *Valve controls.* Controls within a building shall include a valve or compression stop for each lawn sprinkler, hot water tank, water closet, urinal and point of entrance of the water service. In a multiple dwelling or public building a valve shall also be provided at the base of each riser and for each dwelling unit or public toilet room unless served by an independent riser, and for each branch serving fixtures in the basement.

(e) *Water supply to fixtures.* All plumbing fixtures shall be provided with a sufficient supply of water for flushing to keep them in a sanitary condition. Every water closet shall be flushed by means of an approved tank or flush valve, of at least 4-gallon flushing capacity and at least one gallon for each urinal. The water from flush tanks shall be used for no other purpose than to reseal drain traps. See subsections H 62.12 (8), (9).

(f) *Water hammer suppressors.* 1. Water hammer suppressors. All water supply systems, water distribution systems and components connected thereto, shall be provided with approved shock absorbing devices, located and sized to suppress water hammer.

2. Air chamber. Water supply risers of three or more floors shall terminate with an air chamber. Water supply pipes serving fixtures, appliances, equipment, devices and appurtenances shall terminate with an air chamber. For three-eighth and one-half inch inside diameter pipe the air chamber shall be $\frac{1}{2}$ inch x 1 inch x 14 inches. For three-quarter inch inside diameter pipe the air chamber shall be $\frac{1}{2}$ inch x $1\frac{1}{2}$ inches x 18 inches. For pipe sizes greater than three-quarter inch inside diameter the volume, length and diameter of the air chamber shall be in accord with the hydraulic design of the piping system served and the connection shall be one nominal inside diameter smaller than the pipe served. Excessively high air chambers should not be used. For the purpose of this rule, the length of an air chamber will be determined by measuring from the bottom of the restriction to the top of the air chamber with the length of the restricted portion no greater than $1\frac{1}{2}$ inches.

3. Mechanical suppressor. Approved mechanical water hammer suppressors may be installed in lieu of air chambers. The size and location of the suppressor shall be in accord with the hydraulic design of the piping system served. All mechanical water hammer suppressors shall be accessible.

(g) *Relief valves.* Relief valves shall be provided on all domestic hot water boilers or storage tanks of the closed type. No valve of any type shall be placed between the relief valve and a hot water boiler. The relief valve shall be installed at or within 18 inches of a boiler or hot water tank. The discharge pipe from the relief valve shall terminate in an open fixture or not more than 10 inches from the floor as close as possible to a drain properly connected to the house drain or house sewer. No thread shall be permitted at the end of such discharge pipe. The valve shall be an effective relief valve with non-corrosive seat and be of the diaphragm or bellows type which has been certified by a recognized testing laboratory or approved by the board. Relief valves should be provided on all private water systems using displacement type pumping equipment.

(h) *Protection against frost.* All water pipe, storage tanks and flushing tanks subject to low temperatures shall be effectively protected against freezing.

(3) **SPECIAL EQUIPMENT.** (a) *Separate piping for each source.* A water supply that meets accepted standards of purity for human consumption shall be distributed through a piping system entirely independent of any piping system conveying another water supply.

(b) *Piping by plumber.* In municipalities having public water supply and sewerage systems or in any area platted under ch. 236 adjacent to such municipalities and in metropolitan sewerage districts, no person not licensed by the board as a master plumber or as a journeyman plumber shall install any piping for water supply to any system designed for steam power, heating, temperature regulation, automatic fire protection, hydraulic power, or for any special water usage for industrial or manufacturing purposes. All such piping for supplying water for any system for steam power, heating, temperature regulations, automatic fire protection, hydraulic power, or for any special water usage for industrial or manufacturing purposes, shall be installed by the licensed plumber to the appliance forming the unit or initial point of such system and shall terminate with a valve, located at the unit or appliance to be connected.

(c) *Piping by equipment installer.* The connection of appliances forming the initial unit of such systems, to the water supply pipe installed by the licensed plumber, as prescribed by rules and regulations, may be made by the person installing such aforesaid systems, but the connection of the water supply shall be made in a manner to prevent the possibility of contamination of the water supply by the backflow of water from such systems by siphonage, drainage, or force.

(4) **PRIVATE SYSTEMS.** (a) *Source.* All private water supplies shall be uncontaminated and the source shall conform in construction with the specifications of the Wisconsin well construction and pump installation code. All supplies known to be subject to occasional pollution shall be either discontinued or made safe as directed by the board.

(b) *Capacity.* All private water supply systems, pumps, and water pressure storage tanks serving residences or public school and similar buildings shall be of sufficient capacity and size, and shall have

sufficient pressure and volume of water to provide adequate flushing facilities in order to maintain the plumbing fixtures and appliances in a sanitary and good operating condition at all times.

Note: For detailed information and specific rules and regulations governing the location, construction of wells, setting of pumps, sealing of well top, see the Wisconsin well construction and pump installation code adopted by the board pursuant to ch. 162, Wis. Stats.

History: 1-2-56; r. and recr. (2) (f), Register, October, 1968, No. 154, eff. 11-1-68.

H 62.19 Back siphonage and cross connections. (1) **PROHIBITED FIXTURE INSTALLATIONS.** No closet bowl or other fixture equipped with a flushometer valve shall be installed with a side or rear spud located below the lower part of the flush rim of the bowl.

(2) **PROHIBITED COMBINATION FAUCET USE.** No faucet or combination faucet or like appliance so installed as to form a cross connection directly or indirectly between a safe drinking water and an unsafe or questionable water supply shall be permitted.

(3) **PROHIBITED WATER—DRAINAGE SYSTEM INTERCONNECTION.** No direct plumbing fixture or pipe connection shall be made between any part of the water supply system and any part of the plumbing drainage system or impure water supply system unless adequately protected against back-siphonage.

(4) **PROTECTION FROM BACK-SIPHONAGE.** (a) *Fixture inlets.* All fixture water supply inlets of every description shall be located and designed so as to prevent the possibility of back-siphonage or back-drainage of any of the fixture contents into the water supply lines.

(b) *Inlet elevation.* Whenever possible the water supply inlet shall terminate at least two pipe diameters but not less than one inch above the maximum possible water level of the fixture, tank or vat so as to prevent the possibility of back-siphonage.

(c) *Vacuum-breaker.* If the water supply inlet cannot be raised above the maximum possible water level, an approved type of vacuum-breaker shall be installed between the control valve and the fixture in such manner that no back-siphonage is possible under any degree of vacuum in the water lines and with water in the fixture at the maximum possible water level. For positive protection each such fixture shall have a vacuum-breaker installed 4 inches above the maximum water level.

(d) *Maximum water level.* The maximum possible water level referred to heretofore shall be construed as the height to which water can rise in a fixture, tank or vat before it flows freely into the open atmosphere above the fixture rim or through adequate size openings so designed as not to be obstructed by debris or waste matter.

(e) *Impure liquids.* Fixture contents against which back-siphonage protection shall be maintained include all polluttional material, sewage, waste water, processing liquids, chemicals, and all water and other liquids which can be polluted at some time or other.

(5) **SPECIAL EQUIPMENT PROTECTION.** All water supply equipment and appliances serving special fixtures shall conform with the intent and purposes of this section. Any unusual use for water, as for air-conditioning equipment, hydraulic elevators, presses, fountains, etc., shall be given special consideration in relation to possible pollution of the pure water supply system.

(6) **IMPROPER LOCATION OF SEWERS AND DRAINS.** Sewers and drains shall never pass directly over water tanks or any place where drinking water, ice, or food is prepared, handled, or stored.

(7) **DUAL WATER SUPPLIES.** The maintenance of a pressure system of water supply whose purity is questionable, such as cistern water, in the same building in which a pure water supply exists is discouraged, especially if the water is piped throughout the building and not confined to a certain section for special uses or processing. The piping containing such impure water supply shall be painted red and properly labeled at intervals. Under no circumstances shall the two supplies be cross-connected or provision made for their cross-connection. No cross-connection shall be made between piping connected to a public water supply system and piping of a private water supply system. See H 62.22 (40).

H 62.20 Private domestic sewage treatment and disposal systems.

(1) **APPROVALS AND LIMITATIONS.** (a) *Allowable use.* Septic tank and effluent absorption systems or other treatment tank and effluent disposal systems as may be approved by the department may be constructed when no public sewerage system is available to the property to be served or likely to become available within a reasonable time. All domestic wastes shall enter the septic or treatment tank unless otherwise specifically exempted by the department or this section.

(b) *Public sewer connection.* Private domestic sewage treatment and disposal systems shall be discontinued when public sewers become available to the building served. The building sewer shall be disconnected from the private system and be connected to the public sewer. All abandoned septic tanks and seepage pits shall have the contents removed and shall be immediately filled with sand, gravel or similar material.

(c) *Plans and specifications.* 1. Public buildings. Complete plans and specifications shall be submitted to the department and written approval received before letting contracts or commencing work for all private domestic sewage treatment and disposal systems, and for the addition to or replacement of existing systems for all public buildings. Included as public buildings but not limited by enumeration herewith are:

- a. Theaters and assembly halls
- b. Schools and other places of instruction
- c. Apartment buildings, hotels and places of detention
- d. Factories, office and mercantile buildings
- e. Mobile home parks, camp grounds and camping resorts
- f. Parks

2. Local approval. The approval by county or other local governmental agency shall not exempt the requirements for state approval for the installation of sewage treatment and disposal systems serving public buildings.

3. Submission of plans and specifications. All plans and specifications shall be submitted in triplicate and shall include the following:

a. Detailed plan of the proposed septic tank or treatment tank and effluent disposal system showing building location with all lateral distances indicated, including distance from building served to system, from system to well, lot line, lake, stream or other watercourse.

b. Legal description of the property on which the system is to be installed.

c. Soil boring and percolation test data.

d. Ground slope and lot size.

e. Complete data relative to the expected use and occupancy of the building to be served.

4. Availability of plans. There shall be maintained at the project site one set of plans bearing the department's stamp of approval.

(d) *Specific limitations.* 1. Cesspools. Cesspools are prohibited.

2. Revised plans. Approved plans and specifications shall not be revised except with the written approval of the department.

3. Industrial wastes. When industrial wastes are intended to be disposed of by soil absorption, the department shall be consulted as to requirements.

4. Clear water. The discharge of surface, rain and other clear water into a private domestic sewage disposal system is prohibited.

(2) **SOIL TESTS AND SITE REQUIREMENTS.** (a) *Soil tests supervision.* Soil boring and percolation tests shall be made by or under the direction and control of a master plumber, or master plumber restricted licensed in Wisconsin to install private sewage disposal systems or an engineer, architect, surveyor or sanitarian registered in Wisconsin. Certification of the tests shall be signed by the person providing supervision and control on blank forms furnished by the department.

(b) *Percolation and boring tests.* The size and design of each proposed soil absorption system shall be determined from the results of soil percolation tests and soil borings conducted in accordance with this section. At least 3 percolation tests shall be conducted with the holes located uniformly over the area and to the depth of the proposed absorption system. At least 3 soil borings shall be dug to a depth at least 3 feet below the bottom of the proposed system. The borings shall be distributed uniformly in the area of the proposed system.

(c) *Septic tank location.* No tank shall be located within 5 feet of any building or its appendage, 2 feet of any lot line, 10 feet of any cistern, 25 feet from any well, reservoir, swimming pool or the high water mark of any lake, stream, pond or flowage. Where practicable, greater distances should be maintained.

(d) *Soil absorption site.* 1. Location. All soil absorption disposal systems should be located at a point lower than the surface grade of any nearby water well. The soil absorption system shall be located not less than 25 feet from any building, dwelling or cistern, 50 feet from any water well, reservoir or swimming pool, 5 feet of any lot line, 25 feet of any water service or 50 feet of the high water mark of any lake, stream or other watercourse. Where possible, greater distances should be maintained.

2. Percolation rate—trench or bed. A subsurface soil absorption system of the trench or bed type shall not be installed where the average percolation rate of the 3 tests for the site is slower than 60 minutes for water to fall one inch.

3. Percolation rate—seepage pit. For a seepage pit, percolation tests shall be made in each vertical stratum penetrated below the inlet pipe. Soil strata in which the percolation rates are slower than 30 minutes per inch shall not be included in computing the absorption

area. The average of the results shall be used to determine the absorption area.

4. Flood plain. A soil absorption system shall not be installed in a flood plain.

5. Slope. The soil absorption system shall be constructed on that portion of the lot which does not exceed the slope here specified for the class. In addition, the soil absorption system shall be located at least 20 feet from the top of the slope.

Minutes Required for Water to
Fall One Inch

Class	Shallow Absorption Systems	Deep Absorption Systems	Slope
1-----	Under 3	Under 2	20%
2-----	3 to 45	2 to 30	15%
3-----	45 to 60	30 to 60	10%

6. Filled area. A soil absorption system shall not be installed in a filled area unless written approval is received from the department.

7. Ground water and bedrock. There shall be at least 3 feet of soil between the bottom of the soil absorption system and high ground water or bedrock.

(3) PERCOLATION TEST PROCEDURE. (a) *Type of hole.* The hole shall be dug or bored. It shall have vertical sides and have a horizontal dimension of 4 to 12 inches.

(b) *Preparation of hole.* The bottom and sides of the hole shall be carefully scratched with a sharp pointed instrument to expose the natural soil interface. All loose material shall be removed from the bottom of the hole which shall then be covered with 2 inches of coarse sand or gravel when necessary to prevent scouring.

(c) *Test procedure, sandy soils.* For tests in sandy soils containing little or no clay, the hole shall be carefully filled with clear water to a minimum depth of 12 inches over the gravel and the time for this amount of water to seep away shall be determined. The procedure shall be repeated and if the water from the second filling of the hole at least 12 inches above the gravel seeps away in 10 minutes or less, the test may proceed immediately as follows: Water shall be added to a point not more than 6 inches above the gravel. Thereupon, from a fixed reference point, water levels shall be measured at 10-minute intervals for a period of one hour. If 6 inches of water seeps away in less than 10 minutes, a shorter interval between measurements shall be used, but in no case shall the water depth exceed 6 inches. The final water level drop shall be used to calculate the percolation rate. Soils not meeting the above requirements shall be tested as in subsection (d) below.

(d) *Test procedure, other soils.* The hole shall be carefully filled with clear water and a minimum water depth of 12 inches shall be maintained above the gravel for a 4-hour period by refilling whenever necessary or by use of an automatic siphon. Water remaining in the hole after 4 hours shall not be removed. The soil shall be allowed to swell not less than 16 hours or more than 30 hours. Immediately following the soil swelling period, the percolation rate meas-

urements shall be made as follows: Any soil which has sloughed into the hole shall be removed and water shall be adjusted to 6 inches over the gravel. Thereupon, from a fixed reference point, the water level shall be measured at 30-minute intervals for a period of 4 hours unless 2 successive water level drops do not vary by more than $\frac{1}{8}$ of an inch. The hole shall be filled with clear water to a point not more than 6 inches above the gravel whenever it becomes nearly empty. Adjustment of the water level shall not be made during the last 3 measurement periods except to the limits of the last measured water level drop. When the first 6 inches of water seeps away in less than 30 minutes, the time interval between measurements shall be 10 minutes and the test run for one hour. The water depth shall not exceed 6 inches at any time during the measurement period. The drop that occurs during the final measurement period shall be used in calculating the percolation rate.

(e) *Verification.* 1. Physical characteristics. Depth to high ground water and bedrock, ground slope and percolation test results shall be subject to verification by the department. Verification of high ground water shall include, but not be limited to, a morphological study of soil conditions with particular reference to soil color and sequence of horizons.

2. Filling. Where the natural soil condition has been altered by filling or other attempts to improve wet areas, verification may require observation of high ground water levels under saturated soil conditions.

Note: Detailed soil maps are of value for determining estimated percolation rates and other soil characteristics.

(4) TREATMENT TANKS. (a) *Design.* 1. General requirements.

a. Septic tanks shall be fabricated or constructed of welded steel, monolithic concrete or other materials approved by the department. All tanks shall be watertight and fabricated so as to constitute an individual structure.

b. The design of prefabricated septic tanks shall be approved by the department.

c. Plans for site-constructed concrete tanks shall be approved by the department prior to construction.

d. The liquid depth shall not be less than 3 feet nor more than an average of 6 feet. The total depth shall be at least 8 inches greater than the liquid depth.

e. Rectangular tanks shall have a minimum width of 36 inches and shall be constructed with the longest dimensions parallel to the direction of flow.

f. Cylindrical tanks shall have an inside diameter of not less than 48 inches.

g. Each prefabricated tank shall be clearly marked to show liquid capacity and the name and address or registered trademark of the manufacturer. The markings shall be inscribed into or embossed on the outside wall of the tank immediately above the outlet opening. Each site-constructed concrete tank shall be clearly marked at the outlet opening to show the liquid capacity. The marking shall be inscribed into or embossed on the outside wall of the tank immediately above the outlet opening.

h. Precast concrete tanks shall have a minimum wall thickness of 2 inches.

2. Materials and joints. a. The concrete used in constructing a pre-cast or site-constructed tank shall be a mix to withstand a compressive load of at least 3,000 pounds per square inch. All concrete tanks shall be designed to withstand the pressures to which they are subjected.

b. The floor and sidewalls of site-constructed concrete tanks shall be monolithic except a construction joint will be permitted in the lower 12 inches of the sidewall of the tank. The construction joint shall have a key way in the lower section of the joint. The width of the key way shall be approximately 30% of the thickness of the sidewall with a depth equal to the width. A continuous water stop or baffle at least 6 inches in width shall be set vertically in the joint, embedded one-half its width in the concrete below the joint with the remaining width in the concrete above the joint. The water stop or baffle shall be copper, neoprene, rubber or polyvinylchloride designed for this specific purpose.

c. Joints between the septic tank and its cover and between the septic tank cover and manhole riser shall be tongue and groove or shiplap type and sealed watertight using neat cement, cement or bituminous compound.

d. Steel tanks shall be fabricated of new, hot rolled commercial steel. The tanks, including cover with rim, inlet and outlet collars and manhole extension collars shall be fabricated with welded joints in such manner as to provide structural stability and watertightness. Steel tanks shall be coated, inside and outside, in compliance with the U. S. Department of Commerce Commercial Standard 177.

Note: Commercial standard CS 177-62 of the U. S. Department of Commerce is available for inspection at the office of the department of Health and Social Services, the Secretary of State and the Revisor of Statutes, or may be procured for personal use from the Superintendent of Documents, U. S. Government Printing Office, Washington 25, D. C.

Any damage to the bituminous coating shall be repaired by recoating prior to installation of the tank. The gauge of the steel shall be as follows:

Septic Tank Capacity	Tank Component	Gauge of Steel
500 to 1,000 gallons-----	Bottom and sidewalls-----	14
	Cover-----	12
	Baffles-----	12
1,000 to 2,000 gallons-----	Complete tank-----	10
2,000 or more gallons-----	Complete tank-----	7

3. Tank accessories. a. The inlet and outlet openings shall contain a "boss," stop or other provision which will prevent the insertion of the sewer piping beyond the inside wall of the tank.

b. The inlet and outlet on all tanks or tank compartments shall be provided with open-end coated iron sanitary tees or baffles made of approved materials, so constructed as to distribute flow and retain scum in the tank or compartments. The tees or baffles shall extend at least 6 inches above and 9 inches below the liquid level, but not to exceed $\frac{1}{2}$ the liquid depth. At least 2 inches of clear space shall be provided over the top of the baffles or tees. The bottom of the outlet opening shall be at least 2 inches lower than the bottom of the inlet.

c. Each single compartment tank and each unit of a multicompart-ment tank shall be provided with at least one manhole opening no less than 24 inches square or 24 inches in diameter. Manholes shall terminate no more than 6 inches below the ground surface and be provided with a substantial, fitted, watertight concrete, steel or cast iron cover. Steel tanks shall have a collar for the manhole extensions permanently welded to the tank. The collar shall have a minimum height of 2 inches.

d. An airtight inspection opening shall be provided over the inlet baffle of all septic tanks which may be either a manhole or a cast iron pipe at least 4 inches in diameter. The upper end of the inspection pipe or manhole shall terminate not more than 6 inches below the ground surface.

(b) *Capacity and sizing.* 1. Minimum capacity. The capacity of a septic tank shall be based on the number of persons using the building to be served or upon the volume and type of waste. The minimum liquid capacity shall be 500 gallons.

2. Multiple tanks. When increased capacity is to be provided by a multiple number of tanks, the capacity of any tank shall be a minimum of 500 gallons. When 2 or more tanks are installed, approval of the design of the system shall be obtained from the department. The installation of more than 4 tanks in series is prohibited. Installation of septic tanks in parallel is prohibited.

3. Sizing of tank. a. The minimum liquid capacity for one and two family residences shall be as established in the following table:

Septic Tank Capacity One and Two Family Residences

Number of Bedrooms	Normal Plumbing	With Food Waste Grinder,
	Fixtures	Automatic Washer, Dishwasher Singly or in Combination
2 or less.....	500	750
3.....	650	975
4.....	800	1200
5.....	950	1375
6.....	1100	1650
7.....	1250	1875
8.....	1400	2200

b. For buildings other than one and 2 family residences the liquid capacity shall be increased above the 500-gallon minimum as established in the following table. For buildings having kitchen and/or laundry waste, the tank capacity shall be increased to receive the anticipated volume for a 24-hour period from the kitchen and/or laundry.

Apartment buildings (per bedroom).....	150	gals.
Assembly hall (per person—no kitchen).....	2	“
Bars and cocktail lounges (per patron space).....	9	“
Bowling alley (per alley).....	125	“
Bowling alley with bar (per alley).....	225	“
Camp grounds and camping resort (per camp space).....	100	“
Camps, day use only—no meals served (per person).....	15	“
Camps, day and night (per person).....	40	“
Car wash—subject to state approval		

Churches—no kitchen (per person).....	3	“
Churches—with kitchen (per person).....	7.5	“
Country clubs—subject to state approval		
Dance halls (10 sq. ft. per person).....	3	“
Dining hall—kitchen and toilet waste (per meal served).....	10	“
Dining hall—kitchen waste only (per meal served).....	3	“
Drive-in restaurants (per car space).....	30	“
Drive-in theaters (per car space).....	5	“
Factories and offices, (per employee—total all shifts—exclusive of industrial wastes).....	20	“
Hospitals (per bed space).....	200	“
Hotels or motels and tourist rooming houses (per room 2 persons per room).....	100	“
Migrant labor camp, central bath house (per employee).....	30	“
Mobile home parks, homes with bathroom groups (per site)....	200	“
Nursing and rest homes (per bed space).....	100	“
Parks, toilet wastes (per person—75 persons per acre).....	5	“
Parks, with showers and toilet wastes (per person—75 persons per acre).....	10	“
Restaurant—kitchen and toilet wastes (per seating space)....	30	“
Retail store (per employee).....	20	“
Retail store—customers (10 sq. ft. per person).....	1.5	“
Schools (per classroom).....	450	“
Schools with meals served (per classroom).....	600	“
Schools with meals served and showers provided (per classroom)...	750	“
Self-service laundries (per machine, toilet wastes only).....	50	“
Service stations (per car).....	10	“
Swimming pool bath houses (per person).....	10	“

(c) *Installation.* 1. Location. Tanks shall not be installed within the interior foundation walls of a building nor shall a new building or addition to an existing building be constructed or located over, or within 5 feet of a tank.

2. Bedding. A 3-inch thick tamped bedding shall be provided for all septic tank installations. The bedding material shall be sand, gravel, granite, limerock or other noncorrosive materials of such size that 100% will pass a ½-inch screen.

3. Backfill. a. The backfill material for steel tanks shall be as specified for bedding and shall be tamped into place, care being taken to prevent damage to the coating.

b. The backfill for concrete tanks shall be soil material, 100% of which shall pass a 2-inch screen and shall be tamped into place.

4. Piping. The inlet and outlet piping between a septic or other sewage tank and the firm ground beyond the excavation made to install the tank shall be cast iron pipe or other pipe approved by the department for the specific purpose. The joints between pipe and tank openings shall be made with lead and oakum.

5. Manhole riser joints. a. All joints on steel risers shall be welded or flanged and bolted and be watertight. All manhole extensions shall be bituminous coated inside and outside.

b. All joints on concrete risers and manhole covers shall be tongue and groove or shiplap type and sealed watertight using neat cement, cement or bituminous compound.

(5) SOIL ABSORPTION SYSTEM. (a) *Disposal of tank effluent.* The effluent from septic tanks shall be disposed of by soil absorption systems or by such other manner approved by the department.

(b) *Sizing—residential.* The area required for a soil absorption system serving residential property shall be determined from the following table using soil percolation test data:

Percolation Rate Minutes Required for Water to Fall One Inch	Minimum Absorption Area in Square Feet Per Bedroom			
	Normal Plumbing Fixtures	With Garbage Grinder	With Automatic Washer	With Both Grinder and Automatic Washer
Less than 3.....	50	65	75	85
3 to 10.....	100	120	135	165
10 to 30.....	150	180	205	250
30 to 45.....	180	215	245	300
45 to 60.....	200	240	275	330

(c) *Sizing—Other.* The required area for a soil absorption system serving installations other than residential property shall equal the absorption area specified for normal plumbing fixtures according to the percolation test results multiplied by the applicable unit specified in column 2, multiplied by the applicable factor in column 3 of the following table:

Column 1 Building Classification	Column 2 Units	Column 3 Factor
Apartment buildings.....	1 per bedroom.....	1.0
Assembly hall—no kitchen.....	1 per person.....	0.02
Bar and cocktail lounge.....	1 per patron space.....	0.2
Bowling alley.....	1 per bowling lane.....	2.5
Bowling alley with bar.....	1 per bowling lane.....	4.5
Camps, day use only.....	1 per person.....	0.2
Camps, day and night.....	1 per person.....	0.45
Camp ground and camping resort.....	1 per camping space.....	0.9
Church—no kitchen.....	1 per person.....	0.04
Church—with kitchen.....	1 per person.....	0.09
Dance hall.....	1 per person.....	0.06
Dining hall—kitchen and toilet.....	1 per meal served.....	0.2
Dining hall—kitchen only.....	1 per meal served.....	0.1
Drive-in restaurant.....	1 per car space.....	0.6
Drive-in theater.....	1 per car space.....	0.1
Factories, office buildings, exclusive of industrial waste.....	1 per person.....	0.4
Hotels or motels and tourist rooming houses.....	1 per room.....	0.9
Hospital.....	1 per bed space.....	2.0
Migrant labor camp—central bath house.....	1 per employee.....	0.25
Mobile home park.....	1 per mobile home site.....	2.0
Nursing and rest homes.....	1 per bed space.....	1.0
Parks—toilet waste only.....	1 per acre.....	4.0
Parks—showers and toilets.....	1 per acre.....	8.0
Restaurant—kitchen and toilet.....	1 per seating space.....	0.6
Retail store.....	1 per employee.....	0.4
Retail store.....	1 per customer.....	0.03
Self-service laundry—toilet wastes only.....	1 per machine.....	1.0
Service station.....	1 per car served.....	0.15
Swimming pool bath house.....	1 per person.....	0.2
School—no meals, no showers.....	1 per classroom.....	5.0
School—meals served or showers.....	1 per classroom.....	6.7
School—meals and showers.....	1 per classroom.....	8.0

(d) *Installation.* 1. Shallow system. a. A seepage trench or a seepage bed having a depth of 36 inches or less below final grade shall be termed a shallow absorption system.

b. The bottom of the seepage trench shall be level. Seepage trench excavations shall be from 1 to 3 feet in width. The absorption area of a seepage trench shall be computed by using the bottom area only. Trench excavations shall be spaced at least 10 feet apart. The individual laterals preferably should not be over 100 feet long.

c. Seepage beds shall meet the requirements of a seepage trench except that the excavation is more than 3 feet wide and has more than one distribution line. Distribution lines in a seepage bed shall be uniformly spaced no more than 6 feet apart and no less than 3 feet apart and no more than 3 feet from the sidewall.

d. Seepage trenches or beds shall not be excavated when the soil is excessively wet.

e. All smeared or compacted surfaces in the seepage trench or bed shall be scarified to the depth of the compaction and the loose material removed.

f. Distribution piping shall be perforated clay tile, bituminous fiber or cement asbestos or short lengths of clay or concrete drain pipe. In seepage trenches or beds the bottom of the distribution piping shall be laid 12 to 24 inches below the surface in continuous straight or curved lines. A slope of 2 to 4 inches per 100 feet shall be maintained. Drain pipe shall be spaced approximately $\frac{1}{4}$ inch apart and blinded at the top with tar paper.

g. Fresh air inlets of cast iron pipe shall be provided and be placed so as to assure a free flow of air throughout the entire installation. The vent pipes shall be at least 4 inches in diameter and extend at least 12 inches above the ground surface and terminate with an approved vent cap. Fresh air inlets shall be located at least 25 feet from any window, door or air intake of any building used for human habitation. A maximum of 4 distribution lines may be served by one common 4-inch vent when interconnected by a common header pipe.

h. A minimum of 12 inches of clean, graded rock or similar aggregate ranging in size from 1 to 2½ inches shall be laid into the trench or bed below the distribution pipe and such aggregate shall extend at least 2 inches over the top of the distribution pipe. The aggregate shall be covered with untreated building paper or 2 inches of marsh hay or equal. The first 4 to 6 inches of soil backfill shall be hand tamped.

i. Where the total lineal feet of drain pipe in a seepage trench or bed exceeds 1,000 feet, discharge of septic tank effluent into the absorption system should preferably be regulated by an automatic siphon. The dosing tank in which the siphon is situated shall have a capacity equal to 75% of the combined volume of the distribution lines in the absorption system.

2. Deep system. a. A seepage trench, seepage bed or a seepage pit developed to a depth of more than 36 inches below the final grade shall be termed a deep absorption system.

b. The bottom of the distribution line shall be laid 12 to 48 inches below the surface in continuous straight or curved lines. Slope, spacing and venting shall be equal to section H 62.20 (5) (d) 1.

c. Credit may be given for the added absorption area provided for the depth that exceeds 12 inches of aggregate below the distribution line. Such credit shall be in accord with the following table which establishes the percentage of length of a standard absorption trench. The standard absorption trench is one which the aggregate material extends 12 inches below the distribution pipe.

Percent of Length of Standard Trench

Depth of Aggregate Below Distribution Line	Percent of Length of Standard Trench			
	Trench Width 12"	Trench Width 18"	Trench Width 24"	Trench Width 36"
12	100	100	100	100
18	75	78	80	83
24	60	64	66	71
30	50	54	57	62
36	43	47	50	55
42	37	41	44	50
48	33	37	40	45

d. The area of a seepage bed having aggregate to a depth that exceeds 12 inches below the distribution pipe may be computed as follows:

$$\text{Percent of standard bed area} = \frac{w + 2}{w + 1 + 2d} \times 100$$

w = width of bed in feet

d = depth of aggregate below distribution pipe in feet minus 6 inches

e. A seepage pit shall have a minimum inside diameter of 5 feet and shall consist of a chamber walled up with material such as a perforated precast concrete ring, concrete block, brick or other material approved by the department which allows effluent to percolate into the surrounding soil. Seepage pits shall be located 10 feet or more apart. The pit bottom shall be left open to the soil. Crushed rock or similar aggregate 1 to 2½ inches in size shall be placed into a 6-inch minimum annular space separating the outside wall of the chamber and sidewall excavation. Depth of the annular space shall be measured from the inlet pipe to the bottom of the walled-up chamber. Each seepage pit shall be provided with a 24-inch manhole extending within 6 inches of the ground surface and a 4-inch fresh air inlet which shall meet the requirements of sections H 62.20 (4) (a) and H 62.20 (5) (d). Excavation and scarifying shall be in accord with section H 62.20 (5) (d). The effective area of a seepage pit shall be the vertical wall area of the walled-up chamber for the depth below the inlet for all strata for which the percolation rates are lower than 30 minutes per inch. Six inches of annular opening outside the vertical wall area may be included for determination of effective area. The following table may be used for determining the effective sidewall area of circular seepage pits:

Effective Absorption Area Seepage Pit*

Inside Diameter of Walled Up Chamber in Feet*	Depth Below Inlet					
	3	4	5	6	7	8
7.....	75	101	126	151	176	201
8.....	85	113	142	170	198	226
9.....	94	126	157	188	220	251
10.....	104	138	173	208	242	277
12.....	123	163	204	245	286	327

*The 6 inch annular opening credit is included.

(6) MAINTENANCE AND SLUDGE DISPOSAL. (a) *Maintenance.* Septic tanks shall be cleaned whenever the sludge and scum occupies ¼ of

the tank volume. All sludge, scum, liquid and any other material removed from a private domestic sewage treatment and disposal system is hereafter referred to as sludge.

(b) *Sludge disposal.* Sludge shall be disposed of as follows:

1. Public sewer. By discharge into a public sewerage system when practical. The point and method of discharge into the system shall be subject to the requirements of the municipality.

2. Approved site. By discharge at a disposal site designated by the local governmental authority.

3. Other. In the absence of a public sewerage system or designated disposal site by one of the following methods:

a. By burial under 36 inches of earth on the premises on which produced at a distance of at least 50 feet from a well or if on other premises at a distance of at least 500 feet from a place of habitation provided that there is also at least 36 inches of soil between the buried sludge and the high ground water level or bedrock.

b. By spreading on land, not used for pasturing livestock or for growing vegetables, at a distance of at least 1,000 feet from a place of habitation or any stream, lake, pond or flowage.

4. Prohibited sites. The sludge shall not be disposed of by discharge into a lake, stream, ditch or dry run or be buried within 50 feet of such watercourses or in a flood plain.

(7) **HOLDING TANKS.** (a) *Approval.* Holding tanks shall be considered on an individual basis. Three complete sets of plans shall be submitted to the department for each request to install a holding tank. The installation of the holding tank shall be made in accord with the following criteria.

(b) *Installation.* 1. Materials. The tank shall be constructed of material approved by the department.

2. Location. Tanks shall be located in accord with subsection H 62.20 (2) (c) except the tanks shall be 20 feet from a building or its appendage.

3. Capacity. Tanks shall have a minimum 5-day holding capacity. Sizing shall be based in accord with section H 62.20 (4) (b).

4. Warning device. A high water warning device shall be installed. This device shall be either an audible or an illuminated alarm. If the latter, it shall be conspicuously mounted.

5. Manhole. Each tank shall be provided with a round manhole at least 24-inch inside diameter extending at least 6 inches above ground surface. Each manhole cover shall have an effective locking device.

6. Septic tank. If an approved septic tank is installed to serve as a holding tank, the inlet and outlet baffles shall be removed and the outlet sealed.

7. Vent. Each tank shall be provided with a minimum 2-inch fresh air inlet extending 12 inches above final grade terminating with a return bend fitting.

8. Servicing. Holding tanks shall be serviced in accord with chapter 146, Wis. Stats., Wis. Adm. Code chapter RD 13, and subsection H 62.20 (6).

History: 1-2-56; am. (1) (f), Register, June, 1956, No. 6, eff. 7-1-56; am. (2) (a), (2) (b), (2) (c) 2, Register, February, 1957, No. 14, eff. 3-1-57; am. (1) (b), (d) and (e), Register, April, 1962, No. 76, eff. 10-1-62; r. and recr. Register, November, 1969, No. 167, eff. 12-1-69; am. (5) (d) 2. e., Register, October, 1971, No. 190, eff. 11-1-71.

Register, October, 1971, No. 190

H 62.21 Inspection and tests. (1) STATE APPROVED INSTALLATIONS. Plumbing installations in newly annexed territory complying with the requirements of the state code shall be approved by the local governing body of the municipality of which such territory becomes a part, and the owner of the property shall be granted permission to connect to the public water supply and sewerage system upon the payment of permit fees where such fees are required.

(2) **LOCAL INSPECTION. (a) Testing.** All piping of a drainage or plumbing system in cities and villages having local plumbing supervisors, except in case of repairs as specified in H 62.21 (6), shall be tested by the plumber in charge, in the manner herein provided, in the presence of the local supervisor of plumbing or his authorized deputies. The material and labor for tests shall be furnished by the plumber in charge.

(b) *Notice for inspection.* The plumber in charge or the owner of the property in case no plumber is employed, shall notify the supervisor in person, by telephone or in writing when the work is ready for inspection. If the inspection is not made within a reasonable time after the notice is given, the plumber in charge, or the owner, may proceed with the work.

(c) *Preparations for inspection.* When work is ready for inspection the plumber in charge, or in case none is employed, the owner, shall make such arrangements as will enable the supervisor to reach all parts of the building readily, shall have present the proper apparatus and appliances for making the tests, and shall furnish such assistance as may be necessary in making proper inspection.

(d) *House drain tests.* The entire house drain with all its branches, receptacles and connections shall be brought so far as practicable to the surface or grade of basement floor and tested with water or air. Upon being found free from defects and leaking joints, the test shall be considered satisfactory.

(e) *Stable and garage tests.* If a stable, garage or any part thereof is used for human habitation, or is so constructed that it may be used as such, the same tests shall be made as for an ordinary dwelling.

(f) *Rain leader tests.* Rain water leaders and their roof connections where they are permitted within the walls of any building, and such branches as connect with the house drain 3 feet beyond basement wall shall be tested with water or air.

(g) *Soil, waste, and vent tests.* Soil, waste and vent pipes, rain water leaders and all work known as "roughing in and underfloor work" between the house drain connections to points above the finished floor and beyond the finished face of walls and partitions shall be tested.

(h) *Water and air test.* The water test shall be applied by closing all openings in the pipes with proper testing plugs, to the highest opening above the roof, and completely filling the system with water, or an air test with pressure of at least 5 pounds shall be used. If the pipes are found free from defects and leaking joints, the test shall be considered complete and satisfactory. Buildings five stories or more in height may be tested in sections as directed by the plumbing supervisor.

(i) *Smoke test.* The smoke test shall be used in testing the sanitary condition of the drainage or plumbing system of all buildings where there is reason to believe it has become dangerous or defective. The smoke machine shall be connected to any suitable opening or outlet in the system. When the system is filled completely with dense pungent smoke, all openings emitting smoke, the openings shall be closed and an air pressure equivalent to a one-inch water column applied for a period of at least 10 minutes. If there is no leakage or forcing of trap seals, the systems shall be considered air and gas tight. Nothing, however, in this section shall be construed to prohibit the removal of any clean-out or the unsealing of a trap to ascertain if the smoke has reached all parts of the system.

(3) **COVERING OF WORK.** No part of any plumbing or drainage system shall be covered until it has been inspected, tested and approved. If any part is covered before being tested and approved, it shall be uncovered at the direction of the supervisor.

(4) **FINAL INSPECTION.** When the plumbing or drainage system is completed and fixtures are installed the final inspection shall be made.

(5) **INSPECTION FOR CHANGES OR ALTERATIONS.** When additional fixtures are installed or the style or location of any fixture is changed or when changes are made in the piping system, the work shall be inspected.

(6) **TESTS FOR REPAIRS.** Inspections may be made, but tests shall not be required after the repairing or replacing of any old fixture, faucet or valve by a new one to be used for the same purpose, forcing out stoppage, repairing leaks or relieving frozen pipes and fittings. Such repairs or alterations may not be construed to include cases where new vertical or horizontal lines of soil, waste, vent, or interior rain water leaders are used or their relative locations changed. In a building condemned by the proper authorities because of insanitary conditions of house drainage or plumbing, such repairs or alterations as are necessary to make the plumbing sanitary shall be made to conform to the provisions of this code. Tests and inspections of such alterations shall be made as for new buildings.

Note: No test nor inspection shall be required where a house drainage and plumbing system or part thereof is set up for exhibition purposes; nor shall a test be required (although inspection may be made) where the plumbing is placed in an out-house, stable or detached building used exclusively for such purpose.

(7) **DEFECTS IN MATERIALS.** If tests or inspection discloses defective material, leakage, or unworkmanlike construction, which does not conform to the requirements of this code, and which is condemned by the supervisor of plumbing the same shall be removed and replaced within three days, and when necessary retested. The presence of any foreign substance, other than that provided for in this code, about a joint or any part of a plumbing or drainage system shall be sufficient cause for condemning such joint or part of the system. Any split fittings, hubs or defective material which do not conform to the requirements of this code, and which have been condemned by the supervisor, shall be removed from the work and not used again.

Note: Poor workmanship design or methods of installation likewise shall be sufficient cause for the condemnation of the whole or any part of the system.

II 62.22 History: 1-2-56; r. Register, October, 1971, No. 190, eff. 11-1-71.

II 62.24 History: 1-2-56; renum. from 62.23, Register, February, 1957, No. 14, eff. 3-1-57; r. Register, October, 1971, No. 190, eff. 11-1-71.

Register, October, 1971, No. 190

Chapter H 63

RESTRICTED AND TENTATIVE APPROVALS

H 63.05 Plastic pipe

H 63.01 History: 1-2-56; am. Register, October, 1961, No. 70, eff. 11-1-61; r. Register, October, 1971, No. 190, eff. 11-1-71.

H 63.02 History: 1-2-56; r. Register, October, 1961, No. 70, eff. 11-1-61.

H 63.03 History: 1-2-56; r. Register, October, 1971, No. 190, eff. 11-1-71.

H 63.04 History: 1-2-56; r. Register, October, 1971, No. 190, eff. 11-1-71.

H 63.05 Plastic pipe. (1) USE LIMITATIONS. Plastic pipe conforming to specifications set forth in subsection (2) may be installed in lieu of materials specified in chapter H 62 for the following uses:

(a) Underground pressure piping in potable cold water system serving private residences and farm buildings except those located within the incorporated limits of any city or village having either a public water or sewer system and within areas platted under ch. 236, Wis. Stats., adjacent to such city or village and within the limits of any metropolitan sewerage district.

(b) For other uses as may be approved by the board when such installations will provide additional experience in the use of plastic pipe.

(2) SPECIFICATIONS. Plastic pipe and fittings shall conform to the following:

(a) All pieces shall be marked with the seal of approval of the National Sanitation Foundation, the pressure rating and the manufacturer's name or trademark.

(b) The minimum allowable working pressure at a temperature of 73.4° Fahrenheit shall be based on the maximum pressure in the water system and be as follows:

Maximum Water System Pressure Pounds Per Square Inch	Allowable Working Pressure Pounds Per Square Inch
Less than 50 -----	75
50 to 75 -----	100
75 to 100 -----	125

(3) INSTALLATION. The installation of plastic pipe shall conform to the following requirements:

(a) For the use permitted under subsection (1) (a) the piping shall terminate outside the walls of any building served and shall not be installed in any tunnel or pipe chase that is heated or contains hot water or steam piping.

(b) Joints shall be assembled in such manner as to assure permanence. Any cement or solvent used shall be free of ingredients that are toxic or will produce odors in the water. Any metal clamps used shall be corrosion resistant and homogeneous throughout.

(c) The pipe trench shall have a smooth compacted bottom. Where rock or stone is encountered, the trench shall be backfilled with sand or stone-free soil for a depth of 2 to 3 inches.

(d) With thermo-plastic pipe an extra one inch of length shall be provided for every 8 feet of measured length of installation. Before backfilling, water at well temperature shall be discharged through the pipe until it reaches the approximate temperature of the water.

(e) The first 6 inches of backfill material shall be free of rocks or clods and shall be carefully placed by hand.

(f) Pipe size and other installation requirements shall be in accord with provisions of chapter H 62.

(4) **REPORTS.** Any failures in plastic pipe installations shall be reported to the board by the owner or person making the repairs to the system. If the failure occurs in a section of pipe or in a fitting, the part failing should be submitted to the board for examination. External causes contributing to a failure should be thoroughly explained.

History: Cr Register, February, 1957, No. 14, eff. 3-1-57.