



---

**TELECONFERENCE/VIRTUAL  
PRIVATE ONSITE WASTEWATER TREATMENT SYSTEMS (POWTS)  
TECHNICAL CODE ADVISORY COMMITTEE  
Room N206, 4822 Madison Yards Way, Madison, WI  
Contact: Bradley Johnson (608) 266-2112  
April 26, 2019**

*The following agenda describes the issues that the Committee plans to consider at the meeting. At the time of the meeting, items may be removed from the agenda. Please consult the meeting minutes for a record of the actions of the Committee.*

**AGENDA**

**9:00 A.M.**

**OPEN SESSION – CALL TO ORDER – ROLL CALL**

**A. Adoption of Agenda (1)**

**B. Approval of Minutes for February 8, 2019 (2)**

**C. Administrative Matters – Discussion and Consideration**

1. Committee, Department, and Staff Updates

**D. Technical Advisory Matters - Discussion and Consideration (3-74)**

1. Recommendation Guide for Component Manuals
2. Recommendation Guide for POWTS Products
3. New Eljen Mound in a Box Component Manual

**E. Public Comments**

**ADJOURNMENT**

\*\*\*\*\*

MEETINGS AND HEARINGS ARE OPEN TO THE PUBLIC, AND MAY BE CANCELLED WITHOUT NOTICE.

Times listed for meeting items are approximate and depend on the length of discussion and voting. All meetings are held at 4822 Madison Yards Way, Madison, Wisconsin, unless otherwise noted. In order to confirm a meeting or to request a complete copy of the council's agenda, please call the listed contact person. The council may also consider materials or items filed after the transmission of this notice. Times listed for the commencement of disciplinary hearings may be changed by the examiner for the convenience of the parties. Interpreters for the hearing impaired provided upon request by contacting the Affirmative Action Officer, 608-266-2112.

**POWTS TECHNICAL ADVISORY COMMITTEE  
MEETING MINUTES  
FEBRUARY 8, 2019**

**PRESENT:** Frederick Hegeman, Daniel Keymer, Robert Schmidt, Daniel Vander Leest, Eric Wellauer

**STAFF:** Bradley Johnson, Section Chief; Tim Vander Leest, DIS Staff; Kate Stolarzyk, Bureau Assistant; and other Department staff

Bradley Johnson, Section Chief, called the meeting to order at 9:01 a.m. A quorum of five (5) members were present.

**ADOPTION OF AGENDA**

**MOTION:** Robert Schmidt moved, seconded by Daniel Vander Leest, to adopt the agenda as published. Motion carried unanimously.

**APPROVAL OF MINUTES APRIL 24, 2018**

**MOTION:** Robert Schmidt moved, seconded by Daniel Vander Leest, to approve the minutes of April 24, 2018 as published. Motion carried unanimously.

**New Eljen Mound in a Box Component Manual**

**MOTION:** Eric Wellauer moved, seconded by Daniel Vander Leest, to recommend DSPP staff to request additional information from Eljen regarding decreased sizing and potential limitations in gas exchange. Motion carried. Robert Schmidt.

**SPS 383.71 “Performance Monitoring”**

**MOTION:** Eric Wellauer moved, seconded by Robert Schmidt, to request DSPP to explore funding mechanisms to support POWTS performance monitoring pursuant to subchapter VII of the Wisconsin Administrative Code ch. SPS 383, more specifically to consider identifying funds currently utilized to support the Wisconsin Fund Program or other potential sources such as groundwater fees of the Wisconsin Groundwater Law, POWTS Plan Review, or POWTS sanitary fees. The State of Wisconsin does not currently monitor the performance of the varying types of POWTS installed in Wisconsin and the impacts to groundwater. Motion carried unanimously.

**ADJOURNMENT**

**MOTION:** Robert Schmidt moved, seconded by Eric Wellauer, to adjourn the meeting. Motion carried unanimously.

The meeting was adjourned at 2:58 p.m.

## **POWTS Technical Advisory Committee Guide for Component Manuals**

- **Format of the Manual**
  - Understandable format
    - Similar to existing DIS approved manuals
  - Consistency
    - Other manuals by the same manufacturer or wholesaler
  - Sizing information for residential and commercial
    - Is it similar to DSPS 383?
    - How does it handle high strength waste?
  - Sizing information for the products used
    - How are the proprietary components sized?
    - Are the products approved?
    - Are they sized for other component manuals?
  - Standardized terms and definitions
    - Are the terms compatible with DSPS 381?
    - Have other manuals been approved with similar terms that are not the same?
  - Sample sizing, diagrams, and illustrations
    - Illustrations and diagrams are clear and useful
    - Practical sample sizing
  - Is there too much information?
    - Can the installer, reviewer, or inspector find the needed information?
    - Is there duplicated information in the manual?
    - Is it a sales brochure?
- **Testing of the Manual Information and Theory**
  - What testing data will the TAC accept?
  - NSF
    - Length of testing
    - Type of testing
    - Testing procedures
    - Does the testing represent proposed installation and sizing conditions?
  - State of WI
    - Has the DIS approved ISD of the proposed component manual?
    - Experimental systems
    - DNR
  - Other States
    -
  - Other testing Agencies
    -
  - Company testing
    - Performance testing by the component manufacturer
    - Is the testing relevant?
    - Any testing data by the manufacturer's reps or wholesalers?
  - Field testing

- Reports from installers
  - Feedback from installers
- WOWRA, Precast Association
  -
- **Theory of the system**
  - Does the manual use existing theories on POWTS?
  - Does the manual amend an existing manual?
  - Does the manual use existing practices and techniques?
  - Does the manual use technologies new to Wisconsin?
  - Does the manual use technologies new to POWTS?
  - Does the manual use techniques that will work in Wisconsin?
  - Does the manual use techniques that have been designed for Wisconsin weather?
- **Designing the system**
  - Is the design of the system understandable?
  - Is the math for the design of the system explained?
  - Is the math for the design of the system automated? (crew file)
  - Where can the design go wrong?
- **Installation**
  - Is the POWTS System installable?
  - Does it require specialized tools?
  - Does it require specialized materials?
  - Does it contain readily accessible products?
  - Are there any installation procedures that may not work?
  - Where are the potential pitfalls or errors in the installation?
- **Education for the Component Manual**
  - Education of State plan reviewers
  - Education of County plan reviewers and inspectors
    - What education will plan reviewers need to be able to approve the plans?
    - Who provides that education/training?
    - What do inspectors need to focus on when inspecting in the field?
    - What are the critical installation points?
  - Education for installers
    - Do installers need to be trained on the installation?
    - Is Certification required?
    - Who provides the education/training?

What testing data will the TAC Accept?

What testing agencies will the TAC Accept?

Dosed vs gravity vs pressure distributed?

Common Practices?

## POWTS Technical Advisory Committee Guide for Products

- **Format of the Product Information**
  - Understandable format
    - Similar to existing DIS approved products
  - Consistency
    - Other products by the same manufacturer or wholesaler
  - Sizing information for the product
    - Is it similar to DSPS 383?
    - How does it handle high strength waste?
    - How are the proprietary components sized?
    - Are they sized for other component manuals?
  - Standardized terms and definitions
    - Are the terms compatible with DSPS 381?
  - Sample sizing, diagrams, and illustrations
    - Illustrations and diagrams are clear and useful
    - Practical sample sizing
  - Is there too much information?
    - Can the installer, reviewer, or inspector find the needed information?
    - Is there duplicated information in the manual?
    - Is it a sales brochure?
- **Testing of the Product Information and Theory**
  - What testing data will the TAC accept?
  - NSF
    - Length of testing
    - Type of testing
    - Testing procedures
    - Does the testing represent proposed installation and sizing conditions?
  - State of WI
    - Has the DIS approved ISD of the proposed component manual?
    - Experimental systems
    - DNR
  - Other States
    -
  - Other testing Agencies
    -
  - Company testing
    - Performance testing by the component manufacturer
    - Is the testing relevant?
    - Any testing data by the manufacturer's reps or wholesalers?
  - Field testing
  - Reports from installers
    - Feedback from installers
  - WOWRA, Precast Association

- **Theory of the Product**
  - Does the Product use existing theories on POWTS?
  - Does the Product amend an existing product?
  - Does the Product use existing practices and techniques?
  - Does the Product use technologies new to Wisconsin?
  - Does the Product use technologies new to POWTS?
  - Does the Product use techniques that will work in Wisconsin?
  - Does the Product use techniques that have been designed for Wisconsin weather?
- **Design of the Product**
  - Is the design of the product understandable?
  - Is the sizing for the product explained?
  - Is the sizing automated? (crew file)
  - Where can the sizing go wrong?
- **Installation**
  - Is the POWTS Product installable?
  - Does it require specialized tools?
  - Does it require specialized materials?
  - Are there any installation procedures that may not work?
  - Where are the potential pitfalls or errors in the installation?
  - What is the required maintenance?
  - Who can maintain the product?
- **Education for the Component Manual**
  - Education of State plan reviewers
  - Education of County plan reviewers and inspectors
    - What education will plan reviewers need to be able to approve the plans?
    - Who provides that education/training?
    - What do inspectors need to focus on when inspecting in the field?
    - What are the critical installation points?
  - Education for installers
    - Do installers need to be trained on the installation?
    - Is Certification required?
    - Who provides the education/training?

What testing data will the TAC Accept?

What testing agencies will the TAC Accept?

Dosed vs gravity vs pressure distributed?

Common Practices?



Governor Scott Walker    Laura Gutierrez, Secretary

March 28, 2018

ELJEN CORPORATION  
JIM KING  
125 MCKEE STREET  
EAST HARTFORD CT 06108

Re: Description:            POWTS COMPONENT MANUAL  
Manufacturer:            ELJEN CORPORATION  
Product Name:            (trans id 3082680) ELJEN GSF MOUND COMPONENT MANUAL  
Model Number(s):        A42 AND B43  
Product File No:        20180090  
Fee Received:            \$400.00  
Date Received:          3/21/2018

This letter is to acknowledge receipt of the information and/or fee you recently sent to us for this plumbing product. We received the information and/or fee on the date indicated in the regarding line.

This information will be reviewed by the POWTS Technical Advisory Committee.

The product file number shown in the regarding line of this letter must be provided when contacting us about this product review.

Sincerely,

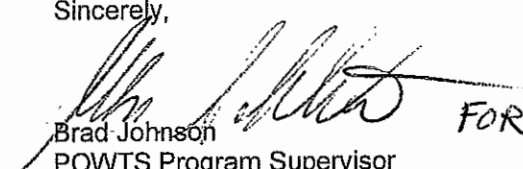
 *FOR*  
Brad Johnson  
POWTS Program Supervisor  
2331 San Luis Pl #150  
Green Bay, WI 54304  
920-492-5605 Phone  
Bradley.Johnson@Wisconsin.gov Email

Wisconsin Department of Safety and Professional Services  
 Division of Industry Services  
 1400 East Washington Avenue  
 PO Box 7302  
 Madison WI 53707-7302

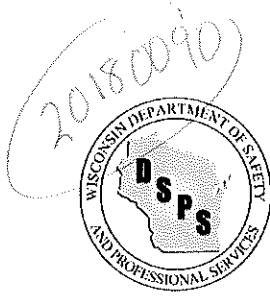

Phone: 608-266-2112  
 Web: http://dps.wi.gov  
 Email: dps@wisconsin.gov

Scott Walker, Governor  
 Laura Gutierrez Secretary

## Plumbing Standard or Product Review Application

Personal information you provide may be used for secondary purposes Privacy Law, s. 15.04(1)(m).

This page may be utilized for fax appointments

Complete and indicate date plans will be in our office

3082680  
 Schluter  
 3/26/18

**Instructions:** Only one review request may be submitted on this application. Type or clearly print in ink all the requested data. The submitting party must be the manufacturer or the manufacturer's representative. Submit this application to the address shown in the upper right corner. Lists of information required for product review are available from the division.

**Make checks payable to: State of WI - DPCS.**

1. Manufacturer or Standard Org. Information*			2. Submitting Party Information*		
Contact Person: Jim King			Contact Person: Jim King		
Manufacturer or Standard Organization Name: Eljen Corporation			Company or Standard Organization Name: Eljen Corporation		
A Division of:			A Division of:		
No. & Street or P. O. Box 125 McKee St			No. & Street or P. O. Box 125 McKee St		
City, Town, or Village East Hartford	State CT	Zip Code: 06108	City, Town, or Village East Hartford	State CT	Zip Code: 06108
Country If Other Than United States:			Country If Other Than United States:		
Telephone No. (include area code) 800-444-1359	Fax No. (include area code) 880-610-0427		Telephone No. (include area code) 800-444-1359	Fax No. (include area code)	
E-Mail (contact person or general) jking@eljen.com			E-Mail (contact person or general) jking@eljen.com		
Web Access Address www.eljen.com			Web Access Address www.eljen.com		

\* It is the responsibility of the manufacturer to keep their contact information current and accurate

### 3. Product Information

Existing Product File No. (if any) 20150018	Product Name: Eljen GSF Mound Component Manual
Model Number(s) - use extra paper if necessary: A42 and B43	Product Description: POWTS COMPONENT MANUAL - MOUND IN A BOX

### 4. Submittal Type and Required Fees (Check only one box below at left and enter applicable single fee at right for that box.)

	New Review	Revision or Renewal	Fee Required
<input type="checkbox"/> Health care plumbing appliance	\$250.00	\$125.00	
<input type="checkbox"/> Prefabricated plumbing	\$250.00	\$125.00	
<input type="checkbox"/> Chemical or biochemical treatment for POWTS	\$250.00	\$125.00	
<input type="checkbox"/> Physical or chemical restoration process for POWTS	\$250.00	\$125.00	
<input type="checkbox"/> Prefabricated holding or treatment component for POWTS (see note 1)	\$250.00	\$125.00	
<input type="checkbox"/> Voluntary POWTS component review in accordance with s. SPS 384.10 (3)	\$400.00	\$150.00	
<input type="checkbox"/> Wastewater treatment device used to meet the requirements in s. SPS 382.70	\$250.00	\$125.00	
<input type="checkbox"/> Water treatment device (see note 5) (water softener manufacturers/submitters see note 2)	\$250.00	\$125.00	
<input checked="" type="checkbox"/> Alternate approval in accordance with s. SPS 384.50	\$400.00	\$200.00	\$400.00
<input type="checkbox"/> Experimental approval in accordance with s. SPS 384.50	\$1,000.00	\$500.00	
<input type="checkbox"/> Alternate standard in accordance with s. SPS 381.20 (2) (see notes 3, 4)	\$500.00	\$250.00	
<input type="checkbox"/> Minor revision, name and/or address for change of manufacturer's or standard organization (see reverse side)	(Complete information on see reverse side)		

SBD-7966 (R02/17)

MAR 21 2018  
 Division of Industry Services  
 Page 1 of 3



**Notes:**

1. Prefabricated holding or treatment component for POWTS includes items such as anaerobic and aerobic treatment tanks, holding tanks, pump tanks, siphon tanks, sedimentation tanks, and trash tanks.
2. Water softeners that are tested and listed, FOR ALL ADVERTISED CLAIMS, by an ANSI accredited listing agency under NSF/ANSI Standard 44 are exempt from product review and approval.
3. See appendix SPS A-384.11 for list of nationally recognized listing agencies acceptable to the department. The list includes AGA, ASME, ASSE, CSA, IAPMO, ITS, NSF, WQA, and UL.
4. Alternate standards submitted on this form only apply to those standards used in plumbing systems, which are governed by this department.
5. The specific categories of water treatment devices subject to review and approval include:
  - a. All residential water treatment devices. "Residential" is defined as one- and two-family dwellings, or up to two dwelling units in a multi-family dwelling.
  - b. In-store, consumer self-service, bottled water vending machines.
  - c. Commercial water treatment devices installed on non-transient, non-community (NTNC) and transient non-community (TNC) private water supplies to treat contaminants regulated under ch. NR 809, Wis. Adm. Code; and aesthetic commercial water treatment devices installed on NTNC or TNC private water supplies as required pre-treatment for commercial water treatment devices installed on non-transient, non-community (NTNC) and transient non-community (TNC) private water supplies to treat contaminants regulated under ch. NR 809.

**Additionally: This form, and the guidance document "Required Information for the Review of Water Treatment Devices", is for use with water treatment devices that are intended for marketing and sales statewide. For site-specific designs, please refer to the General Plumbing Application form (SBD-6154) and associated guidance document "Required Information for the Review of Plumbing Plans for Site Specific Water Treatment Devices."**

**Minor revision and/or change of name and/or address for Manufacturer or Standard Organization**

Fee = \_\_\_\_\_ # of files x \$10.00 + \$70.00 = \_\_\_\_\_  
(Enter calculated fee on front of form)

**Note:** Request for revision in accordance with s. SPS 302.66 (1) (c) b. or (2) (b) is not applicable if product is submitted with fees for revision or renewal. The expiration date of the original approval(s) will not be extended if the minor revision is approved. This fee does not apply if done at time of revision or renewal.

Current file numbers affected: (list in numerical order)

Former Manufacturer's or Standard Organization Name and Address information:			New Manufacturer's or Standard Organization Name and Address information:		
Contact Person:			Contact Person:		
Manufacturer or Standard Organization Name:			Manufacturer or Standard Organization Name:		
A Division of:			A Division of:		
No. & Street or P. O. Box			No. & Street or P. O. Box		
City, Town, or Village	State	Zip Code:	City, Town, or Village	State	Zip Code:
Country If Other Than United States:			Country If Other Than United States:		
Telephone No. (include area code)			Telephone No. (include area code)		
FAX No. (include area code)			FAX No. (include area code)		
Email (contact person or general):			Email (contact person or general):		
Web Address:			Web Address:		

**Briefly describe the minor revision (include Product File No. where appropriate):**

A new configuration for the design and construction of a mound.

# GSF MOUND IN A BOX COMPONENT MANUAL

March 2018

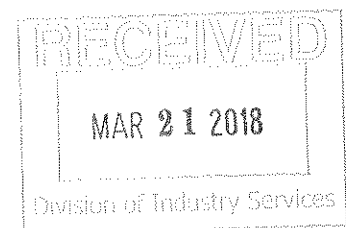

Table of Contents	Page
I. INTRODUCTION AND SPECIFICATIONS.....	3
II. DEFINITIONS.....	10
III. DESCRIPTION AND PRINCIPLE OF OPERATION.....	11
IV. SOIL AND SITE REQUIREMENTS.....	11
V. FILL AND COVER MATERIAL.....	12
VI. DESIGN.....	13
VII. SITE PREPARATION AND CONSTRUCTION.....	23
VIII. OPERATION, MAINTENANCE AND PERFORMANCE MONITORING .....	25
IX. REFERENCES .....	27
XI. EXAMPLE GSF MOUND IN A BOX WORKSHEET .....	28
XI. EXAMPLE GSF MOUND IN A BOX WORKSHEET COMPLETED.....	35
XII. PLAN SUBMITTAL AND INSTALLATION INSPECTION .....	41
XIII. POWTS INSPECTION REPORT .....	43

**Published by:**  
**Eljen Corporation**  
**125 McKee St.**  
**East Hartford, CT 06108**

**This component manual was produced exclusively by Eljen Corporation for use with Eljen GSF products. This manual is based upon the “Mound Component Manual for Onsite Wastewater Treatment Systems” Ver. 2.0, Jan. 30, 2001, by the State of Wisconsin, Department of Safety and Professional Services.**

**Eljen Corporation reserves the right to revise this component manual according to changes in regulations or Eljen GSF system installation instructions.**

I. INTRODUCTION AND SPECIFICATIONS

This Private Onsite Wastewater Treatment System (POWTS) component manual provides design, construction, inspection, operation, and maintenance specifications for an GSF mound in a box component. However, these items must accompany a properly prepared and reviewed plan acceptable to the governing unit to help provide a system that can be installed and function properly. Violations of this manual constitute a violation of chs. SPS 383 and 384, Wis. Adm. Code. The mound in a box component must receive influent flows and loads less than or equal to those specified in Table 1. When designed, installed and maintained in accordance with this manual, the mound in a box component provides treatment and dispersal of domestic wastewater in conformance with ch. SPS 383 of the Wis. Adm. Code. Final effluent characteristics will comply with s. SPS 383.41, Wis. Adm. Code when inputs are within the range specified in Tables 1 to 3.

Note: Detailed plans and specifications must be developed and submitted to be reviewed and approved by the governing unit having authority over the plan for the installation. Also, a Sanitary Permit must be obtained from the department or governmental unit having jurisdiction. See Section XII for more details.

Table 1 Influent Flows and Loads	
Design Wastewater flow (DWF)	≤ 5000 gal/day
Monthly average value of Fats, Oil and Grease (FOG)	≤ 30 mg/L
Monthly average value of five day Biochemical Oxygen Demand (BOD <sub>5</sub> )	≤ 220 mg/L
Monthly average value of Total Suspended Solids (TSS)	≤ 150 mg/L
Design loading rate of fill	≤ 2.0 gal/ft <sup>2</sup> /day if BOD <sub>5</sub> and TSS ≤ 30 mg/L
Design loading rate of the basal area	= soil application rate of effluent with maximum monthly average values of BOD <sub>5</sub> and TSS of ≤ 30 mg/L when distribution component receives effluent with a BOD <sub>5</sub> and TSS of ≤ 30 mg/L or when fill material depth is ≥ 12 inches as measured at the D dimension.
Maximum volume of a single dose to absorption component when pumps or siphons are employed in the design	A42 = 3 gallons/dose/unit B43 = 4 gallons/dose/unit
Design wastewater flow (DWF) from one and two-family dwellings	Based on s. SPS 383.43 (3), (4), or (5), Wis. Adm. Code

Table 1 INFLUENT FLOWS AND LOADS (continued)	
Design wastewater flow (DWF) from public facilities	≥ 150% of estimated daily wastewater flow in accordance with Table 4 of this manual or s. SPS 383.43 (6), Wis. Adm. Code
Linear loading rate for systems with in situ soils having a soil application rate of ≤ 0.3 gal/ft <sup>2</sup> /day within 12 inches of fill material	≤ 4.5gal/ft/day
Wastewater particle size	≤ 1/8 inch

Table 2a SIZE AND ORIENTATION	
Distribution cell width (A) <sup>a</sup>	≤ 10 feet = Number of product rows x product width. Product width is shown in Table 2c; multiple product rows are acceptable
Required # of Products	≥ Design wastewater flow rate ÷ design loading rate of the fill material ÷ square footage of product (shown in Table 2b), round up to nearest whole number; Min 5 B43 units per bedroom or 6 A42 units per bedroom in residential applications
Distribution cell length (B) <sup>a</sup>	Multiple # of Products x 4 ÷ # of Rows + 1
Total distribution cell area (A x B) <sup>a</sup>	A x B
Orientation	Longest dimension parallel to surface grade contours on sloping sites.
Deflection of distribution cell on concave slopes	≤ 10%
Fill material depth at up slope edge of distribution cell (D) <sup>a</sup>	Min. 1 ft of fill material at up slope edge
Distribution cell depth (F) <sup>a</sup>	Product height shown in Table 2b
Depth of cover material at top center of distribution cell area (H) <sup>a</sup>	≥ 12 inches
Depth of cover material at top outer edge of distribution cell area (G) <sup>a</sup>	≥ 6 inches
Basal area	≥ Design wastewater flow rate ÷ Design loading rate of basal area as specified in Table 1
Soil Application Rate	The designer may use Effluent #2 in accordance with s. SPS Table 383.44-1 and 383.44-2, Wis. Adm. Code
Note a: Letter corresponds to letters referenced in figures, formulas and on worksheets.	

Table 2b APPROVED PRODUCT MODEL NUMBERS AND SQUARE FOOTAGE PER PRODUCT				
Product	Square Footage	Product Width with Sand	Product Length	Product Height
A42	12 square feet per unit	36"	48"	7"
B43	16 square feet per unit	48"	48"	7"

Table 2c APPROVED PRODUCT INSTALLATIONS AND SQUARE FOOTAGE				
Product	Square Footage	Installation Width	Installation Length	Install Height
A42	12 square feet per unit	36"	48"	19"
	16 square feet per unit	48"	48"	19"
	20 square feet per unit	60"	48"	19"
B43	16 square feet per unit	48"	48"	19"
	20 square feet per unit	60"	48"	19"
	24 square feet per unit	72"	48"	19"

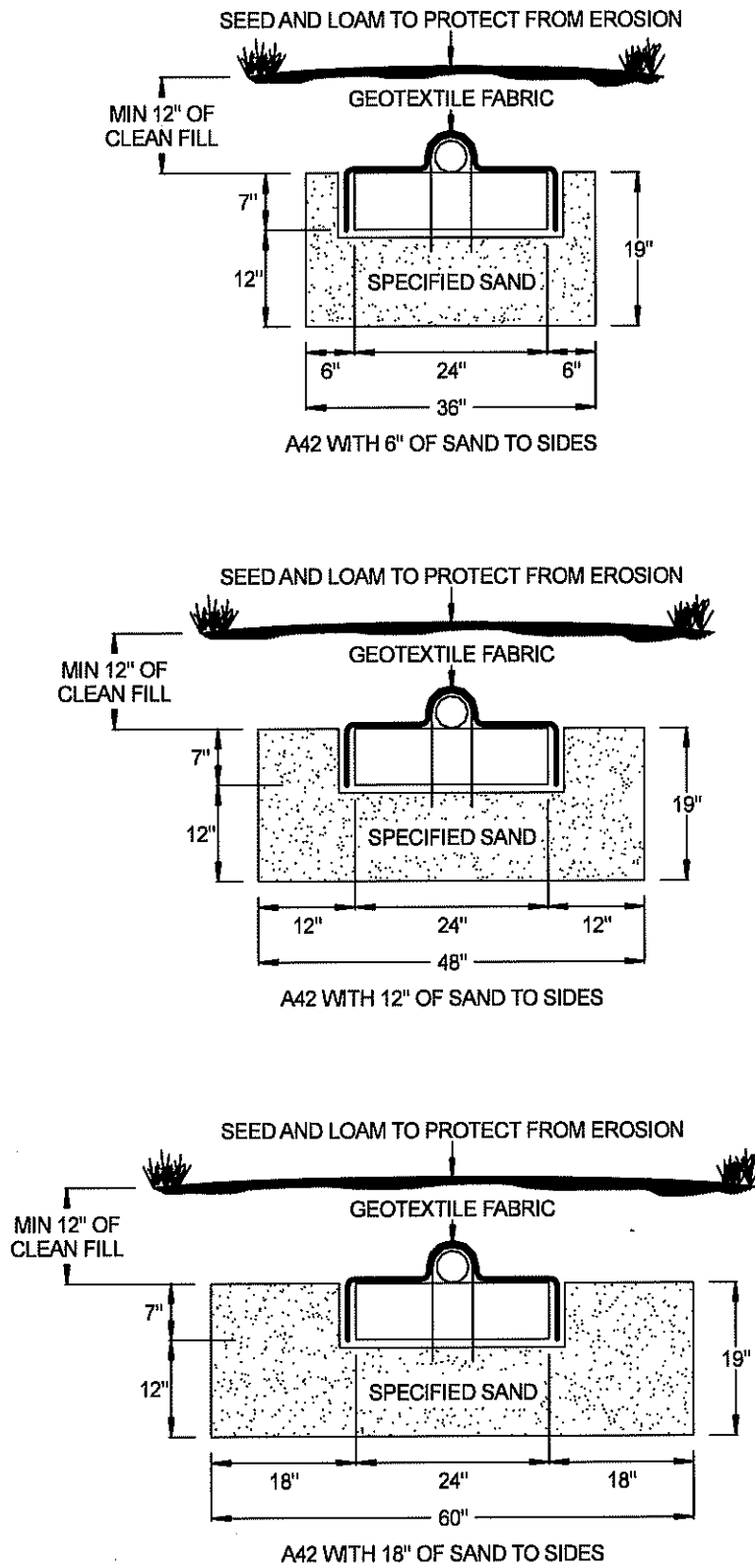

Figure 1. A42 Single Lateral In-Ground Cross Sections

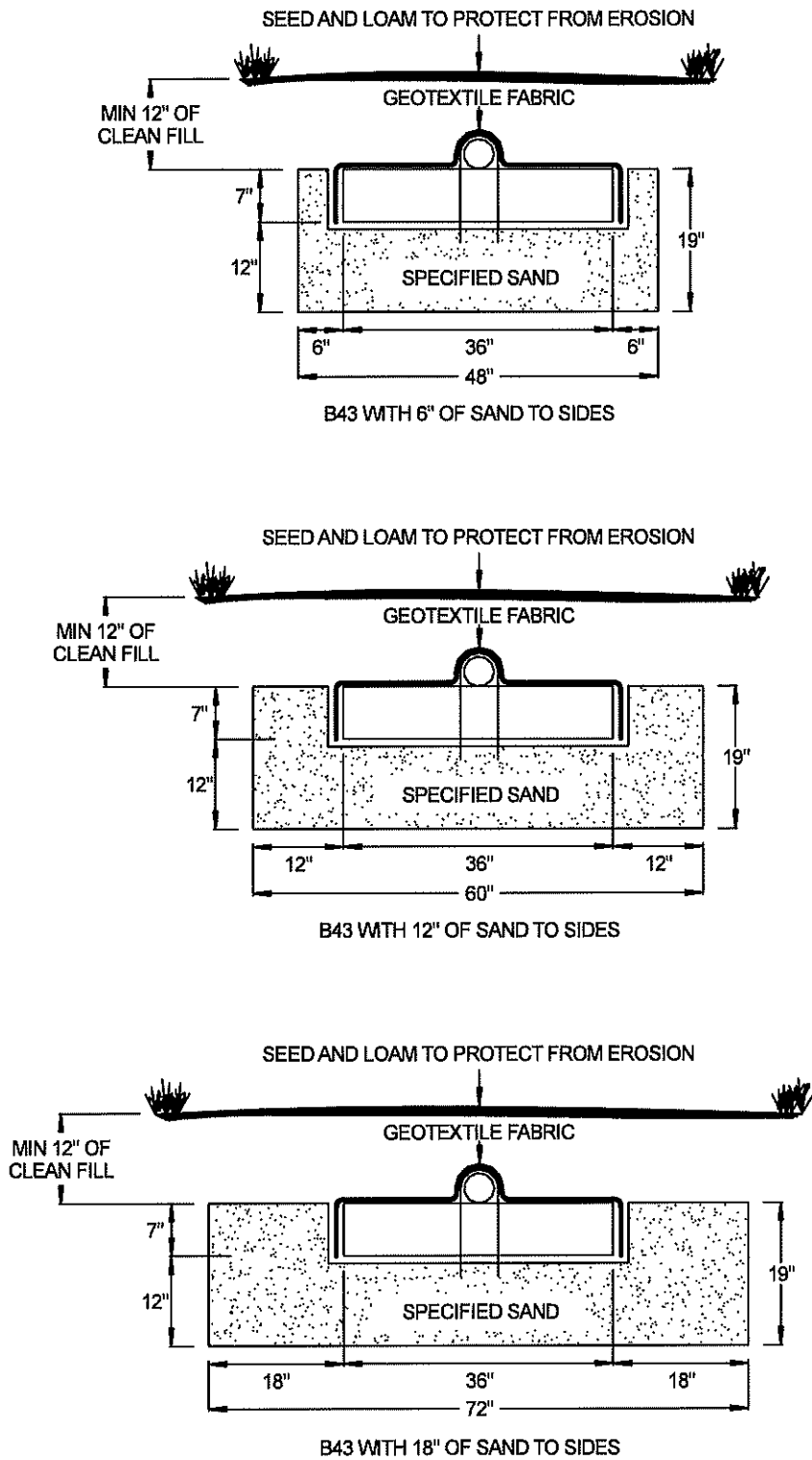

Figure 2. B43 Single Lateral In-Ground Cross Sections



**Table 3  
OTHER SPECIFICATIONS**

Bottom of distribution cell	Level
Slope of original grade	≤ 25% in area of basal area of the box
Depth of in situ soil to high groundwater elevation and bedrock under basal area	≥ 6 inches
Vertical separation between distribution cell infiltrative surface and seasonal saturation defined by redoximorphic features, groundwater, or bedrock	≥ 3 ft. measured to the bottom of the GSF unit. ≥ 2ft. measured to the bottom of the GSF system sand.
Fill material	Meets ASTM Specification C-33 for fine aggregate
Size for basal area (for level sites) (B x W) <sup>a</sup>	Cell length x [Total mound width]
Size for basal area (for sloping sites) (B x {A + I}) <sup>a</sup>	Cell length x [(# of cells x cell width) + {(# of cells - 1) x cell spacing} + down slope berm]
Observation Pipe Material	<p>Observation pipes will be installed in each distribution cell so as to be representative of a cell's hydraulic performance.</p> <ul style="list-style-type: none"> <li>• be located such that there are a minimum of two installed in each dispersal cell at opposite ends from one another</li> <li>• be located near the dispersal cell ends</li> <li>• be at least 6 inches from the end wall and sidewall</li> <li>• be installed at an elevation to view the horizontal or level infiltrative surface within the dispersal cell.</li> </ul>

**Table 3  
OTHER SPECIFICATIONS  
(continued)**

Effluent application	<p>By use of pressure distribution network conforming to sizing methods of either Small Scale Waste Management Project publication 9.6, entitled "Design of Pressure Distribution Networks for Septic Tank – Soil Absorption Systems" or Dept. of Safety and Professional Services publications SBD-10573-P or SBD-10706-P, entitled "Pressure Distribution Component Manual for Private Onsite Wastewater Treatment Systems"</p> <p>Pumping up to a Distribution Box and allowing gravity flow from that box is also acceptable.</p> <p>Gravity distribution is acceptable as well.</p>
Piping Material	Meets requirements of s. SPS 384.30 (2), Wis. Adm. Code for its intended use
Distribution cell aggregate material	GSF products as listed in Table 2b
Number of observation pipes per distribution cell	≥ 2
Location of observation pipes	Observation pipes may be located less than 6 inches from end walls or side walls if specified in state-approved manufacturers' installation instructions.
Box Construction	Box construction shall be made out of an impervious layer with a structurally sound retaining wall surrounding it.
Cover material	Soil that will provide frost protection, prevent erosion and excess precipitation or runoff infiltration and allow air to enter the distribution cell
Grading of surrounding area	Graded to divert surface water around mound system
Limited activities	Unless otherwise specifically allowed in this manual, vehicular traffic, excavation, and soil compaction are prohibited in the basal area and 15 feet down slope of basal area, if there is a restrictive horizon that negatively affects treatment or dispersal
Installation inspection	In accordance with ch. SPS 383, Wis. Adm. Code
Management	In accordance with ch. SPS 383, Wis. Adm. Code and this manual

## II. DEFINITIONS

Definitions not found in this section, are located in ch. SPS 381 of the Wisconsin Administrative Code or the terms use the standard dictionary definition.

- A. "Basal Area" means the effective in situ soil surface area available for infiltration of partially treated effluent from the fill material.
- B. "Deflection of distribution cell" means the ratio between the maximum distance between the down slope edge of a concave distribution cell to the length of a perpendicular line that intersects the furthest points of the contour line along the down slope edge of the distribution cell.
- C. "Distribution cell area" means the area within the mound where the effluent is distributed into the fill material.
- D. "Fill Material" means sand that meets specifications of ASTM Standard C33 for fine aggregate and is used along the sides of and under the distribution cell to provide treatment of effluent.
- E. "Limiting Factor" means high groundwater elevation or bedrock.
- F. "Mound" means an on-site wastewater treatment and dispersal component. The structure contains a distribution cell area surrounded by, and elevated above, the original land surface by suitable fill material. The fill material provides a measurable degree of wastewater treatment and allows effluent dispersal into the natural environment under various soil permeability.
- G. "Original Grade" means that land elevation immediately prior to the construction of the mound system.
- H. "Parallel to surface grade contours on sloping sites" means the mound is on the contour except that a 1% cross slope is allowed along the length of the mound. See Ch. SPS 383 Appendix A-383.44 ORIENTATION (6).
- I. "Permeable Soil" means soil with textural classifications according to the U.S. Department of Agriculture, Natural Resource Conservation Service, classification system of silt loam to gravelly medium sand.
- J. "Slowly Permeable Soil" means soil with textural classifications according to the U.S. Department of Agriculture, Natural Resource Conservation Service, classification system of clay loams and silty clay loams that exhibit a moderate grade of structure; and loams, silt loams, and silts with weak grades of structure; or soils with weak to moderate grades of platy structure.
- K. "Product" means one GSF product, manufactured by Eljen Corporation.
- L. "Unsaturated flow" means liquid flow through a soil media under a negative pressure potential. Liquids containing pathogens and pollutants come in direct contact with soil/fill material microsites, which enhances wastewater treatment by physical, biological, and chemical means.
- M. "Vertical Flow" means the effluent flow path downward through soil or fill material, which involves travel along soil surfaces, or through soil pores.
- N. "Vertical Separation" means the total depth of unsaturated soil that exists between the infiltrative surface of a distribution cell and limiting factor (as by redoximorphic features, groundwater or bedrock).

### III. DESCRIPTION AND PRINCIPLE OF OPERATION

POWTS mound component operation is a two-stage process involving both wastewater treatment and dispersal. Treatment is accomplished predominately by physical and biochemical processes within the product and in situ soil. The physical characteristics of the influent wastewater, influent loading rate, temperature, and the nature of the receiving fill material and in situ soil affect these processes.

Physical entrapment, increased retention time, and conversion of pollutants in the wastewater are important treatment objectives accomplished under unsaturated conditions. Pathogens contained in the wastewater are eventually deactivated through filtering, retention, and absorption by the fill material. In addition, many pollutants are converted to other chemical forms by oxidation processes.

Dispersal is primarily affected by the depth of the unsaturated receiving soils, their hydraulic conductivity, land slope, and the area available for dispersal.

The mound in a box consists of fill material, a distribution cell, cover material and a surrounding impervious wall. Effluent is dispersed into the distribution cell where it flows through the fill material and undergoes biological, chemical and physical treatment and then passes into the underlying soil for further treatment and dispersal to the environment.

Cover material consisting of material that provides erosion protection, a barrier to excess precipitation infiltration, and allows gas exchange. See Figure 3, for a typical mound in a box system.

The in situ soil serves in combination with the fill, as dispersal media for the treated effluent.

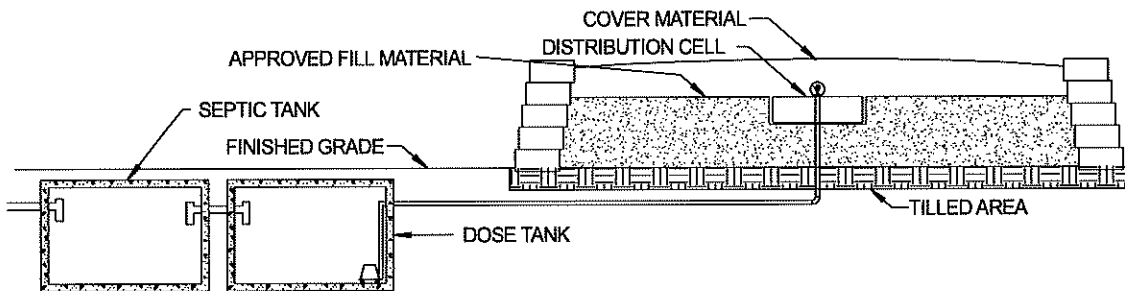

Figure 3. A cross-section of a mound in a box system for POWTS

### IV. SOIL AND SITE REQUIREMENTS

Every GSF mound in a box design is ultimately matched to the given soil and site.

The design approach presented in this manual is based on criteria that all applied wastewater is successfully transported away from the system, that it will not affect subsequent wastewater additions, and that the effluent is ultimately treated.

- A. Minimum Soil Depth Requirements - The minimum soil factors required for successful mound in a box system performance are listed in the introduction and specification section of this package.

Soil evaluations must be in accordance with ch. SPS 385 of the Wis. Adm. Code. In addition, soil application rates must be in accordance with ch. SPS 383 of the Wis. Adm. Code.

B. Other Site Considerations -

1. Slopes - The slope on which a mound is to be installed may not indicate the direction of groundwater movement. If there is documentation that the direction of groundwater movement is different than the slope of the land, the direction of groundwater movement must be considered during mound in a box design.

On a crested site the fill can be situated such that the effluent can move laterally down both slopes. A level site allows lateral flow in all directions, but may present problems as the water table could rise higher beneath the fill in slowly permeable soils. The sloping site allows the liquid to move in one direction away from the fill. Figure 5 shows a cross-section of a mound in a box and the effluent movement in a slowly permeable soil on a sloping site. Systems that are installed on a concave slope may have a deflection that does not exceed that allowed in Table 2.

Mound components rely on lateral effluent movement through the upper soil horizons. Lateral movement becomes more important as soil permeability decreases.

2. Mound in a box location - In open areas, exposure to sun and wind increases the assistance of evaporation and transpiration in the dispersal of the wastewater.
3. Sites with trees and large boulders - Generally, sites with large trees, numerous smaller trees or large boulders are less desirable for installing a mound system because of difficulty in preparing the surface and the reduced infiltration area beneath the mound. Areas that are occupied with rock fragments, tree roots, stumps and boulders reduce the amount of soil available for proper treatment. If no other site is available, trees in the basal area of the mound must be cut off at ground level. A larger fill area is necessary when any of the above conditions are encountered, to provide sufficient infiltrative area.
4. Setback distances - The setbacks specified in ch. SPS 383, Wis. Adm. Code for soil subsurface treatment/dispersal component apply to mound in a box systems. The distances are measured from the inside edges of the box.

V. FILL AND COVER MATERIAL

- A. Fill Material - The fill material and its placement are one of the most important components of the mound system. Quality control of the fill material is critical to system performance, each truckload of material must meet specifications for the fill.

Determining whether a proposed fill material is suitable or not requires that a textural analysis be performed. The standard method to be used for performing this analysis conforms to ASTM C-136, Method for Sieve Analysis of Fine and Coarse Aggregates, and ASTM E-11, Specifications for Wire-Cloth Sieves for Testing Purposes, Annual Book of ASTM Standards, Volume 04.02. Information concerning these methods can also be obtained from Methods of Soils Analysis Part 1, C. A. Black, ed., ASA, Monograph #9, American Society of Agronomy, Inc., 1975.

- B. Cover material - The cover material is a soil that will allow air exchange while promoting plant growth. The gas exchange will increase the treatment performance of the system by providing oxygen to the wastewater to help ensure aerobic conditions in the mound system. The plant growth will provide frost protection in the winter season. Clays may not be used for cover material, as they will restrict oxygen transfer. Often, excavated soil from the site can be used. Seeding or other means must be done to prevent erosion of the mound.

VI. DESIGN

- A. Location, Size and Shape - Placement, sizing and shaping of the mound in a box and the distribution cell within the mound must be in accordance with this manual. The means of dosing the distribution network must provide equal distribution of the wastewater. A pressurized distribution network using a method of sizing as described in either Small Scale Waste Management Project publication 9.6, entitled "Design of Pressure Distribution Networks for Septic Tank – Soil Absorption System" or Dept. of Safety and Professional Services publications SBD-10573-P or SBD-10706-P, entitled "Pressure Distribution Component Manual for Private Onsite Wastewater Treatment Systems" is acceptable. Additionally, gravity distribution is also permitted.
- B. Component Design - Design of the mound in a box system is based upon the design wastewater flow and the soil characteristics. It must be sized such that it can accept the design wastewater flow without causing surface seepage or groundwater pollution. Consequently, the basal area, which is the in situ soil area beneath the fill, must be sufficiently large enough to absorb the effluent into the underlying soil. The system must also be designed to avoid encroachment of the water table into the required minimum unsaturated zone.

Design of the mound in a box includes the following three steps: (A) calculating design wastewater flow, (B) design of the distribution cell within the fill, (C) design of the entire mound. This includes calculating total width, total length, system height, distribution lateral location and observation pipes. Each step is discussed. A design example is provided in section XI of the manual. The letters for the various dimensions correlate with those in Figures 4 and 5.

Step A. Design Wastewater Flow Calculations

One and two-family dwellings. Distribution cell size for one and two-family dwelling application is determined by calculating the design wastewater flow (DWF). To calculate DWF use, Formulas 1, 2 or 3. Formula 1 is for combined wastewater flows, which consist of blackwater, clearwater and graywater. Formula 2 is for only clearwater and graywater. Formula 3 is blackwater only.

Formula 1 Combined wastewater DWF = 150 gal/day/bedroom	Formula 2 Clearwater & Graywater DWF = 90 gal/day/bedroom	Formula 3 Blackwater DWF = 60 gal/day/bedroom
---	---	---

Public Facilities. Distribution cell size for public facilities application is determined by calculating the DWF using Formula 4. Only facilities identified in Table 4 are included in this manual. Estimated daily wastewater flows are determined in accordance with Table 4 or s. SPS 383.43(6), Wis. Adm. Code. Many commercial facilities have high BOD5, TSS and FOG (fats, oils and grease), which must be pretreated in order to bring their values down to an acceptable range before entering into the mound in a box component described in this manual.

Formula 4

$$DWF = \text{Sum of each estimated wastewater flow per source per day} \times 1.5$$

Where 1.5 = Conversion factor to convert estimated wastewater flow to design wastewater flow

**Table 4  
Public Facility Wastewater Flows**

Source	Unit	Estimated Wastewater Flow (gpd)
Apartment or Condominium	Bedroom	100
Assembly hall (no kitchen)	Person (10 sq. ft./person)	1.3
Bar or cocktail lounge (no meals served)	Patron (10 sq. ft./patron)	4
Bar or cocktail lounge* (w/meals – all paper service)	Patron (10 sq. ft./patron)	8
Beauty salon	Station	90
Bowling alley	Bowling lane	80
Bowling alley (with bar)	Bowling lane	150
Camp, day and night	Person	25
Camp, day use only (no meals served)	Person	10
Campground or Camping Resort	Space, with sewer connection and/or service building	30
Campground sanitary dump station	Camping unit or RV served	25
Catch basin	Basin	65
Church (no kitchen)	Person	2
Church* (with kitchen)	Person	5
Dance hall	Person (10 sq. ft./person)	2
Day care facility (no meals prepared)	Child	12
Day care facility* (with meal preparation)	Child	16
Dining hall* (kitchen waste only without dishwasher and/or food waste grinder)	Meal served	2
Dining hall* (toilet and kitchen waste without dishwasher and/or food waste grinder)	Meal served	5
Dining hall* (toilet and kitchen waste with dishwasher and/or food waste grinder)	Meal served	7
Drive-in restaurant* (all paper service with inside seating)	Patron seating space	10
Drive-in restaurant* (all paper service without inside seating)	Vehicle space	10
Drive-in theater	Vehicle space	3
Employees (total all shifts)	Employee	13
Floor drain (not discharging to catch basin)	Drain	25
Gas station / convenience store	Patron (minimum 500 patrons)	3
Gas station (with service bay)		
Patron	Patron	3
Service bay	Service bay	50
Hospital*	Bed space	135
Hotel, motel or tourist rooming house	Room	65
Medical office building		
Doctors, nurses, medical staff	Person	50
Office personnel	Person	13
Patients	Person	6.5
Migrant labor camp (central bathhouse)	Employee	20
Mobile Home (Manufactured home) (served by its own POWTS)	Bedroom	100
Mobile home park	Mobile home site	200

\* = May be high strength waste

Table 4  
Public Facility Wastewater Flows  
(continued)

Source	Unit	Estimated Wastewater Flow (gpd)
Nursing, Rest Home, Community Based Residential Facility	Bed space	65
Outdoor sport facilities (toilet waste only)	Patron	3.5
Parks (toilets waste only)	Patron (75 patrons/acre)	3.5
Parks (toilets and showers)	Patron (75 patrons/acre)	6.5
Public shower facility	Shower taken	10
Restaurant*, 24-hr. (dishwasher and/or food waste grinder only)	Patron seating space	4
Restaurant*, 24-hr. (kitchen waste only without dishwasher and/or food waste grinder)	Patron seating space	12
Restaurant, 24-hr. (toilet waste)	Patron seating space	28
Restaurant*, 24-hr. (toilet and kitchen waste without dishwasher and/or food waste grinder)	Patron seating space	40
Restaurant*, 24-hr. (toilet and kitchen waste with dishwasher and/or food waste grinder)	Patron seating space	44
Restaurant* (dishwasher and/or food waste grinder only)	Patron seating space	2
Restaurant* (kitchen waste only without dishwasher and/or food waste grinder)	Patron seating space	6
Restaurant (toilet waste)	Patron seating space	14
Restaurant* (toilet and kitchen waste without dishwasher and/or food waste grinder)	Patron seating space	20
Restaurant* (toilet and kitchen waste with dishwasher and/or food waste grinder)	Patron seating space	22
Retail store	Patron (70% of total retail area ÷ 30 sq. ft. per patron)	1
School* (with meals and showers)	Classroom (25 students/classroom)	500
School* (with meals or showers)	Classroom (25 students/classroom)	400
School (without meals or showers)	Classroom (25 students/classroom)	300
Self-service laundry (toilet waste only)	Clothes washer	33
Self-service laundry (with only residential clothes washers)	Clothes washer	200
Swimming pool bathhouse	Patron	6.5

\* = May be high strength waste



Step B. Design of the Distribution Cell - This section determines the required infiltrative surface area of the distribution cell/fill interface, as well as the dimensions of the distribution network within the fill.

1. Sizing the Distribution Cell - The minimum bottom area of the distribution cell is determined by dividing the design wastewater flow per day by the design loading rate of the fill material. As specified in Table 1, the design loading rate of the infiltration surface of the distribution cell is:

$$\leq 2.0 \text{ gal/ft}^2/\text{day if BOD}_5 \text{ or TSS} \leq 30 \text{ mg/L}$$

Using the above information, the infiltrative surface area of the distribution cell area is determined by using formulas 5 and 6.

Formula 5

Required # of units = (DWF ÷ design loading rate of the fill material) ÷ square footage of product (shown in Table 2c), round up to nearest whole number.

Notes: The width of the distribution cell must be selected first based on intended product(s) to be installed.

The length of the system = 4 x required # of units ÷ # of Rows + 1

Formula 6

Area = The length of the system x the distribution cell width (shown in Table 2c).

For concave systems the actual distribution cell length must be checked to determine if the cell area is sufficient. See Step B 3 for further information.

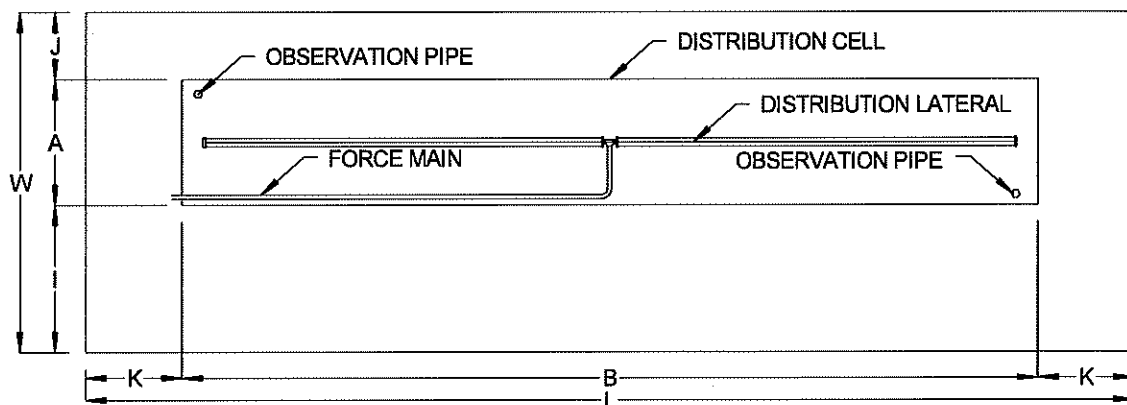

Figure 4. Detailed plan view of a mound in a box

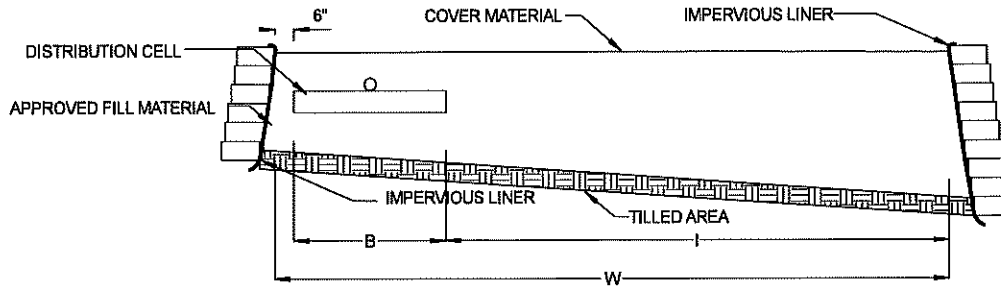

Figure 5. Detailed cross-section of a mound in a box

2. **System Configuration** - The GSF product distribution cell must be longer than it is wide. Maximum width of the distribution cell is 10 feet. The maximum length of the distribution cell is dependent on setback requirements and soil evaluation.

The distribution cell is aligned with its longest dimension parallel to surface grade contours on sloping sites as required by the specifications of this package so as not to concentrate the effluent into a small area as it moves laterally down slope.

The bottom of the distribution cell is level so one area of the distribution cell is not overloaded.

The dimensions for the distribution cell are calculated using Formulas 7 or 8. Formula 7 is used when the in situ soil has a soil application rate of greater than 0.3 gal/ft<sup>2</sup>/day. Formula 8 must be used to check for linear loading rate for the system when the in situ soil within 12 inches of the fill material has a soil application rate of ≤ 0.3 gal/ft<sup>2</sup>/day. When the in situ soil within 12 inches of the fill material has a soil application rate of ≤ 0.3 gal/ft<sup>2</sup>/day the linear loading rate may not exceed 4.5 gal/ft<sup>2</sup>/day.

Formula 7

$$\text{Area of distribution cell} = A \times B.$$

Where: A = Total width products that constitute one laying length of the distribution cell (Distribution Cell width - Max. allowed is 10 ft.)

$$B = (\# \text{ of units}) \times 4 \div \# \text{ of Rows} + 1$$

Formula 8

$$\text{Linear Loading Rate} = \text{DWF} \div B$$

Where: DWF = Design wastewater flow

B = Distribution cell length

3. **Concave Mound Configuration** – The maximum deflection of a concave distribution cell of a mound system is 10%. The percent of deflection of a distribution cell is determined by dividing the amount of deflection by the effective distribution cell length of the concave distribution cell. The deflection is the maximum distance between the down slope edge of a concave distribution cell to the length of a perpendicular line that intersects furthest points of the contour line along the down slope edge of the distribution cell. The effective distribution cell length of the concave distribution cell is the distance between the furthest points along the contour line of the down slope edge of the concave distribution cell. See Figures 6 and 7.

The deflection of a distribution cell on concave slopes is calculated using Formula 9.

Formula 9

Percent of Deflection = (Deflection ÷ Effective distribution cell length) x 100

Where: Deflection = Maximum distance between the down slope edge of a concave distribution cell to the length of a perpendicular line that intersects furthest points of the contour line along the down slope edge of the distribution cell

Effective distribution cell length = Distance between the furthest points along the contour line of the down slope edge of the concave distribution cell

100 = Conversion factor

The actual distribution cell length must be checked to determine if the cell area is sufficient. The actual distribution cell length is calculated using Formula 10.

Formula 10

Actual distribution cell length = [(% of deflection x 0.00265) + 1] x effective distribution cell length

Where: % of deflection = Determined by Formula 9

0.00265 = Conversion factor from percent to feet

1 = Constant

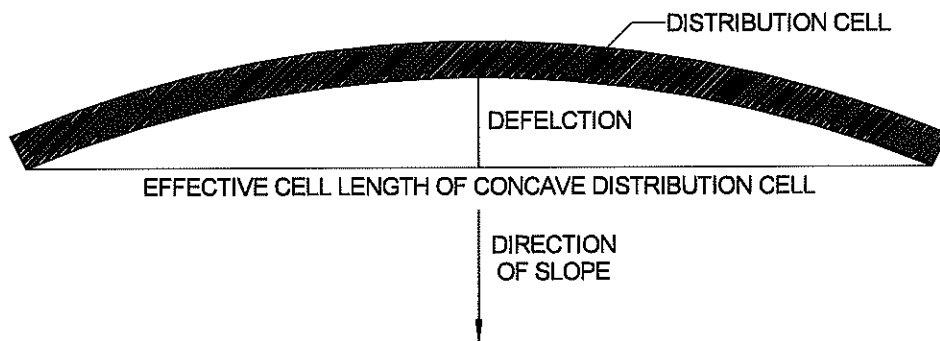

Figure 6. Simple concave distribution cell

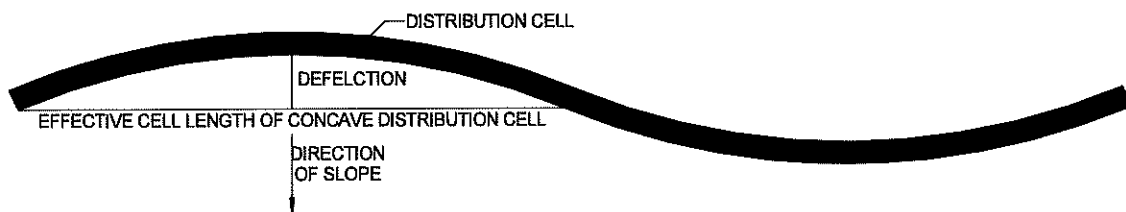

Figure 7. Complex concave distribution cell

Step C. Sizing the Mound

1. **Mound Height** - The mound height on sloping sites is calculated using Formula 11.

Formula 11

$$\text{Mound Height} = (D + E) \div 2 + F + H$$

Where: D = Sand fill depth

E = Down slope fill depth

F = GSF product distribution cell depth

H = Cover material depth

2. **Fill Depth** - The depth of fill under the distribution cell is based on the minimum depth of unsaturated soil required for treatment listed in Table 383.44-3, Wis. Adm. Code. The minimum fill depth is 12 inches, but not greater than 36 inches when the soil listed in Table 383.44-3, Wis. Adm. Code, is 36 inches or less. The minimum fill depth is 12 inches, but not greater than 36 inches when the soil listed in Table 383.44-3, Wis. Adm. Code, is greater than 36 inches. A minimum unsaturated flow depth required for proper treatment of the wastewater is as required by Table 383.44-3, Wis. Adm. Code.

For sloping sites the fill depth below down slope edge of distribution cell (E)  $\geq D + [\% \text{ slope of original grade as a decimal} \times \text{width of distribution cell (A)}]$

3. **Distribution Cell Depth** - The distribution cell depth (F) provides wastewater storage within the distribution cell. For an GSF mound in a box system, the distribution cell depth (F) shall be defined as the height of the product.

Formula 12

$$\text{Distribution cell depth (F)} = 7 \text{ inches}$$

4. **Cover Material** - The cover material (G & H) provides frost protection and a suitable growth medium for vegetation. For design purposes, use a depth of 12 inches above the center of the distribution cell (H) and 6 inches above the outer edge of the distribution cell (G).

Cover material depth at product distribution cell center (H)  $\geq 12$  inches

Cover material depth at product distribution cell edges (G)  $\geq 6$  inches

5. **Fill Length and Width** - The length and width of the fill are dependent upon the length and width of the product, fill depth and side berms of the fill. Side berms are not sloped and stay generally level to the edge of the box.

The fill length consists of the end berms (K) and the distribution cell length (B). The fill width consists of the up slope berm (J), the distribution cell width (A), and the down slope berm (I). To calculate the down slope berm, multiply the calculated width by the correction factor found by using the following equations or the correction factor listed in Table 5.

Down slope berm correction factor =  $100 \div [100 - (3 \times \% \text{ of slope})]$

Table 5 Down slope and up slope width correction factors	
Slope %	Down slope correction factor
0	1.00
1	1.03
2	1.06
3	1.10
4	1.14
5	1.18
6	1.22
7	1.27
8	1.32
9	1.37
10	1.43
11	1.49
12	1.56
13	1.64
14	1.72
15	1.82
16	1.92
17	2.04
18	2.17
19	2.33
20	2.50
21	2.70
22	2.94
23	3.23
24	3.57
25	4.00

The most critical dimensions of the fill are: fill depths (D) & (E), distribution cell length (B), distribution cell width (A), and the down slope berm (I).

End slope berm (K) greater than or equal to 6 inches.

Fill Length (L) = Distribution cell length (B) + 2 x end slope berm (K)

Up slope berm (J) greater than or equal to 6 inches.

Down slope berm (I) = Fill depth at down slope edge of distribution cell (E + F + G) x horizontal gradient of side slope (3 if 3:1) x slope correction factor  $\{100 \div [100 - (3 \times \% \text{ of slope})]$  if 3:1

Fill Width (W) = Up slope berm (J) + down slope berm (I) + width of distribution cell (A)

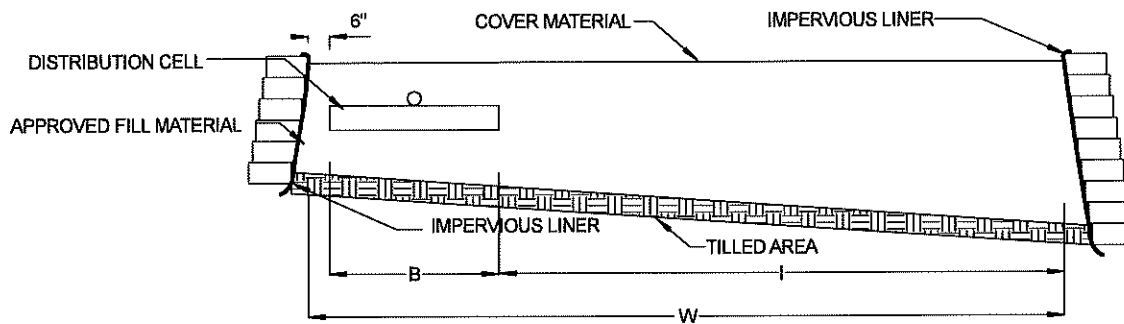

Figure 8. Cross-section of a mound in a box system

6. **Basal Area** - The basal area is the in situ soil/fill interface between the soil and the fill material. Its function is to accept the effluent from the fill, assist the fill in treating the effluent, and transfer the effluent to the subsoil beneath the fill or laterally to the subsoil outside of the fill.

The soil infiltration rate of the in situ soil determines how much basal area is required. The wastewater applied to the mound has values for BOD5 and TSS of  $\leq 30$  mg/L the soil application rates for the basal area may be those specified in Table 383.44-1 or -2 for maximum monthly average BOD5 and TSS of  $\leq 30$  mg/L.

For level sites, the total basal area, excluding end slope berm [length of distribution cell (B) x width of fill and cover (W)] beneath the fill and soil cover is available for effluent absorption into the soil (see Figure 9). For sloping sites, the available basal area is the area down slope of the up slope edge of the distribution cell to the down slope edge of the fill and soil cover or (A + I) times the length of the distribution cell (B) (see Figure 10). The up slope berm and end berm are not included as part of the total basal area.

It is important to compare the required basal area to the available basal area. The available basal area must equal or exceed the required basal area.

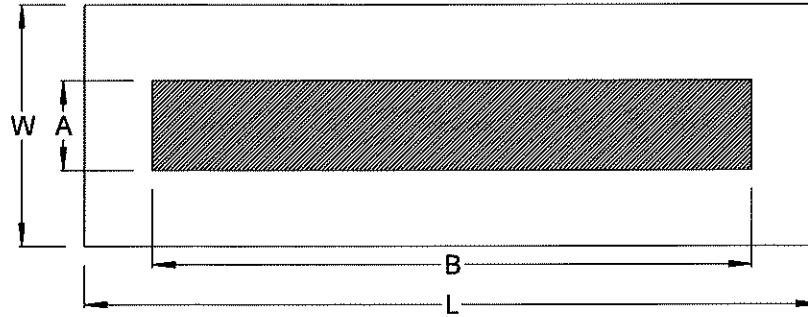

Figure 9. Level site

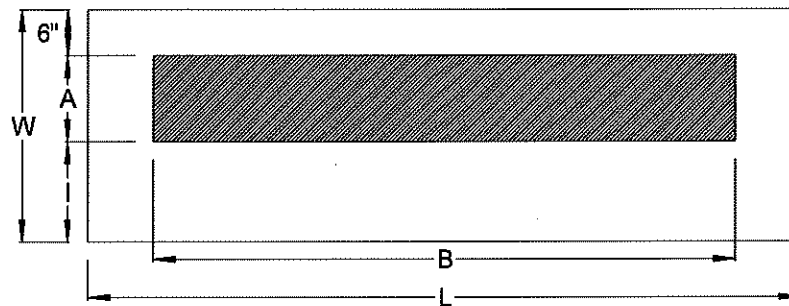

Figure 10. One direction slope

Basal area required =  $DWF \div \text{Infiltration rate of in situ soil}$

Basal area available =  $B \times W$  on a level site or  $= B \times (A+I)$  on a sloping site.

If sufficient area is not available for the given design and site conditions, corrective action is required to increase (J) and (I) on level sites or (I) on sloping sites.

7. Location of the observation pipes.

Observation pipes will be installed in each distribution cell so as to be representative of a cell's hydraulic performance.

- be located such that there are a minimum of two installed in each dispersal cell at opposite ends from one another
- be located near the dispersal cell ends
- be at least 6 inches from the end wall and sidewall
- be installed at an elevation to view the horizontal or level infiltrative surface within the dispersal cell

Observation pipes may be located less than 6 inches from end walls or side walls if specified in state-approved manufacturers' installation instructions

Step D. Distribution Network and Dosing System A pressurized distribution network based on a **method of sizing** as described in either Small Scale Waste Management Project publication 9.6, entitled "Design of Pressure Distribution Networks for Septic Tank – Soil Absorption Systems" or Dept. of Safety and Professional Services publications SBD-10573-P or SBD-10706-P, entitled "Pressure Distribution Component Manual for Private Onsite Wastewater Treatment Systems" is acceptable. The designer is allowed to pump up to an appropriately sized distribution box and use gravity flow from that box. Additionally, gravity distribution is also permitted in gravity dose or pump up to a distribution box and then gravity flow out.

## VII. SITE PREPARATION AND CONSTRUCTION

Procedures used in the construction of a mound in the box system are just as critical as the design of the system. A good design with poor construction results in system failure. It is emphasized that the soil only be tilled when it is not frozen and the moisture content is low to avoid compaction and puddling. The construction plan to be followed includes:

A. Equipment - Proper equipment is essential. Track type equipment that will not compact the mound area or the down slope area is required.

B. Sanitary Permit - Prior to the construction of the system, a sanitary permit, obtained for the installation must be posted in a clearly visible location on the site. Arrangements for inspection(s) must also be made with the department or governmental unit issuing the sanitary permit.

### C. Construction Procedures

1. Check the moisture content of the soil to a depth of 8 inches. Smearing and compacting of wet soil will result in reducing the infiltration capacity of the soil. Proper soil moisture content can be determined by rolling a soil sample between the hands. If it rolls into a 1/4- inch wire, the site is too wet to prepare. If it crumbles, site preparation can proceed. If the site is too wet to prepare, do not proceed until it dries.
2. Lay out the fill area on the site so that the distribution cell runs perpendicular to the direction of the slope.
3. Establish the original grade elevation (surface contour) along the up slope support wall of the distribution cell. This elevation is used throughout the mound in a box construction as a reference to determine the bottom of the distribution cell, lateral elevations, etc., and is referenced to the permanent bench mark for the project. A maximum of 4 inches of sand fill may be tilled into the surface.
4. Cut trees flush to the ground and leave stumps, remove surface boulders that can be easily rolled off, remove vegetation over 6 inches long by mowing and removing cut vegetation. Prepare the site by breaking up, perpendicular to the slope, the top 7-8 inches so as to eliminate any surface mat that could impede the vertical flow of liquid into the in situ soil. When using a moldboard plow, it should have as many bottoms as possible to reduce the number of passes over the area to be tilled and minimize compaction of the subsoil. Tilling with a moldboard plow is done along contours. Chisel type plowing is highly recommended especially in fine textured soils. Rototilling or other means that pulverize the soil is not acceptable. The important point is that a rough, unsmear surface be left. The sand fill will intermingle between the clods of soil, which improves the infiltration rate into the natural soil.



5. Determine where the force main from the dosing chamber will connect to the distribution system in the distribution cell. Place the pipe either before tilling or after placement of the fill. If the force main is to be installed in the down slope area, the trench for the force main may not be wider than 12 inches.
6. Build the outside support structure and line with an impervious barrier. Ensure that the bottom of the cell is left open to the receiving soil.
7. Immediate application of at least 6 inches of fill material is required after tilling. All vehicular traffic is prohibited on the tilled area. For sites where the effluent may move laterally, vehicle traffic is also prohibited for 15 ft. down slope and 10 ft. on both sides of level sites. If it rains after the tilling is completed, wait until the soil dries out before continuing construction, and contact the local inspector for a determination on the damage done by rainfall.
8. Place the approved sand fill material, throughout the tilled area. Work from the end and up slope sides. This will avoid compacting the soils on the down slope side, which, if compacted, affects lateral movement away from the fill and could cause surface seepage at the toe of the fill on slowly permeable soils.
9. Move the fill material into place using a small track type tractor with a blade or a large backhoe that has sufficient reach to prevent compaction of the tilled area. Do not use a tractor/backhoe having tires. Always keep a minimum of 6 inches of fill material beneath tracks to prevent compaction of the in situ soil.
10. Place the fill material to the required depth.
11. Form the distribution cell. Hand level the bottom of the distribution cell.
12. Install the GSF products and distribution piping per instructions. If using pressure distribution, distribution pipe should be sleeved through the 4-inch corrugated pipe located in the GSF product. One out of every five orifices in each distribution pipe shall be installed at the 6 o'clock position so as to allow for thorough drainage of the distribution pipe following each dose. The remaining four orifices shall be installed in the 12 o'clock position. All pipes must drain after dosing. The designer is allowed to pump up to an appropriately sized distribution box and use gravity flow from that box.
12. If using pressure, at the end of the lateral, place a 90° long sweep with a capped piece of pipe pointing up through the soil surface. Cover the capped pipe with a valve box and lid of an adequate size. The cover of the valve box shall be located above the final grade of the mound (Figure 11). Not required if a pump to gravity application is in use.
13. Install an observation pipe in each row of GSF products with the bottom 19 inches of the observation pipe slotted. Installations of all observation pipes include a suitable means of anchoring (Figure 11).

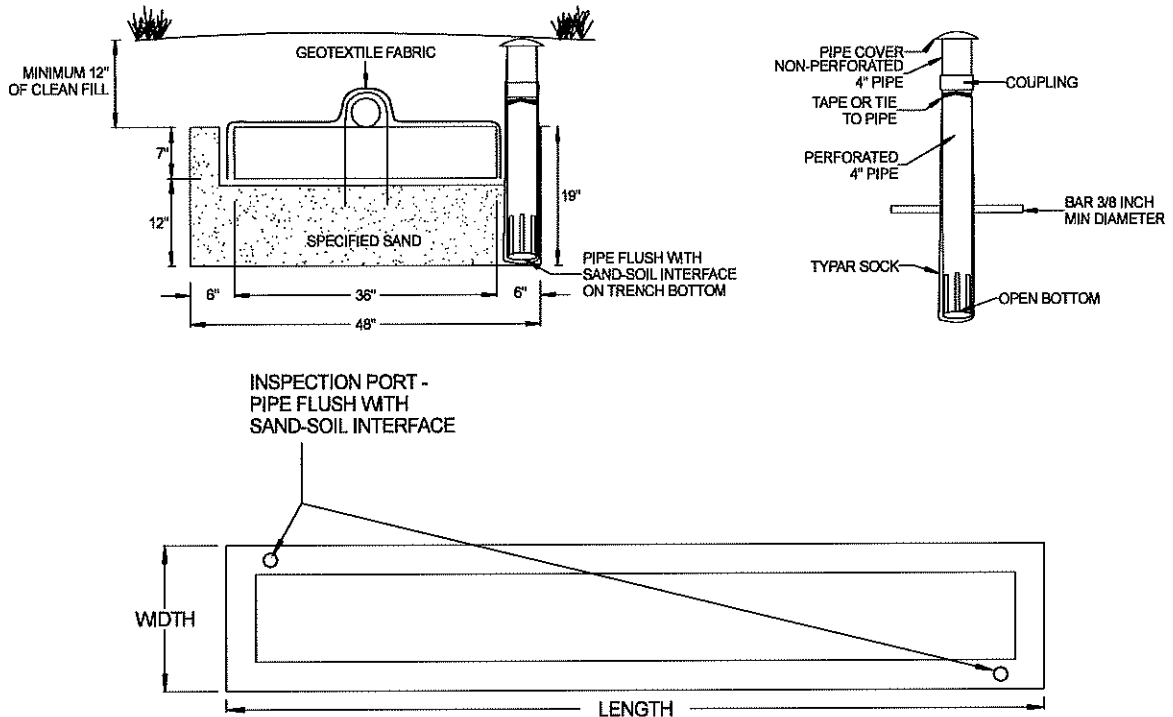

Figure 11

14. Place approved barrier cover, conforming to requirements of ch. SPS 384, Wis. Adm. Code or otherwise approved by the Dept. of Safety and Professional Services, over the product rows, cover barrier cover with cover material, and extend the soil cover to the boundaries of the overall component. Be sure to keep the required 6-inch minimum compacted cover over the system.

15. Complete final grading to divert surface water drainage away from mound in a box.

#### VIII. OPERATION, MAINTENANCE AND PERFORMANCE MONITORING

- A. The component owner is responsible for the operation and maintenance of the component. The county, department or POWTS service contractor may make periodic inspections of the components, checking for surface discharge, treated effluent levels, etc.

The owner or owner's agent is required to submit necessary maintenance reports to the appropriate jurisdiction and/or the department.

- B. Design approval and site inspections before, during, and after the construction are accomplished by the county or other appropriate jurisdictions in accordance to ch. SPS 383 of the Wis. Adm. Code.

- C. Routine and preventative maintenance aspects:

1. Septic and distribution tanks are to be inspected routinely and maintained when necessary in accordance with their approvals.

2. Inspections of the mound in a box component performance are required at least once every three years. These inspections include checking the liquid levels in the observation pipes and examination for any seepage around the mound in a box component.
  3. A good water conservation plan within the house or establishment will help assure that the mound in a box component will not be overloaded.
- D. User's Manual: A user's manual is to accompany the component. The manual is to contain the following as a minimum:
1. Diagrams of all components and their location. This should include the location of the reserve area, if one is provided.
  2. Names and phone numbers of local health authority, component manufacturer or POWTS service contractor to be contacted in the event of component failure or malfunction.
  3. Information on periodic maintenance of the component, including electrical/mechanical components.
  4. Information on limited activities on reserve area if provided.
- E. Performance monitoring must be performed on mound in a box systems installed under this manual.
1. The frequency of monitoring must be:
    - a. At least once every three years following installation and,
    - b. At time of problem, complaint, or failure.
  2. The minimum criteria addressed in performance monitoring of mound in a box systems are:
    - a. Type of use.
    - b. Age of system.
    - c. Nuisance factors, such as odors or user complaints.
    - d. Mechanical malfunction within the system including problems with valves or other mechanical or plumbing components.
    - e. Material fatigue or failure, including durability or corrosion as related to construction or structural design.
    - f. Neglect or improper use, such as exceeding the design rate, poor maintenance of vegetative cover, inappropriate cover over the mound, or inappropriate activity over the mound.
    - g. Installation problems such as compaction or displacement of soil, improper orientation or location.
    - h. Pretreatment component maintenance, including dosing frequency, structural integrity, groundwater intrusion or improper sizing.
    - i. Dose chamber maintenance, including improper maintenance, infiltration, structural problems, or improper sizing.
    - j. Distribution piping network, including improper maintenance or improper sizing.
    - k. Ponding in distribution cell, prior to the pump cycle, is evidence of development of a clogging mat or reduced infiltration rates.
    - l. Siphon or pump malfunction including dosing volume problems, pressurization problems, breakdown, burnout, or cycling problems.

m. Overflow/seepage problems, as shown by evident or confirmed sewage effluent, including backup if due to clogging.

3. Reports are to be submitted in accordance with ch. SPS 383, Wis. Adm. Code.

#### IX. REFERENCES

"Wisconsin Mound Soil Absorption System: Siting, Design and Construction." Converse, J.C., and E. J. Tyler. Publication 15.22, Small Scale Waste Management Project., 1 Agriculture Hall, University of Wisconsin, Madison, WI.

"Mound Component Manual for Private Onsite Wastewater Treatment Systems." State of Wisconsin Department of Safety and Professional Services Division of Safety and Buildings. Version 2.0, January 30, 2001.

XI. EXAMPLE GSF MOUND IN A BOX WORKSHEET

A. SITE CONDITIONS

Evaluate the site and soils report for the following:

- Surface water movement.
- Measure elevations and distances on the site so that slope, contours and available areas can be determined.
- Description of several soil profiles where the component will be located.
- Determine the limiting conditions such as bedrock, high groundwater level, soil permeability, and setbacks.

Slope - \_\_\_\_%

Occupancy – One or Two-Family Dwelling - \_\_\_\_\_ (# of bedrooms)

Public Facility - \_\_\_\_\_ gal/day (Estimated wastewater flow)

Depth to limiting factor - \_\_\_\_\_ inches

Minimum depth of unsaturated soil required by Table 383.44-3, Wis. Adm. Code - \_\_\_\_\_ inches

In situ soil application rate used - \_\_\_\_\_ gal/ft<sup>2</sup>/day

FOG value of effluent applied to component - \_\_\_\_\_ mg/L

Treated Effluent from Component

BOD<sub>5</sub> value of effluent leaving the component - ≤ 30 TSS mg/L

TSS value of effluent leaving the component - ≤ 30 mg/L

Fecal Coliform monthly geometric mean value of effluent applied to component > 10<sup>4</sup> cfu/100ml X No

Product(s) to be installed in the distribution cell - \_\_\_ A42 \_\_\_ B43

Table 2c APPROVED PRODUCT INSTALLATIONS AND SQUARE FOOTAGE				
Product	Square Footage	Installation Width	Installation Length	Install Height
A42	square feet per unit	36"	48"	19"
	16 square feet per unit	48"	48"	19"
	20 square feet per unit	60"	48"	19"
B43	16 square feet per unit	48"	48"	19"
	20 square feet per unit	60"	48"	19"
	24 square feet per unit	72"	48"	19"

B. DESIGN WASTEWATER FLOW (DWF)

One or Two-family Dwelling.

Combined wastewater flow:

$$\begin{aligned} \text{DWF} &= 150 \text{ gal/day/bedroom} \times \# \text{ of bedrooms} \\ &= 150 \text{ gal/day/bedroom} \times \text{ \_\_\_\_\_\_ } \# \text{ of bedrooms} \\ &= \text{ \_\_\_\_\_\_ } \text{ gal/day} \end{aligned}$$

Clearwater and graywater only:

$$\begin{aligned} \text{DWF} &= 90 \text{ gal/day/bedroom} \times \# \text{ of bedrooms} \\ &= 90 \text{ gal/day/bedroom} \times \text{ \_\_\_\_\_\_ } \# \text{ of bedrooms} \\ &= \text{ \_\_\_\_\_\_ } \text{ gal/day} \end{aligned}$$

Blackwater only:

$$\begin{aligned} \text{DWF} &= 60 \text{ gal/day/bedroom} \times \# \text{ of bedrooms} \\ &= 60 \text{ gal/day/bedroom} \times \text{ \_\_\_\_\_\_ } \# \text{ of bedrooms} \\ &= \text{ \_\_\_\_\_\_ } \text{ gal/day} \end{aligned}$$

Public Facilities.

$$\begin{aligned} \text{DWF} &= \text{Estimated wastewater flow} \times 1.5 \\ &= \text{ \_\_\_\_\_\_ } \text{ gal/day} \times 1.5 \\ &= \text{ \_\_\_\_\_\_ } \text{ gal/day} \end{aligned}$$

C. DESIGN OF THE GSF SECTION DISTRIBUTION CELL

1. Total size of the Distribution cell(s) area

a. Loading rate of fill material (LLR) =  $\text{ \_\_\_\_\_\_ } \leq 2.0 \text{ gal/ft}^2/\text{day}$  if BOD<sub>5</sub> or TSS  $\leq 30 \text{ mg/L}$

b. Required # of units =  $\text{DWF} \div 2.0 \text{ gal/ft}^2/\text{day} \div \text{Product square footage}$

(note: If the answer is not a whole number, round up to the next whole number.)

Required # of 4 ft. product increments =  $\text{ \_\_\_\_\_\_ } \text{ gal/day} \div 2.0 \text{ gal/ft}^2/\text{day} \div \text{ \_\_\_\_\_\_ } \text{ ft}^2 \div \text{ \_\_\_\_\_\_ } \text{ row(s)} = \text{ \_\_\_\_\_\_ }$ , Round up to  $\text{ \_\_\_\_\_\_ }$  for  $\text{ \_\_\_\_\_\_ }$  equal row(s) of  $\text{ \_\_\_\_\_\_ }$ .

Note: The minimum number of A42 units is 6 per bedroom or 5 B43s per bedroom.

c. Area =  $\text{ \_\_\_\_\_\_ }$  (Minimum number of 4 ft. product increments determined in b. above)  $\times 4 \times \text{Product width}$

Area =  $\text{ \_\_\_\_\_\_ } \times 4 \times \text{ \_\_\_\_\_\_ } \text{ ft} = \text{ \_\_\_\_\_\_ } \text{ ft}^2$

## 2. Distribution cell Configuration

- a. Distribution cell width(s) (A) = \_\_\_\_\_ ft ( $\leq 10$  ft = width of product(s) to be installed.  
Product width is shown in Table 2b)
- b. Distribution cell length (B) = area of distribution cell  $\div$  distribution cell width  
B = \_\_\_\_\_ ft<sup>2</sup>  $\div$  \_\_\_\_\_ = \_\_\_\_\_ ft.

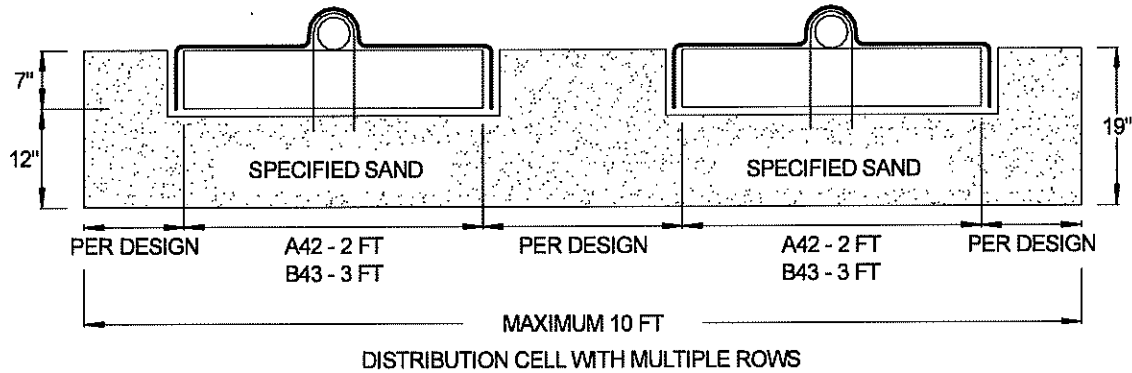

Figure 12. Distribution Cell with Multiple Rows

c. Check distribution cell length (B)

For linear loading rate:

Linear Loading Rate  $\leq$  DWF  $\div$  Cell length (B) or effective cell length for a concave mound)

Linear Loading Rate  $\leq$  \_\_\_\_\_ gal/day  $\div$  \_\_\_\_\_ ft

Linear Loading Rate  $\leq$  \_\_\_\_\_ gal/ft

Linear loading rate for systems with in situ soils having a soil application rate of  $\leq$  0.3 ga/ft<sup>2</sup>/day within 12 inches of fill must be less  $\leq$  4.5 gal/ft/day.

Is the linear loading rate  $\leq$  what is allowed? \_\_\_\_\_ yes \_\_\_\_\_ no If no, then the length and/or width of the distribution cell must be changed so it does.

d. Check percent of deflection and actual length of concave distribution cell length

Percent of deflection = Deflection  $\div$  Effective distribution cell length x 100

Percent of deflection = \_\_\_\_\_ ft  $\div$  \_\_\_\_\_ ft x 100

Percent of deflection = \_\_\_\_\_ % ( $\leq$  10%)

Actual distribution cell length = [(% of deflection x 0.00265) + 1] x effective distribution cell length

Actual distribution cell length = [(\_\_\_\_\_ % x 0.00265) + 1] x \_\_\_\_\_ ft

Actual distribution cell length = \_\_\_\_\_ ft

D. DESIGN OF ENTIRE GSF PRODUCT MOUND IN A BOX AREA

Fill Depth

- a. Minimum fill depth below distribution cell at least 12 inches, but not greater than 36 inches if the in situ soil beneath the tilled area is a soil listed in Table 383.44-3, Wis. Adm. Code, that requires a minimum depth of 36 inches or less. At least 12 inches, but not greater than 36 inches if the in situ soil beneath the tilled area is a soil listed in Table 383.44-3, Wis. Adm. Code, that requires a depth greater than 36 inches.

1) Depth at up slope edge of distribution cell (D) = distance required by Table 383.44-3, Wis. Adm. Code, minus distance in inches to limiting factor

D = \_\_\_\_\_ inches - \_\_\_\_\_ inches

D = \_\_\_\_\_ inches (at least 12 inches, but not greater than 36 inches in accordance with Table 2)

2) Depth at down slope edge of distribution cell (E)

E = Depth at up slope edge of distribution cell (D) + (% natural slope expressed as a decimal x distribution cell width (A))

E = \_\_\_\_\_ inches + (\_\_\_\_\_ x \_\_\_\_\_ feet x 12 inches/ft)



E = \_\_\_\_\_ or \_\_\_\_\_ inches

- b. Distribution cell depth for GSF product distribution cell.

Distribution cell depth (F) for unit distribution cell = Height of tallest product as shown in Table 2b

\_\_\_\_\_ unit height = \_\_\_\_\_ inches

F = \_\_\_\_\_ inches

- c. Cover material

1) Depth at distribution cell center (H) ≥ 12 inches

2) Depth at distribution cell edges (G) ≥ 6 inches

2. Mound in a box length

- a. End cell berm (K) ≥ 6 inches

- b. Mound in a box length (L) = Distribution cell length + (2 x end cell berm)

$$L = B + 2K$$

$$L = \text{_____ ft} + (2 \times \text{_____ ft})$$

$$L = \text{_____ feet}$$

3. Mound in a box width

- a. Up slope berm (J) ≥ 6 inches

- b. Down slope berm (I) = Fill depth at down slope edge of distribution cell (E + F + G) x Horizontal gradient of side slope x Down slope correction factor {100 ÷ [100 - (gradient of side slope x % of slope or value from Table 5)]}

$$I = (E + F + G) \times \text{Horizontal gradient of side slope} \times \text{Down slope correction factor} \{100 \div [100 - (\text{gradient of side slope} \times \% \text{ of slope or value from Table 5})]\}$$

$$I = (\text{_____ in} + \text{_____ in} + \text{_____ in}) \div 12 \text{ in/ft} \times 3 \times 100 \div [100 - (\text{_____} \times \text{_____}) \text{ or } (\text{_____})]$$

$$I = \text{_____ in} \div 12 \text{ in/ft} \times 3 \times 100 \div \text{_____}$$

$$I = \text{_____ or _____ feet}$$

- c. Mound in a box width (W) = Up slope berm (J) + Distribution cell width (A) + Down slope berm (I)

$$W = J + A + I$$

$$W = \text{_____ ft} + \text{_____ ft} + \text{_____ ft}$$

$$W = \text{_____ feet}$$

4. Check the basal area

- a. Basal area required = Daily wastewater flow ÷ soil application rate of in situ soil (The soil application rate may be that which is listed for BOD5 and TSS > or ≤ 30 mg/L depending on wastewater characteristics or fill depth below distribution cell. See Table 1.)

$$\begin{aligned} \text{Basal area required} &= \text{_____ gal/day} \div \text{_____ gal/ft}^2/\text{day} \\ &= \text{_____ ft}^2 \end{aligned}$$

b. Basal area available

- 1) Sloping site = Cell length (B) x [(# of cells x cell width) + {(# of cells - 1) x cell spacing} + down slope berm] (I)

$$\begin{aligned} \text{Basal area available} &= \text{_____ ft} \times [(\text{_____} \times \text{_____ ft}) + \{(\text{_____} - 1) \times 0 \text{ ft}\} + \text{_____ ft}] \\ &= \text{_____ ft} \times (\text{_____ ft} + \text{_____ ft} + \text{_____ ft}) \\ &= \text{_____ ft} \times \text{_____ ft} \\ &= \text{_____ ft}^2 \end{aligned}$$

- 2) Level site = Cell length (B) x total mound in a box width (W)

$$\begin{aligned} \text{Basal area available} &= \text{_____ ft} \times \text{_____ ft} \\ &= \text{_____ ft}^2 \end{aligned}$$

- c. Is available basal area sufficient? \_\_\_\_\_ yes \_\_\_\_\_ no

$$\begin{aligned} \text{Basal area required} &< \text{Basal area available} \\ \text{_____ ft}^2 &\leq \text{_____ ft}^2 \end{aligned}$$

The available basal area must be increased by \_\_\_\_\_ ft<sup>2</sup>. This can be accomplished by increasing the down slope berm (I) by \_\_\_\_\_ ft. making it \_\_\_\_\_ ft.

See d. for recalculation of basal area.

d. Basal area available (recalculation of basal area)

- 1) Sloping site = Cell length (B) x [(# of cells x cell width) + {(# of cells - 1) x cell spacing} + down slope berm] (A+I)

$$\begin{aligned} &= \text{_____ ft} \times [(\text{_____} \times \text{_____ ft}) + \{(\text{_____} - 1) \times 0 \text{ ft}\} + \text{_____ ft}] \\ &= \text{_____ ft} \times (\text{_____ ft} + \text{_____ ft} + \text{_____ ft}) \\ &= \text{_____ ft} \times \text{_____ ft} \\ &= \text{_____ ft}^2 \end{aligned}$$

- 2) Level site = Cell length (B) x total mound in a box width (W)

$$\begin{aligned} &= \text{_____ ft} \times \text{_____ ft} \\ &= \text{_____ ft}^2 \end{aligned}$$

5. Determine the location of observation pipes along the length of distribution cell.

Observation pipes will be installed in each distribution cell so as to be representative of a cell's hydraulic performance.

- be located such that there are a minimum of two installed in the GSF dispersal cell
- be located near the dispersal cell ends
- be at least 6 inches from the end wall and sidewall
- be installed at an elevation to view the horizontal or level infiltrative surface within the dispersal cell
- Observation pipes may be located less than 6 inches from end walls or side walls if specified in state-approved manufacturers' installation instructions.

XI. EXAMPLE GSF MOUND IN A BOX WORKSHEET

A. SITE CONDITIONS

Evaluate the site and soils report for the following:

- Surface water movement.
- Measure elevations and distances on the site so that slope, contours and available areas can be determined.
- Description of several soil profiles where the component will be located.
- Determine the limiting conditions such as bedrock, high groundwater level, soil permeability, and setbacks.

Slope - 6 %

Occupancy – One or Two-Family Dwelling - 3 (# of bedrooms)

Public Facility - 0 gal/day (Estimated wastewater flow)

Depth to limiting factor - 24 inches

Minimum depth of unsaturated soil required by Table 383.44-3, Wis. Adm. Code - 36 inches

In situ soil application rate used - 0.5 gal/ft<sup>2</sup>/day

FOG value of effluent applied to component - < 30 mg/L

Treated Effluent from Component

BOD<sub>5</sub> value of effluent leaving the component - ≤ 30 TSS mg/L

TSS value of effluent leaving the component - ≤ 30 mg/L

Fecal Coliform monthly geometric mean value of effluent applied to component > 10<sup>4</sup> cfu/100ml X No

Product(s) to be installed in the distribution cell - X A42    B43

Table 2c APPROVED PRODUCT INSTALLATIONS AND SQUARE FOOTAGE				
Product	Square Footage	Installation Width	Installation Length	Install Height
A42	12 square feet per unit	36"	48"	19"
	16 square feet per unit	48"	48"	19"
	20 square feet per unit	60"	48"	19"
B43	16 square feet per unit	48"	48"	19"
	20 square feet per unit	60"	48"	19"
	24 square feet per unit	72"	48"	19"

B. DESIGN WASTEWATER FLOW (DWF)

One or Two-family Dwelling.

Combined wastewater flow:

$$\begin{aligned} \text{DWF} &= 150 \text{ gal/day/bedroom} \times \text{\# of bedrooms} \\ &= 150 \text{ gal/day/bedroom} \times \underline{3} \text{ \# of bedrooms} \\ &= \underline{450} \text{ gal/day} \end{aligned}$$

Clearwater and graywater only:

$$\begin{aligned} \text{DWF} &= 90 \text{ gal/day/bedroom} \times \text{\# of bedrooms} \\ &= 90 \text{ gal/day/bedroom} \times \underline{\hspace{2cm}} \text{ \# of bedrooms} \\ &= \underline{\hspace{2cm}} \text{ gal/day} \end{aligned}$$

Blackwater only:

$$\begin{aligned} \text{DWF} &= 60 \text{ gal/day/bedroom} \times \text{\# of bedrooms} \\ &= 60 \text{ gal/day/bedroom} \times \underline{\hspace{2cm}} \text{ \# of bedrooms} \\ &= \underline{\hspace{2cm}} \text{ gal/day} \end{aligned}$$

Public Facilities.

$$\begin{aligned} \text{DWF} &= \text{Estimated wastewater flow} \times 1.5 \\ &= \underline{\hspace{2cm}} \text{ gal/day} \times 1.5 \\ &= \underline{\hspace{2cm}} \text{ gal/day} \end{aligned}$$

C. DESIGN OF THE GSF SECTION DISTRIBUTION CELL

2. Total size of the Distribution cell(s) area

a. Loading rate of fill material (LLR) =  $\underline{X} \leq 2.0 \text{ gal/ft}^2/\text{day}$  if BOD<sub>5</sub> or TSS  $\leq 30 \text{ mg/L}$

b. Required # of units =  $\text{DWF} \div 2.0 \text{ gal/ft}^2/\text{day} \div \text{Product square footage}$

(note: If the answer is not a whole number, round up to the next whole number.)

Required # of 4 ft. product increments =  $\underline{450} \text{ gal/day} \div 2.0 \text{ gal/ft}^2/\text{day} \div \underline{12} \text{ ft}^2 \div \underline{1} \text{ row(s)} = \underline{18.75}$ , Round up to 19 for 1 equal row(s) of 19.

Note: The minimum number of A42 units is 6 per bedroom or 5 B43s per bedroom.

c. Area = 19 (Minimum number of 4 ft. product increments determined in b. above) x 4 x Product width

Area = 19 x 4 x 3 ft = 228 ft<sup>2</sup>

2. Distribution cell Configuration

a. Distribution cell width(s) (A) = 3 ft ( $\leq 10$  ft = width of product(s) to be installed.  
Product width is shown in Table 2b)

b. Distribution cell length (B) = area of distribution cell  $\div$  distribution cell width

$$B = \underline{228} \text{ ft}^2 \div \underline{3} + 1 = \underline{77} \text{ ft.}$$

c. Check distribution cell length (B)

For linear loading rate:

Linear Loading Rate  $\leq$  DWF  $\div$  Cell length (B) or effective cell length for a concave mound)

Linear Loading Rate  $\leq$  450 gal/day  $\div$  77 ft

Linear Loading Rate  $\leq$  5.84 gal/ft

Linear loading rate for systems with in situ soils having a soil application rate of  $\leq$  0.3 ga/ft<sup>2</sup>/day within 12 inches of fill must be less  $\leq$  4.5 gal/ft/day.

Is the linear loading rate  $\leq$  what is allowed? X yes \_\_\_\_\_ no If no, then the length and/or width of the distribution cell must be changed so it does.

d. Check percent of deflection and actual length of concave distribution cell length

Percent of deflection = Deflection  $\div$  Effective distribution cell length x 100

Percent of deflection = \_\_\_\_\_ ft  $\div$  \_\_\_\_\_ ft x 100

Percent of deflection = \_\_\_\_\_ % ( $\leq$  10%)

Actual distribution cell length = [(% of deflection x 0.00265) + 1] x effective distribution cell length

Actual distribution cell length = [(      % x 0.00265) + 1] x \_\_\_\_\_ ft

Actual distribution cell length = \_\_\_\_\_ ft

D. DESIGN OF ENTIRE GSF PRODUCT MOUND IN A BOX AREA

Fill Depth

- a. Minimum fill depth below distribution cell at least 12 inches, but not greater than 36 inches if the in situ soil beneath the tilled area is a soil listed in Table 383.44-3, Wis. Adm. Code, that requires a minimum depth of 36 inches or less. At least 12 inches, but not greater than 36 inches if the in situ soil beneath the tilled area is a soil listed in Table 383.44-3, Wis. Adm. Code, that requires a depth greater than 36 inches.

1) Depth at up slope edge of distribution cell (D) = distance required by Table 383.44-3, Wis. Adm. Code, minus distance in inches to limiting factor

D = 36 inches - 24 inches

D = 12 inches (at least  $\geq$  6 or 12 inches, but not greater than 36 inches in accordance with Table 2)

2) Depth at down slope edge of distribution cell (E)

E = Depth at up slope edge of distribution cell (D) + (% natural slope expressed as a decimal x distribution cell width (A))

E = 12 inches + (0.06 x 3 feet x 12 inches/ft)

E = 12.18 or 12.2 inches

- b. Distribution cell depth for GSF product distribution cell.

Distribution cell depth (F) for unit distribution cell = Height of tallest product as shown in Table 2b

A42 unit height = 7 inches

F = 7 inches

- c. Cover material

1) Depth at distribution cell center (H) ≥ 12 inches

2) Depth at distribution cell edges (G) ≥ 6 inches

2. Mound in a box length

a. End cell berm (K) ≥ 6 inches

b. Mound in a box length (L) = Distribution cell length + (2 x end cell berm)

L = B + 2K

L = 77 ft + (2 x 0.5 ft)

L = 78 feet

3. Mound in a box width

a. Up slope berm (J) ≥ 6 inches

b. Down slope berm (I) = Fill depth at down slope edge of distribution cell (E + F + G) x Horizontal gradient of side slope x Down slope correction factor {100 ÷ [100 - (gradient of side slope x % of slope or value from Table 5)]}

$$I = (E + F + G) \times \text{Horizontal gradient of side slope} \times \text{Down slope correction factor} \{100 \div [100 - (\text{gradient of side slope} \times \% \text{ of slope or value from Table 5})]\}$$

$$I = ( \underline{12.2} \text{ in} + \underline{7} \text{ in} + \underline{6} \text{ in} ) \div 12 \text{ in/ft} \times 3 \times 100 \div [100 - ( \underline{3} \times \underline{6} ) \text{ or } ( \underline{0.85} )]$$

$$I = \underline{25.2} \text{ in} \div 12 \text{ in/ft} \times 3 \times 100 \div \underline{82}$$

$$I = \underline{7.68} \text{ or } \underline{8} \text{ feet}$$

b. Mound in a box width (W) = Up slope berm (J) + Distribution cell width (A) + Down slope berm (I)

W = J + A + I

W = 1 ft + 3 ft + 8 ft

W = 12 feet

4. Check the basal area

a. Basal area required = Daily wastewater flow ÷ soil application rate of in situ soil (The soil application rate may be that which is listed for BOD5 and TSS > or ≤ 30 mg/L depending on wastewater characteristics or fill depth below distribution cell. See Table 1.)

Basal area required = 450 gal/day ÷ 0.5 gal/ft<sup>2</sup>/day



$$= \underline{900} \text{ ft}^2$$

b. Basal area available

- 1) Sloping site = Cell length (B) x [(# of cells x cell width) + ((# of cells – 1) x cell spacing) + down slope berm] (I)

$$\begin{aligned} \text{Basal area available} &= \underline{77} \text{ ft} \times [(\underline{1} \times \underline{3} \text{ ft}) + \{(\underline{1} - 1) \times 0 \text{ ft}\} + \underline{8} \text{ ft}] \\ &= \underline{77} \text{ ft} \times (\underline{3} \text{ ft} + \underline{0} \text{ ft} + \underline{8} \text{ ft}) \\ &= \underline{77} \text{ ft} \times \underline{11} \text{ ft} \\ &= \underline{847} \text{ ft}^2 \end{aligned}$$

- 2) Level site = Cell length (B) x total mound in a box width (W)

$$\begin{aligned} \text{Basal area available} &= \underline{\quad} \text{ ft} \times \underline{\quad} \text{ ft} \\ &= \underline{\quad} \text{ ft}^2 \end{aligned}$$

- c. Is available basal area sufficient?  yes  no

Basal area required < Basal area available

$$\underline{900} \text{ ft}^2 \leq \underline{847} \text{ ft}^2$$

The available basal area must be increased by 53 ft<sup>2</sup>. This can be accomplished by increasing the down slope berm (I) by 1 ft. making it 9 ft.

See d. for recalculation of basal area.

c. Basal area available (recalculation of basal area)

- 1) Sloping site = Cell length (B) x [(# of cells x cell width) + ((# of cells – 1) x cell spacing) + down slope berm] (A+I)

$$\begin{aligned} &= \underline{77} \text{ ft} \times [(\underline{1} \times \underline{3} \text{ ft}) + \{(\underline{1} - 1) \times 0 \text{ ft}\} + \underline{9} \text{ ft}] \\ &= \underline{77} \text{ ft} \times (\underline{3} \text{ ft} + \underline{0} \text{ ft} + \underline{9} \text{ ft}) \\ &= \underline{77} \text{ ft} \times \underline{12} \text{ ft} \\ &= \underline{924} \text{ ft}^2 \end{aligned}$$

- 2) Level site = Cell length (B) x total mound in a box width (W)

$$\begin{aligned} &= \underline{\quad} \text{ ft} \times \underline{\quad} \text{ ft} \\ &= \underline{\quad} \text{ ft}^2 \end{aligned}$$

5. Determine the location of observation pipes along the length of distribution cell.

Observation pipes will be installed in each distribution cell so as to be representative of a cell's hydraulic performance.

- be located such that there are a minimum of two installed in the GSF dispersal cell
- be located near the dispersal cell ends
- be at least 6 inches from the end wall and sidewall
- be installed at an elevation to view the horizontal or level infiltrative surface within the dispersal cell
- Observation pipes may be located less than 6 inches from end walls or side walls if specified in state-approved manufacturers' installation instructions.

## XII. PLAN SUBMITTAL AND INSTALLATION INSPECTION

### A. Plan Submittal

In order to install a system correctly, it is important to develop plans that will be used to install the system correctly the first time. The following checklist may be used when preparing plans for review. The checklist is intended to be a **general guide**. Not all needed information may be included in this list. Some of the information may not be required to be submitted due to the design of the system. Conformance to the list is not a guarantee of plan approval. Additional information may be needed or requested to address unusual or unique characteristics of a particular project. Contact the reviewing agent for specific plan submittal requirements, which the agency may require that are different than the list included in this manual.

#### General Submittal Information

- Photocopies of soil report forms, plans, and other documents are acceptable. However, an original signature is required on certain documents.
- Submittal of additional information requested during plan review or questions concerning a specific plan must be referenced to the Plan Identification indicator assigned to that plan by the reviewing agency.
- Plans or documents must be permanent copies or originals.

#### Forms and Fees

- Application form for submittal, provided by reviewing agency along with proper fees set by reviewing agent.

#### Soils Information

- Complete Soils and Site Evaluation Report (form # SBD-8330) for each soil boring described; signed and dated by a certified soil tester, with license number.
- Separate sheet showing the location of all borings. The location of all borings and backhoe pits must be able to be identified on the plot plan.

#### Documentation

- Architects, engineers or designers must sign, seal and date each page of the submittal or provide an index page, which is signed, sealed and dated.
- Master Plumbers must sign, date and include their license number on each page of the submittal or provide an index page, which is signed, sealed and dated.
- Three completed sets of plans and specifications (clear, permanent and legible); submittals must be on paper measuring at least 8-1/2 by 11 inches.
- Designs that are based on department approved component manual(s) must include reference to the manual by name, publication number and published date.

#### Plot Plan

- Dimensioned plans or plans drawn to scale (scale indicated on plans) with parcel size or all property boundaries clearly marked.
- Slope directions and percent in system area.
- Bench mark and north arrow.
- Setbacks indicated as per appropriate code.
- Two-foot contours or other appropriate contour interval within the system area.
- Location information; legal description of parcel must be noted.

- Location of any nearby existing system or well.

Plan View (see Appendix for sample worksheets)

- Dimensions for distribution cell(s).
- Location of observation pipes.
- Dimensions of mound in a box.
- Pipe lateral layout, which must include the number of laterals, pipe material, diameter and length; and number, location and size of orifices.
- Manifold and force main locations, with materials, length and diameter of each.

Cross Section of System (see Appendix for sample worksheets)

- Include tilling requirement, distribution cell details, berm extensions and cover material.
- Lateral elevation, position of observation pipes, dimensions of distribution cell, and type of cover material such as geotextile fabric, if applicable.

System Sizing

- For one and two-family dwellings, the number of bedrooms must be included.
- For public buildings, the sizing calculations must be included.

Tank And Pump or Siphon Information

- All construction details for site-constructed tanks.
- Size and manufacturer information for prefabricated tanks.
- Notation of pump or siphon model, pump performance curve, friction loss for force main and calculation for total dynamic head.
- Notation of high water alarm manufacturer and model number.
- Cross section of dose tank / chamber to include storage volumes; connections for piping, vents, and power; pump "off" setting; dosing cycle and volume, high water alarm setting, and storage volume above the high water alarm; and location of vent and manhole.
- Cross section of two compartments tanks or tanks installed in a series must include information listed above.

**B. Inspections**

Inspection shall be made in accordance with ch. 145.20, Wis. Stats. and s. SPS 383.26, Wis. Adm. Code. The inspection form on the following two pages may be used. The inspection of the system installation and/or plans is to verify that the system at least conforms to specifications listed in Tables 1 - 3 of this manual.

XIII. POWTS INSPECTION REPORT

(ATTACH TO PERMIT)  
GENERAL INFORMATION

Permit Holder's Name		<input type="checkbox"/> City <input type="checkbox"/> Village <input type="checkbox"/> Town of		County	Sanitary Permit No.		
State Plan ID No.		Tax Parcel No.		Property Address if Available			
<b>TREATMENT COMPONENT INFORMATION</b>				<b>SETBACKS (FT)</b>			
TYPE	MANUFACTURER AND MODEL NUMBER	CAPACITY	P/L	WELL	WATER LINE	BLDG.	VENT
SEPTIC							
DOSING							
AERATION							
HOLDING							
FILTER							

**PUMP / SIPHON INFORMATION**

Manufacturer:		Model No.	Demand in GPM	TDH - Design			
<b>FORCE MAIN INFORMATION</b>			<b>FRICTION LOSS (FT)</b>				
Length	Diameter	Dist. To Well	Component Head	Force Main Losses	Vert. Lift	TDH - As Built	

**SOIL ABSORPTION COMPONENT**

<b>TYPE OF COMPONENT:</b>				<b>COVER MATERIAL:</b>			
Cell Width	Cell Length	Cell Depth	Cell Spacing	No. of Cells			
UNIT		Manufacturer: <u>Eljen Corporation</u>			Model No.		
SETBACK INFO. (FT)	Property Line	Bldg.	Well	Water Line	OHWM		

**DISTRIBUTION COMPONENT**

Elevation data on back of form

Header / Manifold		Distribution Lateral(s)			Orifice size	Orifice Spacing	Obs. Pipes Inst. & No.
Length	Dia.	Length	Dia.	Spacing			

**SOIL COVER**

Depth over center of cell:	Depth over edge of cell:	Depth of Cover material	Texture	Seeded / Sodded	Mulched
----------------------------	--------------------------	-------------------------	---------	-----------------	---------

**DEVIATIONS FROM APPROVED PLAN**

DATE OF INST. DIRECTIVE: \_\_\_\_\_ DATE OF ENFORCEMENT ORDER: \_\_\_\_\_

DATE OF REFERRAL TO LEGAL COUNSEL: \_\_\_\_\_

**COMMENTS** (Persons present, discrepancies, etc.)

**COMPONENTS NOT INSPECTED**

Plan Revision Required <input type="checkbox"/> Yes <input type="checkbox"/> No	Date:	Signature of Inspector:	Cert. Number
--	-------	-------------------------	--------------

Sketch on other side

**ELEVATION DATA**

<b>Point</b>	<b>Back sight</b>	<b>Height of instrument</b>	<b>Foresight</b>	<b>Elevation</b>	<b>Comments</b>
<b>Bench mark</b>					
<b>Bldg. Sewer</b>					
<b>Tank inlet</b>					
<b>Tank outlet</b>					
<b>Tank inlet</b>					
<b>Tank outlet</b>					
<b>Dose tank</b>					
<b>Bottom of dose</b>					
<b>Dist. lateral 1</b>					
<b>System elev. 1</b>					
<b>Dist. lateral 2</b>					
<b>System elev. 2</b>					
<b>Dist. lateral 3</b>					
<b>System elev. 3</b>					
<b>Grade elev. 1</b>					
<b>Grade elev. 2</b>					
<b>Grade elev. 3</b>					

**SKETCH OF COMPONENT & ADDITIONAL COMMENT**

**AT-GRADE USING PRESSURE OR GRAVITY DISTRIBUTION  
COMPONENT MANUAL  
FOR PRIVATE ONSITE WASTEWATER TREATMENT SYSTEMS  
(Version 1.0)**

**January, 2019**

**State of Wisconsin  
Department of Safety & Professional Services  
Division of Safety and Buildings**



**AT-GRADE USING PRESSURE OR GRAVITY DISTRIBUTION  
COMPONENT MANUAL  
FOR PRIVATE ONSITE WASTEWATER TREATMENT SYSTEMS**

<b>TABLE OF CONTENTS</b>	<b>Page</b>
<b>I. INTRODUCTION AND SPECIFICATIONS</b>	<b>3</b>
<b>II. SOIL &amp; SITE REQUIREMENTS</b>	<b>7</b>
<b>III. DESIGN STEPS</b>	<b>7</b>
<b>IV. SITE PREPARATION &amp; CONSTRUCTION</b>	<b>10</b>
<b>V. OPERATION, MAINTENANCE, &amp; PERFORMANCE MONITORING</b>	<b>11</b>
<b>VI. PLAN SUBMITTAL</b>	<b>14</b>
<b>VII. INSTALLATION INSPECTIONS</b>	<b>15</b>
<b>VIII. REFERENCES</b>	<b>15</b>

**Appendix A. – Table A – 383.43-1 (Public Facility Estimated Flows)**

**Appendix B. – At-Grade Component Diagrams for Pressure Distribution**

**Appendix C. – At-Grade Component Diagrams for Gravity Distribution**

**Appendix D. – Observation Pipe Specifications**

Republished on January 2019 by Department of Safety & Professional Services

Republished on January 2012 by Department of Safety & Professional Services

Published on March 01, 2007 by Dept. of Commerce

Division of Safety and Buildings

Safety and Buildings Publication SBD-10854-P (N. 03/07, R. 01/19)

## ADA Statement

The Department of Commerce is an equal opportunity service provider and employer. If you need assistance to access services or need material in an alternate format, please contact the Department at (608) 266-3151 or TTY Contact Through Relay.

## I. INTRODUCTION AND SPECIFICATIONS

This **Private Onsite Wastewater Treatment System (POWTS)** component manual provides design, construction, inspection, operation, and maintenance specifications for an at-grade component. Violations of this manual constitute a violation of chs. SPS 383 and 384, Wis. Adm. Code. The at-grade component must receive influent flows and loads less than or equal to those specified in Table 1. When designed, installed and maintained in accordance with this manual, the at-grade component provides treatment and dispersal of domestic wastewater in conformance with ch. SPS 383 of the Wis. Adm. Code.

Note: Detailed plans and specifications must be developed and submitted for review and approval to the governing unit having authority over the plan review. In addition, a state Sanitary Permit must be obtained from the department or governmental unit having jurisdiction. See Section XII for more details.

<b>PRESSURE DISTRIBUTION:</b> Design Wastewater flow (DWF)	Maximum 5,000 gal/day
<b>GRAVITY DISTRIBUTION:</b> Design Wastewater flow (DWF)	Maximum 600 gal/day
<b>PRESSURE DISTRIBUTION:</b> Volume of a single dose	Minimum 5 times the void volume of the lateral(s) Maximum 20 percent of the design wastewater flow
<b>GRAVITY DISTRIBUTION:</b> Volume of a single dose	Maximum 20 percent of the design flow
Design wastewater flow (DWF) from one- and two-family dwellings	In accordance with s. SPS 383.43(2), (3), (4) and (5), Wis. Adm. Code
Design wastewater flow (DWF) from public facilities	Minimum 150 percent of estimated wastewater flow in accordance with Table 4 of this manual or s. SPS 383.43(6), Wis. Adm. Code.
Monthly average concentrations of BOD <sub>5</sub> , TSS, and FOG	In accordance with s. SPS 383.44(2)(a), Wis. Adm. Code
Linear loading rate restriction	Maximum 4.5 gal/ft if in situ soils have a soil application rate of less than 0.3 gal/ft <sup>2</sup> /day within 12 inches of the ground surface
Wastewater particle size	Maximum 1/8 inch



**Table 2**  
**SIZE AND ORIENTATION**

Total infiltration area	Design wastewater flow ÷ soil application rate for the soil surface. Soil application rates are listed in s. SPS 383 Table 383.44-1 or -2, Wis. Adm. Code.
Maximum infiltration area width (A)	10 ft
Aggregate width on level sites	Infiltration area width (A)
Aggregate width on sloping sites	Infiltration area width (A) + 2 ft
Total width of component area (W)	Aggregate width + 10 ft (5 ft-wide plowed perimeter upslope and downslope of aggregate)
Infiltration area length (B)	Design wastewater flow ÷ soil application rate for the soil surface ÷ infiltration area width (A)
Length of component area (L)	Infiltration area length + 10 ft (5 ft-wide plowed perimeter beyond each end of aggregate)
Minimum depth of aggregate beneath distribution pipe	6 inches
Minimum depth of aggregate above distribution pipe (covering the pipe only)	2 inches
Minimum depth of aggregate at infiltration area edge	6 inches
Minimum depth of topsoil cover over aggregate	12 inches
Orientation	Longest dimension parallel to surface grade contours on sloping sites; 1 percent maximum tolerance allowed
Maximum deflection of infiltration area on concave slopes	10 percent

**Table 3**  
**OTHER SPECIFICATIONS**

Slope of original grade	Maximum 25 percent within the component area.
Vertical distance between the component infiltration surface and a limitation defined by redoximorphic features, groundwater, or bedrock	Minimum vertical distance required by s. SPS 383 Table 383.44-3, Wis. Adm. Code.
<b>PRESSURE DISTRIBUTION</b> methods	Refer to SBD-10706-P, entitled "Pressure Distribution Component Manual for Private Onsite Wastewater Treatment Systems"
<b>GRAVITY DISTRIBUTION</b> methods  For distribution boxes: - Provide a minimum depth of 6 inches of ½" to 2½" aggregate beneath the distribution box to provide a stable footing. - Identify the distribution box by a permanent marker. - Check the distribution box at least once every 36 months for proper function; adjust as necessary.	<p><b>For design flows not exceeding 300 gpd:</b></p> <ul style="list-style-type: none"> <li>- split flow proportionally a minimum of one time (2 volumes proportionally distributed relative to infiltration area supplied)</li> <li>- perforated lateral length not to exceed 38 ft</li> </ul> <p><b>For design flows 301 gpd to 600 gpd:</b></p> <ul style="list-style-type: none"> <li>- split flow proportionally a minimum of two times (4 volumes proportionally distributed relative to infiltration area supplied)</li> <li>- perforated lateral length not to exceed 38 ft</li> </ul> <p>Allowed distribution devices:</p> <ol style="list-style-type: none"> <li>1) Distribution box</li> <li>2) Flow-splitter</li> </ol> <p><b><u>NOTE:</u> Manifold distribution is not permitted.</b></p>
Piping Material in the distribution network	Meets requirements of s. SPS 384.30(2), Wis. Adm. Code for its intended use.
Piping material for observation and vent pipes	Meets requirements of s. SPS 384.30, Table 384.30-1 Wis. Adm. Code.
Aggregate	Meets requirements of s. SPS 384.30(6)(i) & (k), Wis. Adm. Code.
Fabric cover over aggregate	Geotextile fabric meeting s. SPS 384.30(6)(g), Wis. Adm. Code.
Location of distribution lateral(s) (for level sites)	Equally spaced from the center of the distribution cell.
Location of distribution lateral(s) (for sloping sites)	Most upslope lateral to be positioned at 2 feet from upslope edge of distribution cell. If more than one, no lateral may be installed in the lower half of distribution cell.

**Table 3  
OTHER SPECIFICATIONS**

(continued)

Number of observation pipes	Minimum of 2 extending from distribution cell infiltrative surface to finished grade.
Observation pipe position - to provide a representative indication of hydraulic performance	<p>Recommended distance of each observation pipe from each end of the infiltration area is 1/10 to 1/3 of the length of the infiltration area.</p> <p>All observation pipes must be positioned at least 6 inches from the ends and from the downslope edge of the aggregate cover of the infiltration area.</p> <p>(NOTE: Observation pipes may be located less than 6 inches from end walls or side walls if specified in state-approved manufacturers' installation instructions.</p> <p>See <b>Appendix D. – Figure 2.</b> for observation pipe specifications.</p>
Cover material (topsoil)	<ul style="list-style-type: none"> <li>- Capable of supporting sod cover to preclude erosion</li> <li>- Porosity able to allow atmospheric diffusion</li> </ul> <p align="center"><b>DO NOT COMPACT</b></p> <ul style="list-style-type: none"> <li>- Clay content not to exceed 25 percent by weight</li> <li>- Coarse fragment content not to exceed 15 percent by volume and not to exceed 3 inches in diameter</li> </ul>
Limited activities during component construction	<p>Unless, otherwise specifically allowed in this manual, vehicular traffic, excavation, and soil compaction are prohibited:</p> <ul style="list-style-type: none"> <li>- in the plowed area</li> <li>- within 15 feet down-slope of the component area on sloping sites</li> <li>- within 10 feet of both sides of the component area on level sites</li> </ul>
Erosion and frost protection	Graded to divert surface water around the component and sodded or seeded and mulched.
Installation inspection	In accordance with ch. SPS 383, Wis. Adm. Code.
Management	In accordance with ch. SPS 383, Wis. Adm. Code, and this manual.
Horizontal separation between adjacent infiltration areas	No separation required

## II. SOIL AND SITE REQUIREMENTS

### A. Minimum Soil Depth Requirements

The minimum soil factors required for successful at-grade component performance are listed in Tables 1, 2 and 3.

Soil evaluations must be in accordance with ch. SPS 385, Wis. Adm. Code. In addition, soil application rates must be in accordance with ch. SPS 383, Wis. Adm. Code.

### B. Other Site Considerations

1. Slopes: On a crested site, the infiltration area should be centered along the summit so that the effluent can move laterally downslope in both sides. A level site allows lateral flow in all directions. Lateral effluent flow is in one direction only on sloping sites

On sloping sites and on sites with slowly permeable soils, at-grade components rely partially on lateral effluent flow through the upper soil horizons. Lateral movement becomes more important as soil permeability decreases with depth.

Concave sloping sites are sites that have convergence of surface and subsurface drainage. Concave landscape positions are considered unacceptable as at-grade component locations. The allowed maximum deflection for a concave slope is 10 percent.

Final landscape grading in the vicinity of an at-grade component should provide for diversion of surface runoff away from the component site.

2. Setback distances: The setbacks specified in ch. SPS 383, Wis. Adm. Code for soil subsurface treatment and distribution components apply to at-grade components. The distances are measured from the perimeter of the infiltration area.

## III. DESIGN STEPS

Detailed plans and specifications must be developed and then reviewed and approved by the governing unit having authority over plan review.

Design of the at-grade component is based on the design wastewater flow and soil characteristics.

1. Determine Design Wastewater Flow (DWF)

a) For one- and two-family dwellings:

**DWF (gals/day) = 150 gallons/day/bedroom x number of bedrooms**

b) For public or commercial facilities:

$$\text{DWF (gals/day)} = \text{Total Estimated Wastewater Flow (sum of Table 4. sources)} \times 1.5$$

Estimated Wastewater Flows for public and commercial facilities are listed in Table 4. at the end of this manual.

2. Determine the required infiltration area

$$\text{INFILTRATION AREA (ft}^2\text{)} = \text{DWF (gals)} \div \text{Soil Application Rate (gals/day/ft}^2\text{)}$$

Use the soil application rate for the soil surface horizon from Table 383.44-2, Wis. Adm. Code. Note that ch.383.44(4)(c), Wis. Adm. Code, advises to consider more restrictive horizons beneath the surface horizon.

3. Determine the infiltration area dimensions (A = width; B = length)

$$\text{a) INFILTRATION AREA LENGTH (ft)} = \text{Infiltration Area (ft}^2\text{)} \div \text{Infiltration Area Width (ft)}$$

and,

$$\text{b) INFILTRATION WIDTH (ft)} = \text{Linear Application Rate (gal/day/ft)} \div \text{Soil Application Rate (gals/day/ft}^2\text{)}$$

where,

$$\text{LINEAR APPLICATION RATE (gal/day/ft)} = \text{DWF (galls/day)} \div \text{Infiltration Area Length (ft)}$$

or,

$$\text{LINEAR APPLICATION RATE (gal/day/ft)} = \text{Soil Application Rate (gals/day/ft}^2\text{)} \times \text{Infiltration Area Width (ft)}$$

**IMPORTANT:**

Infiltration area width (A) cannot exceed 10 ft.

If the soil has a horizon within 12 inches of the surface with a soil application rate of  $\leq 0.3$  gal/ft<sup>2</sup>/day, the linear loading rate cannot exceed 4.5 gal/ft/day.

4. Percent deflection on concave slopes

The maximum allowed downslope deflection of an at-grade component on a concave slope is 10 percent.

$$\text{a) PERCENT DEFLECTION} = (\text{Deflection} \div \text{Effective Cell Length}) \times 100$$

See Figure 1.

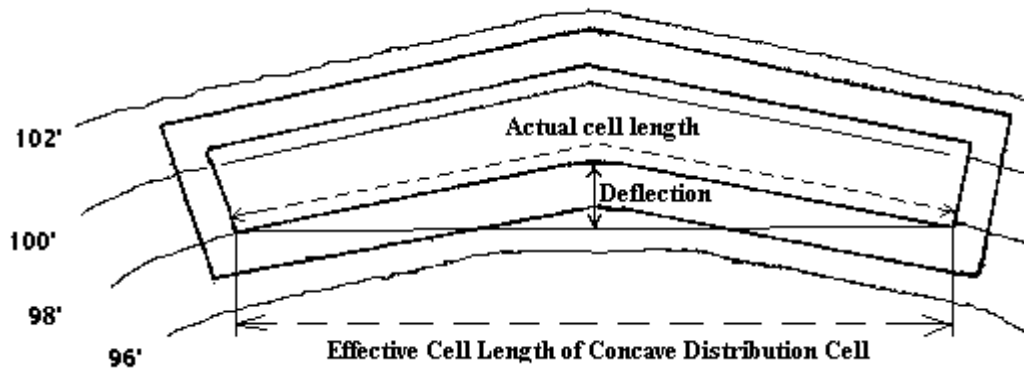

Figure 1. – At-grade component on concave slope

b) **ACTUAL CELL LENGTH = [(Percent Deflection x 0.00265) +1] x Effective Cell Length**

The actual distribution cell length must be checked to determine if the cell area is adequate.

5. Determine the total component width (W = total component width)

a) For level sites:

**TOTAL COMPONENT WIDTH (ft) = Infiltration Area Width (ft) + (2 x 5 ft)**

b) For sloping sites:

**TOTAL COMPONENT WIDTH (ft) = Infiltration Area Width (ft) + (2 x 5 ft) + 2 ft**

6. Determine the total component length (L = total component length)

**TOTAL COMPONENT LENGTH (ft) = Infiltration Area Length (ft) + (2 x 5 ft)**

7. Location of distribution laterals

**Level site:** along the midline of the infiltration area

**Sloping site:** along the upper edge of the Infiltration Area with aggregate extending 2 ft upslope of the lateral

8. Location of observation pipes - See **Table 3**.

## IV. SITE PREPARATION AND CONSTRUCTION

Procedures used in the construction of an at-grade component are just as critical as the design of the component. A good design with poor construction can result in component failure. Plow the soil only when sufficiently dry and not frozen. The construction plan to be followed includes:

### A. Equipment

Proper equipment is essential. Use track type tractors or other equipment that will minimize compaction.

### B. Sanitary Permit

Prior to the construction of the component, a state Sanitary Permit shall be obtained and posted in a clearly visible location on the site. Arrangements for inspections must also be made with the governmental unit issuing the Sanitary Permit.

**NOTE:** When a POWTS is located or will be located on property owned by the state, the Sanitary Permit shall be obtained from the department. Arrangements for inspections shall be made with the department.

### C. Construction Procedures

1. Sites with trees and large boulders: Generally, sites with large trees, numerous smaller trees or large boulders are less desirable for installing an at-grade component. These sites create difficulty in preparing the surface and reduce the infiltration area beneath the at-grade. Rock fragments, tree roots stumps and boulders occupy an area, thus reducing the amount of soil available for proper treatment. If no other site is available, trees in the component area of the at-grade must be cut off at ground level and boulders that are setting on the ground surface removed. A larger infiltration area may be necessary when any of the above conditions are encountered to provide adequate infiltration area.
2. Check the moisture content of the soil to a depth of 8 inches or to the anticipated plow depth, whichever is greater. Smearing and compacting wet soil will result in reducing the infiltration capacity of the soil. Proper soil moisture content can be determined by rolling a soil sample between the hands. If it rolls into a wire at least ¼-inch in diameter, the site is too wet to prepare. If the sample crumbles before attaining at least a ¼-inch diameter, site preparation can proceed. If the site is too wet to plow, do not proceed until it dries.
3. If it rains after the plowing is completed, wait until the soil dries sufficiently before continuing construction. Contact the local inspector for a determination of the extent of damage done by rainfall.
4. Do not plow frozen soil.
5. Lay out the component on the site so that the upslope edge of the infiltration area is level or on a contour line (points of equal elevation).
6. Determine where the force main from the dosing chamber will connect to the distribution lateral(s). Place the force main pipe either before or after plowing. If the force main is

to be installed in the down slope area, the trench for the force main may not be wider than 12 inches.

7. Cut trees as close as possible to the ground surface and leave stumps. Remove surface boulders that can be easily rolled. Remove vegetation over 6 inches long by mowing and raking. Prepare the site by plowing to a depth that will incorporate any residual organic debris and will mitigate any near surface compaction (*i.e.*, plow pans in cultivated fields). Plow perpendicular to the direction of the slope. Plowing with a moldboard plow is done along contours. Chisel plowing is the preferred method, especially in fine textured soils. Rototilling or other means that pulverize the soil is not acceptable. The result of the plowing effort should be an uncompacted and unsmear surface.
8. The required observation pipes must have slots on the bottom 6 inches of the observation pipe. Installations of all observation pipes include a suitable means of anchoring. See Appendix C. - Figure 5.
9. Immediate application of at least 6 inches of aggregate is required after plowing. Shape the aggregate to obtain a uniform minimum depth of at least 6 inches above the original grade. **All vehicular traffic is prohibited on the plowed area.** On sloping sites, vehicular traffic is also prohibited within 15 feet of the downslope edge of the plowed perimeter or within 10 feet of the plowed perimeter on both sides of level sites.
10. Place the distribution lateral(s) on the aggregate. Connect the lateral(s) using the needed connections and piping to the force main pipe from the dosing chamber. The distribution lateral(s) level must be level with the perforations down. All pipes shall drain after dosing.
11. Place at least 2 inches of aggregate over the lateral(s).
12. Place geotextile fabric conforming to requirements of ch. SPS 384, Wis. Adm. Code, over the aggregate.
13. Place soil cover material on top of the geotextile fabric and extend the soil cover over the plowed perimeter of the component.
14. Complete final grading to divert surface water drainage away from the at-grade. Sod or seed and mulch the entire at-grade component.

## **V. OPERATION, MAINTENANCE AND PERFORMANCE MONITORING**

### **A. Owner is Responsible**

The POWTS owner is responsible for the operation and maintenance of the component. The county, department, or POWTS service provider may make periodic inspections of the components to check for surface discharge, ponded effluent levels in the observation pipes, etc.

The owner or the owner's agent is required to submit necessary maintenance reports to the governmental unit or designated agent.



## **B. Approvals and Inspections**

Design approval and site inspection before, during, and after construction is accomplished by the governmental unit or other appropriate jurisdiction(s) in accordance with ss. SPS 383.22 and 383.26, Wis. Adm. Code.

## **C. Routine Precautionary Measures**

1. Inspect treatment and dose tanks along with related mechanical components routinely and maintain when necessary.
2. Wheel traffic, except for lawn maintenance equipment, on the at-grade component is not permitted to avoid frost penetration in winter and to minimize compaction during other times.
3. Conserve water within the structure to assure that the at-grade component will not be hydraulically overloaded.

## **D. User Manual**

A user manual is to accompany the at-grade component plan. Copies of the user manual and the component plan shall be provided to the owner following installation. The manual and the plan shall contain the following information:

1. Diagram(s) of all components and their location. This should include the location of the reserve area, if one is provided.
2. Names and phone numbers of local governmental unit authority, component manufacturer, or POWTS service provider to be contacted in the event of component failure or malfunction.
3. A management plan that contains inspection schedules, maintenance or servicing of the component, including electrical/mechanical components.
4. A list of activities that can or cannot occur on the reserve area, if one is provided.
5. Notice that a dose chamber, if one is utilized, may fill due to flow continuing during pump malfunction or power outages. One large dose when the power comes on or when the pump is repaired may exceed the design flow capacity of the at-grade component. In this situation, the pump chamber should be pumped by a certified septage servicing operator before pump cycling begins, or other measures shall be used to dose the at-grade component without exceeding its design flow capacity. This may include manual operation of the pump controls until such time the pump chamber has reached its normal level.

## E. Performance Monitoring

System performance monitoring must be completed on at-grade components installed in accordance with this manual.

1. The frequency of monitoring must be:
  - a) At least once every three years after installation, and
  - b) At the time of a problem, a complaint, or a failure.
2. The minimum criteria addressed in performance monitoring of at-grade components are:
  - a) Type of use.
  - b) Age of component.
  - c) Nuisance factors, such as odors or user complaints.
  - d) Mechanical malfunction of the system including problems with valves or other mechanical or plumbing components.
  - e) Material fatigue or failure, including durability or corrosion as related to construction or structural design.
  - f) Neglect or improper use, such as exceeding the approved design flow, poor maintenance of vegetative cover, inappropriate cover over the at-grade, or inappropriate activity over the at-grade component.
  - g) Installation problems such as compaction or displacement of soil, improper orientation or location.
  - h) Pretreatment component maintenance, including dosing frequency, structural integrity, groundwater intrusion or improper sizing.
  - i) Pump or siphon chamber maintenance, including improper maintenance, infiltration, structural problems, or improper sizing.
  - j) Ponding in distribution cell, prior to the pump cycle. Ponding may be evidence of development of a clogging mat or reduced infiltration rates.
  - k) Siphon or pump malfunction including dosing volume problems, pressurization problems, breakdown, burnout, or cycling problems.
  - l) Sewage on the ground surface or sewage backup into the structure served.
3. Reports are to be submitted to the governmental unit or designated agent in accordance with ch. SPS 383, Wis. Adm. Code.

## VI. PLAN SUBMITTAL

In order to install a POWTS correctly, it is important to develop plan drawings and specifications to guide the installation and to demonstrate code compliance. All plan submittals shall conform to requirements of SPS 383.22 (2), Wisc. Admin. Code.

The following checklist may be used when preparing plans for review. Conformance to the list is not a guarantee of plan approval. Additional information may be needed or requested to address unusual or unique characteristics of a project. Contact the reviewing agency for specific plan submittal requirements which may be different than the list included in this manual.

- A current version of a completed **Application for Review** form (SBD-10577) along with proper fees must be included with plans submitted to the department. An Application can be downloaded at <http://dsps.wi.gov/SB/docs/SB-FormPowtsAppl10577.pdf> . If plans are to be submitted to a designated county plan review agent, the agent should be contacted for information regarding application forms and fees.
- Soil report (SBD 8330 form) and site map conforming to all the requirements of SPS 385.40, Wisc. Admin. Code
- Index sheet
- System plot plan (consistent with soil report site map)
- At-grade component cross-section diagram showing relevant dimensions
- At-grade component plan view diagram showing relevant dimensions
- Lateral detail diagram(s) showing relevant dimensions
- Dose tank cross-section diagram showing relevant dimensions (for dosed systems only)
- Pump curve (for dosed systems only)
- User manual and management plan

### **HELPFUL NOTE**

Most required plan pages for at-grade components using pressure distribution can be found in a *.pdf* “fillable form” format (“**Standard Plan Pages**”) on the department website at the following link:

<https://dsps.wi.gov/Pages/Programs/PlanReview/POWTS.aspx>

(scroll to the bottom of the page and select the appropriate choices)

## **VII. INSTALLATION INSPECTIONS**

Inspection shall be made by the appropriate government unit in accordance with ch. 145.20, Wis. Stats., and s. SPS 383.26, Wis. Adm. Code. The inspection of the component installation and/or plans is to verify that the component conforms to specifications listed in Tables 1-3 of this manual and to the approved plans.

## **VIII. REFERENCES**

J.C. Converse, E. Jerry Tyler, and James O. Peterson 1990. "Wisconsin At-Grade Soil Absorption System Siting, Design, and Construction Manual" Small Scale Waste Management Project #15.21.

# Appendix A.

A-383.43 (6) COMMERCIAL FACILITIES. Table A-383.43-1 may be used to estimate wastewater flows from a commercial building.

**Table A-383.43-1  
Public Facility Wastewater Flows**

Source	Unit	Estimated Wastewater Flow (gpd)
Apartment or condominium	Bedroom	100
Assembly hall (no kitchen)	Person (10 sq. ft./person)	1.3
Bar or cocktail lounge (no meals served) <sup>a</sup>	Patron (10 sq. ft./patron)	4
Bar or cocktail lounge <sup>a</sup> (w/meals – all paper service)	Patron (10 sq. ft./patron)	8
Beauty salon	Station	90
Bowling alley	Bowling lane	80
Bowling alley <sup>a</sup> (with bar)	Bowling lane	150
Camp, day and night	Person	25
Camp, day use only (no meals served)	Person	10
Campground or camping resort	Space, with sewer connection and/or service building	30
Campground sanitary dump station <sup>a</sup>	Camping unit or RV served	25
Catch basin	Basin	65
Church (no kitchen)	Person	2
Church <sup>b</sup> (with kitchen)	Person	5
Dance hall	Person (10 sq. ft./person)	2
Day care facility (no meals prepared)	Child	12
Day care facility <sup>b</sup> (with meal preparation)	Child	16
Dining hall <sup>a</sup> (kitchen waste only without dishwasher and/or food waste grinder)	Meal served	2
Dining hall <sup>a</sup> (toilet and kitchen waste without dishwasher and/or food waste grinder)	Meal served	5
Dining hall <sup>a</sup> (toilet and kitchen waste with dishwasher and/or food waste grinder)	Meal served	7
Drive-in restaurant <sup>a</sup> (all paper service with inside seating)	Patron seating space	10
Drive-in restaurant <sup>a</sup> (all paper service without inside seating)	Vehicle space	10
Drive-in theater	Vehicle space	3
Employees (total all shifts)	Employee	13
Floor drain (not discharging to catch basin)	Drain	25
Gas station / convenience store	Patron	3
Hospital <sup>a</sup>	Bed space	135
Hotel, motel, or tourist rooming house	Room	65
Manufactured home (served by its own POWTS)	Bedroom	100
Manufactured home community	Manufactured home site	200
Medical office building		
Doctors, nurses, medical staff	Person	50
Office personnel	Person	13
Patients	Person	6.5
Migrant labor camp (central bathhouse)	Employee	20

# Appendix A. (cont.)

**Table A-383.43-1 (Continued)**  
**Public Facility Wastewater Flows**

Source	Unit	Estimated Wastewater Flow (gpd)
Nursing, rest home, community-based residential facility <sup>b</sup>	Bed space	65
Outdoor sport facilities (toilet waste only)	Patron	3.5
Parks (toilets waste only)	Patron (75 patrons/acre)	3.5
Parks (toilets and showers)	Patron (75 patrons/acre)	6.5
Public shower facility	Shower taken	10
Restaurant <sup>a</sup> , 24-hr. (dishwasher and/or food waste grinder only)	Patron seating space	4
Restaurant <sup>a</sup> , 24-hr. (kitchen waste only without dishwasher and/or food waste grinder)	Patron seating space	12
Restaurant, 24-hr. (toilet waste)	Patron seating space	28
Restaurant <sup>a</sup> , 24-hr. (toilet and kitchen waste without dishwasher and/or food waste grinder)	Patron seating space	40
Restaurant <sup>a</sup> , 24-hr. (toilet and kitchen waste with dishwasher and/or food waste grinder)	Patron seating space	44
Restaurant <sup>a</sup> (dishwasher and/or food waste grinder only)	Patron seating space	2
Restaurant <sup>a</sup> (kitchen waste only without dishwasher and/or food waste grinder)	Patron seating space	6
Restaurant (toilet waste)	Patron seating space	14
Restaurant <sup>a</sup> (toilet and kitchen waste without dishwasher and/or food waste grinder)	Patron seating space	20
Restaurant <sup>a</sup> (toilet and kitchen waste with dishwasher and/or food waste grinder)	Patron seating space	22
Retail store (no food preparation)	Patron (70% of total retail area ÷ 30 sq. ft. per patron)	1
School <sup>a</sup> (with meals and showers)	Classroom (25 students/classroom)	500
School <sup>a</sup> (with meals or showers)	Classroom (25 students/classroom)	400
School (without meals or showers)	Classroom (25 students/classroom)	300
Self-service laundry (toilet waste only)	Clothes washer	33
Self-service laundry (with only residential clothes washers)	Clothes washer	400
Swimming pool bathhouse	Patron	6.5

<sup>a</sup> Expected to be high in biological oxygen demand (BOD), total suspended solids (TSS), or fats, oils, and grease (FOG).

<sup>b</sup> At-risk system (potentially high in biochemical oxygen demand (BOD), total suspended solids (TSS), or fats, oils, and grease (FOG)).

**A-383.43 (6) (a)** Actual meter readings may be used to calculate the combined estimated design wastewater flow from a dwelling. To calculate the estimated design wastewater flow use the following formula and compare the answer to the peak metered flow. Choose the larger of the two estimated design flows.

$(\text{total meter flow}/\text{number of readings})(1.5) = \text{estimated design wastewater flow}$

The frequency of meter readings should be daily for commercial.

**A-383.43 (6) (b)** A detailed per capita and per function flow may be established for commercial facilities. The per function flow ratings shall be substantiated by manufactures data of the per function flow and detailed use data from the facility in question or a similar facility under similar conditions of use. Estimated design wastewater flow shall be at least 1.5 times the total estimated daily flow calculated from the per capita and per function flow information.

# Appendix B.

## AT-GRADE COMPONENT CROSS SECTION DIAGRAMS (no scale)



0.5" TO 2.5" WASHED AGGREGATE  
(covered with approved synthetic fabric)



MIN. 12" OF TOPSOIL COVER

Provide a minimum 6-inch  
depth of aggregate beneath  
laterals and a minimum 2-inch  
cover of aggregate over laterals

\* Schdl 40  
PVC Lateral  
for Pressure Distribution

OR

4" Ø Perforated  
PVC Lateral  
for Gravity Distribution  
(See diagram on Pg 24.)

Infiltration Area Width (A) may not exceed 10 ft.

### SLOPING SITE

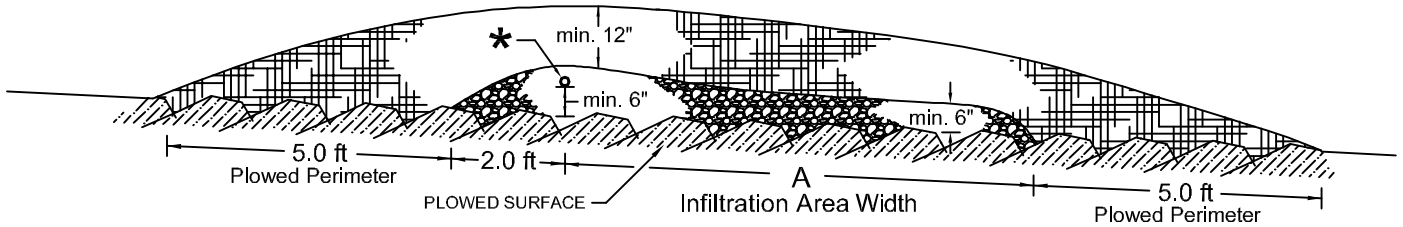

### LEVEL SITE - Single Lateral

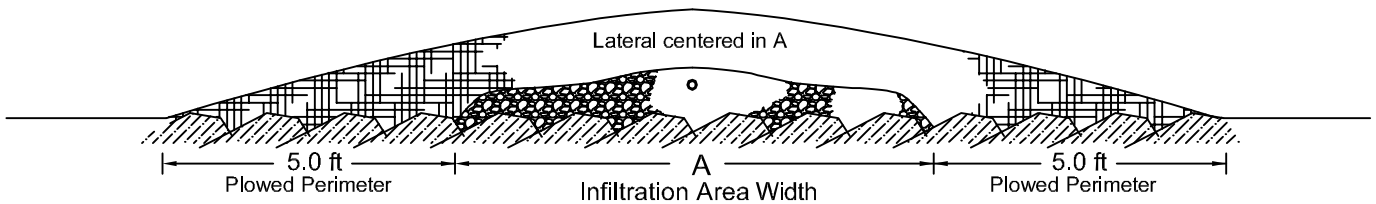

### LEVEL SITE - Double Lateral

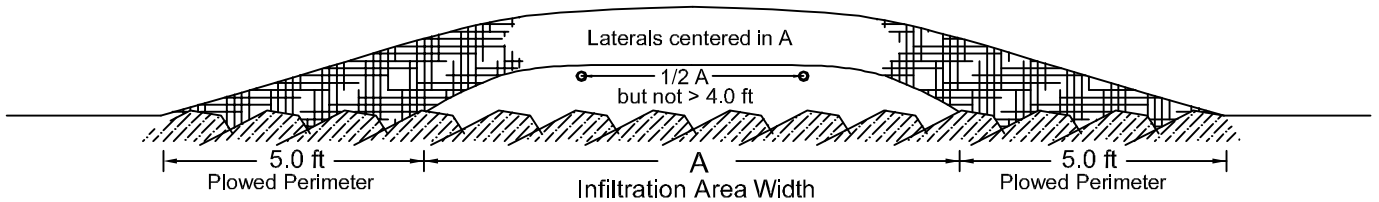

### LEVEL SITE - Triple Lateral

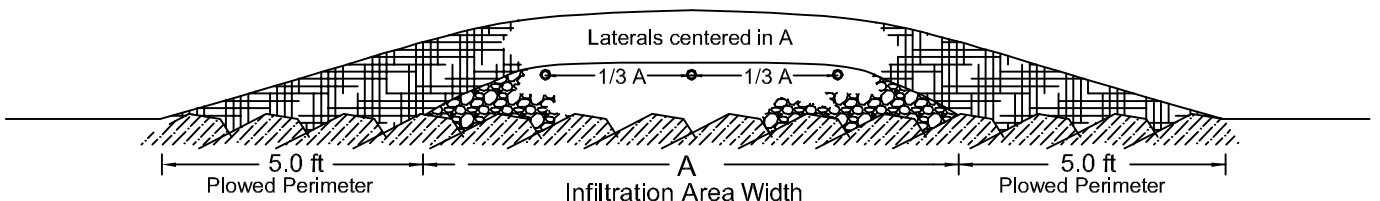

# Appendix B. (cont.)

## AT-GRADE COMPONENT PLAN VIEW DIAGRAMS (no scale)

Infiltration Area Width (A) may not exceed 10 ft.

### SLOPING SITE

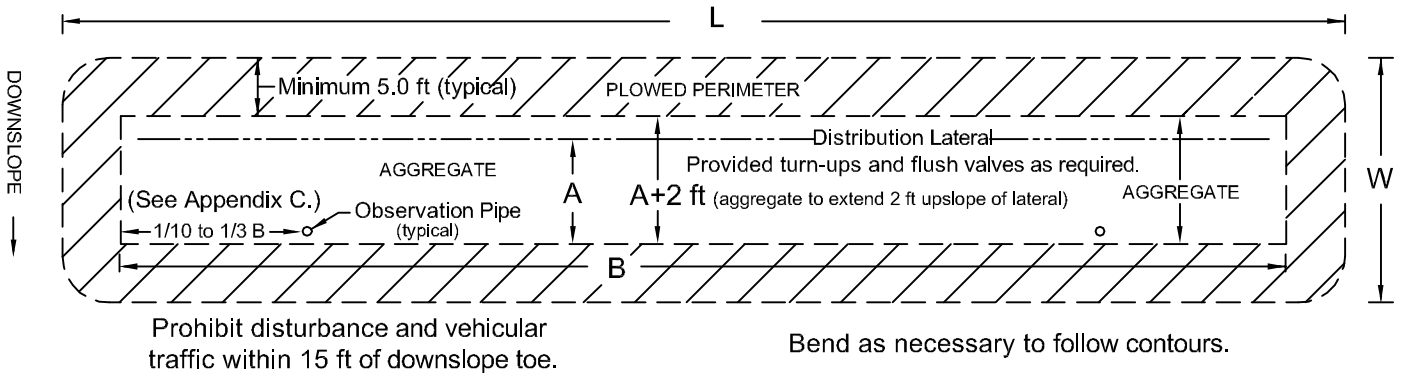

### LEVEL SITE - Single Lateral

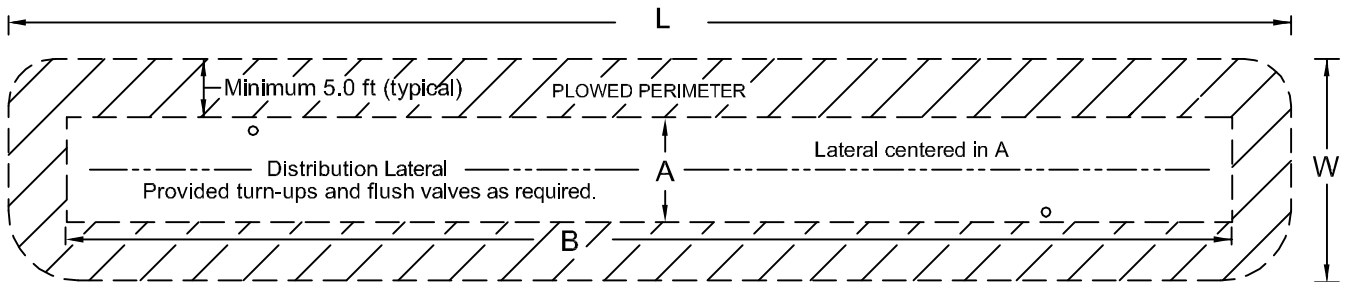

### LEVEL SITE - Double Lateral

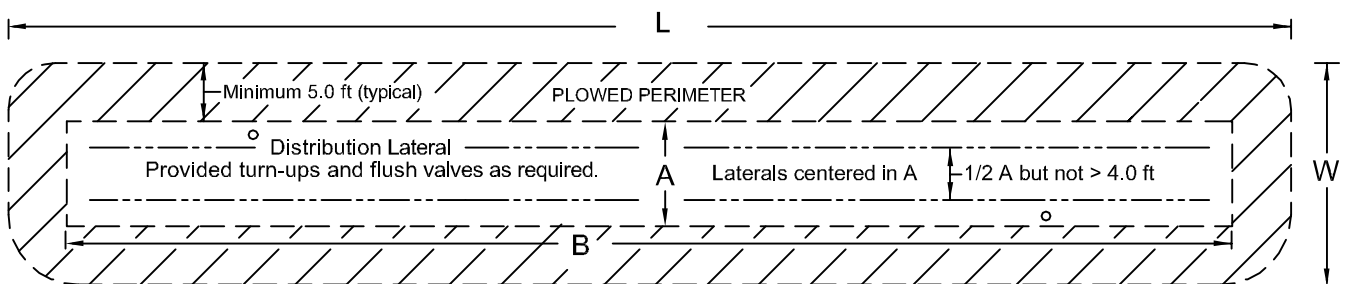

### LEVEL SITE - Triple Lateral

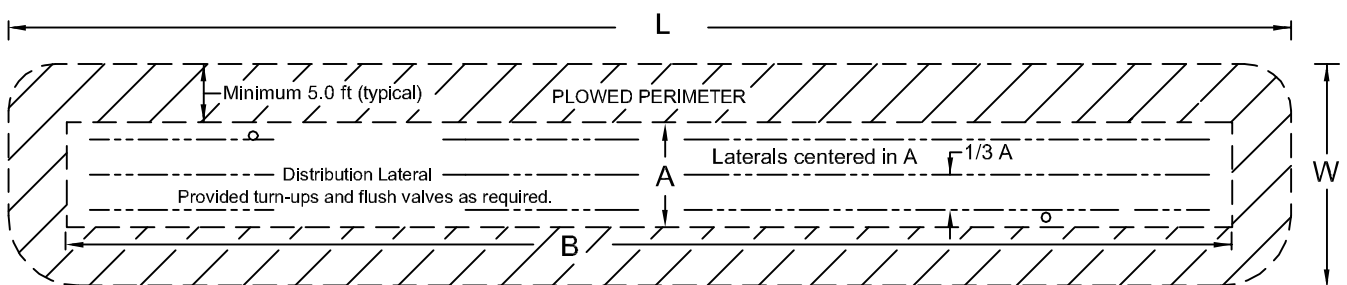



# Appendix C.

## AT-GRADE COMPONENT GRAVITY DISTRIBUTION METHODS (no scale)

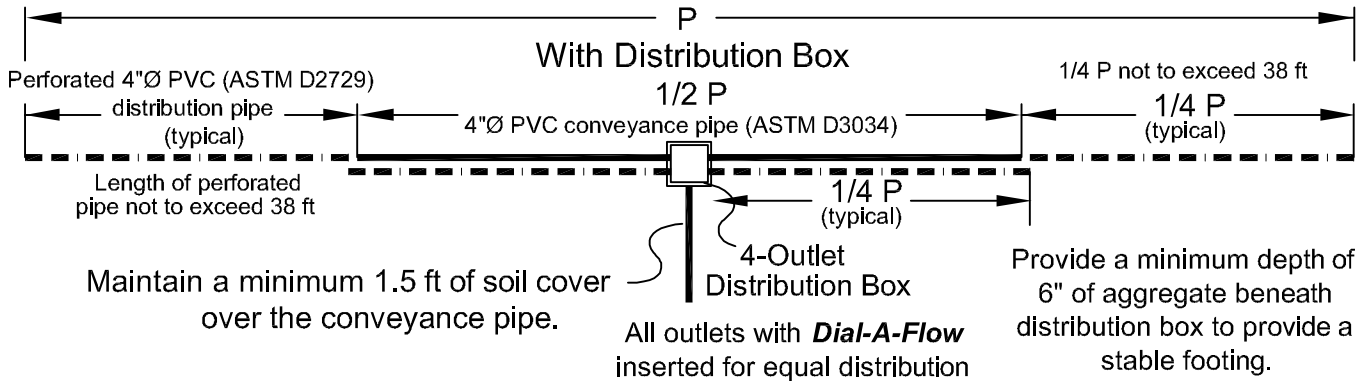
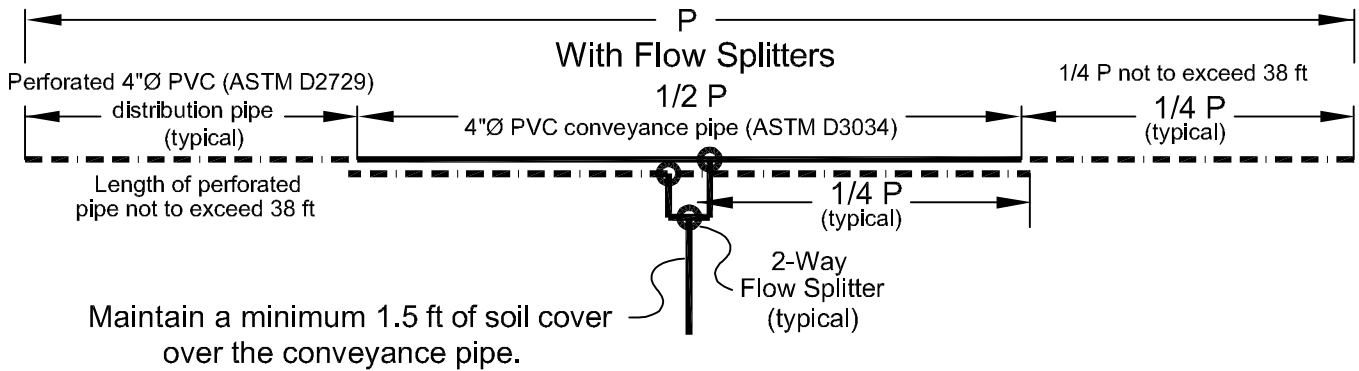

# Appendix D. – Observation Pipe Specifications

Install observation pipes to provide visual inspection of the infiltration surface.

