

Chapter ILHR 82

DESIGN, CONSTRUCTION, INSTALLATION,
SUPERVISION AND INSPECTION OF PLUMBING

ILHR 82.01	Basic plumbing principles (p. 37)	ILHR 82.15	Water conserving fixtures (p. 129)
ILHR 82.02	Plumbing definitions (p. 39)	ILHR 82.16	Health care and related facilities (p. 131)
ILHR 82.03	Fixture unit design basis (p. 50)	ILHR 82.17	Mobile home parks (p. 142)
ILHR 82.04	Building sewers (p. 52)	ILHR 82.18	Joints and connections (p. 146)
ILHR 82.05	Building drains (p. 57)	ILHR 82.19	Materials (p. 151)
ILHR 82.06	Stacks and branches (p. 59)	ILHR 82.21	Hangers and supports (p. 164)
ILHR 82.07	Vents (p. 61)	ILHR 82.22	Repairs and reconstruction (p. 166)
ILHR 82.08	Fixture drain connections (p. 65)	ILHR 82.23	Inspection and tests (p. 166)
ILHR 82.09	Fixtures (p. 78)	ILHR 82.24	Alternate and experimental materials (p. 169)
ILHR 82.10	Traps and cleanouts (p. 81)	ILHR 82.25	Examination of plans and specifications (p. 176)
ILHR 82.11	Interceptors, sumps, ejectors and special and industrial wastes (p. 84)		
ILHR 82.12	Storm and clear water (p. 95)		
ILHR 82.13	Water service and water distribution systems (p. 98)		
ILHR 82.14	Back-siphonage, cross-connections and potability control (p. 123)		

ILHR 82.01 Basic plumbing principles. (1) The basic principles of this code are enunciated as basic goals in environmental sanitation and safety worthy of accomplishment through properly designed, acceptably installed, and adequately maintained plumbing systems. Some of the details of plumbing construction must vary, but the basic sanitary and safety principles are the same. The results necessary to obtain the desired protection for the health of the people are the same everywhere. As unforeseen situations arise which are not specifically covered in the body of this code, the following principles shall serve to define the intent.

(2) Plumbing in all buildings, public and private, intended for human occupation or occupancy, shall at all times be installed in such manner so as to protect the health, safety and welfare of the public or occupants.

(3) Every building intended for human habitation or occupancy shall be provided with a supply of potable water; such supply shall not be cross connected with an unsafe water supply or with a waste pipe nor be subjected to any hazards of backflow or back-siphonage. When the premises abut on a street in which there is a public watermain, there shall be an individual connection to the public system.

(4) Buildings in which water closets and other plumbing fixtures, devices and appurtenances exist or are to be installed shall be provided with a supply of water adequate in volume and pressure by means of proper pipe sizing to insure that efficient use of the fixture is possible at all times.

(5) Devices for heating water and storing it in pressure vessels or tanks shall be so designed and installed as to prevent dangers of explosion or overheating.

(6) Every building intended for human habitation or occupancy on premises abutting on a street in which there is a public sewer shall have an individual connection with the public sewer.

(7) Each family dwelling unit provided with a drainage system shall have at least one water closet, one wash basin, one kitchen sink and one bathtub or shower to meet the basic requirements of sanitation and personal hygiene. All other structures for human occupancy or use shall be equipped with sufficient sanitary facilities as prescribed in this chapter or other applicable Wis. Adm. Code chapters and in no case no less than one water closet and one wash basin shall be provided.

(8) The entire building drainage system shall be so designed, constructed, and maintained as to conduct the waste water or sewage quickly from the fixture to the place of disposal, with velocities which will prevent clogging, fouling and the depositing of solids and shall have adequate cleanouts so arranged that the pipes may be readily cleaned.

(9) The drainage pipes should be so designed and constructed as to be proof for a reasonable life of the building against leakage of water or sewer drain air and offensive odors due to defective materials, imperfect connections, corrosion, settlements or vibrations of the ground or building, temperatures changes, freezing or other causes.

(10) The drainage system shall be so designed that there will be an adequate circulation of air in all pipes, no danger of siphonage, aspiration or forcing of trap seals under conditions of ordinary use.

(11) All rooms in which water closets, urinals or similar fixtures are installed shall have adequate lighting and have proper ventilation to the outer air.

(12) Hot water shall be supplied to all plumbing fixtures which normally need or require hot water for their proper use and function.

(13) Plumbing fixtures shall be made of durable, smooth, nonabsorbent and corrosion resistant material and shall be free from concealed fouling surfaces.

(14) If water closets or other plumbing fixtures exist in buildings where there is no sewer within a reasonable distance, suitable provision shall be made for disposing of the building sewage by some method of sewage treatment or disposal satisfactory to the department and local health authority having jurisdiction.

(15) Plumbing systems shall be maintained in a sanitary condition.

(16) Proper protection shall be provided to prevent contamination of food, water, sterile goods and similar materials by backflow of sewage.

(17) Plumbing shall be designed and adjusted to use the minimum quantity of water consistent with proper performance and cleaning.

(18) Fixtures, devices, appliances and appurtenances shall be supplied with water sufficient in volume and at pressures adequate to enable them to function satisfactorily and without undue noise under all normal conditions of use.

(19) All plumbing fixtures shall be so installed as to provide adequate spacing and shall be reasonably accessible for their intended use and for cleaning.

(20) Sewage or other wastes shall not discharge into water surface or sub-surface soil unless it has first been subjected to some acceptable form of treatment.

History: 1-2-56; r. and recr. Register, October, 1970, No. 178, eff. 11-1-70; r. and recr. (7), Register, November, 1972, No. 203, eff. 12-1-72; renum. from H 62.01, Register, July, 1983, No. 331, eff. 8-1-83.

ILHR 82.02 Plumbing definitions. For the purpose of this code, the following terms shall have the meaning indicated in this section. No attempt is made to define ordinary words which are used in accordance with their established dictionary meaning except where it is necessary to define their meaning as used in this code to avoid misunderstanding.

Note: For definitions of master plumber, journeyman, restricted plumbers, apprentices and registered learners refer to ch. 145, Stats.

(1) **PLUMBING** in this code shall be defined as set forth in s. 145.01 (1) (a), (b), (c), (d) and (e), Stats.

(2) **AIR-BREAK (DRAINAGE SYSTEM).** A piping arrangement in which a drain from a fixture, appliance, appurtenance or device discharges indirectly into another fixture, receptacle, or interceptor at a point below the flood level rim.

(3) **AIR-GAP (DRAINAGE SYSTEM).** The unobstructed vertical distance through free atmosphere between the terminus of the waste pipe and the flood level rim of the fixture, sight waste or other receptacle into which it discharges.

(4) **AIR-GAP (WATER SUPPLY SYSTEM).** The unobstructed vertical distance through the free atmosphere between the lowest opening from any pipe or faucet supplying water to a tank, vat, plumbing fixture or other device and the flood level rim of the receptacle.

(5) **ALIGNMENT.** Installed in a straight line, either horizontal, vertical or at a given angle.

(6) **APPLIANCES AND APPURTENANCES.** Includes any item or type of equipment not otherwise specifically defined, which is connected directly or indirectly with any portion of the plumbing system.

(7) **APPROVED.** Approved or accepted by the state department of health and social services, division of health [industry, labor and human relations].

Note: See sub. (40) for definition of department.

(8) **AREA DRAIN.** A receptacle designed to collect surface or storm waters from an open area.

(9) **ASPIRATOR.** A fitting or device supplied with water or other fluid under positive pressure which passes through an integral orifice or "constriction" causing a vacuum.

(10) **AUTOPSY TABLE.** A fixture or table used for post-mortem examination.

- (11) **BACKFLOW.** The reversal of flow liquids in a piping system.
- (12) **BACKFLOW PREVENTER (REDUCED PRESSURE ZONE TYPE).** An assembly of differential valves and check valves including an automatically opened spillage port to the atmosphere.
- (13) **BACK-SIPHONAGE.** The formation of a negative pressure or vacuum which may occur in a water supply pipe causing the backflow of contaminated or polluted liquids to intermix with the potable water.
- (14) **BACKWATER VALVE.** A device designed to prevent the reverse flow of storm water or sewage into the drainage system or branches thereof.
- (15) **BASEMENT.** The lowest floor line elevation below grade which can be drained to the building sewer by gravity. All other stories below such elevation shall be considered sub-basement levels.
- (16) **BATTERY OF FIXTURES.** Any group of 2 or more similar use adjacent fixtures installed so to discharge into the same common horizontal soil or waste pipe.
- (17) **BEDPAN STEAMER.** A fixture used for scalding bedpans or urinals by direct application of steam.
- (18) **BEDPAN WASHER.** A fixture designed to wash bedpans and to flush the contents into the soil drainage system. It may also provide for sterilizing.
- (19) **BEDPAN WASHER (HOSE).** A device supplied with hot and cold water and located adjacent to a receptacle for cleansing bedpans.
- (20) **BELL (OR HUB).** That portion of a pipe which for a short distance is sufficiently enlarged to receive the end of another pipe of the same diameter for the purpose of making a joint.
- (21) **BOILER BLOW-OFF BASIN.** A vessel designed to receive the discharge from a boiler blow-off outlet and to cool the discharge to a temperature which permits its safe entry into the drainage system.
- (22) **BRANCH.** Any part of a piping system other than a main or stack.
- (23) **BUILDING.** A structure having walls and a roof erected or set upon an individual foundation or slab-constructed base designed or used for the housing, shelter, enclosure or support of persons, animals or property of any kind. For purposes of this code, each structure abutting another structure which does not have an approved ingress-egress doorway through the basement foundation walls, or structures with separate exterior or exterior abutting walls, or public use structures separated by an unpierced firewall, shall be considered as a separate or individual building.
- (24) **BUILDING (PRIVATE RESIDENCE).** A one family building or dwelling. See dwelling unit.
- (25) **BUILDING (PUBLIC).** Means and includes any structure, including exterior parts of such building, such as a porch, exterior platform or steps providing means of ingress or egress, used in whole or in part as a place or resort, assemblage, lodging, trade, traffic, occupancy or use by the public, or by 3 or more tenants.

- (26) **BUILDING DRAIN.** See sewers and drains.
- (27) **BURR.** Roughness or metal protruding from the walls of a pipe usually as the result of cutting the pipe.
- (28) **BY-PASS.** An installation of control valves and piping so installed as to temporarily isolate or by-pass a specific fixture, appliance, equipment or area of piping.
- (29) **CATCH BASIN.** See interceptor.
- (31) **CISTERN.** A covered tank in which rainwater from roof drains is stored for household use or other purposes.
- (32) **CLEANOUT.** A metallic plug or cover joined by means of a screw thread to an opening in a pipe, which can be removed for the purpose of cleaning or examining the interior of the pipe.
- (33) **CLEAR WATER WASTES.** Cooling water and condensate drainage from refrigeration compressors and air-conditioning equipment, waste water drainage used for equipment chilling purposes, liquids having no impurities or where impurities have been reduced below a minimum concentration considered harmful and cooled condensate from steam heating systems or other equipment.
- (34) **CODE.** These regulations, subsequent amendments thereto, or any emergency rule or regulation adopted governing the installation of plumbing, drainage and water supply or distribution system on private property.
- (35) **COMBINATION FIXTURE.** A fixture combining one sink and laundry tray or a 2 or 3 compartment laundry tray in one unit.
- (36) **CONDUCTORS.** The system of roof leaders, downspouts and pertinent piping located inside or outside of building, conveying storm or rainwater from the roofs of buildings or area to the storm drain, storm sewer, catch basin, rainwater cistern or ground surface.
- (37) **CONTINUOUS WASTE.** A drain from 2 compartments of a single fixture connected to a single trap.
- (38) **CROSS-CONNECTION.** Any physical connection or arrangement between 2 otherwise separate piping system, one of which contains potable water and the other either water of unknown or questionable safety, or steam, gas or chemical, whereby there may be a flow from one system to the other, the direction of flow depending on the pressure differential between the 2 systems. See backflow and back-siphonage.
- (39) **DEAD END.** That part of a drainage system which terminates upstream from the base of a vertical soil or waste stack or which is without a free circulation of air.
- (40) **DEPARTMENT.** Department means the department of industry, labor and human relations.
- (41) **DEVELOPED LENGTH.** The length of a pipe line measured along the center line of the pipe and fittings.

(42) **DIP TUBE.** A pipe which conveys the cold water supply to the lower portion of an automatic water heater or water storage tank when the inlet opening is in the top portion of the tank.

(43) **DOMESTIC WASTES.** The water-carried wastes derived from ordinary living processes. See sewage.

(44) **DRAINAGE SYSTEM.** A drainage system includes the piping within public or private premises, which conveys sewage, rainwater or other liquid wastes to a legal point of disposal, but does not include the mains of a public sewerage system or private or public sewage treatment plant.

(45) **DURHAM SYSTEM.** A term used to describe soil or waste systems where all piping is threaded pipe, tubing or other such rigid construction, using recessed drainage fittings, to correspond to the types of piping.

(46) **DWELLING UNIT.** One or more rooms with provisions for living, sanitary and sleeping facilities arranged for the use of one or more individuals of the same family.

(47) **EJECTORS.** A device operated either electrically or by a mechanical means so constructed as to elevate liquid wastes and sewage from a lower level to a point of discharge into a public or private sewer or other final means of disposal.

(48) **FERRULE.** A metallic sleeve used to connect dissimilar plumbing materials.

(49) **FIRE PROTECTION SYSTEM.** A system of pipes and appurtenances used exclusively to supply water for extinguishing fires except the water service pipe as stipulated in s. 145.01 (1) (c), Stats.

(50) **FIXTURE.** A receptacle, appliance, device or equipment with or without a connection to the water supply system intended to receive or discharge water, liquids or water-carried wastes directly or indirectly into a drainage system.

(51) **FIXTURE UNIT.** A design factor so chosen that the load producing values can be expressed as multiples of that factor.

(52) **FIXTURE UNIT (DRAINAGE D.F.U.)** A measure of the probable discharge into the drainage system by various types of plumbing fixtures. The drainage fixture unit value for a particular fixture depends on its volume rate of discharge, on the duration of a single drainage operation and on the average time between successive operations.

(53) **FIXTURE UNIT (WATER SUPPLY S.F.U.)** A measure of the probable hydraulic demand on the water supply by various types of plumbing fixtures. The supply-unit value for a particular fixture depends on its volume rate of supply, the time duration of a single supply operation and the average time between successive operations.

(54) **FIXTURE UNIT FLOW RATE.** The total discharge flow in gallons per minute of a single fixture divided by 7.5 provides the flow rate of a particular fixture as a unit of flow. Fixtures are rated as multiples of this unit of flow.

(55) **FLOOD-LEVEL RIM.** The flood-level rim is the top edge of the receptacle from which water overflows.

(56) **GARAGE (PUBLIC)**. A building or part of a building which accommodates or houses self-propelled land, air or water vehicles for 3 or more persons not of the same family.

(57) **GARAGE (PRIVATE)**. A building used for the storage of vehicles or other purposes by a private family and which is not available for public use.

(58) **GRADIENT**. The fall or slope of a line of pipe in reference to a horizontal plane. In drainage systems it is usually expressed as the fall in a fraction of an inch per foot length of pipe.

(59) **HORIZONTAL PIPE**. Any pipe or fitting which makes an angle of less than 45° to the horizontal.

(60) **HOT WATER**. Water at a temperature of 120° F. or more.

(61) **INDIRECT WASTE PIPE**. A waste pipe which does not connect directly to the drainage system, but conveys liquid wastes by discharging into the drainage system through an air-break, air-gap, into a trap, fixture, receptacle or interceptor.

(62) **INDUSTRIAL WASTES**. The liquid wastes resulting from the processes employed in industrial establishments which are free from fecal matter.

(63) **INTERCEPTOR**. A device designed and installed so as to retain deleterious, hazardous or undesirable matter from normal wastes while permitting normal sewage or liquid wastes to discharge into the drainage system by gravity.

(64) **GREASE BASIN (EXTERIOR)**. A watertight tank installed underground for the collection and retention of grease from cooking or food processing and which is accessible for periodic removal of the contents.

(65) **GREASE INTERCEPTOR**. A receptacle designed to intercept and retain grease or fatty substances contained in kitchen and other food wastes.

(66) **GRIT & SAND INTERCEPTOR**. A receptacle designed to intercept and retain sand, grit, earth and other similar solids.

(67) **OIL INTERCEPTOR**. A unit designed to intercept and retain oil, lubricating grease or other like materials.

(68) **MANHOLE**. An opening constructed to a sewer or any portion of a plumbing system of sufficient size to permit a man to gain access thereto.

(69) **MAY**. May implies neither compulsion nor recommendations, only permission.

(70) **MOBILE HOME**. A mobile home is a transportable structure mounted on a chassis and designed to be used with or without a permanent foundation as a dwelling unit. The phrase "without a permanent foundation" indicates that the support system is constructed with the intent that the mobile home thereon will be moved from time to time at the convenience of the owner. See ss. 218.12 and 348.07 (2), Stats.

(a) *Mobile home park sewerage system*. All structures and piping by which sewage is collected, conveyed and disposed of.

ILHR 82

(b) *Mobile home building sewer.* That part of the plumbing system designed to serve one mobile home site from the mobile home drain connector to its connection with the mobile home park main or private disposal system.

(c) *Mobile home drain connector.* The terminal of all soil or waste piping of a mobile home to which the final waste connection is made to the building sewer.

(d) *Mobile home park water main.* That part of the water distribution system which extends from the street main or private supply to the mobile home water service.

(e) *Mobile home water service.* That part of the water service piping extended from the park water main, or private system, to one mobile home site.

(71) **NON-POTABLE WATER.** Water not safe for human consumption, hygiene or culinary use.

(72) **NUISANCE.** A "nuisance" under this section is referred to as any source of filth or probable cause of sickness pursuant to the provisions of s. 146.14 Stats.

(73) **PIPE DIAMETERS.** When used in this code, shall mean the inside cross sectional dimension.

(74) **PLACE OF EMPLOYMENT.** Every place, whether indoors or out, or underground, and the premises appurtenant thereto, where either temporary or permanently any industry, trade or business is carried on, or where any process or operation, directly or indirectly related to any industry, trade or business is carried on and where any person is directly or indirectly employed by another for gain or profit, but shall not include any place where persons are employed in private or domestic service or agricultural pursuits which do not involve the use of mechanical power.

(75) **PLUMBING SYSTEM.** The plumbing system includes all water supply, water services and water distribution piping, plumbing fixtures and traps; soil, waste, and vent pipes; building drains, building sewers and private domestic sewage disposal systems including their respective connections, equipment, devices, appliances and appurtenances within the property line of the premises; and water-treating or water-using equipment in connection with the water and drainage systems and the installation thereof.

(76) **POTABLE WATER.** Potable water is water which is satisfactory for human consumption, hygiene and culinary use and meets the requirements of the state administrative authority having jurisdiction.

(76a) **PRIVATE SEWAGE SYSTEM.** Private sewage system means a system defined in s. ILHR 83.02 (40).

(77) **PRIVY.** A structure used by the public for the deposition of human body wastes.

(78) **PRIVY VAULT.** A watertight pit receptacle beneath a privy which receives human body wastes.

(79) **PROCESS PIPING.** Process piping is piping separated from the water distribution and/or drainage system by approved methods or means and used exclusively for refining, manufacturing, industrial or shipping purposes of every character and description.

(80) **RADIUS.** Radius is the distance from a center line or point to an axis of rotation.

(81) **RECEPTOR.** A fixture or device which receives the discharge from indirect wastes pipes.

(82) **REPAIRS & STOPPAGES.** Consists of making minor repairs to faucets, valves, pipes, appliances and removing of stoppages in building drains and sewers or waste pipes.

(83) **ROUGHING-IN.** The installation of all soil, waste, vent, water supply piping and supports pertinent thereto within a building to which fixtures, appliances and equipment are to be connected.

(84) **SAFING.** A pan or other collector placed beneath a pipe or fixture to prevent leakage from escaping to the floor, ceiling or walls.

(85) **SANITARY SEWER.** A sanitary sewer is a pipe which carries sewage and excludes storm, surface and ground waters.

(86) **SEWAGE.** The water carried wastes (organic) created in and to be conducted away from residences, industrial establishments and public buildings. See domestic wastes.

(87) **SEWERAGE SYSTEM (PUBLIC).** All structures, conduits and pipe lines by which sewage is collected and disposed of, except plumbing inside and in connection with buildings and properties served, and service pipes from building to street main. See ch. 144, Stats.

(88) **RESERVOIR.** Reservoir means a watertight receptacle basin or vault constructed above the ground surface or underground for the storage of potable water.

(89) **SEWERS & DRAINS.** (a) *Sanitary.* 1. Building sewer. That part of the plumbing system beginning at the immediate outside foundation or proposed foundation wall to its connection with the main of a public sewer, private sewer, private sewage disposal system or other point of disposal.

2. Building drain. The lowest horizontal piping of a drainage system which receives the discharge of soil, waste and other drainage pipes inside any building and conveys same to the building sewer by gravity flow. See s. ILHR 82.08 (2) (c), sketch.

3. Building drain branch. That part of any drainage system which extends laterally at a slight grade, with or without horizontal change of direction from the building drain or subdrain. In this definition, horizontally means an angle less than 45° with a horizontal plane and a rise not to exceed the inside diameter of the branch. See s. ILHR 82.08 (2) (c), sketch.

4. Building subdrain. The horizontal portion of a drainage system within a building which cannot flow by gravity to the building drain.

(b) *Storm*. 1. Building sewer. That part of the storm water system which receives the discharge from building storm drains and subdrains, parking lots, yard fountains and other permissive sources, and conveys such waters to a public storm water system, private storm water system or other approved point of disposal.

2. Building drain. The lowest horizontal piping which receives storm waters or other permissive water from roofs, area ways, court yards, canopies, enclosed parking ramps and other sources inside any building or structure and conveys same to the building storm sewer by gravity flow.

3. Building subdrain. Same as sanitary subdrain.

(90) SEWER. (a) *Private*. A privately owned building sewer serving a single building.

(b) *Private interceptor main sewer*. A privately owned building sewer not directly controlled by public authority. Privately owned means single ownership by an individual, firm or corporation, and approved by local authority and the department.

(91) SEWER (PUBLIC). A publicly owned sewer.

(92) SUBSOIL DRAIN. That part of a drainage system which conveys the ground or seepage water from the footings of walls or below the basement floor under buildings to the storm sewer or other point of disposal.

(93) SHALL. The word "shall" when used in this code is a mandatory requirement.

(94) SHOULD. "Should" is not mandatory but expresses the recommendation of the department.

(95) SIPHONAGE. A suction created by the flow of liquids in pipes.

(96) SLIP-JOINT. A connection in which one pipe slips into another, the joint of which is made tight with a compression type fitting.

(97) SPECIAL WASTES. Wastes which require special treatment before entry into the normal plumbing system.

(98) SPECIAL WASTE PIPE. Piping which conveys special wastes.

(99) SPIGOT. The end of a pipe which fits into a bell or hub.

(100) STACKS & BRANCHES. (a) *Stacks*. 1. Soil stack. Any pipe extending vertically which conveys the discharge of water closets, bedpan washers or like fixtures with or without other fixtures to a horizontal branch, building drain or building subdrain.

2. Waste stack. Any pipe extending vertically which receives only liquid wastes free from fecal matter and conveys same to a horizontal branch, the building drain or building subdrain.

(b) *Branches*. 1. Branch. A horizontal drain pipe extending from a soil or waste stack to which vertical sections or extensions may be connected which receive the discharge from one or more fixture drains.

2. Branch interval. A distance along a soil or waste stack corresponding in general to a story height but in no case less than 8 feet within which

the horizontal branches from one story of a building are connected to the stack.

(101) **STERILIZERS.** (a) *Boiling type.* A non-pressure type device used for boiling instruments, utensils, and/or other equipment for disinfection purposes.

(b) *Pressure instrument washer-sterilizer.* A pressure vessel fixture designed to both wash and sterilize instruments during the operating cycle of the unit.

(c) *Pressure (autoclave).* A pressure vessel designed to use steam under pressure for sterilizing. Also called an autoclave.

(d) *Water.* A device used for sterilizing water and storing sterile water.

(102) **STILL.** A device used in distilling liquids.

(103) **SUMP.** A tank or pit which receives sewage or liquid wastes located below the normal grade of the gravity system and which must be emptied by mechanical means.

(104) **SUMP PUMP.** A mechanical device other than an ejector for removing liquid waste from a sump.

(105) **SUPPORTS.** Supports, hangers, anchors and other devices for supporting and securing pipes, or fixtures to walls, ceilings, floors or structural members of a building.

(106) **SWIMMING POOL.** Any structure, basin, chamber or tank containing an artificial body of water for swimming, diving or recreational bathing having a depth of 2 feet or more at any point.

(107) **TERMINAL.** That part of a drainage or vent piping system which projects above the roof of the building or at the end of the building effluent disposal system.

(108) **TRAP.** A fitting or device so designed and constructed as to provide, when properly vented, a liquid seal which will prevent the back passage of sewer air without materially affecting the flow of sewage or waste through it.

(a) *Trap crown.* Where the trap connects to or becomes a part of the horizontal arm of the trap which is integral with the trap.

(b) *Trap seal.* Trap seal is indicated by the height of the water column measured between the overflow and the dip separating the inlet and outlet arms of the trap.

(109) **TURF SPRINKLER UNIT.** A system of piping, appurtenances and devices so installed as to distribute water for lawn or other similar irrigation purposes without plumbing fixtures or means of use for human consumption.

(110) **VACUUM BREAKER.** An atmospheric device, pipe installed and designed to protect a water supply against back-siphonage by entry of air to relieve vacuums in the water distribution system. (A vacuum breaker is not designed to protect the water supply under conditions of backflow or back-pressures.)

(111) VENT PIPE. Any pipe provided to ventilate a plumbing system.

(a) *Back vent.* A pipe that connects to a soil or waste pipe to vent a single fixture trap and connects to the vent system above the fixture served with no part of it below the fixture trap.

(b) *Branch vent.* That part of the vent piping which extends horizontally with or without lateral or vertical extensions and to which other vent pipes connect.

(c) *Circuit vent.* A vent pipe which serves 2 or more fixture traps which discharge to a nearly horizontal soil or waste branch and extends from the downstream side of the furthestmost upstream fixture trap to the main soil or waste vent or main vent so that a circuit is formed.

(d) *Continuous vent.* A vertical vent pipe that is a continuation of the vertical waste pipe to which it connects.

(e) *Loop vent.* Similar to a back vent except that part of it extends below the trap it serves before reconnecting to the vent piping system.

(f) *Main soil or waste vent.* That part of the stack above the highest installed fixture opening or branch connection. (Commonly referred to as a stack vent.)

(g) *Main vent.* A vent pipe connected to the base of a soil or waste stack below the lowest fixture branch extending vertically with or without change of direction and which serves as a terminal for other vent pipe connections and terminates through the roof or connects with the main soil or waste pipe at a point 2 feet or more above the highest soil or waste opening, but in no case less than 38 inches above the highest floor on which soil or waste openings are installed.

(h) *Relief vent.* The vent pipe connected to a soil or waste pipe close to the stack in a manner to equalize minus and plus pressures in the stack.

(i) *Stack venting.* A method of venting a fixture or group of fixtures through the soil or waste stack.

(j) *Sterilizer vent.* A separate pipe or stack connected indirectly to the building drainage system at the lowest terminal, which receives the vapors from non-pressure sterilizers or the exhaust vapors from pressure sterilizers and conducts the vapors directly to the outer air. (Commonly referred to as vapor, steam, atmospheric or exhaust vent.)

(k) *Unit vent.* One which denotes an installation so arranged that one pipe will serve traps from 2 identical fixtures at the same point when connected to a vertical soil or waste pipe.

(l) *Wet vent.* That portion of a vent pipe which receives the discharge from wastes other than water closets, kitchen fixtures or other sources containing like sewage of fecal matter.

(m) *Yoke vent.* A pipe connecting upward from a soil or waste stack into a main vent pipe in a manner to equalize pressures within the stacks.

(112) WATER HEATERS AND RELATED ITEMS. (a) *Water heater.* A closed vessel in which water is heated by the combustion of fuels, electricity or any other source and withdrawn for use external to the system at pressures not exceeding 160 p.s.i.g. and shall include the apparatus by which

heat is generated and all controls and devices necessary to prevent water temperatures from exceeding 210° F.

(b) *Hot water storage tank.* A hot water storage tank is a tank used to store water that is heated indirectly by a circulating water heater or by steam or hot water circulating through coils or by other heat exchange methods internal or external to the tank.

(c) *Hot water supply boiler.* A boiler completely filled with water that furnishes hot water to be used externally to itself at pressures not exceeding 160 p.s.i.g. or at temperatures not exceeding 250° F.

(113) **WATER CONDITIONER.** An appliance, appurtenance or device used for the purpose of ion exchange, demineralizing water or other methods of water treatment.

(114) **WATER SUPPLY (PRIVATE).** Private water supply means one or more sources of groundwater, including facilities for conveyance thereof, such as wells, springs and pumps, on one property, other than those serving a municipality or a group of 10 or more premises of mixed ownership.

(115) **WATER SERVICE.** A pipe extended from the water main or private pumping system or other supply source with or without lateral extensions to the building, structure or other system to be served.

(116) **WATER DISTRIBUTION SYSTEM.** (a) Piping which conveys water from the service to the plumbing fixtures, appliances, appurtenances, equipment, devices or other systems served including fittings and control valves.

1. **Water distribution main.** The principal water distribution pipe to which risers, branch mains or branches are connected.

2. **Water distribution riser.** A water distribution pipe which extends vertically one full story or more to convey water to mains, branch mains, branches or a group(s) of fixtures.

3. **Water distribution branch main.** A water distribution pipe to convey water to a riser, a pipe serving 2 or more branches with or without other branch mains.

4. **Water distribution branch.** Any part of the water distribution piping system other than a main, riser or branch main to within 18 inches or less of one or more fixtures.

5. **Fixture supply connections.** That part of the piping system within 18 inches or less from the fixture supply branch to the fixture.

(117) **WIPED JOINT.** The fusion of metal with solder, smoothly finished with a wiping cloth and having a thickness of at least ¼-inch at the point where the pipes are joined.

(118) **WORKMANSHIP.** Work of such character that will fully secure the results sought in all the sections of this code as intended for the safety, welfare and health protection of all individuals.

(119) **YARD DRAIN.** The horizontal piping and its branches which convey the surface drainage from areas, courts or yards outside the walls of a building to the storm water sewer.

(120) MISCELLANEOUS. Standards or Specifications Abbreviations.

- A.G.A. -----American Gas Association, Inc.
420 Lexington Ave., New York, New York 10017
- A.N.S.I. -----American National Standards Institute, Inc.
1430 Broadway, New York, New York 10018
- A.S.M.E. -----American Society of Mechanical Engineers
29 W. 39th St., New York, New York 10018
- A.S.S.E. -----American Society of Sanitary Engineering
960 Illuminating Building, Cleveland, Ohio 44113
- A.S.T.M. -----American Society for Testing and Material
1916 Race St., Philadelphia, Pa. 19103
- A.W.W.A. -----American Water Works Association
2 Park Avenue, New York, New York 10016
- C.S. -----Commercial Standards, Supt. of Documents
Governmental Printing Office, Washington, D.C.
20401
- F.S. -----Federal Specifications
General Services Administration, Regional Office 3,
Washington, D.C. 20407
- M.S.S. -----Manufacturers Standardization Society
of the Value and Fittings Industry
420 Lexington Ave., New York, New York 10017
- N.S.F. -----National Sanitation Foundation
Testing Laboratory, Inc., P.O. Box 1468,
Ann Arbor, Michigan 48106
- U.L. -----Underwriters' Laboratories, Inc.
207 E. Ohio Street, Chicago, Illinois 60611
- W.C.F. -----Water Conditioning Foundation
1201 Waukegan Road, Glenview, Illinois 60025

History: 1-2-56; am. (8), (42) (b) and (c); (46) and (49), Register, February, 1957, No. 14, eff. 3-1-57; r. and recr. Register, October, 1970, No. 178, eff. 11-1-70; cr. (119), Register, October, 1971, No. 190, eff. 11-1-71; r. and recr. (70); (79) through (118) are renum. to be (80) through (119); (119) is renum. to be (79); am. (89) (a) 2. and 3. as renum., r. and recr. (90) as renum. Register, November, 1972, No. 203, eff. 12-1-72; r. and recr. (88) (a) 4, Register, July, 1976, No. 247, eff. 8-1-76; renum. (88) (a) 11. to 18. to be 12. to 19., cr. 11. and 20., renum. (113) to (119) to be (114) to (120), recr. (116), renum. (112) to be (113) and am., cr. (112), Register, January, 1979, No. 277, eff. 2-1-79; r. (30), am. (40), cr. (76a), r. and recr. (88), Register, December, 1980, No. 300, eff. 1-1-81; renum. from H 62.02, Register, July, 1983, No. 331, eff. 8-1-83.

ILHR 82.03 Fixture unit design basis. (1) **INTERMITTENT FLOW FIXTURES.** The fixture unit value and the size of traps, vents, and piping shall be as designated in the following table for any fixture named therein. For fixtures not included in the following table, contact the department for the fixture value rating. Equivalent value for other intermittent operating fixtures shall be one fixture unit for each 7.5 gallons per minute of flow rate.

Table 1

Type of Fixture	Unit Value	Trap Minimum Size Inches	Soil or Waste Minimum Size Inches	Vent Minimum Size Inches
Automatic clothes washers, Commercial (individual).....	4	2	2	1½
Commercial (large capacity)*	3	1½	1½	1½
Residential.....	3	1½	1½	1½
Bathtubs, all types**.....	6	2	3	2
Bed pan washer.....	2	1½	1½	1½
Bidet.....	1	1½	1½	1½
Cuspidor, fountain or dental.....	4	1½	1½	1½
†Dishwasher (commercial)***	1	1½	1½	1½
†Dishwasher (residential).....	4	1½	1½	1½
Drinking fountain.....	1	1½	1½	1½
Drinking fountain (refrigerated).....	½	1½	1½	1½
Floor drain, 2 inch.....	3	2	2	1½
3 inch or larger****.....	4	3	3	2
Laundry tray.....	3	1½	1½	1½
†Refrigerated cases.....	1	1½	1½	1½
Shower stall, each head.....	4	2	2	1½
Sinks, Cup.....	1	1½	1½	1½
Factory wash-up.....	4	1½	1½	1½
Fountain or bar.....	3	1½	1½	1½
Food waste disposers (commercial).....	2 HP or less	1½ or 2	2	1½
Food waste disposers (commercial).....	3 HP or more	3	3	2
Laboratory.....	2	1½	1½	1½
Laboratory, school.....	2	1½	1½	1½
Classroom juvenile.....	2	1½	1½	1½
Pack or plaster.....	4	2	2	1½
Residential (with or without F.W.G.)	4	1½	1½	1½
Restaurant, Scully, pots and pans.....	4	2	2	1½
Food, rinsing, cleaning or thawing...	3	1½	1½	1½
Service sink, flushing rim.....	6	3	3	2
Service sink, wall outlet.....	4	2	2	1½
Service sink, wall outlet.....	4	3	3	2
Service sink, floor outlet.....	4	2	2	1½
Service sink, floor outlet.....	4	3	3	2
Shampoo sink, barber or beauty parlor.....	2	1½ or 1½	1½	1½
Surgeons, wash-up.....	3	1½	1½	1½
Sterilizer, Bed pan.....	4	2	2	1½
Garbage can washers.....	3	3	3	2
†Instrument or water.....	1	1½	1½	1½
Urinal, Men.....	4	2	2	1½
Women.....	6	2½	3	2
†Vegetable display cases.....	2	1½	1½	1½
Wash basin.....	1	1½	1½	1½
Water closet, tank type.....	6	2	3	2
Water closet, flush valve.....	8	2	3	2

*Based on discharge rate (See sub. (2).)

**Includes foot, Sitz and infant baths and regular bathtubs with or without showers.

***Based on discharge rates and number of outlets, 4" trap and waste pipe minimum recommended.

****Trap and waste pipe sizes to correspond to floor drains.

†Requires air-gap discharge.

(2) CONTINUOUS FLOW FIXTURES. Fixtures such as pumps and ejectors from which there is continuous or semi-continuous discharge shall have a fixture unit value of one for each one gallon per minute of flow.

(3) **UNIT CAPACITY AND LENGTH OF SANITARY PIPING.** The number of fixture units connected to any stack, branch or vent and the length of piping shall not exceed that shown in the following table for a given diameter of pipe. After maximum length of vent for any given pipe size is reached, the diameter of the pipe shall be increased to the next size.

Table 2
FIXTURE UNIT CAPACITY AND MAXIMUM WATER CLOSETS OR LIKE
FIXTURES ON SOIL, WASTE OR VENT PIPE

Pipe		Soil or Waste			Vent	
Diameter (Inches)	Fix. Units on Vertical Pipe	Water Closets or Like Fixtures on Vertical Pipe	Fix. Units on Horizontal Pipe	Water Closets or Like Fixtures on Horizontal Pipe	Fix. Units on Vent (See Limitations)	Maximum Length Vent (in feet)
1½	1		1		1	50
1½	8		4		12	65
2	18		9		24*	85
2½	40		20		60*	105
3	50	2	25*	1	126**	212
4	252	33	126	17	252	300
5	680	80	340	40	680	390
6	1,380	120	690	60	1,380	510
8	3,600	225	1,800	112	3,600	750
10	7,600	400	3,800	200	7,600	—
12	12,000	575	6,000	288	12,000	—

*Limitation of one 6 or 8 fixture unit fixture.

**Limitation of six 6 or 8 fixture unit fixtures.

Table 3
GRAVITY CONDENSATION DRAINS TOTAL NUMBER OF CONNECTIONS

Drain Outlet Size	Indirect Main Waste Size							Assigned Fixture Unit Value
	¾	1	1¼	1½	2	2½	3	
½	2	4	6	9	16	25	36	0-¾
¾	1	1	3	4	7	11	16	0-½
1	0	1	1	2	4	6	9	0-¾
1¼	0	0	1	1	2	4	6	1
1½	0	0	0	1	2	3	4	2
2	0	0	0	0	1	1	2	5
2½	0	0	0	0	0	1	1	9
3	0	0	0	0	0	0	1	14

History: 1-2-56; r. and rec. Register, October, 1970, No. 178, eff. 11-1-70; am. (1), Register, October, 1971, No. 190, eff. 11-1-71; renum. from H 62.03, Register, July, 1983, No. 331, eff. 8-1-83.

ILHR 82.04 Building sewers. (1) **PREMISES SERVED.** The interior plumbing of each building shall be entirely separate from and independent of that of any other building. All sanitary, storm drainage or special type drainage system shall be connected, by means of independent connections, with a public sewer, approved private interceptor main sewer or private sewage disposal system.

(2) **MATERIALS.** All building sewers shall be constructed of cast iron, vitrified clay, concrete, asbestos cement, plastic or bituminous fiber pipe or other materials approved by the department. See ss. ILHR 82.19 and

82.24. Corrugated steel pipe may be used for building storm sewer. See limitations, s. ILHR 82.19.

(3) **SIZE.** (a) *Sanitary sewer.* The size of the building sewer shall be determined by the total number of drainage fixture units tributary thereto. The diameter of the building sewer shall be equal to or greater than the size of the building drain. The minimum size of the building sewer from the mains in the street to the property line shall be 4 inches inside diameter. The minimum size of the building sewer beginning at the property line to the building shall be 3 inches inside diameter. The following table shall apply to sanitary building sewers and building drains.

Table 4

Diameter of Pipe (inches)	Maximum Number of Fixture Units		
	¼" per ft. slope	¼" per ft. slope	½" per ft. slope
2.....	4*	9*	12*
3.....	24**	30**	42**
4.....	115	150	210
5.....	270	370	540
6.....	510	720	1,050
8.....	1,290	1,860	2,640
10.....	2,520	3,600	5,250
12.....	4,390	6,300	9,300

* Building drain only; 6 or 8 unit fixtures prohibited.

**Limitation of one 6 or 8 fixture unit fixture.

(b) *Storm sewer.* The required size of building storm sewers, other exterior drains and lateral branches is to be determined on the horizontal projection of roofs, yards and other tributary areas to be drained according to table 11, 11a and 11b. See s. ILHR 82.12 (3) (c). The building storm sewer shall be of a size to accommodate, under normal flow rate capacities, the entire volume of wastes tributary to same. The minimum size of the building storm sewer from the terminal in the street to the property line shall be 4 inches inside diameter. No building storm sewer shall be less than 3 inches inside diameter, inside the property line, or smaller than the building storm drain to which it connects except a decrease in size will be permitted if the increase in slope is sufficient to maintain the volume of flow. Such reduction in size shall be made in a manhole.

(4) **INSTALLATION.** (a) *Gradient.* Building sewers shall, where possible, have a slope of one-fourth inch per foot. In no case shall there be less than one-eighth inch per foot unless a minimum velocity of 2 feet per second is attained throughout the sewer by gravity flow. Between the lot line and the sewer main, or riser pipe therefrom, the sewer shall be laid at a uniform slope not exceeding one-half inch per foot. Building sewers 12 inches or larger in diameter may be installed with a grade equal to main interceptors of the same diameter. Where the main sewer in the street has sufficient depth, or where a lot is 3 feet or more above the established grade line, the building sewer between the lot line and the building shall not exceed a gradient of one-half inch per foot except for a change in elevation which shall be made by the use of 45° fittings.

(b) *Depth.* Sanitary building sewers shall be installed at a depth of not less than 42 inches below finished grade unless authorized by the depart-

ment. Building sewers installed shallower than 60 inches below finished grade shall be provided with frost protection as required by local ordinance for which the method of frost protection has received approval by the department. Building sewers which terminate in a septic tank shall not be less than 18 inches from top of pipe to finished grade.

Note: See appendix A for frostproofing recommendations.

(c) *Riser—main sewer.* A riser from the main sewer may be installed to establish the elevation for the building sewer to insure the proper gradient and depth in accord with pars. (a) and (b).

(d) *Alignment.* All building sewers shall be laid in alignment between fittings. Any changes in grade or direction shall be made with approved "Y's" or long radius fittings. Clipping of pipe or fittings is prohibited.

(e) *Trenching.* All excavations shall be open trench work unless otherwise permitted by local ordinance or accepted by the local inspector.

Note: See ss. Ind 6.06, 6.12 and 6.21 concerning timber requirements for trenches and general safety precautions.

(f) *Stable bottom.* Where the bottom of the trench can be maintained in a stable condition and free of water during time of installation of pipe, the building sewer, depending on the type of material used, shall be bedded and be initially backfilled as hereinafter provided. Grade, as used in this subsection, is defined as the elevation of the bottom of the pipe.

1. Concrete, clay, bituminous fiber, plastic and asbestos-cement pipe. The trench bottom throughout its length shall be excavated to a depth at least 3 inches below the grade elevation except where sand is encountered and shall be brought back to grade with pea gravel, washed stone or crushed stone bedding. The size of the bedding material shall be such that 100% shall pass a $\frac{3}{4}$ inch sieve and 90% retained on a No. 8 U. S. Standard sieve. The bedding shall be shaped to accommodate pipe bells or couplings. Initial backfill on the sides of the pipe and to a depth of 12 inches over the pipe shall be well tamped sand, gravel, crushed stone or excavated material which is neither corrosive nor organic in nature. The material shall be of such size that 100% shall pass a one-inch sieve. Initial backfill shall be placed in increments not exceeding 6 inches in depth and be well tamped for the full length of the sewer.

2. Cast iron soil pipe. Where the trench bottom does not contain stone larger than one inch in size or where bedrock is not encountered, the trench may be excavated to grade. When stone larger than one inch in size or when bedrock is encountered, the trench shall be excavated to a depth at least three inches below the grade elevation and be brought back to grade with a bedding of sand, gravel, or crushed stone of which 100% shall pass a one-half inch sieve. The bedding material shall be tamped in place. The bedding or trench bottom shall be shaped to accommodate the bells of the pipe. Initial backfill on the sides of the pipe and to a depth of 3 inches over the pipe for that part of the building sewer laid on private property shall be well tamped sand, gravel, crushed stone or excavated material which is neither corrosive nor organic in nature. The material shall be such that 100% shall pass a one-inch sieve. For that portion of the sewer in the street, the initial backfill material to a depth of 12 inches over the pipe shall be sand, gravel or crushed stone of

such size that 100% shall pass a one-inch sieve. It shall be placed in increments not exceeding 6 inches and be well tamped.

(g) *Unstable bottom.* Where a mucky or unstable bottom is encountered in the trench, the required dry and stable foundation conditions shall be provided by sheathing driven and left in place to a depth of 48 inches below the trench bottom or to solid foundation at a lesser depth, the removal of wet and yielding material to a depth of 24 inches or to solid material, and replacement of the unstable material with limestone screenings, pea gravel or equivalent material for the bedding under the pipe. The trench bedding shall be shaped to accommodate pipe bells or couplings. In lieu of the foregoing, the required dry and stable foundation conditions may be provided by installation of a longitudinally reinforced concrete cradle the width of the trench and at least 3 inches thick or by installation of a longitudinally reinforced concrete slab the width of the trench at least 3 inches thick and bedding material as provided for in par. (f) 1 and 2. Initial backfill material and its placement shall conform to that specified in par. (f) 1 and 2. All sheathing shall be cut off at a depth of 3 feet or more below the ground surface to prevent heaving due to frost action.

(h) *Access.* When building sewers exceed 100 feet in length cleanouts of the same diameter shall be not more than 75 feet apart on piping up to and including 4 inches in diameter; not more than 100 feet apart on piping 5 to 10 inches in diameter. Manholes shall be constructed for main interceptor sewers 12 inches and larger at intervals not to exceed 200 feet, or at each change of direction of more than 45°. All cleanout openings shall extend to finished grade.

(i) *Industrial waste control.* All building sewers serving manufacturing or industrial processing plants or service stations (gas and oil) which are connected to a public sewer system shall have installed therein a manhole for periodic sewage sampling purposes. The manhole shall be of approved design and shall be located on public right-of-way where possible. When manholes are installed on private property they shall be readily accessible at all times.

1. *Location.* Sampling manholes should be located on public property whenever possible. When located on private property they shall be within 5 feet of the lot line fronting on the public right-of-way and authorized representatives shall be guaranteed the right of access.

2. *Construction.* Sampling manholes shall be a minimum of 36 inches in diameter and constructed in a watertight and substantial manner and may be of concrete, precast concrete, cast iron, bituminous fiber, enamel coated 14 gauge steel, or vitrified clay pipe. Construction details shall follow the general criteria as shown in the following sketch:

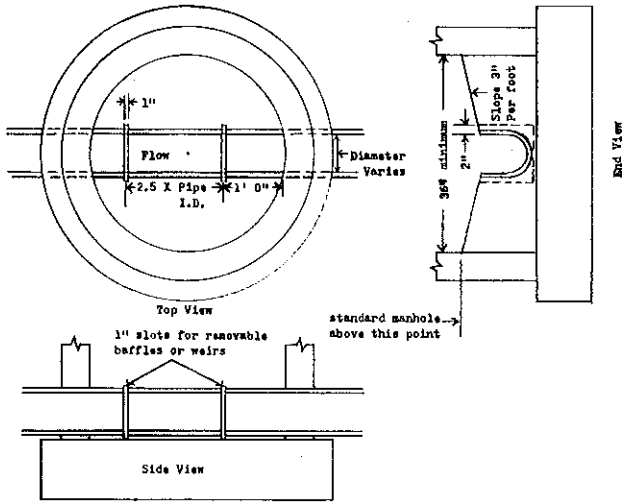

TYPICAL SAMPLING MANHOLE
Section ILHR 82.04 (4) (i)

(j) *Backfill completion.* Due care shall be exercised in placing the balance of the backfill to prevent breakage of the pipe. Large boulders or rock or concrete slabs, or frozen masses shall not be used in the backfill nor shall machinery be operated within the trench until a cover of 6 feet over the pipe has been attained.

(5) **INSPECTION.** The building sewer and/or private interceptor main sewer shall be inspected upon completion of placement of the pipe and before backfilling and tested before or after backfilling. A "T" or "Y" may be provided to permit testing the pipe for leakage or infiltration. Such "T" or "Y" shall be located as near as possible to the point of connection with the street or main sewer. See s. ILHR 82.23.

(6) **CONNECTIONS TO MAIN SEWER.** When a building connection on the street or main sewer is not found within 3 feet of the point designated by the local governing body, or its authorized representative, a "Y" or "T" fitting approved by the department shall be used. The connection shall be set upon or in a carefully cut opening centered in the upper quadrant of the street sewer, and be secured by encasement of the main sewer pipe and the fitting with concrete at least 3 inches thick so as to assure permanency of connection and adequate backing of the street sewer pipe. In lieu of the use of fittings and in the event that the opening cannot be centered in the upper quadrant of the street sewer, a length of the street sewer pipe shall be removed and a "Y" branch section inserted in its place. The joints at the ends of such section shall be encased in concrete at least 3 inches thick. Such connection or insertion shall be made under the supervision of the authorized representative of the municipality.

(7) **SEWER OPENINGS PROTECTED.** The ends of all sewer pipes not immediately connected shall be securely closed so as to prevent the introduction of sand or earth or drainage from an excavation.

(8) **LIMITATIONS AND PROHIBITIONS.** (a) *Location.* The following minimum distances shall be maintained between building sewers and water wells.

1. Sanitary and storm sewers, including sanitary and storm building drains, of cast iron pipe with leaded or neoprene gasket joints—8 feet.

2. Sanitary and storm sewers, including sanitary and storm building drains, other than cast iron—25 feet.

(b) *Use of building sewers.* No person shall connect to a public sewer any building drain or sewer through which is discharged any substance likely to cause undue corrosion, obstruction, nuisance, explosion or interference with sewage treatment processes. See s. ILHR 82.11.

(c) *Storm and clear water connections.* Roof conductors, surface drains, groundwater drains, foundation footing, refrigerator cooling water, storm water drains, drinking fountains, air-conditioning and other clear water drains not described herein shall whenever possible discharge to storm drains or sewers, but they shall not be discharged to a sanitary building drain or sewer or to a private sewage disposal system. Building storm sewers shall not be connected to a building sanitary sewer. The building sanitary sewer and building storm sewer shall be installed as 2 separate pipe lines and shall connect to the appropriate street or main sewer. See s. ILHR 82.12 (1) (b).

History: 1-2-56; am. (10) (b), Register, February, 1957, No. 14, eff. 3-1-57; am. Register, August, 1961, No. 68, eff. 9-1-61; r. and recr. Register, October, 1970, No. 178, eff. 11-1-70; am. (4) (i) 2., Register, October 1971, No. 190, eff. 11-1-71; am. (1), (2), (3) (a) (b), (4) (b), (f) 1, (5), (8) (b), (c), Register, November, 1972, No. 203, eff. 12-1-72; renum. from H 62.04, Register, July, 1983, No. 331, eff. 8-1-83.

ILHR 82.05 Building drains. (1) **ELEVATION.** All building drains shall be brought into the building underground. Building drains shall be installed below the level of the basement floor providing the public sewer, septic tank or private sanitary interceptor main elevation permits. See following sketch.

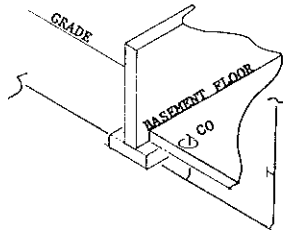

(2) **MATERIALS.** All building drains shall be constructed of concrete, vitrified clay, type L hard temper copper, plastic, cast iron pipe or other materials approved by the department. See ss. ILHR 82.19 and 82.24. The use of concrete, plastic or vitrified clay pipe is permitted only where there is a soil covering of 18 inches or more or where the pipe is covered with 9 inches of soil and a substantial concrete floor having a minimum 3 inch thickness. Where a building drain leaves the building at a point above the basement floor, it shall be constructed of cast iron or type L hard temper copper pipe to a point 5 feet from the inside of the building foundation wall or to such additional distance as necessary to reach undisturbed stable ground.

(3) **SIZE.** (a) *Sanitary.* The size of building drains and building sub-drains shall be determined by the number of fixture units tributary thereto. The minimum size of a building drain and building sub-drain shall be 2 inches inside diameter. The maximum length of the 2 inch un-

derground building drain shall not exceed 20 feet. See ss. ILHR 82.03 (3) table 2, 82.04 (3) (a) and 82.08 (7) (a).

(b) *Storm.* The building storm drain size shall be determined on the total area to be drained thereby and other wastes tributary to the drain. The minimum size of the roof leaders shall be determined from table 5 or shall be calculated using the formula following the table. The size of the building storm drain shall be not less than that specified in tables 11, 11a and 11b. See s. ILHR 82.12 (3) (c).

Table 5

TYPE OF ROOF	ALLOWABLE ROOF AREA IN SQUARE FEET FOR GIVEN SIZE OF INSIDE LEADER					
	2½"	3"	4"	5"	6"	8"
Roof covered with gravel slag or similar material with incline ¼" to 1' or less.....	Up to 1,645	1646 to 2,120	2,121 to 3,780	3,781 to 5,885	5,886 to 8,490	8,491 to 15,125
Same with incline ½" to 1' or more and sawtoothed roofs.....	Up to 1,220	1,221 to 1,770	1,771 to 3,150	3,151 to 4,905	4,906 to 7,075	7,076 to 12,600
Metal, tile brick, slate or similar roofs of any incline.....	Up to 975	976 to 1,415	1,416 to 2,520	2,521 to 3,925	3,926 to 5,660	5,661 to 10,080

(c) *Barrett's formula.* For vertical leaders serving roofs covered with gravel or slag, with an incline not exceeding one-quarter of an inch per foot, allow 300 square feet of roof surface to each square inch of leader opening; for roofs of greater incline or sawtooth roof construction, 250 square feet roof surface to each square inch of leader opening; for metal, tile, slate, or similar roofs of any incline, 200 square feet of roof surface to each square inch of leader opening. This formula using the 300 square feet of area for each square inch of leader opening can also be used for determining the size required for draining yards and other areas. To determine the diameter of the vertical leader required, the following formula can be used:

$$\text{vertical leader diameter} = 1.128 \sqrt{\frac{\text{roof area}}{300 \text{ or } 250 \text{ or } 200}}$$

(4) CONTROLLED ROOF DRAINAGE. (a) *Approval.* Storm water roof drainage systems employing or incorporating special types of equipment, devices, weirs or other methods of controlling or delaying flow volume velocities or capacities for the purpose of minimizing pipe diameter requirements shall receive department approval before installation.

(b) *Design.* The system shall be designed using the area rainfall rate criteria, the formulae applicable to the specific manufacturers roof drain equipment to be installed, other pertinent design data and applicable state plumbing code rules.

(c) *Plans.* Blueprints (isometric or schematic) shall be prepared in triplicate for submission to the department for review. The plans shall contain the entire system layout including the building storm drain and storm sewer. All criteria and data pertinent to the proposed installation shall be included with the plans including other clear water waste tribu-

tary thereto. The installation shall not be revised or deviate from the approved plan without prior authorization from the department.

(5) **BACKFLOW VALVES.** Building drains subject to backflow or backwater at the time of installation shall be provided with adequate backwater valves, installed to prevent interference with the flow and be readily accessible for cleaning.

(6) **OTHER REQUIREMENTS.** Installation of building drains shall also conform to s. ILHR 82.04 (4) (a) as to gradient, s. ILHR 82.04 (4) (f) and (g), (7) and (8); ss. ILHR 82.18, 82.19 and 82.24, insofar as they are applicable and necessary for proper installation.

History: 1-2-56; am. (1), (2) and (3), Register, February, 1957, No. 14, eff. 3-1-57; am Register, August, 1961, No. 68, eff. 9-1-61; r. and recr. Register, October, 1970, No. 178, eff. 11-1-70; am. (3) (a), Register, October, 1971, No. 190, eff. 11-1-71; am. (1), (2), (3) (a), (b) and (6), Register, November, 1972, No. 203, eff. 12-1-72; renum. from H 62.05, Register, July, 1983, No. 331, eff. 8-1-83.

ILHR 82.06 Stacks and branches. (1) GENERAL. (a) *Soil or waste stacks required.* Every building in which plumbing is installed shall have at least 1 vertical stack which shall run as directly as possible from the building drain through the roof.

1. Commercial and industrial type buildings. The furthestmost soil or waste stack connected to the building drain shall extend undiminished in size from the stack cleanout fitting to the roof terminal. Where a building is served by more than 1 building drain connecting to separate building sewers, a minimum 3 inch stack shall be installed to serve each building drain.

2. Residential type buildings. The furthestmost soil stack connected to the building drain shall extend undiminished in size from the stack cleanout fitting to the roof terminal. Where a building is served by more than 1 building drain connecting to separate building sewers, a minimum 3 inch stack shall be installed to serve each building drain.

(b) *Size of soil and waste stacks.* All soil and waste stacks shall be sized according to Table 2 except as follows: No soil stack shall be less than 3 inches in diameter from the highest soil fixture connection to the stack cleanout fitting. When a building contains but one stack, its minimum size shall be 3 inches in diameter.

(c) *Stack offsets.* An offset in a vertical soil or waste pipe with a change of direction of 45° or less from the vertical may be sized as a straight vertical stack.

(d) *Stack base connections.* A long sweep ¼ bend, two ¼ bends, or a wye and 1/8 or 1/6 bend or its equivalent shall be used at the base of all vertical soil and waste stacks.

(e) *Stack and waste pipe extensions.* Any pipe extending from a soil or waste pipe shall be carried full size required to serve the fixture connections and shall be vented or revented to conform with the provisions of s. ILHR 82.03 (1) and (3).

(f) *Soil and waste pipe protected.* No soil or waste pipe shall be installed or permitted outside a building, or concealed in outside walls or in any place where they may be subjected to freezing temperatures unless provision is made to protect them from frost.

(g) *Roof terminals.* Each soil, waste or vent stack shall be increased to at least 4 inches inside diameter or terminate with a department approved frostproof flashing. When the vent is increased to 4 inches inside diameter, the increase shall be made at least 4 inches below the roof and shall extend at least 8 inches to 12 inches above the roof at this point. When the extension is greater than 12 inches or the roof is used for other purposes than weather protection, such extension shall extend not less than 5 feet above the roof. All roof terminals extending more than 12 inches above the roof shall be protected from frost closure.

1. *Location.* The roof terminal if within 8 feet of any door, roof louver, attic vent, window, scuttle or air shaft shall extend at least 2 feet above same. Vent pipes shall not terminate under the overhang of the building. All roof terminals shall be located a minimum of 20 feet from any air intake unit or device.

(2) **HORIZONTAL SOIL AND WASTE PIPE.** (a) *Size and gradient.* All horizontal soil and waste piping shall be sized in accordance with table 2, except that no horizontal waste pipe carrying the discharge of fixtures shall be less than 1½ inches in diameter. The minimum gradient shall be ¼ inch per foot wherever possible; in no case shall the grade be less than ⅛ inch per foot.

(b) *Change in direction.* All changes in direction shall be made by the proper use of 45° wyes, long sweep ¼ bends, 1/6, ⅓ or 1/16 bends, or with fittings producing a like radius, except that single or double sanitary tees may be used on a vertical stack. Short ¼ bends may be used in soil and waste piping where the change in direction of flow is from the horizontal to the vertical and for closet discharge connections.

(c) *Increases and reducers.* Where different sizes of pipes, fittings or combinations thereof are to be connected, proper size increasers or reducers shall be used.

(d) *Fittings.* Fittings in the drainage system shall conform to the type of piping used. Fittings on screwed, threaded or other approved pipe shall be of recessed drainage pattern. All special fittings used in the soil, waste or vent lines shall be submitted to the department for acceptance.

(3) **HANGERS AND SUPPORTS.** Vertical piping shall be substantially supported at 10 foot intervals or floor levels. Provisions shall be made for expansion and contraction of piping and for structural settlement that may affect the piping. Horizontal piping shall be supported at intervals not to exceed 10 feet. Cast iron soil pipe shall be supported at intervals of not more than 5 feet. Supports secured in or against masonry shall be attached with expansion bolts or other approved methods without the use of wood plugs. All piping shall be rigidly secured and supported so that proper alignment will be retained. See s. ILHR 82.21 (3) (a).

(4) **MATERIALS.** All main or branch soil waste pipes within the building which will be intalled aboveground shall be of cast iron, galvanized steel, galvanized wrought iron, lead, brass, DWV, "M", "L" or "K" type copper, borosilicate glass, plastic or other materials which are deemed acceptable to the department for alternate or experimental purposes. Materials installed underground shall be of lead, brass, type "L" or "K" copper, borosilicate glass, cast iron, concrete, vitrified clay, plastic or other materials approved by the department for experimental purposes.

All pipe materials other than cast iron, concrete, plastic or vitrified clay pipe, when installed so as to be embedded in or through concrete, shall be adequately protected by thoroughly applying 2 coats of asphaltum paint or tar paper wrapping or other equivalent means of insulation. For borosilicate glass installed underground, trenching shall be continuous for that portion of the piping which will be below the floor slab. The bottom of the trench shall be constructed so that the pipe will have solid bearing along its entire length. If rock is encountered, the trench shall be undercut 6 inches and backfilled with sand. All buried glass piping shall be covered with polystyrene casing material. All fittings, connections, and joints shall have equally adequate protection. Backfill to a point 12 inches over the pipe shall be earth or sand void of rock, concrete slabs, or frozen masses. No galvanized steel or wrought iron soil or waste pipe shall be laid underground. Underground piping shall also conform to s. ILHR 82.04 (4) (a) as to gradient, s. ILHR 82.04 (4) (f) and (g), (7) and (8), ss. ILHR 82.18, 82.19 and 82.24, insofar as they are applicable and necessary for proper installation. DWV type copper pipe shall not be installed for horizontal piping serving urinals, water closets, bedpan washers, bedpan sterilizers or like fixture.

(5) FUTURE CONNECTIONS. All openings in soil or waste pipes provided for future fixture connections shall be properly connected, vented and sealed. See s. ILHR 82.03 (1) and (3).

History: 1-2-56; am. (2) Register, February, 1957, No. 14, eff. 3-1-57; r. and rec. Register, October, 1971, No. 190, eff. 11-1-71; am. (1) (g), (2) (a), (3) and (4), Register, November, 1972, No. 203, eff. 12-1-72; renun. from H 62.06, Register, July, 1983, No. 331, eff. 8-1-83.

ILHR 82.07 Vents. (1) BACK VENTS. A back vent or continuous vent pipe shall be provided to serve each trap except as otherwise specified in this chapter.

(2) CIRCUIT VENTS. A circuit vent may serve a horizontal soil or waste pipe to which 2 and not more than 8 like fixtures are to be connected. See following sketch. For proper fixture connections, see applicable code sections.

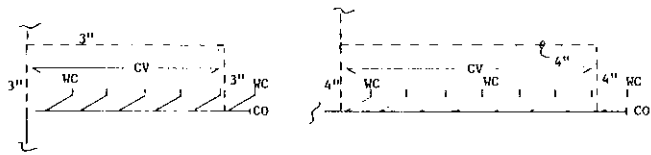

CV = CIRCUIT VENT

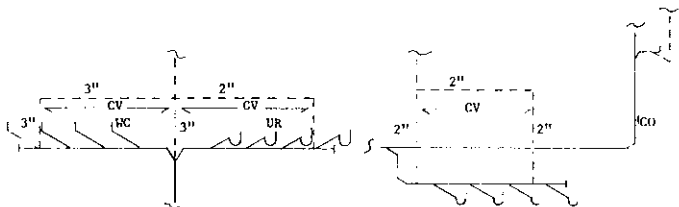

(a) Size. The size of the circuit vent shall be determined by the total number of fixture units connected thereto. This subsection shall not ap-

ply to floor outlet water closets or bedpan washers or fixtures intended for such uses.

(3) CROWN VENT. In no case shall a vent be connected to the crown of a trap.

(4) LOOP VENT. A single island type or isolated fixture may be served by a loop vent when no other method of venting is possible. See following sketch.

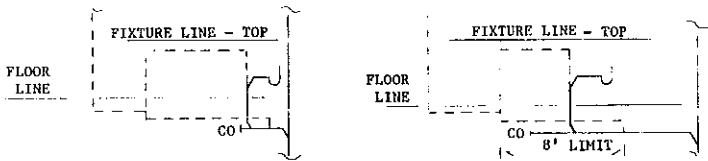

(5) MAIN SOIL OR WASTE VENT. Every building having plumbing fixtures or a plumbing system shall have installed therein at least 1 main soil or waste vent (stack vent) of at least 3 inch inside diameter which shall extend from a soil or waste stack at least 3 inches in diameter to the roof terminal.

(6) MAIN VENT. All vertical soil or waste pipes 3 inches or larger in diameter serving fixtures on 3 or more floor levels shall be provided with a main vent pipe. The size of the main vent shall be determined by the number of fixture units to be served and shall extend full size from the base connection to the point of terminus. See following sketch. See s. ILHR 82.03 (1) and (2).

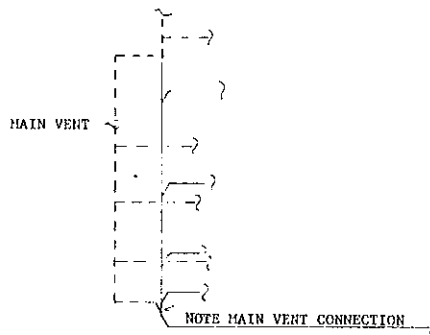

(7) RELIEF VENTS. Where fixtures discharge above a soil or waste pipe served by a circuit vent, each soil or waste pipe shall be provided with a relief vent in the form of a wet or dry vent, taken off ahead of the first fixture, with a diameter of not less than 1½ inches or one-half the diameter of the horizontal soil or waste pipe to which it is connected or whichever is greater. See following sketch.

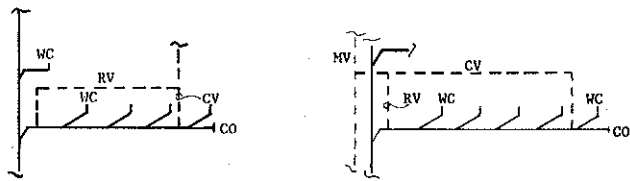

(8) **SUDS VENTS.** Buildings of 3 stories or more having a separate waste stack to serve clothes washers, dishwashers with or without kitchen sinks shall be provided with a suds vent. See following sketch.

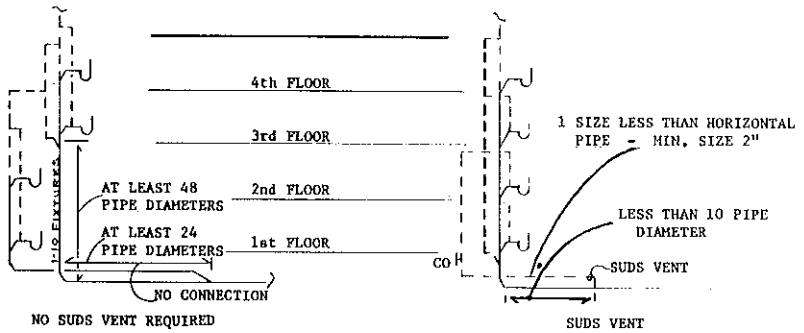

(9) **UNDERGROUND VENT.** Any vent pipe installed underground shall have a minimum inside diameter of 2 inches.

(10) **UNIT VENT.** Two identical fixtures located on the same floor level discharging through the same approved drainage pattern fitting into a vertical soil or waste pipe may be served by a unit vent pipe as hereafter indicated. (Also referred to as a common vent.)

(11) **WET VENT.** Fixtures with a unit value of only one or less may be used to wet vent floor outlet fixtures located on the same floor level as the fixture creating the wet vent.

(12) **YOKE VENT.** All soil and waste pipes served by a main vent in buildings 8 floors or 80 feet or more in height shall be provided with a yoke vent at each 40 foot interval. The size of the yoke vent shall be not less than the size of the smaller pipe to which it connects. The lower end of each such vent shall connect to the soil or waste pipe through a wye below the horizontal branch serving the floor and the upper end shall connect to the main vent pipe through an inverted wye or a tee fitting not less than 3 feet above the floor level. Compute height locations from building drain upward.

(13) **VENT RELOCATION.** Where fixtures are afterwards installed on a soil or waste pipe above existing vent connections to the main soil or waste vent, the vent piping system shall be rearranged to conform to the provisions of this chapter.

(14) **VENT PIPE GRADES AND CONNECTIONS.** All vent pipes shall be free from drops or sags and shall be so graded and connected as to drain back to the soil or waste pipe by gravity. Whenever it becomes necessary to

trap a horizontal vent pipe, it shall be drained back into a waste pipe by gravity.

(15) **VENT CONNECTIONS.** All vent pipes shall be run separately through the roof, be connected to other vent pipes or vent stacks a minimum of 4 inches below the roof, or be reconnected to the main vent pipe not less than 38 inches above the highest floor on which fixtures are installed. All changes in direction from vertical to horizontal on any vent shall be made above the overflow rim of the fixture, but not less than 36 inches above the floor wherever possible. No fitting or fittings for future waste connections shall be placed in any soil or waste pipe above the point of revent connection.

(16) **SPECIAL VENTS.** (a) *Blow-off tanks.* Vents serving blow-off tanks or basins shall not be connected to the vent pipe system serving the sanitary drainage system.

(b) *High temperature steam vents.* Vent pipes serving steam operated sterilizers, cleansing or degreasing equipment, pressing machines or any other apparatus which normally discharges steam into a vent shall be connected to a vent which is separate from the plumbing system.

(c) *Chemical piping.* Vent piping serving waste piping systems conveying acids, caustics, chemical or other similar wastes shall be connected to piping materials approved for such use and shall not reconnect to the plumbing vent piping system, but shall extend separately to the atmosphere.

(17) **ALTERNATE VENTING SYSTEMS.** Design of venting arrangements other than set forth in this chapter shall be submitted to the department for approval prior to installation.

(18) **MATERIALS.** Vent piping materials to be installed aboveground shall be of cast iron, galvanized steel, galvanized wrought iron, lead, brass, plastic, or DWV, "K", "M", or "L" type copper, borosilicate glass or other materials approved by the department. See ss. ILHR 82.19 and 82.24. Materials installed underground shall be of cast iron, type "K" or "L" copper, borosilicate glass, brass, galvanized wrought iron, plastic, or lead. See ss. ILHR 82.19 and 82.24. All pipe materials other than cast iron pipe, when installed so as to be embedded in or through concrete, or other corrosive materials shall be adequately protected by thoroughly applying 2 coats of asphaltum paint or tar paper wrapping, or other equivalent means of insulation. For borosilicate glass installed underground, trenching shall be continuous for that portion of the piping which will be below the floor slab. The bottom of the trench shall be constructed so that the pipe will have solid bearing along its entire length. If rock is encountered, the trench shall be undercut 6 inches and backfilled with sand. All buried glass piping shall be covered with polystyrene casing material. All fittings, connections, and joints shall have equally adequate protection. Backfill to a point 12 inches over the pipe shall be earth or sand void of rock, concrete slabs, or frozen masses.

History: 1-2-56; am. (7) (b), Register, February, 1957, No. 14, eff. 3-1-57; r. and recr. Register, October, 1971, No. 190, eff. 11-1-71; am. (18), Register, November, 1972, No. 203, eff. 12-1-72; renum. from H 62.07, Register, July, 1983, No. 331, eff. 8-1-83.

ILHR 82.08 Fixture drain connections. (1) **GENERAL.** (a) *Installation.* All plumbing fixtures shall be installed in a manner to afford easy access

for cleaning. Enclosures under or around fixtures shall be provided with a circulation of air. Where possible, all piping from fixtures shall be installed within partitions or walls. Access panels shall be provided wherever faucets, valves or traps are concealed. Backgrounds or fixture carrier supports shall be provided for off the floor type fixtures and for other special conditions.

(b) *Drain connections.* Each fixture shall be provided with a water sealed trap installed as near to the fixture as possible. In no case shall the horizontal distance between the trap outlet opening and vent exceed 24 times the inside diameter of the soil or waste pipe serving an above-ground fixture. The total grade of the soil or wastepipe shall not exceed the inside diameter of the pipe. Horizontal waste arms should be avoided wherever possible. See following sketch.

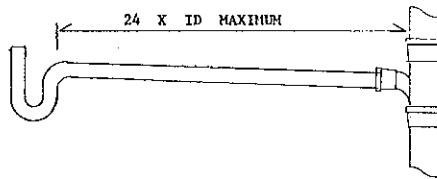

(c) *Vertical distance.* The vertical distance of any waste connection between the top of the fixture strainer or opening to the center line of the horizontal waste pipe shall be as close as possible but shall not exceed 15 inches, except floor drains shall not exceed 24 inches. Floor outlet water closets may have a distance of 36 inches between the water level of the fixture and the center line of the horizontal soil pipe serving same.

(d) *Horizontal distance.* The horizontal distance of any waste connection for a fixture served by a separate trap shall not exceed 12 inches measured from the vertical center line of the trap inlet to the center line of the fixture waste outlet. See following sketch.

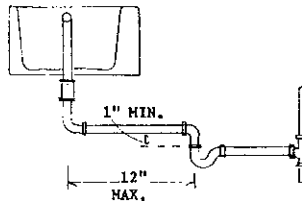

(e) *Stacking fittings.* Fixtures shall not be connected to soil or waste pipes through stacking of fittings unless each fixture trap is served by an individual back vent.

(2) **BACK VENTS, NOT REQUIRED.** (a) *Unit vent.* Floor outlet fixtures such as water closets, bedpan washers, bedpan sterilizers, service sinks and like use fixtures, not to exceed 2, located on the same floor level which discharge within point of vent limitations into a vertically installed combination vented double wye and $\frac{1}{2}$ bend or sanitary tee-cross with no other fixtures discharging into the same pipe above them need not be individually back vented.

(b) *Other fixtures.* Two identical fixtures. Two identical fixtures located on the same floor level discharging through the same approved drainage

pattern fitting may be connected to a vertical waste pipe except that double tapped tees and sanitary crosses shall not be used in any food waste disposer connection.

(c) *Basement and sub-basement fixtures.* Floor outlet water closets, shower receptors, floor drains, service sinks, elevator catch basins or swimming pool sump drains, not to exceed 2 or combination of any 2, connected to an underground building drain or subdrain need not be back vented when the developed distance of the horizontal soil or waste pipe does not exceed 48 times the inside diameter of the pipe. The minimum vent size serving the building drain or subdrain with unvented fixtures connected thereto shall be at least 2 inches inside diameter. Where a vertical soil or waste pipe 3 inches or larger in diameter is involved, the branch connection shall be located 8 feet or more in the direction of flow from the base of such pipe. One fixture shall be the maximum permitted on any unvented horizontal branch. The minimum size branch shall be 3 inches inside diameter. See following sketch.

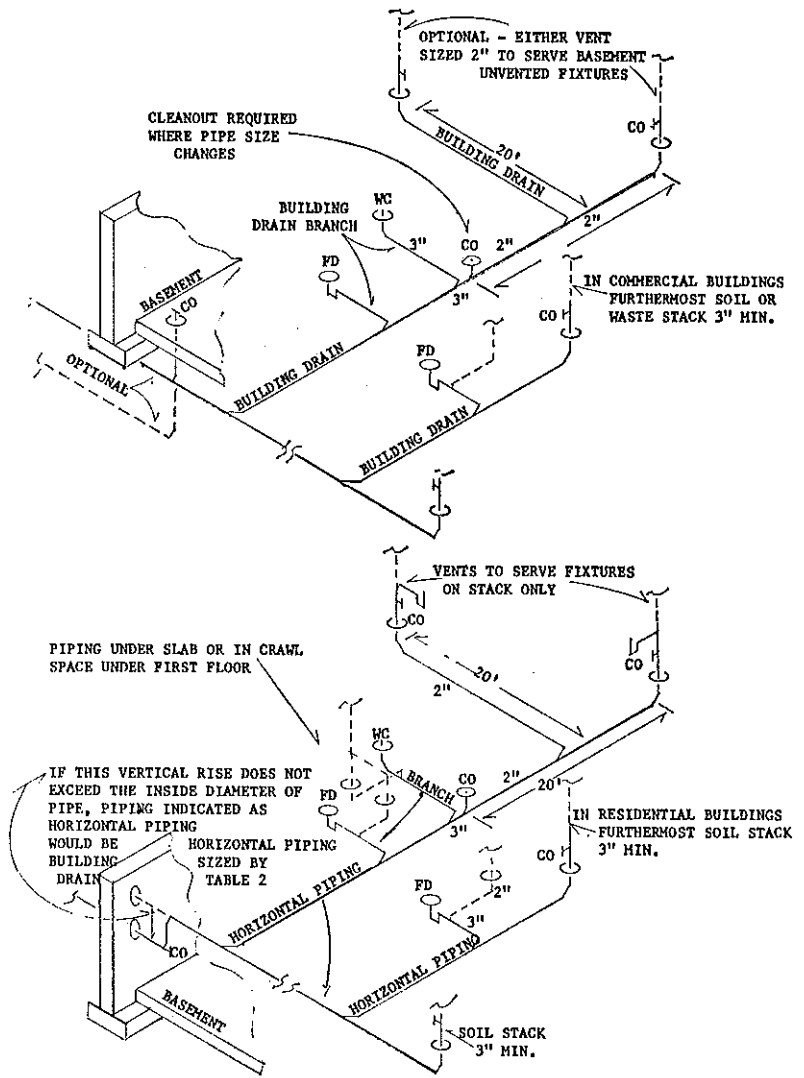

(d) *Kitchen sinks.* Residential kitchen sink fixtures with or without food waste disposal units, not to exceed 3 in number, located directly above one another on individual floors, may connect to a 3 inch diameter vertical waste pipe and need not be individually back vented. Back to back installations are prohibited under this section unless each combination is individually vented. See following sketch.

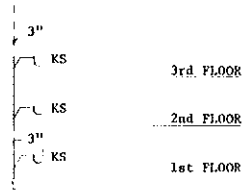

(e) *Other waste connections.* Where separate trapped waste connections from a vented line to each compartment are not installed to serve two-compartment sinks, directional type continuous waste fittings shall be installed. Directional fittings used with a single trap to receive the combined discharge from both sink compartments shall meet all requirements pertaining to venting on the waste discharge side of the trap.

(3) **BAR WASTES.** Bar and soda fountain sinks shall have individual traps and shall connect into a waste pipe which may discharge into an open fixture or receptor through an air-break or air-gap. The total length of the horizontal waste pipe shall not exceed 30 feet. Piping materials may be cast iron, type "L" or "K" copper, galvanized steel, galvanized wrought iron, borosilicate glass, plastic or other materials approved by the department. See following sketch.

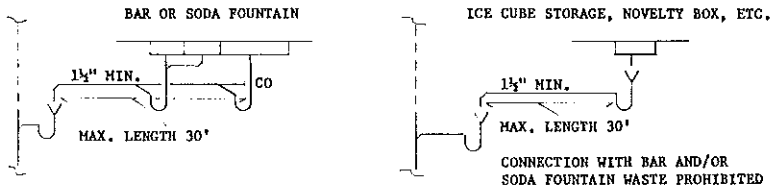

(4) **CLOTHES WASHERS.** (a) *Residential.* Automatic clothes washers shall discharge indirectly into the drainage system through an air-break type connection. Where a standpipe is used for the point of discharge, the length of the standpipe shall be not less than 20 inches measured from the top of the trap inlet to the top of the standpipe. The top of the pipe shall terminate 2 inches below the flood level of the washer drum.

(b) *Commercial.* Large tumble action or drum type clothes washing equipment should discharge into a floor type receptor through an air-break or by other approved methods having a drain adequate in size to rapidly dispose of the waste water. The size of the drain shall be determined by the manufacturers discharge flow rate and s. ILHR 82.03 (2). Interceptor drains shall have a wire basket or other device, removable for cleaning, that will prevent passage into the drainage system of solids 1/2 inch or larger in size, string, rags, buttons or other materials detrimental to the sewerage system. Laundries having wastes containing oils, sand or other solids shall in addition to the above requirements provide an acceptable means of interception for this material.

(5) **DISHWASHING MACHINES.** (a) *Residential.* Residential dishwashing machines shall not be directly connected to any waste piping, but shall discharge its waste through a fixed air-gap installed above the machine. The drain connection from the air-gap may connect to an individual trap

or to a directional fitting installed in the sink tailpiece. For gravity drain dishwasher, see sketch A.

1. The drain from a dishwashing machine shall not be connected to a food waste disposal unit, sink tailpiece or continuous waste on the discharge side of a food waste disposal unit. Two traps shall be used when a sink, food waste disposal, and dishwashing machine are installed. See following sketches.

(b) *Commercial.* Commercial dishwashing machines shall not be directly connected to any waste piping system, but shall discharge its waste separately through a fixed air-gap into an individual trap which is properly vented.

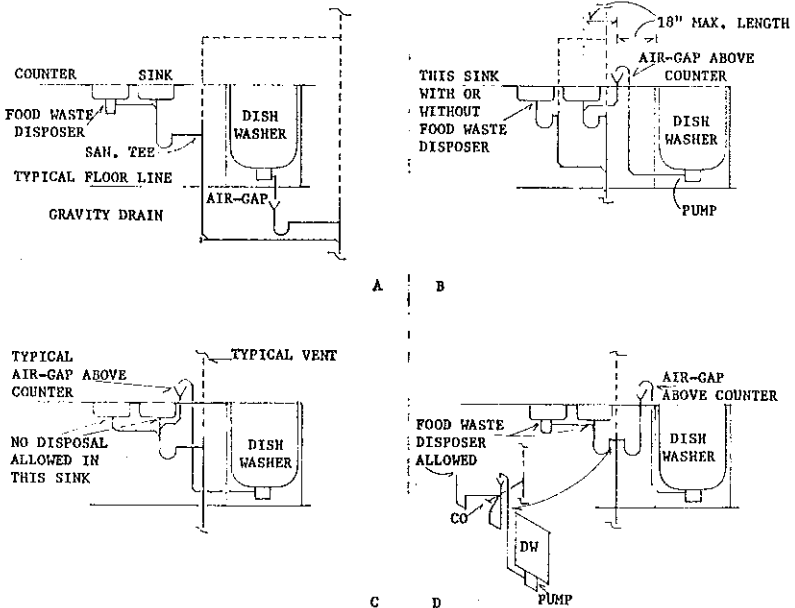

(6) **DRINKING FOUNTAINS.** Refrigerated water coolers may connect to the sanitary piping system.

(7) **FLOOR DRAINS AND BACKWATER VALVES.** (a) *Underground.* All floor drains connecting directly to an underground building drain or building subdrain shall be of cast iron with a water seal of not less than 2 inches and shall have a waterway of not less than 3 inches inside diameter. The unit shall be so constructed, installed and located with the drain inlet in view at all times and so as to provide easy access for cleaning purposes. When such drains are subject to backflow, they shall be equipped with an approved backwater valve.

(b) *Above ground locations.* Floor drains located above ground may have a 2 inch minimum water seal and inside diameter waterway. The maximum length of an unvented horizontal waste pipe shall be no greater than 24 times its inside diameter.

(8) **FOOD WASTE DISPOSERS.** (a) *Household disposers.* The minimum size trap, waste pipe and vent to serve a single food waste disposer shall be 1½ inches inside diameter.

ILHR 82

(b) *Commercial disposers.* Installations shall comply with the requirements of s. ILHR 82.03 (1). For 3 HP or greater capacity or special type units, the manufacturer shall specify the maximum discharge rate of the unit. The size of available waste or building drain and water supply shall be adequate to serve the unit.

(c) *Fittings.* Tapped tees and sanitary crosses shall not be used in any new food waste disposer connection to the waste piping system. Connection of horizontal waste piping serving waste disposer units to vertical piping less than 4 inches in diameter shall be made by the use of a sanitary tee. See following sketch.

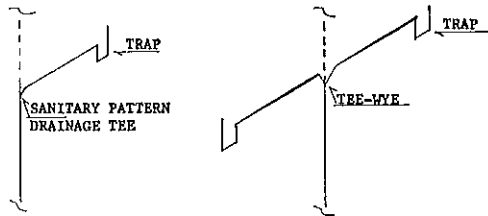

(d) *Prohibited disposer use.* No glass, metal, crockery, stone, gravel, concrete, shellfish shells, plastic, fibrous or other indigestible material shall be introduced into a food waste disposer and be discharged to the drainage system. Eggshells, if in quantities such as might be derived from egg drying and dehydrating plants, may create a serious drainage stoppage and should, therefore, be ground only with sufficient quantities of vegetable materials to cause movement through the drain.

Note: Prior to the installation of food waste disposers in any multiple dwelling, consideration should be directed to the waste piping system for the building, the proposed location and method of connecting the disposers, whether single or two compartment sinks are to be used, the model of the disposer to be installed, as well as any dishwashing machines contemplated and the cold water pipe size and available hydrostatic water pressure.

(9) **FREE STANDING FIXTURES.** Single free standing fixtures such as island sinks, laboratory sinks, etc., may be served by a loop vent and waste pipe type connection. The maximum developed length of the drip section of the loop vent shall not exceed 8 feet. See following sketch.

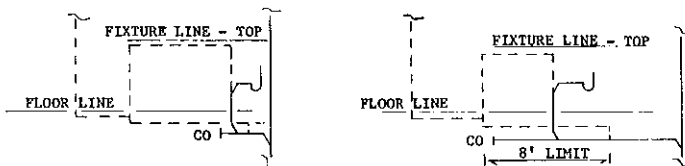

(10) **SPECIAL FIXTURES, EQUIPMENT, DEVICES.** (a) *Special fixtures.* Baptisteries, aquaria, ornamental ponds and fountain basins, industrial wastes and other specialties requiring waste connections or disposition shall be approved by the department prior to installation.

(b) *Bottling establishments.* Bottling plants shall discharge process wastes into an interceptor which will provide for the separation of solids prior to the liquid wastes entering the drainage system.

(c) *Clear water wastes.* Clear water wastes shall discharge to the storm water building drain system through an air-gap.

(d) *Dental cuspidors.* Dental cuspidors when connected to a waste pipe must be effectively trapped and vented as shown in sketch. The length of the horizontal waste pipe between the vent pipe and trap shall not exceed 15 feet. The total fall of the horizontal waste pipe between trap and vent shall not exceed the inside diameter of said waste pipe. See following sketch.

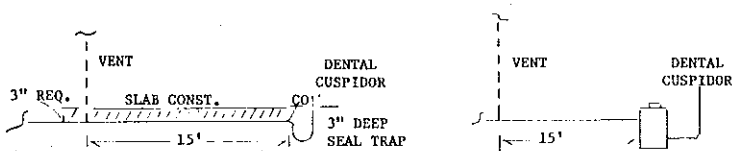

(e) *Drips or drainage outlets.* Appliances, devices, apparatus or appurtenances not regularly classed as plumbing fixtures and not included elsewhere in this code, but which have drips or drainage outlets shall be drained by indirect waste pipes discharging into an open receptacle through either an approved air-gap or air-break method.

(f) *Food preparation equipment.* Indirect waste pipe connections shall be provided for steam kettles, steam tables, potato peelers, coffee urns, egg boilers and other types of equipment. The indirect waste shall discharge through an air-gap or air-break, whichever is applicable, into a trapped and vented receptor.

(g) *Garbage can washers.* The drain outlet receiving the wash from garbage cans shall be at least 3 inches in diameter and shall be provided with a removable basket strainer to prevent discharge of large particles into the building drainage system.

(h) *Hydraulic machinery.* Hydraulic motors, hydraulic elevators or other machinery discharging large quantities of wastes shall be detained in a catch basin or receiving tank of sufficient size and so connected as to prevent the discharge of the wastes under pressure.

(i) *Refrigerated equipment.* The waste piping from refrigerators, refrigerated cases, coils or coolers, ice cube machines, vending machines or any equipment, receptacle or room in which provisions are stored shall not connect directly with any drain, soil or waste pipes. These drains shall be trapped as required to preclude their use as a local vent pipe. The length of the special waste pipe shall not exceed 20 feet. Special waste pipes shall not be less than 1 inch in diameter.

(j) *Slaughter houses.* Slaughtering rooms, meat processing and dressing room drains shall be equipped with approved separators or interceptors which will prevent the discharge into the drainage system of feathers, entrails, blood, manure and other materials likely to clog the drainage system. See s. ILHR 82.11 (4) (grease separators).

(k) *Swimming pools.* Pipes carrying waste water from swimming or wading pools, including pool drainage, backwash from filters and water from floor drains which serve decks around pools shall be installed as an indirect waste. Where the recirculation pump is used to discharge waste pool water to the drainage system, the pump discharge shall be installed as an indirect waste to the building drain or sewer. The regulations for sewer connections as established in ch. H 71 [HSS 171] shall apply to private pools.

(1) *Self-service laundries.* Automatic clothes washing equipment in laundrettes, laundromats or other like public laundry establishments shall have the wastes discharge to a building sewer through a manifold with standpipes served by properly sized and vented water sealed traps. The traps may be individually vented or circuit vented. Acceptable methods of installation are indicated in sketches. The following number of washers shall be the maximum to be connected to each size trap:

Table 6

TRAP SIZE (Minimum)	NO. OF WASHERS (Maximum)
2 inch trap.....	2 machines
3 inch trap.....	3 machines
4 inch trap.....	4 machines

Installation of gutters, troughs, local wastes, indirect manifold waste or other such connections are prohibited installations for the above type equipment. See following sketches.

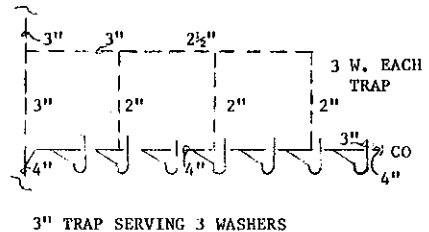
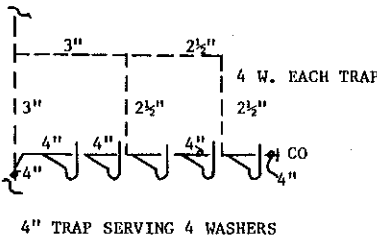
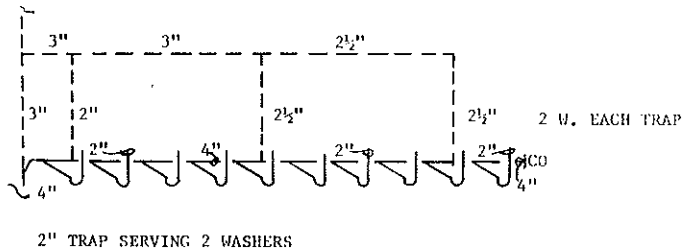
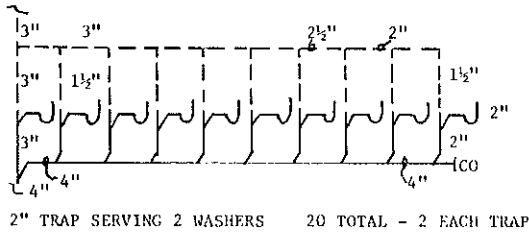
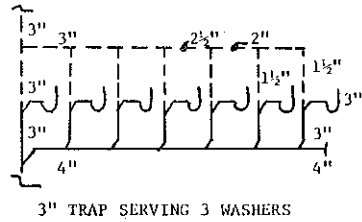
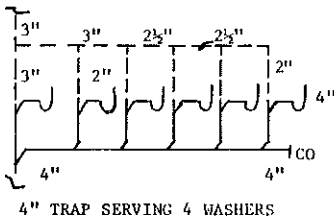

(m) *Vacuum cleaners (central units).* Plumbing connected central vacuum power cleaning units shall be provided with an acceptable air-gap connection in the water intake pipe. The unit shall be connected to the waste piping system through an air-gap or air-break type connection.

(11) **URINALS** (a) *Women.* Urinals for women may be installed as an auxiliary or supplementary fixture. This fixture is not to be used as a substitute for water closets. In all cases, the minimum number of water closets shall be provided.

1. **Enclosure.** The urinal shall be enclosed with a standard size water closet compartment with a door. An instruction card explaining how to use the fixture shall be posted in each such compartment.

2. **Installation.** The fixture shall be installed in accord with all code requirements applicable to water closets. A floor drain shall be installed

within the compartment. Each individual fixture shall be equipped with a hand-operated flush tank, satisfactory foot or hand-operated flush valve or other approved device. The water supply to each urinal shall be protected by an approved type vacuum breaker or other acceptable device.

(b) *Men.* 1. Stall type urinals. Stall type urinals shall be set into the floor and the floor shall be graded toward the fixture. Each urinal shall be flushed individually by an approved foot or hand-operated flush valve or other approved flushing device which is limited to a maximum of 1.5 gallons per flush. The water supply to a urinal (s) shall be protected by an approved type vacuum breaker or other acceptable device. Urinals in batteries shall be spaced not less than 30 inches center to center. The center line of a single urinal shall be at least 16 inches from the nearest side wall or partition. When the space between stall type urinals or a urinal and a side wall is less than 12 inches, such space shall be filled flush with the front and top of the urinal with nonabsorbent material.

2. Wall type. a. Wall hanging men's urinals approved by the department may be installed in all buildings except elementary schools (kindergarten through 8th grade).

Note 1: The definitions and general classifications for schools are found in s. 115.01, Stats.

Note 2: The department recommends that wall hanging urinals for adults be installed at a height between 22 and 24 inches above the floor.

b. Each wall hanging urinal shall be flushed individually by an approved foot or hand-operated flush valve or other approved flushing device which is limited to a maximum of 1.5 gallons per flush. The water supply to a urinal(s) shall be protected by an approved type vacuum breaker or other acceptable device.

c. Wall hanging urinals in batteries shall be spaced not less than 30 inches center to center. The center line of a single urinal shall be at least 16 inches from the nearest side wall or partition.

d. Wall hanging urinals shall be supported by a carrier fitting.

e. Combinations of stall type and wall hanging urinals may be installed.

f. A floor drain shall be located not more than 12 inches from the wall supporting wall hanging urinals. A floor drain shall be provided for each group of 4 or less urinals or a stall type urinal may be used as a substitute for a floor drain.

(c) *Automatic siphon flush tanks.* The use of automatic siphon flush tanks shall be prohibited on stall and wall type urinals.

(12) WATER CLOSETS. (a) *Floor outlet.* One floor outlet water closet may connect to a 3 inch horizontal or vertical soil pipe through a 4 x 3 inch bend. Not more than 2 water closets shall be connected to a 3 inch vertical soil pipe. Offset or 3 x 4 inch closet collar connections are prohibited.

(b) *Back to back floor outlet.* Two water closets located back to back shall be connected to a vertical 3 inch pipe with a 3 inch tee-wye cross. Two floor outlet water closets located back to back may connect to a vertical 4 inch stack through a 4 x 3 inch sanitary cross or through a 4 inch sanitary cross fitting. When fixtures discharge into the same soil

pipe above the water closets, all fixtures shall be properly vented. Back to back floor outlet water closets connecting to a horizontal soil pipe shall be connected by the proper use of 45° wyes, double wyes, tee-wye combinations or with fittings producing a like radius and may be circuit vented or individually back vented. See sub. (1) (c) for vertical limitations.

(c) *Side by side floor outlet.* Floor outlet water closets installed side by side or in batteries shall connect to the horizontal soil pipe through a horizontally installed wye, tee-wye or wye and ¼ bend. The fixtures may be individually back vented or circuit vented. Where circuit vents are used, the size shall be: 3 inch for a battery of 2 to 6 fixtures and 4 inch for a battery of 7 or 8 fixtures.

(d) *Wall outlet floor mounted water closets.* Wall outlet floor mounted type water closet fixtures may be connected to a vertical or horizontal soil pipe through an approved type carrier fitting or 4 inch closet collar. When the soil piping is 3 inches in diameter, the pipe connection shall be increased to 4 inch inside diameter between the fixture and soil pipe fitting connections.

(e) *Back to back wall outlet.* Wall outlet, floor mounted type water closets connected to the same vertical soil pipe shall be installed with a fitting so designed as to prevent cross-flow of wastes or air pressures to the opposite fixture, or through an approved type carrier fitting. Where fixtures discharge into the same vertical pipe on floors above, all fixtures shall be properly vented. Wall outlet, floor mounted water closets may discharge into a horizontal soil pipe through an approved type carrier fitting. The water closets may be individually back vented, served by a 3 inch diameter common vent or a 2 inch diameter common vent increased to 3 inches in diameter a maximum vertical distance of 18 inches above the center line of the fixture opening, with no horizontal offset in the vent pipe below a point 38 inches above the floor line.

(f) *Side by side wall outlet.* Wall outlet floor mounted water closet fixtures installed side by side or in batteries shall connect to the horizontal or vertical soil pipe through an approved carrier type fitting, a wye, tee-wye or wye and ¼ bend connection. The fixtures shall be individually dry vented.

(g) *Off the floor water closets.* 1. Batteries of side by side off the floor type fixtures shall connect to a horizontal or vertical soil pipe through department approved horizontal or vertical carrier type fittings and shall be individually dry vented.

2. Off the floor type water closets installed back to back shall connect to horizontal soil pipe through a department approved type carrier fitting. The water closets may be individually back vented, served by a 3 inch diameter common vent or a 2 inch diameter common vent increased to 3 inches in diameter a maximum vertical distance of 18 inches above the center line of the fixture opening with no horizontal offset in the vent pipe below a point 38 inches above the floor line.

(h) *Stack offsets.* Off the floor type water closets shall be connected to a stack offset through an approved back to back carrier type fitting. The installation shall be served by a unit vent of 3 inches or larger diameter, or may be individually back vented in accord with s. ILHR 82.03 (1), Table 1. Also see s. ILHR 82.06 (1) (c).

ILHR 82

(i) *Multi-story stacks.* Back to back off the floor water closets shall connect to a vertical soil stack through a department approved back to back carrier type fitting. The water closets may be individually back vented, served by a 3 inch diameter common vent or a 2 inch diameter common vent increased to 3 inches in diameter a minimum vertical distance of 18 inches above the center line of the fixture opening with no horizontal offset in the vent pipe below a point 38 inches above the floor line.

(13) BATHROOM GROUPS. (a) *Bathroom group (single).* A single group of bathroom fixtures may be installed without individual fixture vents in a one story building or on the top floor of a building provided that:

1. The water closet is independently connected to a stack 3 inches or larger with no more than 1 D.F.U. connection above. See following sketch.

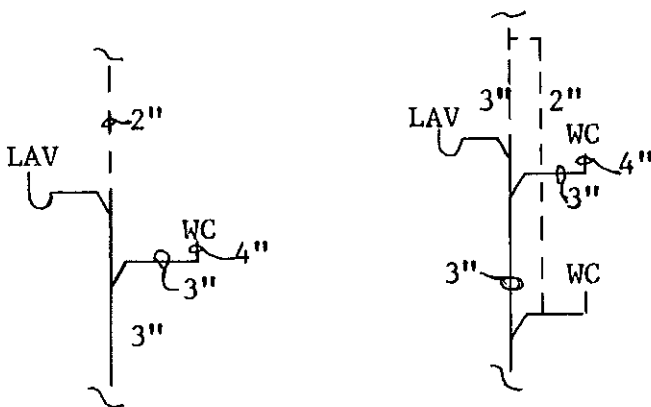

2. The drain from a back vented lavatory serves as a wet vent for a bathtub or shower stall. See following sketch.

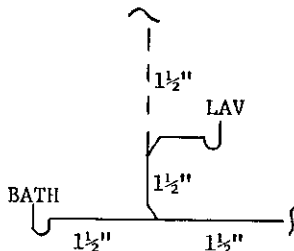

3. Not more than 1 D.F.U. is drained into the 1½ inch vertical vent or not more than 5 D.F.U. drain into the horizontal wet vented pipe. See following sketch.

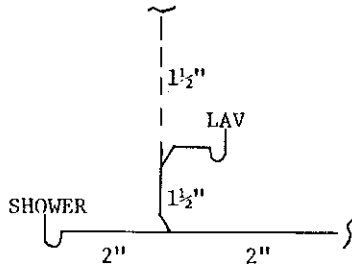

4. The horizontal wet vented pipe shall connect to the stack at or below the same level as the water closet drain when installed on the top floor. See following sketch.

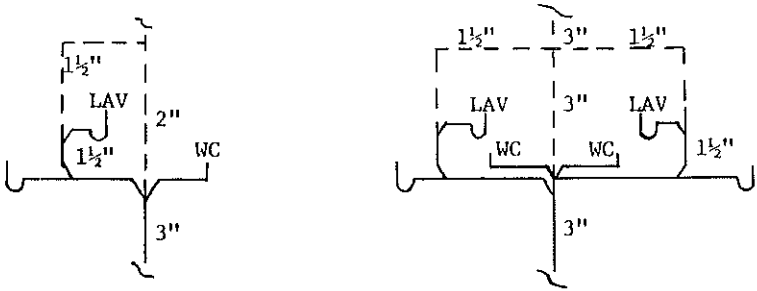

(b) *Double bathroom groups.* Back to back bathroom groups consisting of 2 lavatories and 2 bathtubs or shower stalls may be installed on the same horizontal pipe when served by a 2 inch diameter unit vent provided the water closets (2) connect independently to a 3 inch or larger diameter stack which extends full size without fixture connections above. See following sketches.

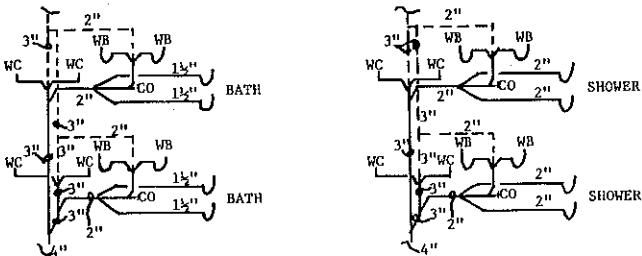

(c) *Other fixtures.* A horizontal soil or waste pipe to which 2 and not more than 8 like fixtures are connected may be vented by a circuit vent. The horizontal soil or waste pipe shall be carried full diameter to the last fixture connection and terminate with a cleanout. See following sketch.

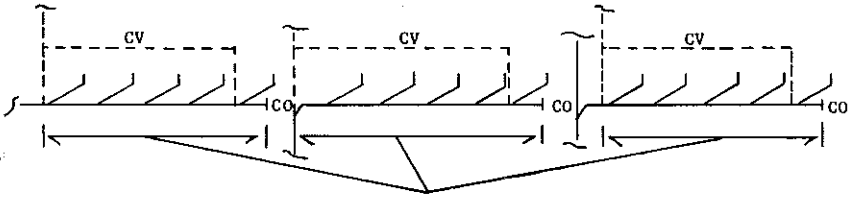

NO CONNECTIONS IN THIS AREA EXCEPT LIKE FIXTURES SERVED BY CIRCUIT VENT.

**NO CONNECTIONS IN THIS AREA EXCEPT LIKE
FIXTURES SERVED BY CIRCUIT VENT**

(d) *Prohibited fixture connections.* There shall be no fixture connection other than the circuit vented fixtures connected to the circuit vented horizontal soil or waste pipe.

(e) *Juvenile fixtures.* Water closets and other fixtures for the use of juveniles shall be of a size and shall be installed at a height suitable for juveniles use. Drain connections shall be provided at height required to serve the fixtures.

(14) **UNLISTED FIXTURES, EQUIPMENT, DEVICES AND APPLIANCES.** For items not included in this section, refer to other applicable sections of this chapter or contact the department for information and proposed installation review.

(15) **INDIRECT WASTE PIPING AND SPECIAL WASTES. SPECIAL EQUIPMENT, INDIRECT WASTE PIPING.** (a) *Piping by plumber.* The indirect waste piping serving any refrigerator, refrigerator case, icebox, ice compartment, vending machine, rinse sinks, steam tables, steam kettles, potato peelers, egg boilers, coffee urns, appliances, devices or appurtenances in which food or provisions are stored or processed, baptismal founts, clothes washers and extractors, dishwashers, dental cuspidors, garbage can washers, appliances, devices or appurtenances such as stills, sterilizers, bar and soda fountains, boiler blow-off basin outlet drains and similar equipment having public health concern shall be installed by licensed plumbers.

(b) *Piping by equipment installers.* Indirect waste piping serving air-conditioning, cooling coils, air-handling condensate waste, expansion tank overflow and equipment serving steam, power, heating, such as flash tanks, boiler to blow-off basins, machinery wastes, process piping and similar waste piping may be installed by the equipment installer.

History: 1-2-56; r. and recr. Register, October, 1971, No. 190, eff. 11-1-71; am. (1) (b), (d), (2) (c), (3), (8) (c), (11) (b) 2. d. e. f. g. h., (12) (e), (g) 2., r. and recr. (5), Register, November, 1972, No. 203, eff. 12-1-72; r. and recr. (11) (b) 2., Register, January, 1979, No. 277, eff. 2-1-79; r. and recr. (11), Register, April, 1980, No. 292, eff. 5-1-80; renum. from H 62.08, Register, July, 1983, No. 331, eff. 8-1-83.

ILHR 82.09 Fixtures. (1) CONSTRUCTION AND DESIGN. All fixtures, appliances, equipment, devices and appurtenances shall be of such design, materials and construction as to comply with applicable standards to insure durability, proper service, sanitation, and so as not to entail undue efforts in keeping them clean and in proper operating condition. All fixtures shall connect directly to the sanitary plumbing system except as

otherwise indicated. Blowout type fixtures of any type may only be installed upon approval of the department.

(2) **FIXTURE OUTLETS.** Outlet passageway shall be free from impairments and of sufficient size to insure proper discharge of the fixture contents under normal conditions. Outlet connections which are directly connected to the plumbing system shall be such that a permanent air and watertight joint can be readily made between the fixture and drainage system.

(3) **MATERIALS.** Fixture shall be made of earthenware, vitreous china-ware, enameled steel or ironware, stainless steel or other approved materials. Wooden trays or sinks with or without metallic lining shall be allowed only in commercial laundries and dye houses where such fixtures are in daily use.

(4) **BATHTUBS.** Bathtubs shall be designed in conformity to applicable standards and shall have waste outlets and overflows at least 1½ inches in diameter. The waste outlet shall be equipped with a suitable stopper or closing device. Bathtubs set in any alcove shall have the side with the longest dimension accessible for entry to the tub.

(5) **DRINKING FOUNTAINS AND DEVICES.** Drinking fountains, coolers and like devices shall not be installed in toilet rooms. All drinking fountains, coolers and like devices shall be separate from other fixtures and be made of earthenware, vitreous chinaware, enameled steel or ironware, stainless steel, anodized aluminum, or other approved material. The bowl shall be so designed and proportioned as to be free from corners so that it may be readily cleaned and so as to prevent unnecessary splashing at the point where the jet stream falls into the bowl. The nozzle shall be of nonoxidizing impervious material and shall have no fouling space or enclosures making cleaning difficult or inducing insanitary conditions. The jet shall be inclined and the orifice shall be higher than the rim of the waste water receiving bowl. The water supply shall be provided with an adjustable valve fitted with a loose key or an automatic self-closing valve permitting regulation of the rate of flow of water. The water supply issuing from the nozzle shall be of sufficient volume and height so that persons using the fountain need not come in direct contact with the nozzle or orifice. To accomplish this, the fountain supply should be equipped with an efficient automatic pressure and volume regulating valve. See s. Ind 52.12 (9), Wis. Adm. Code.

(6) **LAUNDRY TRAYS, SINKS.** Laundry trays and each sink compartment shall be provided with a waste outlet of at least 1½ inch diameter.

(7) **LAVATORIES (WASH BASIN).** Each fixture shall have a waste outlet of at least 1¼ inch diameter. Each multiple type fixture with 18 inches of useable length of a straight-line or circular type shall be considered equivalent to one lavatory (wash basin) for the purpose of determining the water supply and drainage pipe sizes. Each 18 inch interval and each individual lavatory fixture shall be provided with potable water for hand washing.

(8) **SHOWERS.** (a) *Compartments.* Shower compartments shall have at least 1,024 square inches of floor area, measured wall to wall, curb at least 3 inches in height and shall be at least 30 inches in minimum dimensions at any given side or angular shape or as the diameter of a circle

except when a bathtub is used as the shower compartment. The wall area above built-in tub showers and in shower compartments shall be constructed of smooth, noncorrodible, nonabsorbent, waterproof materials to a height of at least 6 feet above the floor level. The walls shall form a watertight joint with each other and with either the tub, receptor or shower floor. The floor of the shower or compartment shall be of slip-resistant finish. Preformed and prefabricated units shall comply with this subsection.

(b) *Waste outlet.* Waste outlets serving single showers, other than those in bathtubs, shall be at least 2 inches in diameter. When gang showers are to be served, the minimum drain outlet shall be 3 inches in diameter. Strainer perforations or slots shall be no smaller than $\frac{1}{4}$ inch. Where gang showers are installed, the waste outlet should be so located and the floor so pitched and waste water from one shower head does not flow over the floor area serving another shower head.

(c) *Safing.* All shower stalls, shower rooms, floor setting service sinks or receptors, sunken bathtubs or other like fixtures shall be provided with 4 pound sheet lead asphaltum coated, compositite, copper, saraloy or other approved safing material beneath the entire fixture or room and upward along the sides to a minimum of 6 inches above the curb or maximum water level of the fixture. The corners shall be safed to a height of 6 feet and at least 3 inches in each direction from the corners. The safing shall be properly drained. Unitized receptors, manufactured floor setting service sinks, shower receptors, bathtubs and installations directly over an unexcavated portion of a building are exempt from safing requirements.

(d) *Shower drains and floor drains.* Shower drains and floor drains shall be considered a fixture and shall be provided with an approved strainer.

(9) **URINALS.** (a) *General.* Urinals shall be made of material impervious to moisture and which will not corrode under the action of urine, be of such design, materials and construction that they may be properly flushed and kept in a sanitary condition. If cast iron is used in the construction of urinals, it must be enameled on the inside and coated with durable paint or be enameled on the outside. No sheet iron urinals will be permitted. Only individual urinals shall be used in public buildings and places of employment. Such individual urinals shall be of vitreous china or stainless steel and shall be equipped with an automatic flushing device.

(10) **WATER CLOSETS.** (a) *General.* All water closets shall be designed to meet specification standards for land use fixtures. They shall hold a sufficient quantity of water and be of such shape and form that no fecal matter will collect on the surface of the bowl. All water closet bowls shall be equipped with adequate flushing rims so as to flush and scour the bowl properly when discharged. Water closet seats shall be of wood or other nonheat absorbing material. See Wis. Adm. Code s. Ind 52.59 (2).

1. In public buildings, places of employment, and all other public places except in apartments and guest rooms in hotels and motels, the water closets shall be of the elongated or extended lip design.

2. Except in apartments and guest rooms in hotels and motels, water closet seats shall be open front seats without cover.

3. Water closet seats in guest rooms in hotels and motels shall be open front with or without cover.

(b) *Side inlet water closet bowls.* New water closet installations shall not be equipped with side inlet openings.

(c) *Fixture flushing.* Each water closet shall be individually equipped with an acceptable flush tank and fittings with an approved flushometer valve. All flush tanks, flushometer or automatic flushing device shall be readily accessible for maintenance and repair. Ballcocks shall be of the anti-siphon type.

(d) *Prohibited water closet fixtures.* It shall be unlawful to install and/or maintain pan, plunger, offset washout, washout, long hopper, frostproof and/or other water closets having invisible seals or unventilated spaces or walls not thoroughly cleansed at each flushing.

(11) **OVERFLOWS.** (a) *Design.* In any fixture which is provided with an overflow, the waste outlet shall be designed and installed so that the standing water in the fixture cannot rise in the overflow when the stopper is closed, nor shall any water remain in the overflow when the fixture is empty.

(b) *Connection of overflows.* The overflow from any fixture shall discharge into the drainage system on the inlet or fixture side of the trap provided that the overflow from a flush tank serving a water closet or urinal shall discharge into the fixture served.

History: 1-2-56; r. and recr. Register, October, 1971, No. 190, eff. 11-1-71; am. (5) and r. and recr. (10) (a), Register, November, 1972, No. 203, eff. 12-1-72; r. and recr. (8) (a), r. (12), Register, January, 1979, No. 277, eff. 2-1-79; renum. from H 62.09, Register, July, 1983, No. 331, eff. 8-1-83.

ILHR 82.10 Traps and cleanouts. (1) **TRAP SIPHONAGE.** Every fixture trap seal shall be protected to prevent siphonage or back pressure by insuring air circulation with an approved vent in compliance with this code. In no case shall a vent be connected at the crown of a trap.

(2) **TRAP CONSTRUCTION.** (a) *Design.* No trap which depends upon the action of movable parts for its seal shall be used. No trap shall be used which depends upon concealed interior partitions for its seal unless such interior partitions are made of indestructible material. No trap shall be used which in case of defect would allow the passage of sewer air. No rubber or wicking packed slip joint connection shall be installed on the sewer side of a fixture trap. Slip joint waste connections on the sewer side of the trap shall be ground faced or equal and shall not be concealed or enclosed.

(b) *Cleansing.* Every trap shall be self-cleaning. Floating and sedimentary solids in the seal of the trap shall be removed by a normal discharge from the connected fixture. Uniform diameter traps shall be considered self-cleaning.

(c) *Material.* The material for traps shall be either vitreous china, clay, lead, brass, copper, borosilicate glass, cast iron or malleable iron. Cast iron traps shall be coated on the inside and outside with rustproof coating.

(d) *Depth of seal.* The water seal of all fixture traps shall be at least 2 inches. A deep seal trap shall have a water seal of 4 inches.

(e) *Approval.* Every trap, P.O. plug and trap extension tubing shall have the maker's name, or registered trademark, cast or stamped upon the exterior surface thereof. Traps varying from standard design shall have the approval of the department before being used in any installation.

(3) TRAP INSTALLATIONS. (a) *Setting of traps.* All traps shall be so located as to be accessible, rigidly supported and set true with respect to their water level and so located as to protect their seals, and where necessary, shall be protected from freezing and evaporation.

(b) *Traps where prohibited.* No fixture shall be double trapped and there shall be no traps at the base of soil or waste stacks.

(c) *Bath traps.* Drum traps not less than 4 inches in diameter and having a seal of not less than 2 inches may be used under all bathtubs wherever practicable. The horizontal distance between the vertical center line of the drum trap inlet to the center line of the fixture waste outlet shall not exceed 12 inches.

(d) *Deep seal traps.* Deep seal resealing traps of the centrifugal self-scouring type may be used when it is impractical to provide a proper back vent. So far as practical a free circulation of air shall be provided. Traps of this type shall not be permitted in new construction or reconstruction.

(4) PROHIBITED TRAPS. Bell, pot, and bottle traps, $\frac{3}{4}$ "S", full "S" type traps, traps fabricated from fittings, crown vented traps and traps constructed of masonry are not permitted.

(5) CLEANOUTS. (a) *Size.* Cleanouts shall be sized according to table 7. See following table and sketch.

Table 7

IRON BODY FERRULES WITH BRASS SCREW PLUG

Pipe Size (inches)	Dimensions in inches						Weight without plug (pounds)	
	C	F	I.P.S. Tapping	Tapping depth of G	K	R	'XH'	'SV'
2-----	--	3½	1½	½	2	1¼	1½	1¼
3-----	--	3¾	2½	9/16	3	1¾	2¼	2
4-----	--	4¼	3¾	9/16	4	1¾	4	3
5-----	--	4¼	4	¾	5	1½	5	3¾
6-----	--	4¼	5	¾	6	1½	6	4¼
8-----	7½	4¾	6	¾	8	1¾	12	9
10-----	7½	4¾	6	¾	10	1¾	20	15
12-----	7½	5¼	6	¾	12	2¾	28	21
15-----	7½	5¼	6	¾	15	2¾	43	30

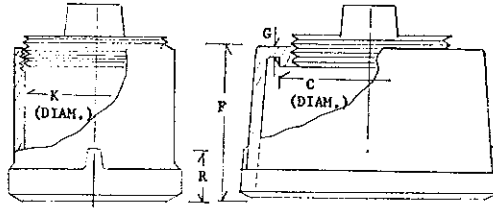

(b) *Building drain.* A cleanout with brass screw cover or other type approved by the department shall be provided at a point where the building drain leaves the building. This cleanout shall be extended from the building drain with a cast iron soil pipe to the surface of the finished floor or grade and wherever practical shall be not less than 2 inches above the finished floor or grade. An additional cleanout located at a point 28 to 30 inches above the floor shall be provided in all soil and waste stacks.

(c) *Toilet and washrooms.* Cleanouts shall be provided in connection with batteries of water closets, urinals, wash basins, sinks and showers, at such points that all parts of the branch waste and soil pipes may be reached conveniently for cleaning or removal of stoppages.

(d) *Sink wastes.* Waste pipes from sinks or other similar fixtures discharging greasy wastes shall have sufficient accessible cleanouts spread over their entire length.

(6) **TRAP CLEANOUTS.** All fixture traps shall be so designed and installed that stoppages may be removed. All small fixture traps shall be provided with cleanouts of the screw plug or removable dip type. Where the "U" or dip is removable the coupling nut on the discharge side shall be within the dip of the trap. Traps for urinals rising from the floor and traps serving shower baths and floor drains, when inaccessible, shall be so installed as to make the removable inlet serve as a cleanout.

(7) **CONSTRUCTION.** The bodies of cleanout ferrules shall be made of cast iron or brass and shall extend not less than $\frac{1}{4}$ inch above the hub receiving it. Brass screw caps for cleanouts shall be in accord with table 8 and the following sketch. Solid head brass cleanout plugs shall be used when the cleanout plug is drilled and tapped to provide access cover extensions or escutcheons. The depth of the drilling and tapping shall not exceed 75% of the thickness of the cleanout plug head. The hole and tapping shall not penetrate the cleanout plug. See following sketch. Adequate inverted or countersunk sockets may be substituted for square or hexagonal heads where applicable. The ferrules when constructed of brass shall be at least $\frac{3}{16}$ inch in thickness and when constructed of iron the same weight per foot as for cast iron soil pipe. The screw thread shall have at least 5 threads of iron pipe size. A brass plug of standard pipe size shall be used where threaded metal drainage fittings serve as cleanout openings. Plastic cleanout plugs shall be used where plastic drainage fittings serve as cleanout openings.

Table 8
SCREW PLUGS (BRASS) 'XH' and 'SV'

Size (inches)	Dimensions in inches						Across flats H ¹	L (see note)	Weight (pounds)
	A	B	C	D	E	G			
1½	½	½	¾	1-5/16	5/32	¼	1	5/32	¼
1½	¾	¾	¾	1½	3/16	¼	1	3/16	¾
2.....	¾	¾	1	2	3/16	¼	1½	3/16	½
2½	¾	¾	15/16	2¾	3/16	5/32	1¼	¼	¾
3.....	¾	1	1-15/16	2-15/16	3/16	5/32	1-5/8	¼	1½
3½	¾	1	1¼	3-7/16	¼	3/16	1¾	¼	1½
4.....	¾	1	1¾	3-15/16	¼	3/16	2	5/16	2
5.....	1	1	1-15/16	4-15/16	5/16	7/32	2¾	¾	3½
6.....	1	1	1-7/8	5-15/16	¾	¼	2¾	¾	4¾

¹ Heads of plugs shall be either square or hexagonal. Dimension H is taken between opposite sides of either style used.

Note: When thread gauge is screwed tightly on plug by hand, large end of gauge shall be the distance "L" plus or minus 1½ turns, from surface of plug.

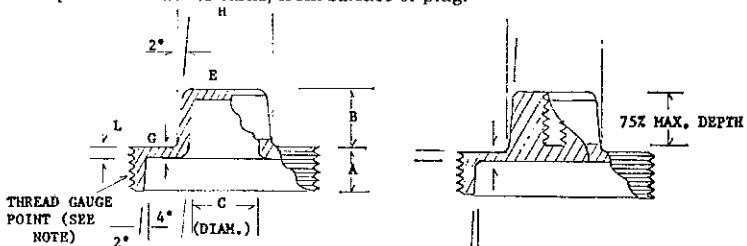

History: 1-1-56; am. (1), (4) and (5), Register, February, 1957, No. 14, eff. 3-1-57; r. and rec., Register, October, 1971, No. 190, eff. 11-1-71; am. (3) (d), (5) (a) and (7), Register, November, 1972, No. 203, eff. 12-1-72; renum. from H 62.10, Register, July, 1983, No. 331, eff. 8-1-83.

ILHR 82.11 Interceptors, sumps, ejectors and special and industrial wastes. (1) **INTERCEPTORS.** (a) *Where required.* Any waste materials other than domestic wastes which upon discharge may congeal, coagulate or accumulate in drains or sewers, thereby creating stoppages retarding normal flow rates, or which may retard or interfere with normal sewage treatment processes, or which may pass through the treatment processes so as to pollute the watercourse receiving the treatment plant effluent, or which may create explosive, flammable, noxious, toxic, or otherwise hazardous mixtures of materials, or which may damage, destroy, or deteriorate sewers, or piping structures and/or materials, shall be directed to an interceptor or other approved device capable of separating with proper care and maintenance, all harmful, dangerous, or deleterious materials from regular sewage materials retaining the deleterious materials in the interceptor or device to facilitate periodic removal and/or treatment. See ch. Ind 8, Flammable Liquids.

(b) *Private systems.* Where any above indicated wastes from any plumbing system are not discharged into a public sewer, such wastes shall be treated or disposed of in compliance with methods approved by the state department having jurisdiction and shall be installed so as not to endanger any water supply that is or may be used for drinking, culinary or bathing purposes, or which may create a nuisance, insanitary conditions or water pollution.

(c) *Velocity control* Interceptors shall be designed, sized and installed so that flow rates shall be developed and maintained in such a manner that solid or floating materials of a hazardous or deleterious nature will be collected in the interceptor for disposal.

(d) *Maintenance*. All devices installed for the purpose of intercepting, separating, collecting, or treating harmful, hazardous or deleterious materials in liquid or liquid-borne wastes shall be properly operated and shall be cleaned of intercepted or collected materials, or any residual from treatment at such intervals as may be required to prevent their introduction into the plumbing, drainage or sewerage systems.

(e) *Service reassembly*. Any fixed orifice, vent or trap shall remain intact and shall not be removed or tampered with except for cleaning purposes. After service, all parts of the interceptor, collector or treatment device, such as baffles, weirs, orifice plates, channels, vents, traps, tops, and fastening bolts or screws shall be replaced in proper working position.

(f) *Location*. Interceptors, sumps and waste treatment devices shall be located so service, maintenance, repair and inspection may be readily accomplished. No interceptor or treatment device shall be surrounded or covered as to render it inaccessible for service or inspection. Any interceptor having its top more than 6 feet above the surrounding floor, or which has less than 30 inches clear space above its top or which has permanent equipment placed above or about it in a manner so as to prevent ready and repeated cleaning or inspection shall be deemed inaccessible and shall not be accepted.

(g) *Disposition of retained materials*. Harmful, deleterious or dangerous materials, after removal from any interceptor, sump or treatment device, shall not be introduced into any drain, sewer or natural body of water without approval of state departments having jurisdiction.

(2) CATCH BASINS. (a) *General*. Catch basins shall be constructed in a water-tight and substantial manner of concrete masonry, brick masonry, concrete block masonry, precast reinforced concrete, cast iron, bitumastic enamel coated 12 gauge steel, vitrified clay or other materials approved by the department.

(b) *Design*. All catch basins shall be a minimum of 36 inches inside diameter and shall have a minimum depth of 48 inches. The outlet shall be provided with cast iron sanitary tee or inverted wye connection not less than 4 inches inside diameter and shall be submerged not less than 18 inches below the flow or waterline and shall terminate not less than 18 inches above the bottom of the catch basin. A cleanout shall be provided in the horizontal pipe. The catch basin shall have a fitted removable concrete, cast iron or steel cover of a thickness and strength to sustain weight or traffic to which it will be subjected. No catch basin shall be installed within 25 feet of any water well. See following sketch and s. ILHR 82.12 (6).

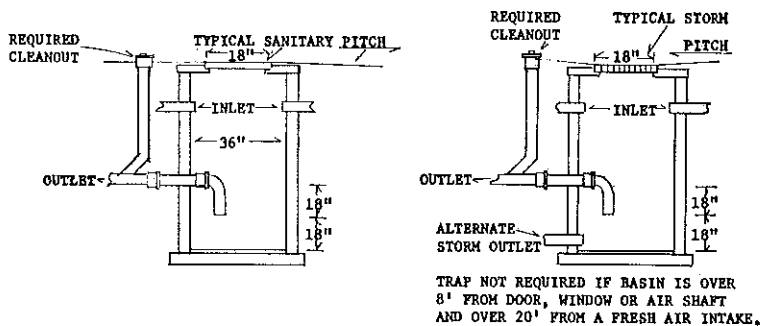

(c) *Catch basin.* All catch basins shall be constructed according to their intended use. When connected to a sanitary sewer, catch basins shall be located and designed to exclude storm and other clear water wastes.

(3) **CREAMERIES, DAIRIES AND MILK PASTEURIZING PLANTS.** (a) *Creamery and dairy wastes.* Waste piping from milk vats, sterilizers, or other receptacles or sinks used in creameries and milk houses shall be of the same size and material as waste piping from general use sinks. Creamery and milk house wastes shall discharge either onto a watertight floor having properly trapped floor drain connections discharging into the soil or waste systems or into a properly constructed sump or interceptor.

(b) *Milk pasteurizing plants.* Pasteurizing plants and/or milk bottling establishments shall direct all drains and wastes from any floor on which processing is conducted into an interceptor. The interceptor shall separate any harmful or deleterious materials before discharging its normal wastes to the plumbing system or building sewer.

(4) **GREASE INTERCEPTORS.** (a) *Where required.* All new or altered installations serving institutions or commercial establishments in which grease, fats, oils, or like waste products of cookery or processing, or in which grease, fats or oils are wasted in connection with utensil, vat, dish or floor cleaning processes shall install grease interceptors acceptable to the department. All waste lines and drains carrying oil, grease or fats in the above type buildings shall be directed to one or more interceptors before connecting to the plumbing system.

(b) *Existing installations.* The department may require the installation of grease interceptors in existing installations where either the public or private sewers and/or drains become stopped due to congealed grease, either reducing or completely filing the waterway of the sewer or waste piping from the fixture or establishment from which greasy wastes are discharged.

(5) **ACCEPTANCE AND TESTS.** (a) *Tests.* The department shall require such tests on grease interceptor as may be deemed necessary to determine for each make, model or type, its grease collecting efficiency, the maximum effective grease capacity, the flow rate and characteristics of installation. These tests shall be performed in a laboratory acceptable to the department. If the size, type or design of an interceptor is beyond the testing facilities of available laboratories, the interceptor may be set up in a field installation under the direction of the department, and tests shall be conducted under supervision and control of departmental per-

sonnel. The department may review tests conducted by other laboratories, and if testing procedures and results are adequate and satisfactory to the department, the tests in whole or part thereof may serve in lieu of either laboratory or field tests, as above indicated.

(b) *Minimum required features.* 1. Flow rate. The minimum acceptable flow rating of any interceptor shall be 10 gallons per minute.

2. Materials and covers. Grease interceptors shall be constructed of durable, corrosion resistant, gastight and watertight materials and shall have gastight and watertight covers securely fastened in place.

3. Flow rate related to connected capacity. The total capacity measured in gallons of all fixtures and devices discharging to the interceptor shall not exceed $2\frac{1}{2}$ times the flow rate of the interceptor measured in gallons per minute.

4. Grease holding capacity as related to flow rate. The grease interceptor holding capacity in pounds shall not be less than double the value of the interceptors accepted flow rate measured in gallons per minute. (i.e. 2 gpm = 4 lbs.)

5. Flow controls. Devices which control the rate of flow through an interceptor shall be installed so as to be readily accessible for inspection, service or cleaning. If of the orifice type, each one shall be installed as close to the tailpiece of the fixture or machine served as fittings and available connections will allow.

6. Multiple connections to a common interceptor. Flow controls shall be installed in the waste branch leading to each fixture and shall be so rated that the combined flow from all combinations of discharge will not develop either sufficient static or velocity head so the established flow rate of the interceptor can be exceeded.

7. Prohibited locations and types. No water cooled grease interceptor shall be installed. No grease interceptor shall be located where surrounding temperatures, under operating conditions, are less than 40° F.

8. Flow control vents. Flow controls of the orifice type shall be vented in the sanitary plumbing system or be extended through the roof or through an outside wall. If extended through the roof or outside wall, the minimum size increaser shall be 2 inches. If vented through an outside wall, the vent shall terminate in a tee fitting whose run is vertical and above the normal passing traffic. See following sketch.

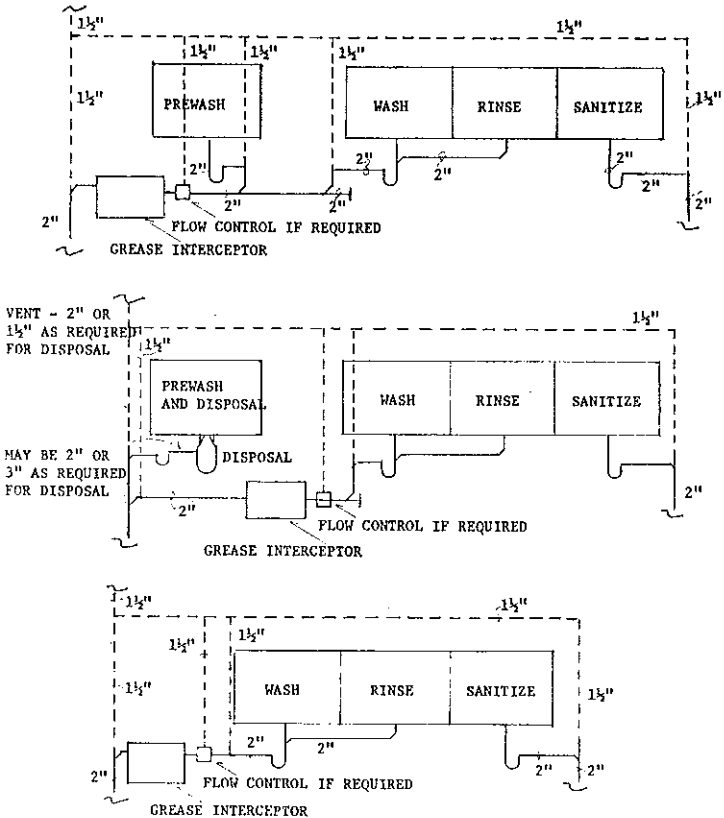

9. Prohibited discharge. No grease interceptor shall receive the discharge from a food waste grinder device.

(6) LAUNDRIES. (a) *Commercial laundry.* Each commercial laundry shall be equipped with an interceptor.

(b) *Design.* Laundry interceptors shall be equipped with a removable wire basket or other acceptable removable screening apparatus which will prevent the discharge of materials, such as lint, string, rags, buttons, etc., into the drainage system.

1. Laundry waste containing oils, sand or other solids shall, in addition to the above requirements, provide an acceptable method of interception for these materials as required elsewhere in this chapter.

2. If baskets are used, the minimum diameter of a laundry interceptor shall be 24 inches. The basket shall be of $\frac{1}{4}$ inch mesh on the bottom and sides with a depth of not less than 24 inches. The basket shall be installed so as to cover the outlet of the interceptor. The outlet shall be not less than 12 inches above the bottom of the interceptor. Duplicate baskets or screening apparatus should be provided for convenience in cleaning and maintenance.

(7) OILS AND FLAMMABLE LIQUIDS INTERCEPTOR. (a) *Volatile liquids.* All buildings discharging oily and/or flammable wastes to the sewer shall

have one or more interceptors installed into which all such wastes shall be led. These normally include all commercial, storage or repair garages; gasoline stations with grease racks, grease pits, or wash racks; all auto laundries; and all factories which have such wastes as a result of manufacturing, storage, maintenance, repair or testing processes.

(b) *Separation of liquids.* 1. Site constructed separators. Oil separators constructed on the site shall have a depth of at least 24 inches below the invert of the discharge drain connected thereto. The outlet opening of the separators shall have a water seal of at least 18 inches.

2. Commercial interceptors. Commercial oil separators shall have sufficient capacity and be properly installed and maintained so they will serve the purpose for which intended. Iron oil separators shall be made of not less than 12 gauge copper bearing steel or cast iron. Manufacturers' ratings will be accepted with the approval of the department.

(8) DESIGN. (a) *Motor vehicle occupancies.* In automotive service stations, automotive repair shops and public garages where not more than 4 vehicles are both serviced and stored, separators shall have a minimum capacity of 6 cubic feet with 1 cubic foot added for each vehicle up to 10 vehicles. Where more than 10 vehicles are serviced, separator capacity shall be based on net capacity of 2 cubic feet for each 100 square feet of surface to be drained into the separator, with a minimum of 6 cubic feet.

(b) *Other occupancies.* In other buildings where oil or other flammable liquids are stored or used, no physical connection or internal arrangement that could permit the accidental or deliberate introduction of such materials directly or indirectly into the sewer system will be permitted. Where substances might overflow by spillage or other circumstances not caused by a direct connection of the plumbing system, protective dikes or similar devices shall be provided to prevent such substances from reaching the public sewers.

(c) *Oil storage.* Each separator shall have an oil storage tank available for storing the residue from the separator.

(d) *Sand interceptors.* Commercial establishments which require sand or similar interceptors for heavy solids shall be so designed and located as to be readily accessible for cleaning and shall have a water seal of at least 18 inches.

(e) *Venting.* Oil interceptors and separators shall be so designed that they will not become air bound if closed covers are used. Each interceptor or separator shall have an individual 3 inch vent extending from the top of the device to the outside atmosphere at a point at least 12 feet above street level. A fresh air inlet shall be provided from the drain line at the inlet side of the separator to the outside air at a point at least 12 inches above grade level. See s. Ind. 8.22.

(f) *Accessibility and maintenance.* Each separator, interceptor or similar device shall be so installed as to be readily accessible for removing the cover for servicing and for maintenance. All units shall be maintained in efficient operating condition by periodic removal of accumulated grease, oil, scum, floating substance or other residue.

(g) *Construction.* Grease catch basins shall be constructed in the same general manner as provided for catch basins. The inlet and outlet shall be

placed as far apart as possible and the depth below outlet flow line shall be not less than 2 feet. The inlet shall not be submerged, and not be more than 12 inches above the flow line of the outlet invert. Grease catch basins shall be provided with a removable airtight concrete, steel or cast iron cover. When bolted covers are provided, the bolts shall be of a non-corrosive metal. See following sketch.

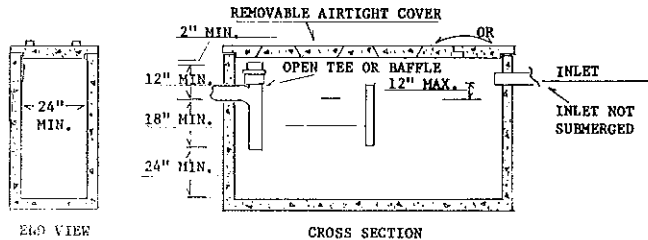

(9) **YARD CATCH BASINS.** (a) All building storm sewers used to drain paved areas, yards, courts, or similar areas may be connected directly with the storm sewer by means of a storm water inlet as specified in the following sketch.

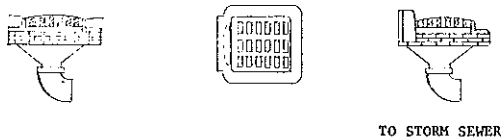

Where depth does not permit this type of storm inlet, a 36 inch vitrified clay or concrete manhole may be used. When such paved areas, yards, courts or similar areas are connected to an existing combined sewer, they shall first be intercepted in a yard catch basin. A yard catch basin shall be constructed in the same general manner as provided for catch basins; they shall be at least 36 inches in diameter and where possible the water level shall be at least 4 feet below finished grade. The outlet pipe or invert may be a tee installed in a vertical position with at least a 4 inch cleanout on top of the tee or a cast iron tee or wye in the horizontal plane. The outlet invert shall be submerged not less than 6 inches below the water line. The flow or water line shall not be less than 2 feet above the bottom. See following sketch.

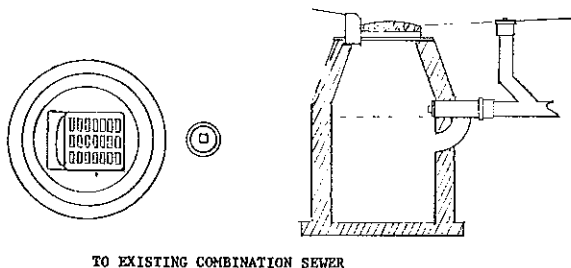

(b) The storm inlet or catch basin shall have an approved well fitted, removable, substantial cast iron or steel cover, strainer or grate of a thickness and strength to sustain the weight of anticipated traffic on it. The opening in such cover, strainer or grate shall be equal to or greater than the area of the sewer or waste outlet of the catch basin.

(c) A yard catch basin may be installed to receive surface drainage or discharge from a pump, hydrant, or other outside areas. It may connect

only with a storm sewer or existing combined sewer when approved by the local authority. See s. ILHR 82.12.

(10) **STABLE CATCH BASINS.** When liquid wastes from barns, stables, manure pits and yards are permitted to enter the public sewer system, they shall be intercepted by a catch basin. See following sketch.

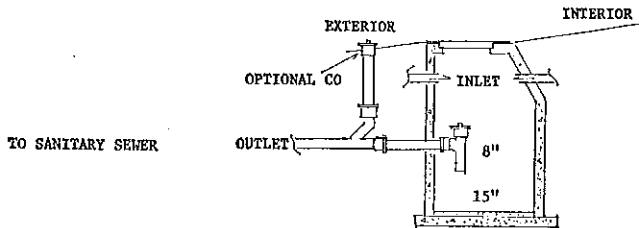

(11) **GARAGE CATCH BASINS.** Construction of garage catch basins or sand traps shall conform to general requirements for catch basins. The outlet invert should enter the walls of the basin so that the space between the water line in the basin and the floor level shall not exceed 10 inches. The outlet shall consist of a cast iron invert with a depth of invert of not less than 6 inches below the water line. The catch basin discharge pipe shall be provided with a full size cleanout. An open bar strainer not less than 24 inches in diameter shall be provided. Where it is impractical to keep the outlet within 10 inches of the floor level, a greater distance will be permitted. In such installations, a 4 inch local vent pipe shall be provided. Such local vent pipe shall enter the basin above the water line. Same shall terminate through roof or with a return bend outside of the building not less than one foot above the grade level. Where the nearly horizontal portion of the local vent pipe between the catch basin and the vertical portion of the local vent does not exceed 50 feet, properly intercepted floor drains, not to exceed 4, may be connected individually to the lowest horizontal portion of the local vent. Properly intercepted floor drains may connect to the catch basin. The maximum developed distance from the local vent pipe or the catch basin to the trap outlet shall not exceed 32 feet and the total pitch off the pipe shall not exceed the inside diameter. Floor drains installed under this section shall have an inside diameter of at least 3 inches. See following sketch.

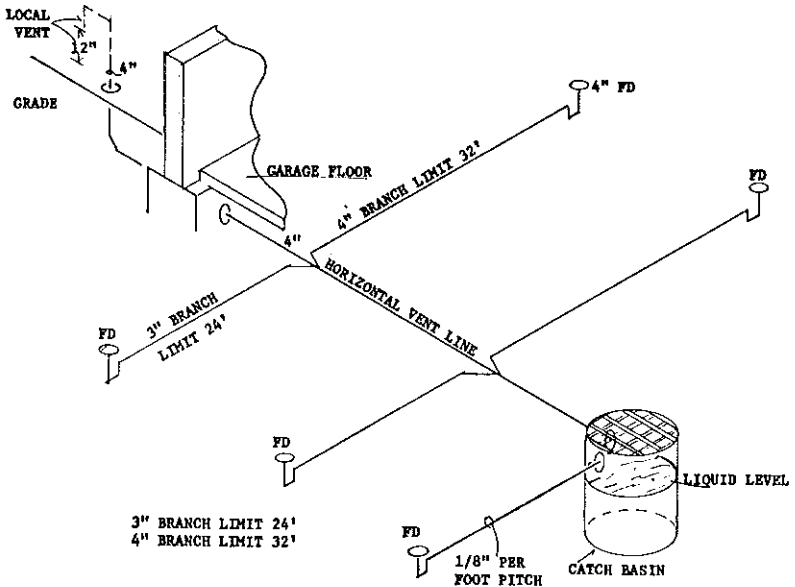

(12) **SUMPS.** (a) *Location.* All sanitary building subdrains shall discharge into an airtight and watertight sump or receiving tank, so located as to receive the drainage by gravity, from which sump or receiving tanks the drainage shall be lifted and discharged into the building drain or building sewer by pumps, ejector or any other method approved by the department. All sumps installed for the purpose of receiving clear water, basement or foundation drainage water shall be located at least 15 feet from any water well. All other sumps shall be located at least 25 feet from any water well. See s. ILHR 82.12 (1) (b).

(b) *Capacity.* The capacity of a sump or receiving tank receiving sanitary wastes shall be determined by computing all possible drainage tributary to the sump. Storage capacity of the sump or receiving tank shall not exceed a 12 hour period.

(c) *Air inlet.* Any sump receiving domestic wastes shall have a fresh air inlet. The size of the air inlet pipe required will depend upon the size of the sump, varying from 2 inches to 6 inches. The air inlet pipe may be connected to a plumbing system vent pipe or extended separately through the roof and conform with the provisions of this code.

(d) *Materials.* All sumps or receiving tanks shall be constructed in a watertight and substantial manner of concrete, precast reinforced concrete, cast iron, bitumastic enamel coated 12 gauge or heavier steel, vitrified clay or other material approved by the department.

(13) **EJECTORS.** (a) *Where required.* In all buildings in which the whole or a part of the plumbing and drainage system lies below the flow line of the main sewer, the sewage and domestic wastes shall be lifted by mechanical means and discharged into the main sewer, building drain or building sewer. Duplex pumping equipment shall be provided for other

than one family dwellings or where 6 or more water closets discharge to the sumps serving the installation.

(b) *Size.* The size and design of an ejector pump shall be determined by the capacity of the sump to be served, the discharge head and discharge frequency. Manufacturers' ratings may be used provided the minimum discharge capacity exceeds 20 gallons per minute. In one family dwellings the ejector or pump with a water closet or water closets connected shall be capable of passing a 2 inch diameter solid ball. All other ejectors or pumps with a water closet or water closets connected shall be capable of passing a 2½ inch diameter solid ball. The discharge piping of each ejector or pump with a water closet or water closets connected shall be a minimum inside diameter of 3 inches.

(c) *Vent.* The drain leading to a sump or receiving tank shall, when a closet or closets are installed, be provided with a vent stack not less than 3 inches in diameter. Where fixtures other than closets are installed, the vent pipe size shall be determined from the tables in s. ILHR 82.03 (1) and (3).

(d) *Discharge connections.* The discharge pipe from the ejector to the building drain shall be connected through a branch Y fitting. The drain into which the ejector discharges shall be of sufficient size to receive the combined flow from the building and the ejector. Flanged connections and long radius fittings shall be used. Full flow check valves shall be installed in each sewage ejector line. Horizontal check valves shall be used where possible.

(e) *Venting ejector connection.* Fixtures located on a building drain near the point where such building drain receives the discharge from an ejector shall be effectively protected against siphonage, and an additional air relief or vent pipe shall be provided where necessary. No fixtures shall be connected to the discharge pipe from an ejector, between the ejector and the point where it enters the bulding drain or sewer.

(f) *Maintenance.* All ejectors and like appliances shall receive care as needed to keep them in a satisfactory operating condition.

(14) **ACID WASTE PIPING.** Acid waste and vent pipe shall meet the following criteria:

(a) *Temperature resistance.* Temperature resistance shall be guaranteed by the manufacturer for use at operating temperatures from 0° to 200° F. Continuous exposure, with intermittent exposure up to 250° F., shall withstand repeated thermal variations of 130° F.

(b) *Flammability.* The materials shall be nonburning when tested according to A.S.T.M. D-635-68.

(c) *Pressure.* Pressure shall be guaranteed by the manufacturer for use from full vacuum to 15 psi.

(d) *Chemical resistance.* Chemical resistance shall be guaranteed by the manufacturer for use with the following chemicals at temperatures to 200° F., without reliance on dilution and flushing.

ILHR 82

Acids
 Acetic Acid 98% (glacial)
 Formic Acid 90%
 Hydrochloric Acid 20%
 Hydrochloric Acid 27%
 Nitric Acid 24%
 Nitric Acid 30%
 Nitric Acid 40%
 Nitric Acid 70% (conc.)
 Perchloric Acid
 Phosphoric Acid 85% (conc.)
 Sulfuric Acid 20%
 Sulfuric Acid 33%
 Sulfuric Acid 45%
 Sulfuric Acid 77%
 Sulfuric Acid 96% (conc.)

Bases
 Ammonium Hydroxide 28%
 Sodium Hydroxide 10%
 Sodium Hydroxide 20%
 Sodium Hydroxide 40%
 Sodium Hydroxide 50%
 Sodium Hydroxide Flake
 Sodium Sulfide

Organics
 Acetone
 Benzene
 Butyl Alcohol
 Carbon Tetrachloride
 Ethyl Acetate
 Ethyl Alcohol
 Formaldehyde
 Furfural
 Methanol
 Methyl Ethyl Ketone
 Naphtha
 Oil (Nujol)
 Phenol 85%
 Pyridine
 Toluene
 Xylene

Salts
 Potassium Dichromate
 Potassium Hydroxide 10%
 Potassium Permanganate (Sat.)
 Sodium Chloride
 Sodium Phosphate 5%
 Zinc Chloride

1. All chemical wastes shall be thoroughly diluted, neutralized, or treated by passing through an approved dilution or neutralizing basin of proper capacity before discharging into the sanitary sewer. The waste water discharge shall be monitored periodically for purposes of maintaining a pH of 7.0 plus or minus 1.0.

2. Vent piping on chemical waste systems shall be of the same material as the chemical waste pipe and shall be extended independently through the roof.

3. Sizing dilution or neutralizing basins shall be in accord with table 9. For quantities of fixtures exceeding 150 sinks, or for special type use or installation, the department shall be consulted.

Table 9

1 sink	5 gallon tank
4 sinks	15 gallon tank
8 sinks	30 gallon tank
16 sinks	55 gallon tank
25 sinks	100 gallon tank
40 sinks	150 gallon tank
60 - 75 sinks	250 gallon tank
100 sinks	350 gallon tank
150 sinks	500 gallon tank

4. When above capacities are to be served for neutralizing purposes without dilution process, the tank shall be filled to the level of the overflow (outlet) with marble or limestone chips of not less than 1 inch nor more than 3 inch diameter.

5. Vent pipe sizes serving dilution or neutralizing basins shall be in accord with table 10.

Table 10
 BASIN VENT PIPE SIZES

2 inch for 1-24 units (D.F.U.)
 3 inch for 25-126 units (D.F.U.)
 4 inch for 127 or more units (D.F.U.)

6. Basin vent terminals. Basin vent pipes may connect to the acid vent piping system or extend through the roof separately. A vent with a return bend may terminate outside the building at least 12 feet above grade, at least 8 feet from a door or openable window and at least 20 feet from a fresh air intake.

Note: Copies of standards promulgated by American Society for Testing Material are on file in the office of the revisor of statutes, secretary of state and dept. of industry, labor and human relations and may be obtained for personal use from American Society for Testing Material, 1916 Race Street Philadelphia, PA 19103.

History: 1-2-56; r. and recr. Register, November, 1972. No. 203, eff. 12-1-72; renum. from H 62.11, Register, July, 1983, No. 331, eff. 8-1-83.

ILHR 82.12 Storm and clear water. (1) **DISPOSAL.** (a) *Storm sewer system.* Inside roof leaders, clear water wastes, groundwater drains, foundation footing, refrigerator cooling water, storm water drains, drinking fountains, air-conditioning, paved areas, parking lots, courts and other clear water wastes not described shall discharge to a storm sewer system where available.

(b) *Other disposal.* Where no storm sewer system is available or exists or is not adequate to receive the anticipated flow, the storm and clear water wastes shall be discharged in accord with local governmental requirements.

(c) *Prohibited discharge.* Storm and clear water wastes shall not discharge to a sewer carrying sanitary wastes.

(d) *Controlled roof drainage.* See s. ILHR 82.05 (4).

(2) **STORM SEWERS.** (a) *Materials and installation.* Materials and installation of storm sewers shall be as specified for sanitary sewers except corrugated steel pipe may be used. See limitations, s. ILHR 82.19.

(b) *Size.* The building storm sewer shall be sized as required in s. ILHR 82.04 (3) (b).

(3) **STORM BUILDING DRAINS.** (a) *Materials and installation.* Materials and installation of storm drains shall be as specified for sanitary building drains.

(b) *Size.* The building storm drain shall be sized as required in s. ILHR 82.05 (3) (b).

Table 11
SIZE OF HORIZONTAL STORM DRAINS ACCORDING
TO ROOF AREA SERVED

Pipe Size	Pitch 1/16" per 1' sq. ft. area	Pitch 1/8" per 1' sq. ft. area	Pitch 1/4" per 1' sq. ft. area	Pitch 1/2" per 1' sq. ft. area
3"	650	910	1,300	1,820
4"	1,300	1,950	2,990	3,770
5"	2,470	3,640	5,070	7,020
6"	4,160	5,980	8,320	11,700
8"	9,320	13,000	18,200	26,000
10"	17,680	24,700	33,800	50,440
12"	27,300	41,080	57,200	81,900
15"	52,000	72,800	105,800	146,640
18"	85,800	121,550	174,200	247,000
21"	156,520	179,660	256,880	374,400
24"	187,200	261,560	382,200	546,000

Table 11a

MINIMUM SIZE OF HORIZONTAL STORM DRAINS SERVING PAVED
OR GRAVELED GROUND SURFACE AREAS

Pipe Size	Pitch 1/16" per 1' sq. ft. area	Pitch 1/8" per 1' sq. ft. area	Pitch 1/4" per 1' sq. ft. area	Pitch 1/2" per 1' sq. ft. area
3"	810	1,140	1,625	2,270
4"	1,625	2,430	3,740	4,720
5"	3,090	4,550	6,350	8,760
6"	5,200	7,470	10,400	14,600
8"	11,650	16,250	22,750	32,600
10"	22,100	30,850	44,250	63,000
12"	34,150	52,300	71,500	102,200
15"	65,000	91,000	131,500	183,000
18"	107,000	152,000	210,800	321,000
21"	195,000	224,000	321,000	468,000
24"	234,000	336,000	478,000	682,000

Table 11b

MINIMUM SIZE OF HORIZONTAL STORM DRAINS SERVING
LAWNS, PARKS AND SIMILAR LAND SURFACES

Pipe Size	Pitch 1/16" per 1' sq. ft. area	Pitch 1/8" per 1' sq. ft. area	Pitch 1/4" per 1' sq. ft. area	Pitch 1/2" per 1' sq. ft. area
3"	2,600	3,640	5,200	7,280
4"	5,200	7,800	11,960	15,080
5"	9,880	13,560	20,280	28,080
6"	16,640	23,920	33,280	46,800
8"	37,280	52,000	72,800	112,000
10"	69,720	98,800	135,200	201,760
12"	109,200	164,320	228,800	327,600
15"	208,000	291,200	421,200	586,560
18"	343,200	490,200	596,800	988,000
21"	326,080	718,640	1,027,520	1,497,600
24"	748,800	1,046,240	1,528,800	2,184,000

(c) *Other clear water wastes.* Where there is a continuous or semi-continuous discharge into the building storm drain, such as refrigerator cooling water, compressor cooling water, drinking fountains, ornamental ponds and other clear water drains not described herein, each gallon per minute of discharge shall be computed as 26 square feet of roof area. Table 12 may be used for sizing clear water drains other than storm water drains.

Table 12

APPROXIMATE CAPACITY OF HORIZONTAL DRAINS

Pipe Size	Pitch 1/16" per 1' GPM	Pitch 1/8" per 1' GPM	Pitch 1/4" per 1' GPM	Pitch 1/2" per 1' GPM
3"	25	35	50	70
4"	50	75	115	145
5"	95	140	195	270
6"	160	230	320	450
8"	355	500	700	1,000
10"	680	950	1,300	1,940
12"	1,050	1,580	2,200	3,150
15"	2,000	2,800	4,050	5,640
18"	3,300	4,675	6,700	9,500
21"	6,020	6,910	9,880	14,400
24"	7,200	10,060	14,700	21,000

(d) *Backflow valves.* Building storm drains subject to backflow or backwater at the time of installation shall be provided with adequate back-

water valves, installed to prevent interference with the flow and be readily accessible.

(4) **AREA DRAINS.** (a) *Window well drains.* All window well areas not exceeding 50 square feet shall be properly drained. This area drain may discharge to a subsoil or foundation drain through a minimum 2 inch diameter pipe or to the building storm drain. The drain inlet should be provided with a strainer.

(b) *Area drains.* An area drain shall be provided for open subsurface spaces 50 square feet or more in area. The drain shall discharge to the building storm drain, storm subdrain or storm sewer. If no storm sewer exists, the discharge shall be as specified in s. sub. (1) (b). The area drain shall have a minimum inside diameter of 2 inches and shall not discharge into a subsoil, footing or foundation drain.

(5) **RAINWATER CONNECTIONS.** (a) All roof conductors placed within a building, interior court, ventilating pipe or shaft shall be installed as specified for soil, waste and vent pipes except black iron or steel pipe may be used. Black iron or steel roof conductors shall not be embedded in masonry or concrete.

(b) When rainwater conductors installed outside a building discharge to a storm sewer or drain, the horizontal portion extending 2 feet inside the exterior wall and the vertical portion outside the wall shall terminate with the hub above grade and shall be made of cast iron pipe.

(c) *Roof drains.* Roof drains shall be made of cast iron, copper, lead or other material approved by the department.

1. Storm water inlets for use on sun decks, parking decks, surface areas and similar areas may be of the flat surface type and shall have an available inlet area of not less than 2 times the required area of the conductor.

2. Roof drains, other than those specified in subd. 1., shall be equipped with strainers extending not less than 4 inches above the surface of the roof immediately adjacent to the roof drain. Strainers shall have an available inlet area, above the roof, of not less than 1½ times the area of the conductor to which the drains connect.

(6) **TRAPS FOR STORM AND CLEAR WATER WASTES.** (a) Traps shall not be required for storm water conductors when the conductors extend to the roof of a building unless the drain inlet is within 8 feet of a door or openable window or within 20 feet of a fresh air inlet.

(b) Area drains will not require a trap unless such drain inlet is within 8 feet of a door, openable window or 20 feet from a fresh air intake. One or more drain inlets may be connected to a single trap which shall be located immediately inside the building.

(c) Footing, foundation and subsoil drains shall discharge into a trap or trapped drain tile receiver and be provided with a cleanout. A trap is not required with footing, foundation and subsoil drains discharge to a sump and pump which elevate the waste.

(d) Traps are required at all interior drain inlets receiving clear water wastes.

(e) Inlets of drains receiving clear water wastes shall terminate wherever possible at least 2 inches above the floor but in no case less than 1 inch.

(7) **VENTS REQUIRED.** (a) A trap receiving clear water wastes shall be supplied with a properly installed vent. Such vent or vents shall not connect to the sanitary plumbing system.

(b) Vents shall not be required for traps which receive storm water wastes exclusively.

(8) **CLEANOUTS.** (a) *Size.* Cleanouts shall conform to s. ILHR 82.10 (5) and (7).

(b) *Storm drain.* A cleanout with a brass screw cover or other type approved by the department shall be provided at a point where the drain leaves the building. This cleanout shall be extended from the building drain with cast iron soil pipe to the surface of the finished floor or grade and wherever practical shall be not less than 2 inches above the finished floor or grade. An additional cleanout located 28 to 30 inches above the floor shall be provided in all roof conductors. Cleanouts will not be required in roof conductors in a one story building provided the roof conductor does not exceed 25 feet in length and does not have an offset greater than 45° from the vertical.

(c) *Storm drain branches.* Cleanouts shall be provided in all storm drain branches exceeding 25 feet in length.

(d) *Storm sewer access.* Building storm sewer cleanouts shall be installed as required in s. ILHR 82.04 (4) (h).

(9) **PROHIBITED CONNECTIONS.** Rainwater conductors shall not be used as soil, waste or vent pipes; nor shall any soil, waste or vent pipes or clear water waste piping be used as rainwater conductors.

History: Cr. Register, November, 1972, No. 203, eff. 12-1-72; renum. from H 62.12, Register, July, 1983, No. 331, eff. 8-1-83.

ILHR 82.13 Water distribution systems. (1) **GENERAL REQUIREMENTS.** Every building equipped with plumbing fixtures and used for human occupancy or habitation shall be provided with a potable supply of cold water. No water service shall pass under or through a building to serve another building. In residences and buildings serving the public and places of employment, hot water shall be provided.

(2) **WATER SERVICE.** (a) *Size.* The minimum inside diameter of a water service pipe shall be ¾-inch. The minimum size water service pipe may be increased by the local government or the utility by published ordinance or rule approved by the department. The size of the water service shall be determined by the requirements of sub. (4) (b) or (c). When sub. (4) (c) is used, the minimum pressures specified in sub. (4) (c) 1. g., shall be included in the calculations.

(b) *Materials.* The water service including pipe and fittings to any building shall be type K copper with copper or brass fittings, brass, cast iron, ductile iron, galvanized open hearth iron, galvanized steel, plastic, asbestos cement or other materials approved by the department. Any of the above materials used within bounds of, or beneath an area subject to easement for highway or street purposes or public service right-of-ways

shall be subject to acceptance by the local government or the utility by published ordinance or rule approved by the department. See ss. ILHR 82.19 and 82.24 for material standards.

(c) *Valve controls.* Water service controls shall include a corporation cock or valve at the main, a curb stop at or near the property line and inside the wall of each building and on the water distribution side of the water meter.

Note: The water service terminates at the meter valve or within 3 feet where the pipe penetrates the building floor or wall.

1. The corporation cock or valve at the main shall be a ground key stop-cock. An approved gate valve may be used for services 3 inches or larger.

2. The curb stop shall be an approved gate valve, ground key stop-cock or a ball valve which shall be installed between the curb and the property line. When a private water supply serves more than one building a curb stop is required for each building. For a water service 3 inches or larger, one valve may serve as the shut off at the main and for the curb stop. See following sketch.

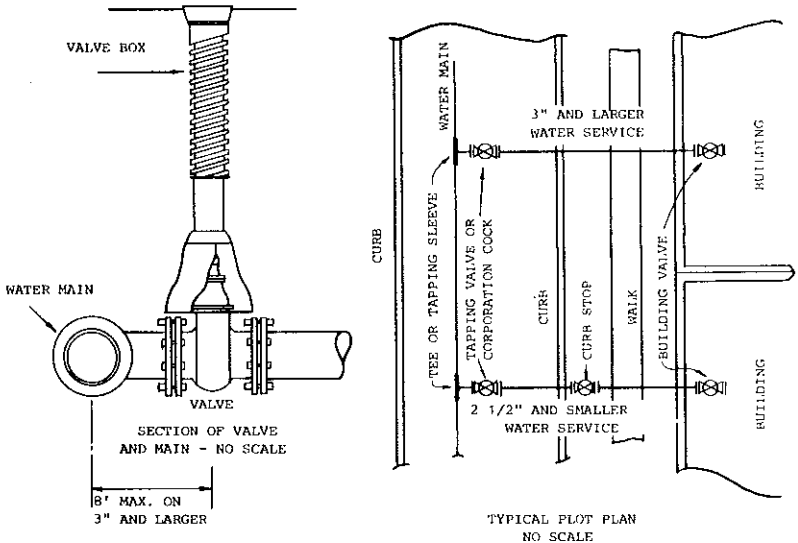

3. *Building and meter valves.* An approved valve shall be provided at the meter or at a point not more than 3 feet inside where the service penetrates the building floor or wall and another on the water distribution side of the meter. A valved bypass shall be provided for all 1½ inch or larger water meters. The bypass may be a minimum of one nominal pipe size smaller than the water service. When parallel meters are installed, a bypass may not be required provided the other meter(s) adequately serve the building water distribution requirements.

4. *Prohibited valves.* Combination stop and waste valves shall not be installed underground in water service piping. Frostproof yard hydrants shall be approved by the department.

(d) *Separation of water service and building sewers.* 1. Except as permitted below, the underground water service pipe and building sewer shall not be less than 8 feet apart horizontally and shall be separated by undisturbed or compacted earth. The water service pipe may be placed in the same trench with the building sewer under the following conditions:

- a. The water service and the building sewer are installed concurrently.
- b. The bottom of the water service pipe at all points shall be at least 12 inches above the top of the sewer line.
- c. The water service pipe shall be placed on the solid shelf excavated at one side of the common trench or the water service be installed at the side of the common trench with the 12 inches of bedding material meeting the following criteria. The initial backfill on the sides of the sewer pipe and to the 12-inch depth above the sewer shall be well tamped prior to installing the water service pipe. The bedding material shall be of medium to coarse sand, pea gravel or rock screenings.
- d. The number of joints in the water service pipe shall be kept to a minimum.
- e. The water service shall be located a minimum of 10 feet from a septic tank or soil absorption site.
- f. The materials and joints of water service pipe shall be installed in such a manner and shall possess the necessary strength and durability to prevent the escape of liquids and gases therefrom under adverse conditions such as corrosion, strain due to temperature changes, settlement, vibrations and superimposed loads.

2. Where the building sewer is existing, the water service pipe shall be installed in a separated trench pursuant to subd. 1., excepting a replaced water service may be installed pursuant to subd. 1. b. and c.

(3) **FIXTURE SUPPLY.** (a) *Potable water.* Only potable water shall be used in the processing of food, medical or pharmaceutical products, serving plumbing fixtures, appliances and appurtenances.

(b) *Identification.* Where 2 or more distribution systems are installed, each system shall be identified either by color marking, metal tags or other methods as may be approved by the department. All valves shall be tagged potable or nonpotable water.

1. **Color marking.** When color marking is used, potable water lines should be painted green and nonpotable water lines should be painted yellow. This requirement may be met by painting 3-inch wide bands at intervals of not more than 25 feet and at points where piping passes through walls, floors or roofs, in which case the bands shall be applied to the piping on both sides of the walls and both above and below the floor or roof. Points of outlets for nonpotable water shall be marked with a tag or color coded.

2. **Metal tags.** When tags are used, potable waterlines and valves shall be identified by 3-inch diameter metal tags bearing the legend SAFE WATER in letters not less than 1/2-inch in height. Nonpotable water lines and valves shall be identified by firmly attached metal tags having the shape of a 4-inch equilateral triangle bearing the legend WATER UNSAFE in letters not less than 7/16-inch in height. As in the use of color

bands, tags shall be attached to pipes at intervals of not more than 25 feet and at either side of points where pipes pass through walls and above and below points where pipes pass through floors or roofs.

(4) **WATER SERVICE AND DISTRIBUTION DESIGN.** (a) *Design.* Water distribution piping systems shall be designed and installed so the maximum velocity through the piping shall not exceed 8 feet per second. Sizing of the water service and distribution system may be calculated and designed in accord with par. (b) or (c), whichever is applicable. Where street main pressures fluctuate, the water service, water meter and building distribution shall be designed for the minimum pressure available.

(b) *Sizing the water service and water distribution system by tables.* 1. **Limitations.** Where the total developed length of the water service is 75 feet or less and the total developed length of the water service and water distribution piping is 250 feet or less and the quantity of the water supply demand in total water supply fixture units, as determined from table 13 does not exceed the fixture units listed in tables 13a, 13b or 13c, the minimum size of the water service shall be determined from table 13a, 13b or 13c.

2. The following information is required. a. Pressures and elevations.

1) Maximum and minimum pressure at the water main or other supply source. The minimum pressure at the main is used for design purposes. The maximum design pressure of the water distribution system is 80 p.s.i.g.

2) The difference in elevation between the street main or other source and the highest fixture or outlet and the pressure loss through any equipment such as a water conditioner, water meter, water heater, water filter, pressure regulator, pressure reducing valves, reduced pressure backflow preventer or similar devices.

b. Length. The total developed length of the piping from the water main or other source of supply to the furthestmost fixture.

c. Supply demand. The number of total water supply fixture units (s.f.u.) for all fixtures and other water uses as specified in table 13.

Note: See subd. 2. d., for sizing the water service and distribution when flush valves are installed.

d. Supply demand; Flush valves. Branches, mains and risers serving water closet or similar flush valves may be sized from table 13a, 13b or 13c, when the following values are assigned to each flushometer valve by beginning with the most remote valve on each branch.

First	flushometer	valve	40	fixture	units
Second	“	“	30	“	“
Third	“	“	20	“	“
Fourth	“	“	15	“	“
Fifth	“	“	10	“	“

Five fixture unit value flushometer valves may be computed at half the above values. After the fifth flushometer valve on any main, branch or riser, fixture loadings may be computed using the values given in table 13. No piping supplying a flushometer valve shall be less than the valve inlet.

3. Sizing the water service. a. Table selection. After determining the minimum water pressure at the source as specified in 2. a. 1), subtract $\frac{1}{2}$ pound per square inch of pressure for each 1 foot of difference in elevation between the source and the highest fixture and any pressure loss through equipment as specified subd. 2. a. 2). Select table 13a, 13b or 13c with the pressure ranges that contain the calculated pressure.

b. Length column selection. Select the length column that is equal to or greater than the total developed length.

c. Size column selection. Follow down the column to a fixture unit value (s.f.u.) equal to or greater than the total number of fixture units required for the installation. The size of the water service will be found in the column labeled water service.

4. Sizing the water distribution system. Starting at the most remote fixture on the cold water supply and the hot water supply, apply the cold water or hot water fixture supply demand units as applicable from table 13 to the cold water or hot water supply adding the fixture units as additional fixtures are connected. Using table 13a, 13b or 13c, as selected in subd. 3. a., and the length column selected in subd. 3. b., select a horizontal line that meets or exceeds the fixture unit demand of that section of piping. Except for the minimum requirements in par. (c) 1. e., f. and table 15, the size of the water distribution main, water distribution branch, fixture supply branches and risers will be found in the column labeled building distribution. The water distribution main serving water heaters and the cold water demand shall be sized to deliver the above required hot water demand, plus all required cold water demands but in no case need the piping be larger than that required for the total building supply as computed in subd. 4.

Table 13
WATER SUPPLY FIXTURE DEMAND UNITS

Fixture	Occupancy	Type Control	Weight in Fixture Units		
			Hot	Cold	Total
Water Closet	Public	FL. Valve		10.	10.
Water Closet	Public	FL. Tank		5.	5.
Urinal	Public	½" FL. Valve		5.	5.
Urinal	Public	¾" FL. Valve		5.	5.
Lavatory	Public	Faucet	1.5	1.5	2.
Bathtub or Shower Head	Public	Faucet	3.	3.	4.
Service Sink	Offices, etc.	Faucet	2.25	2.25	3.
Kitchen Sink	Hotels-Restaurants	Faucet	3.	3.	4.
Drinking Fountain	Offices, etc.	⅜ Valve		0.25	0.25
Water Closet	Private	FL. Valve		6.	6.
Water Closet	Private	FL. Tank		3.	3.
Lavatory	Private	Faucet	0.75	0.75	1.
Lavatory-Treatment or Clinical	Public	Faucet	1.	1.	1.5
Bathtub or Shower Head	Private	Mixing Valve	1.5	1.5	2.
Kitchen Sink	Private	Faucet	1.5	1.5	2.
Laundry Trays (1 to 3 compartments)	Private	Faucet	2.25	2.25	3.
Combination Fixture	Private	Faucet	2.25	2.25	3.
Dishwashing Machine	Private	Automatic	1.		1.
Emergency Eyewash	Public	Faucet		1.	1.
Laundry Machine (8 lb)	Private	Automatic	1.5	1.5	2.
Laundry Machine (8 lb)	Public or General	Automatic	2.25	2.25	3.
Laundry Machine (Large)	Refer to Manufacturer's Requirements				
Bathroom Group	Private	FL. Valve	2.25	8.25	9.
Bathroom Group	Private	FL. Tank	2.25	5.25	6.
Bidet	Public	Variable	3.00	3.00	4.
Coffee Urn Stand	Public	Variable		2.	2.
Food Waste Grinder	Public	Variable		2.	2.
			Manufacturer's Require.		
Hose-Pre-Rinse	Public	Variable	2.5	2.5	3.
Hose Station	Public	Variable	3.0	3.0	4.
Ice Maker	Public	Variable		1.	1.
Sink - Baker's Pan	Public	Variable	2.5	2.5	3.
Sink - Back Bar	Public	Variable	1.5	1.5	2.
Sink - Barber and Shampoo	Public	Faucet	1.5	1.5	2.
Sink - Cook's	Public	Variable	2.5	2.5	3.
Sink - Cup	Public	Variable		1.	1.
Sink - Diet Kitchen	Public	Variable	1.5	1.5	2.
Sink - Laboratory	Public	Variable	1.5	1.5	2.
Sink - Laboratory and Trough	Public	Variable	1.5	2.5	3.
Sink - Meat Preparation	Public	Variable	2.5	2.5	3.
Sink - Pot and Pan (Per Faucet)	Public	Variable	3.	3.	4.
Sink - Salad Preparation	Public	Variable	2.5	2.5	3.
Sink - Silver Soak	Public	Variable	2.5	2.5	3.
Sink - Treatment or Exam	Public	Variable	1.5	1.5	2.
Sink - Vegetable	Public	Variable	2.5	2.5	3.
Ice Cuber & Flakers	Public	Variable		1.	1.
Hosebibb - Wall Hydrant	Public and Private	Variable		4.	4.
Wall Hydrant C.W. & H.W.	Public and Private	Variable	3.	3.	4.
Wash Fountain - Factory	Public	Variable	1.5	1.5	2.
Wash-up (20" = 1 Lav Space)					

"Private" fixtures are those in residential areas not freely accessible, such as in private homes, residential apartments, hotel guest rooms, private rooms or apartments in residential hotels, dormitories or executive suites and the like.

Table 13a

**MAXIMUM FIXTURE UNITS (s.f.u.) WATER SERVICE AND DISTRIBUTION
SIZING CALCULATED PRESSURE RANGE 30 THROUGH 45 PSI**

Water Service Not to Exceed 75 Feet	Building Distribution	Maximum Total Developed Allowable Length In Feet				
		75	100	150	200	250
3/4"	3/4"	20	18	15	12	9
3/4"	1"	20	18	16	16	15
1"	1"	30	27	24	21	20
1"	1-1/4"	39	36	32	30	28
1-1/4"	1"	32	32	32	28	23
1-1/4"	1-1/4"	56	49	44	35	32
1-1/4"	1-1/2"	56	56	56	51	48
1-1/2"	1-1/4"	56	56	56	56	56
1-1/2"	1-1/2"	109	103	84	63	56
1-1/2"	2"	127	123	111	103	86
2"	1-1/2"	111	111	111	78	66
2"	2"	275	264	186	175	146

Table 13b

**MAXIMUM FIXTURE UNITS (s.f.u.) WATER SERVICE AND DISTRIBUTION
SIZING CALCULATED PRESSURE RANGE 46 THROUGH 60 PSI**

Water Service Not to Exceed 75 Feet	Building Distribution	Maximum Total Developed Allowable Length In Feet				
		75	100	150	200	250
3/4"	3/4"	20	18	18	18	16
3/4"	1"	30	28	26	24	22
1"	1"	34	34	34	34	30
1"	1-1/4"	58	56	54	49	46
1-1/4"	1"	34	34	34	34	34
1-1/4"	1-1/4"	58	58	58	58	54
1-1/4"	1-1/2"	111	95	86	78	69
1-1/2"	1-1/4"	58	58	58	58	58
1-1/2"	1-1/2"	111	111	111	111	99
1-1/2"	2"	225	220	196	175	170
2"	1-1/2"	111	111	111	111	111
2"	2"	275	275	275	275	250

Table 13c

MAXIMUM FIXTURE UNITS (s.f.u.) WATER SERVICE AND DISTRIBUTION
SIZING CALCULATED PRESSURE RANGE OVER 60 PSI
(but not to exceed 80 PSI)

Water Service Not to Exceed 75 Feet	Building Distribution	Maximum Total Developed Allowable Length In Feet				
		75	100	150	200	250
3/4"	3/4"	20	18	18	18	18
3/4"	1"	34	32	30	28	26
1"	1"	34	34	34	34	34
1"	1-1/4"	58	58	58	58	54
1-1/4"	1"	34	34	34	34	34
1-1/4"	1-1/4"	58	58	58	58	58
1-1/4"	1-1/2"	111	111	111	111	98
1-1/2"	1-1/4"	58	58	58	58	58
1-1/2"	1-1/2"	111	111	111	111	111
1-1/2"	2"	275	275	250	235	215
2"	1-1/2"	111	111	111	111	111
2"	2"	275	275	275	275	275

(c) Friction loss method for sizing the water service and distribution system. 1. The supply demand in gallons per minute in the building water distribution system shall be determined on the basis of the load in terms of supply fixture units and of the relationship between load and supply demand as shown in tables 13 and 14. Water supply outlets for items not listed in table 13 shall be computed at their maximum demand but in no case less than:

FIXTURE	NUMBER OF FIXTURE UNITS	
	PRIVATE USE	PUBLIC USE
3/8-inch pipe	1	2
1/2-inch pipe	2	4
3/4-inch pipe	3	6
1 inch pipe	6	10

a. For supply outlets likely to impose continuous demands, estimate continuous supply separately in gallons per minute and add to total demand in gallons per minute for fixtures.

b. The given weights in table 13 are for total demand and for fixtures with both hot and cold water supplies. The weights for maximum separate demands are taken as 1/4 the listed total demand for the hot water supply and the cold water supply.

c. Compute flush valve demand separately.

d. Demand (GPM) Corresponding to Fixture Load (WSFU). To determine the demand in gallons per minute corresponding to any given load in water supply fixture units, reference must be made to table 14, Table for Estimating Demand.

Table 14

ESTIMATING DEMAND

Supply Systems Predominantly For Flush Tanks		Supply Systems Predominantly For Flush Valves	
Load (Water Supply Fixture Units)	Demand GPM	Load (Water Supply Fixture Units)	Demand GPM
6	5		
8	6.5		
10	8	10	27
12	9.2	12	28.6
14	10.4	14	30.2
16	11.6	16	31.8
18	12.8	18	33.4
20	14	20	35
25	17	25	38
30	20	30	41
35	22.5	35	43.8
40	24.8	40	46.5
45	27	45	49
50	29	50	51.5
60	32	60	55
70	35	70	58.5
80	38	80	62
90	41	90	64.8
100	43.5	100	67.5
120	48	120	72.5
140	52.5	140	77.5
160	57	160	82.5
180	61	180	87
200	65	200	91.5
225	70	225	97
250	75	250	101
275	80	275	105.5
300	85	300	110
400	105	400	126
500	125	500	142
750	170	750	178
1,000	208	1,000	208
1,250	240	1,250	240
1,500	267	1,500	267
1,750	294	1,750	294
2,000	321	2,000	321
2,250	348	2,250	348
2,500	375	2,500	375
2,750	402	2,750	402
3,000	432	3,000	432
4,000	525	4,000	525
5,000	593	5,000	593
6,000	643	6,000	643
7,000	685	7,000	685
8,000	718	8,000	718
9,000	745	9,000	745
10,000	769	10,000	769

e. Size. The diameter of any pipe serving more than one plumbing fixture or appliance shall not be less than $\frac{3}{4}$ -inch inside diameter.

f. Minimum size. The minimum size of a water distribution branch serving no more than one fixture shall be as shown in table 15. The water distribution branch shall be extended to within at least 18 inches of the point of connection to the fixture.

Table 15

MINIMUM SIZES OF WATER DISTRIBUTION BRANCHES

Type of Fixture or device	I.D. Pipe Size (Inches)	Type of Fixture or device	I.D. Pipe Size (Inches)
Bathtubs	1/2	Shower (single head)	1/2
Combination sink and tray	1/2	Sinks (service, mop)	1/2
Drinking fountain	3/8 (1' max)	Sinks (flushing rim)	3/4
Dishwasher (domestic)	1/2	Urinal (direct flush valve)	3/4
Electric drinking water cooler	3/8 (1' max)	Urinal (direct flush valve)	1/2 (1' max)
Kitchen sink, residential	1/2	Water closet (tank type)	3/8 (1' max)
Kitchen sink, commercial	3/4	Water closet (flush valve type)	1 (1' max)
Lavatory	3/8 (1' max)	Hose bibb	1/2
Laundry tray 1, 2 or 3 compartments	1/2	Wall hydrant	1/2

g. Minimum hydrostatic pressure. Based on the minimum hydrostatic pressure available, pipe sizes shall be selected so that under conditions of peak demand a minimum flow pressure at the point of discharge shall be not less than required to maintain minimum flow rates listed in table 16. Pipe sizes for flush valve water closets and urinals shall be adequate to maintain flow pressures of 20 pounds per square inch for blowout action and jet action fixtures. For fixtures other than those supplied by flush valves, a minimum pressure of 8 pounds per square inch at the highest fixture shall be included in the calculations.

Table 16

MINIMUM AND MAXIMUM FLOW RATES TO FIXTURES AND APPURTENANCES

Fixture	Flow Rate Minimum GPM	Flow Rate Maximum GPM
Lavatory - Residential		3
Lavatory - Public		1 after handle release
Sink	4	4
Bathtub	6	
Laundry tray	5	
Shower except for safety - each head		3
Water closets		
Tank type		4 gal. per flush
Blowout action		4 gal. per flush
Jet action		4 gal. per flush
Drinking fountain	0.75	
Wall hydrant	5	
Urinal		1.5 gal. per flush

h. Variable street pressures. Where street water main pressures fluctuate, the building water distribution system shall be designed for the minimum pressure available.

i. Location and size of water supply source. Location and size of the public water main, where available, should be obtained from the local water authority.

j. Elevations. The relative elevations of the source of water supply and the highest water supply outlets in the building must be determined. In the case of a public main, the elevation of the point where the water service connection is to be made to the public main must be obtained from the local water authority.

k. Maximum total developed length of system. Information shall be obtained regarding the total developed length of the water service piping from the source of water supply to the water service control valve of the building. Determine the total developed length of the distribution piping from the service control valve to the highest and most remote water outlet on the system.

l. Friction loss. Calculate the permissible uniform pressure loss for friction in the system. The amount of pressure available for dissipation as friction loss due to pipe, fittings, valves and appurtenances or devices in the system, must be divided by the maximum total developed length of the water service and water distribution system. This establishes the pipe friction limit for the circuit or system in terms of pressure loss, in psi, per foot of total pipe length. Multiply this value by 100 in order to express the pipe friction unit in terms of psi per 100 feet of length. If specifications for pressure loss due to fittings and valves are not furnished, add 50% of the maximum total developed length for friction loss.

m. Size all parts of the basic design circuit or system, and all other main lines in accordance with tables 16a, 16b, 16c, 16d or 16e. The table selected shall correspond with the type of material approved for the water service, water distribution or both.

Table 16a

PRESSURE LOSS DUE TO FRICTION—
COPPER WATER TUBE, TYPE K (ASTM B88)
Surface Condition: "Fairly Smooth"
 $q = 4.57 p^{0.546} d^{2.64}$

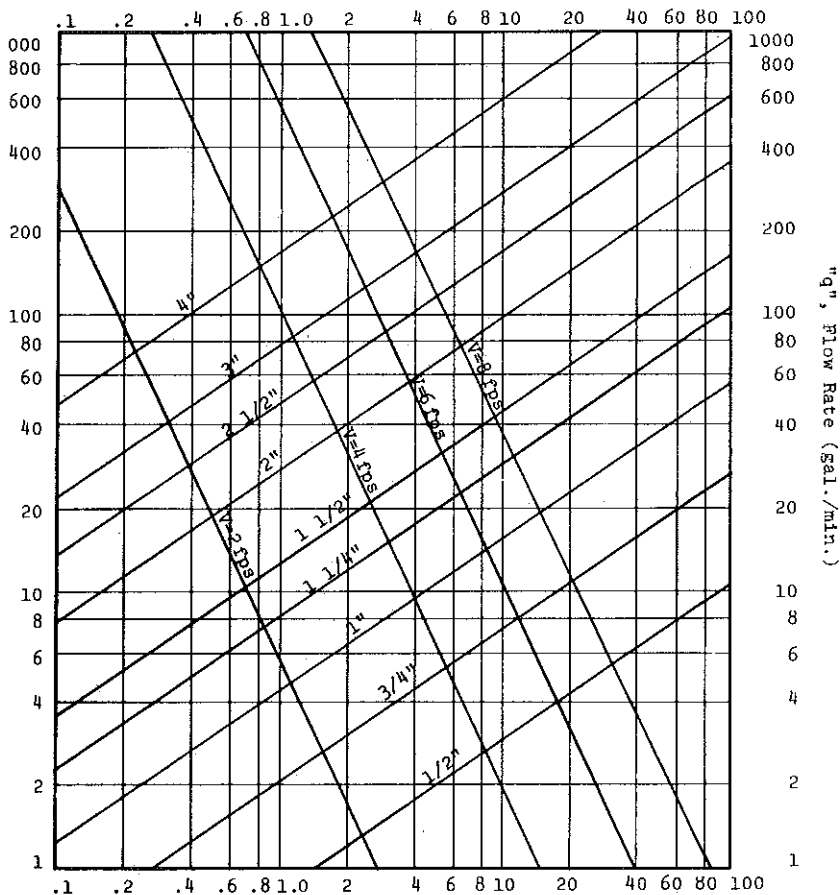

"p", Pressure Loss Due To Friction (psi/100 ft. of pipe)

Table 16b

PRESSURE LOSS DUE TO FRICTION—
COPPER WATER TUBE, TYPE L (ASTM B88)

Surface Condition: "Fairly Smooth"

$$q = 4.57 p^{0.526} d^{2.64}$$

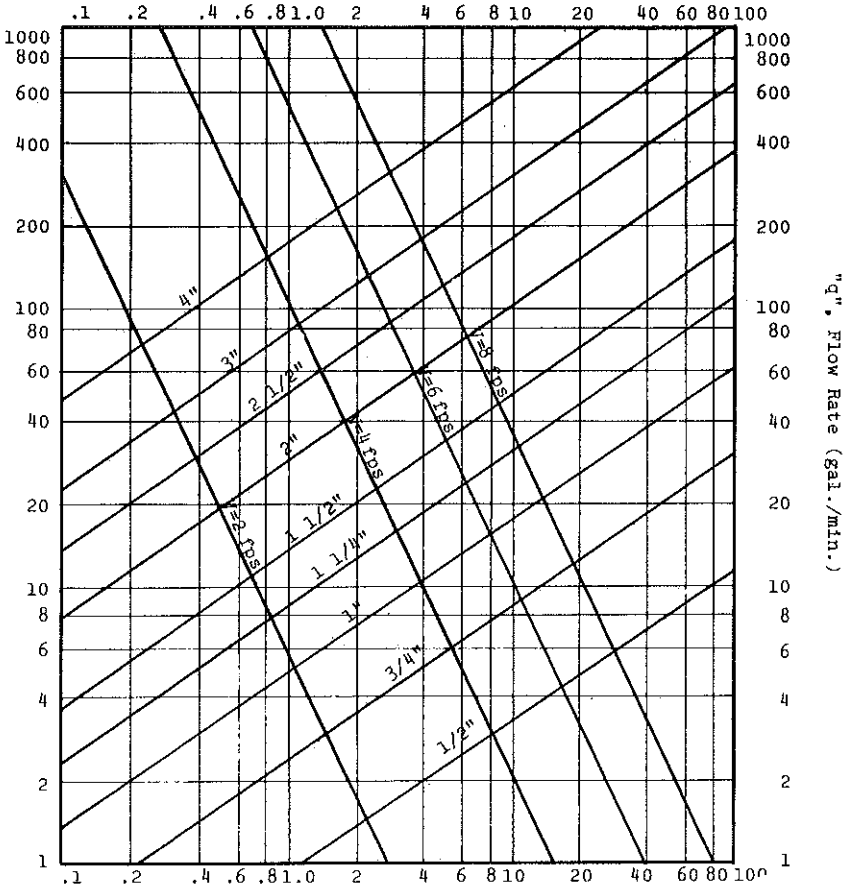

"p", Pressure Loss Due To Friction (psi/100 ft. of pipe)

Table 16c

PRESSURE LOSS DUE TO FRICTION—
 COPPER WATER TUBE, TYPE M (ASTM B88)
 Surface Condition: "Fairly Smooth"
 $q = 4.57 p^{0.546} d^{2.64}$

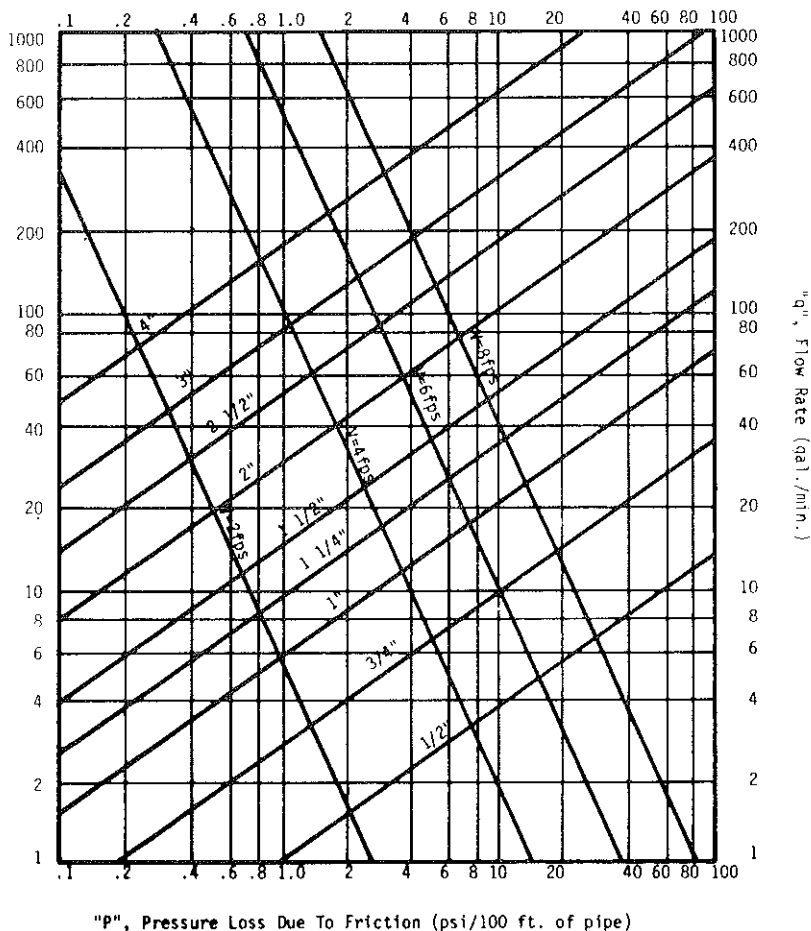

"p", Pressure Loss Due To Friction (psi/100 ft. of pipe)

Table 16d

PRESSURE LOSS DUE TO FRICTION—
GALV. IRON & STEEL STANDARD WEIGHT PIPE
(ASTM A72, A120)

Surface Condition: "Fairly Rough"

$$q = 4.29 p^{0.521} d^{2.562}$$

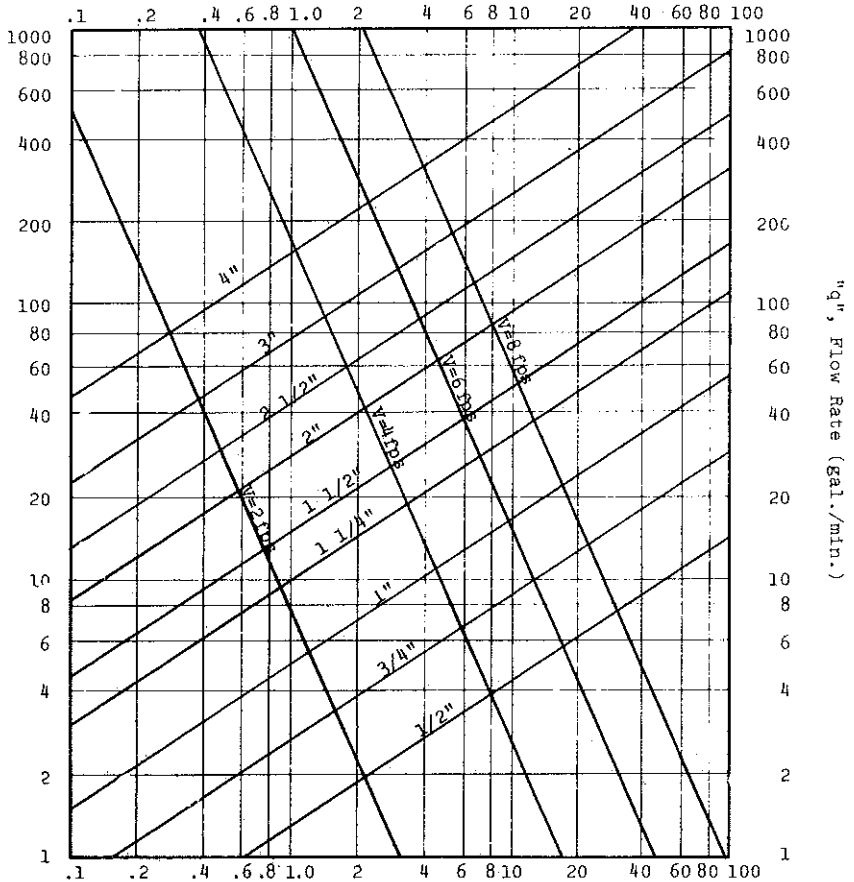

"p", Pressure Loss Due To Friction (psi/100 ft. of pipe)

Table 16e
FLOW DATA FOR THERMOPLASTIC PIPE
SCHEDULE 40

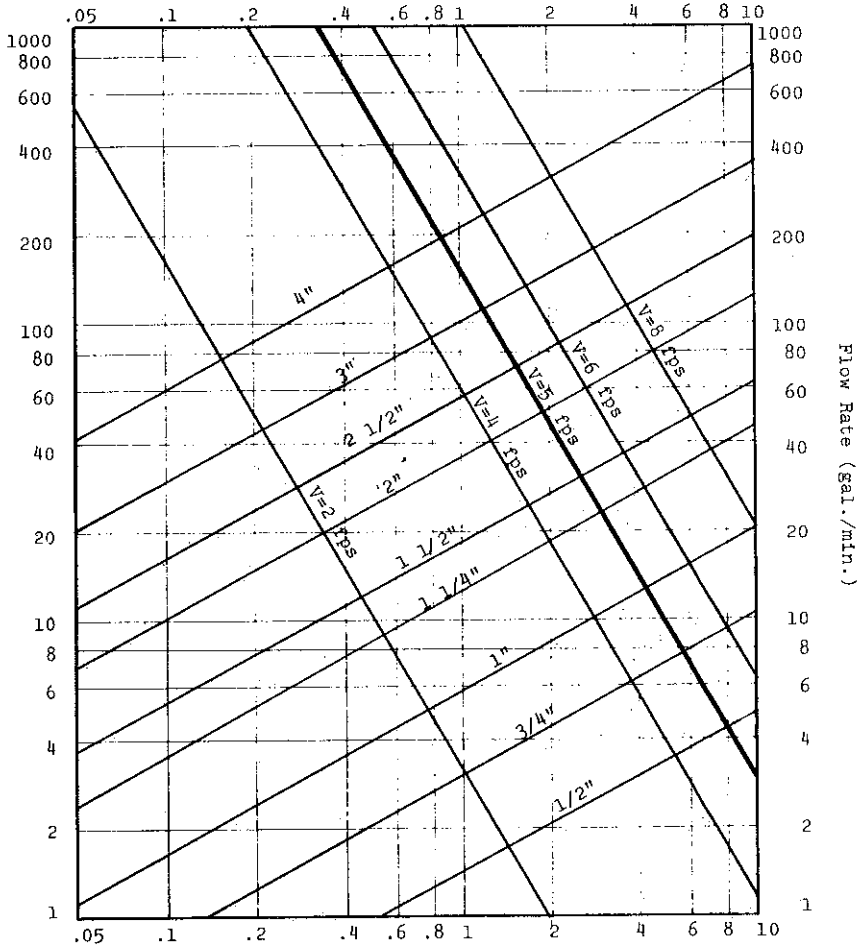

“p”, Pressure Loss Due To Friction (psi/100 ft. of pipe)

n. Hot water distribution. In residences, buildings serving the public and places of employment, hot water shall be supplied to all plumbing fixtures and equipment used for personal hygiene, bathing, washing, culinary purposes, cleansing, laundry or building maintenance.

2. Excessive pressures. Water pressure at any fixture, appliance or appurtenance shall not exceed 80 psi for a period not to exceed 60 minutes in any 24-hour period under no flow conditions. When the water pressure in a part of or the entire water distribution system serving a fixture(s), appliance(s), or appurtenance(s) exceeds 80 psi for a period of more than 60 consecutive minutes, an approved type pressure reducing valve, preceded by a strainer, shall be installed and the pressure reduced to 80 psi or less for that part or all of the system that serves a fixture(s), appliance(s) or an appurtenance(s). Outside wall hydrants, sill cocks, water supply directly to a water pressure booster system, elevated water gravity tank or to pumps provided in connection with a hydropneumatic or elevated gravity water supply system may be left at full pressure.

3. Design methods. The methods utilized in designing and sizing the water distribution system may vary and recognized engineering practices meeting the criteria established in s. ILHR 82.01 (4) and sub. (4) will be acceptable to the department. When submitting plans and specifications to the department for plan examination include all calculations and data relating to the sizing of the water distribution system.

(d) *Materials and installation.* 1. Materials. All water distribution pipes (within a building) shall be of galvanized steel, brass, or cast iron (piping) with brass or galvanized malleable iron fittings; type K, L or M copper water tube with copper or brass fittings or other materials approved by the department.

2. Frost protection. All water pipe, storage tanks, fixtures, appliances and appurtenances subject to low temperatures shall be, so far as practical, effectively protected against freezing.

3. Bending of pipe. Bending of water distribution piping except fixture supply tubing is prohibited. (See s. ILHR 82.19 (2) (a) 7.)

(e) *Supports.* All piping shall be supported to prevent undue strains upon connections or fixtures and shall be so aligned and graded that the entire system or parts thereof can be controlled and drained. The formation of traps or sags in water piping shall be avoided where possible. When unavoidable such sags, traps or inverts shall have provisions for properly draining same.

(f) *Water temperature control — public buildings.* Temperature of mixed water to multiple or gang showers shall be controlled by a master thermostatic blender or such showers may be individually regulated by pressure balance mixing valves. Individual showers in commercial and public buildings shall have pressure balance mixing valves in addition to flow regulation as indicated in table 16.

1. Return circulation where required. Hot water supply risers in buildings 5 or more stories in height or in buildings where developed length of hot water piping from the source of the hot water supply to the farthest fixture exceeds 100 feet, shall be of the return circulation type and no uncirculated branch line shall exceed 25 feet in length. Valves shall be

provided on the inlet and outlet of all circulating return lines and on the inlet and outlet of the return circulation pump.

2. Insulation - storage tanks. Heat loss from unfired hot water storage tanks shall be limited to 15 BTU per hour per square foot of external tank surface area. The design ambient temperature shall be no higher than 65°F.

3. Insulation - piping. Piping heat loss for recirculation systems shall be limited to a maximum of 25 BTU per hour per square foot of external pipe surface for aboveground piping and a maximum of 35 BTU per hour per square foot of external pipe surface for underground piping. Maximum heat loss shall be determined at a ΔT equal to the maximum water temperature minus a design ambient temperature no higher than 65°F.

(g) *Water heaters and hot water storage tanks.* 1. General. All water heaters either for domestic or industrial use shall be of an approved type and shall connect to the water distribution system in an approved manner. All heaters except electric heaters shall be provided with a flue of rust resistant material connected to a chimney or gas vent stack. All water heaters shall be permanently marked with the rated input of the heater in B.T.U. or watts. Such marking shall be in an accessible position on the outside of the heater for inspection purposes.

2. Safety devices. All safety devices, except mixing valves, shall meet the current requirements of one or more of the following: American Gas Association, Underwriters Laboratories, Inc., American Society of Mechanical Engineers or National Board of Boiler and Pressure Vessel Inspectors. Test and certification by a laboratory in accordance with one of the above applicable standards shall also be considered acceptable. All water safety devices shall be of the temperature and pressure type installed in accordance with this code.

Note: The above standards are on file in the offices of the department of industry, labor and human relations, secretary of state, and revisor of statutes, and may also be obtained for personal use as follows:

1) Approval requirements for gas water heaters, volume I, Seventeenth Edition, 1965.

Approval requirements for gas water heaters, volume II, effective January 1, 1963.

Approval requirements for gas water heaters, volume III, third edition, 1965. Listing requirements for relief valves and automatic gas shutoff devices for hot water supply systems, effective January 1, 1965 and addenda effective January 1, 1966.

The above standards are available from American Gas Association, Inc., 605 Third Avenue, New York, New York 10016.

2) Standards for safety, household electric storage-tank water heaters, UL 174, third edition, May 1, 1970, and revision pages dated June 16, 1971, January 18, 1971.

The above standards are available from:

Underwriters' Laboratories, Inc.
207 E. Ohio Street, Chicago, IL 60611
333 Pfingsten Road, Northbrook, IL 60062
1655 Scott Boulevard, Santa Clara, CA 95050
1285 Walt Whitman Road, Melville, L.I., NY 11746

3) ASME Boiler and Pressure Vessel Codes, Heating Boilers, section IV, 1971, available from American Society of Mechanical Engineers, 29 West 39th Street, New York, NY 10018.

4) Relieving capacities of safety valves and relief valves, January 1, 1970.

The above standards are available from The National Board of Boiler and Pressure Vessel Inspectors, 1155 North High Street, Columbus, OH 43201.

3. Tank construction. Storage tanks for direct fired storage type water heaters shall be constructed to withstand a minimum of 300 psi test pressure without leakage or permanent distortion and shall bear the manufacturers' marking showing test and working pressure, except that in lieu thereof, pressure markings appearing on AGA or UL listed water heater units will be considered acceptable.

4. Hot water storage tank and heater drain valves. a. Location. A drain valve shall be installed at the lowest point of each hot water storage tank and be readily accessible.

b. The drain valve shall be hand-operable without the use of tools.

c. The drain valve inlet shall be a minimum $\frac{3}{4}$ -inch nominal iron pipe size and the outlet end shall be equipped with a minimum standard $\frac{3}{4}$ -inch hose thread.

5. Water heaters, storage tanks and boilers. a. Combination domestic water heating/space heating boilers. Space heating boilers shall not be used for service water heating from May 1 to September 30 unless the service water heating load equals or exceeds 30% of the net boiler load.

b. Temperature controls. Service water heating systems shall be equipped with automatic temperature controls capable of adjusting from the lowest to the highest acceptable temperature setting for the intended use.

c. Shut down. A separate means shall be provided to permit turning off the energy supplied to service water heating systems.

(h) *Relief valves.* 1. Pressure relief valves. Pressure relief valves shall meet the A.S.M.E. standards. The valves shall have a relief rating adequate to meet the pressure conditions in the equipment served. The relief valve shall be installed either directly in a top tank tapping or in the hot water outlet line close to the tank. In a tankless-type heater, the relief valve shall be installed in the hot water outlet line as close as possible to the unit. There shall be no shut-off valve between the pressure relief valve and the tank. The pressure relief valve must be set to open at not less than 25 p.s.i. above the street main pressure or not less than 25 p.s.i. above the setting of any building water pressure regulating valve. The setting shall not exceed the tank rated working pressure.

2. Temperature relief valves. Temperature relief valves shall be of adequate relief rating expressed in B.T.U./hr for the equipment served. They shall be installed so that the temperature sensing element is immersed within the top 6 inches of the tank. The valve shall be set to open when the stored water temperature is 210°F. (or less).

3. Combination pressure temperature relief valves. Combination pressure temperature relief valves shall comply with all the requirements of the separate pressure and temperature relief valves.

4. Energy cut-off devices. Energy cut-off devices shall be of adequate performance rating for the equipment served. Immersion type energy cut-off devices shall be located so that the temperature sensing element is immersed in the water within the tank and controls the temperature of

the water within the top 6 inches of the tank. When approved by the department, contact types shall be installed so that the sensing element is responsive to the highest water temperature within the equipment served and is securely fastened in place. When an energy cut-off device is used, it shall be factory applied by the heater manufacturer and comply fully with the appropriate standards of A.N.S.I. or U.L. They shall be installed in a manner that will isolate them from ambient flue gas temperatures and other conditions not indicative of the temperature of the water within the heater.

5. Installation of relief valve discharge. Every relief valve shall have a discharge pipe the same size as the outlet drain on the relief valve which shall terminate not more than 10 inches above the floor as close as possible to a drain properly connected to the building drain or sewer. Such discharge pipe shall be galvanized steel, copper or brass, installed with approved fittings. The relief valve discharge pipe shall be pointed and drained downward in such a manner to allow the drain and discharge pipe to drain dry. The base or end of such discharge pipe shall not be threaded. No discharge pipe shall terminate into an open fixture such as a sink, laundry tub, bathtub, bathtub overflow, urinal, fixture tailpiece or supply tank, etc., or installed in a freezing area. No check valve or shut-off valve shall be installed between any safety device and the hot water equipment used, nor shall there be any valve in the discharge pipe from the relief valve.

6. Vacuum relief valves. Where a hot water storage tank or direct or indirect water heater is located at an elevation of 20 feet from the bottom of the heater or more above the lowest fixture outlets in the hot water system, a vacuum relief valve shall be installed on the storage tank or heater.

7. Pressure marking of hot water storage tanks. Hot water storage tanks shall be permanently marked in an accessible place with the maximum allowable working pressure.

(i) *Water hammer suppressors.* 1. Water hammer suppressors. All water supply systems, water distribution systems and components connected thereto, subject to water hammer, shall be provided with approved shock absorbing devices located and sized to suppress water hammer. All appliances, devices, equipment, fixtures and appurtenances with quick closing valves or which may create water hammer, shall be provided with shock absorbing devices. When copper air chambers are used, the minimum size shall be $\frac{1}{2}$ " x 1" x 14".

2. Mechanical suppressors. The size and location of the suppressors shall be in accord with the hydraulic design of the piping system served and to the manufacturer's recommendations. All mechanical water hammer suppressors shall be accessible.

Note: The water hammer suppressor may be eliminated provided the appliance, appurtenance, device, equipment or fixture has a slow closing or manually closed valve and does not create water hammer.

(j) *Water distribution control valves.* 1. Single family dwellings. Controls within a single family dwelling unit shall include a valve for each lawn sprinkler faucet, water heater, water closet, point of entrance of the water service, discharge side of the water meter and each appliance or appurtenance.

2. Multiple dwellings and public buildings. a. In all public buildings and multiple dwelling units, each hot and cold water distribution main, riser and branch main shall be valved. All fixtures, appliances, appurtenances, lawn sprinkler faucets and wall hydrants shall be valved. The meter valve on the discharge side of the meter may serve as the water distribution main valve. See following sketch.

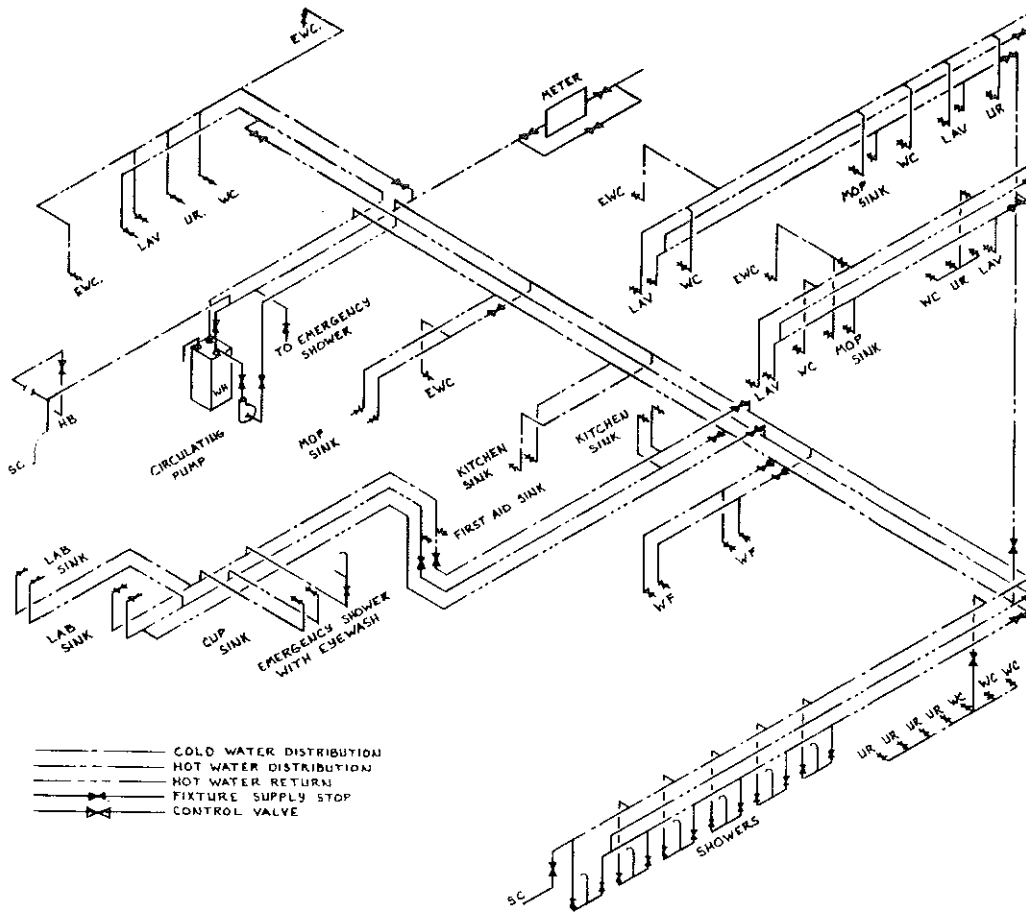

b. Riser valves. A valve shall be installed at the foot of each water supply riser or in the branch main serving a single riser. In buildings incorporating down feed risers a valve shall be installed at the top of each water supply down feed riser. See following sketch.

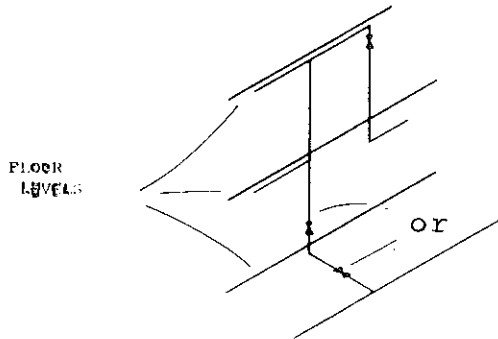

c. Water heating equipment valve. The cold water branch to each hot water storage tank or water heater shall be provided with a valve located in the same room near the equipment and serving only this equipment. Each tank or heater shall be equipped with an approved safety relief valve as specified in pars. (g) and (h).

d. Water conditioner bypass. All commercial water conditioners shall be provided with a valved bypass. The bypass may be a minimum of one nominal pipe size smaller than the water supply to the unit.

e. Valves location. All water supply control valves shall be placed so as to be accessible for service and maintenance.

f. Control valve design. Fixture supply valves shall have flow capacity, without reducing the pressure at the fixture to less than the minimum specified in this section, to provide the minimum flows as required in table 16. Line valves $\frac{3}{4}$ -inch inside diameter and larger shall be the same size as the pipe being served and have a Cv factor not less than that specified in the following table for the particular pipe size.

I.D. Pipe Size	Minimum Cv Factor
$\frac{3}{4}$	18
1	35.5
1- $\frac{1}{4}$	61
1- $\frac{1}{2}$	107
2	175
3	255
4	340

Note: The Cv factor is defined as the flow coefficient for valves, expressing the flow rate in gallons per minute of 60" with a 1 psi pressure drop across the valve.

g. Tank controls. Supply lines from pressure or gravity tanks shall be valved in the same room at or near the tanks.

h. Hospital and nursing home valving requirements. See s. ILHR 82.15 (82.16) (10) (b).

(5) WATER PRESSURE BOOSTER SYSTEMS. (a) *Where required.* When the water pressure in the public water main or individual water supply system is insufficient to supply the probable peak demand flow to all plumbing fixtures and other water needs freely and continuously within the minimum pressures and quantities specified in sub. (4) (c), tables 13, 14, 15 and 16; or elsewhere in this section and in accordance with good practice, the rate of supply shall be supplemented by an elevated water tank, a hydropneumatic pressure booster system, or a water pressure booster pump.

(b) *Overflows for water supply tanks.* Each gravity or unpressurized water supply tank shall be provided with an overflow having a diameter not less than shown in table 17. The overflow outlet shall discharge above and within 6 inches of a roof drain or site drain which terminates in a storm sewer. The overflow outlet shall be covered by a corrosion resistant screen of not less than 16 x 20 mesh to the inch and by ¼ inch hardware cloth or shall terminate in a horizontal angle seat check valve. Drainage from overflow pipes shall be directed so as not to freeze on roof walkways.

Table 17

SIZES FOR OVERFLOW PIPES FOR WATER SUPPLY TANKS

Maximum Capacity of Water Supply Line of Tank	Diameter of Overflow Pipe (Inches ID)	Maximum Capacity of Water Supply Line to Tank	Diameter of Overflow Pipe (Inches ID)
0- 13 gpm -----	1½	356- 640 gpm -----	5
14- 55 gpm -----	2	641-1040 -----	6
56-100 gpm -----	2½	over-1040 gpm -----	8
101-165 gpm -----	3	-----	—
166-355 gpm -----	4	-----	—

(c) *Covers.* All gravity and unpressurized water supply tanks shall have a locked overlapping cover. The covers of these tanks shall be vented with a return bend vent pipe having an area not less than the area of the down feed riser pipe and the vent shall be screened with corrosion resistant screening having not less than 14 and not more than 20 openings per linear inch.

(d) *Potable water inlet control and location.* Potable water inlets to gravity and unpressurized tanks shall be controlled by an automatic supply valve so installed as to prevent the tank from overflowing. The inlet shall be terminated so as to provide an approved air-gap, but in no case less than 6 inches above the overflow.

(e) *Tank drain pipes.* Each tank shall be provided at its lowest point with a valved pipe to permit emptying the tank which shall discharge as required for overflow pipes and not smaller in size than shown in table 18.

Table 18

SIZE OF DRAIN PIPES FOR NONPRESSURIZED WATER TANKS

Tank Capacity (gallons)	Drain Pipe (inches)	Tank Capacity (gallons)	Drain Pipe (inches)
Up to 750	1	3001 to 5000	2½
751 to 1500	1½	5001 to 7500	3
1501 to 3000	2	over 7500	4

(f) *Low pressure cut-off required on booster pumps.* When a booster pump is used on a water pressure booster system, there shall be installed a low pressure cut-off on the booster pump to prevent a pressure of less than 20 p.s.i.g. on the inlet side of the pump.

(g) *Pressure tanks, vacuum relief.* All elevated water pressure tanks 20 feet to the bottom of the tank or more above the lowest fixture shall be provided with a vacuum relief valve at the top of the tank which will operate up to a maximum water pressure of 200 p.s.i. and to maximum water temperatures of 200°F. The minimum size of such vacuum relief valves shall be ½ inch.

(6) **DISINFECTION OF POTABLE WATER SYSTEM.** (a) *Procedure.* New or repaired potable water systems should be disinfected prior to use. The method to be followed shall be as follows.

1. The pipe system shall be flushed with clean, potable water until no dirty water appears at the points of outlet.

2. The system or part thereof shall be filled with a solution of water and chlorine containing at least 50 parts per million of chlorine and the system or part thereof shall be valved off and allowed to stand for 24 hours or the system or part thereof shall be filled with a solution of water and chlorine containing at least 200 parts per million of chlorine and allowed to stand for 3 hours.

3. Following the allowed standing time, the system shall be flushed with clean potable water until no chlorine remains in the water coming from the system.

4. The procedures shall be repeated if it is shown by a bacteriological examination that contamination still exists in the system.

(7) **SPECIAL EQUIPMENT.** (a) *Separate piping for each source.* A water supply that meets accepted standards for purity for human consumption shall be distributed through a piping system entirely independent of any piping system conveying another water supply.

(b) *Piping by plumber.* Only persons licensed by the department as a master, journeyman plumber or a registered plumber apprentice, under supervision, shall install water supply piping to any system designed for steam power, heating, temperature regulation, automatic fire protection, air-conditioning, comfort cooling, process piping, hydraulic power or for any special water usage for industrial or manufacturing purposes. All such piping for supplying water for any of the above listed uses shall be brought by the licensed plumber to a point within the building or structure and within 10 feet of the point of entry to any of the above systems

where it shall terminate with an air-gap or other method approved by the department.

(c) *Piping by equipment installers.* Connection of systems specified in par. (b) to the water supply pipe and the discharge therefrom through an air-gap into a trap, fixture, receptacle or interceptor installed by the licensed plumber, as prescribed by rules and regulations, may be made by the person installing such systems.

History: 1-2-56; r. and recr. Register, November, 1972, No. 203, eff. 12-1-72; r. and recr. Register, February, 1979, No. 278, eff. 3-1-79; renum. from H 62.13, Register, July, 1983, No. 331, eff. 8-1-83.

ILHR 82.14 Back-siphonage, cross-connections and potability control. (1) PROTECTION OF POTABLE WATER SUPPLY. (a) *General.* Potable water supply systems shall be designed, installed and maintained in such manner as to prevent contamination from non-potable liquids, solids or gases from being introduced into the potable water supply through cross-connections or any other piping connections to the system.

(b) *Interconnections.* Interconnections of water services between 2 or more public water systems, water distribution systems, or a private and public supply shall be permitted only with approval of the department.

(c) *Cross-connection control.* Cross-connections are prohibited except as approved by the department when suitable protective devices such as the reduced pressure zone backflow preventer or equal are installed, tested and maintained to insure proper operation on a continuing basis.

(d) *Water treatment.* All water treatment compounds approved by the department for introduction into the potable water distribution system shall be by a positive displacement pump.

(e) *Painting of water tanks.* The interior surface of the potable water tank shall not be lined, coated, painted or repaired with any material which will affect either the taste, odor, color or potability of the water supply when the tank is placed in or returned to service.

(f) *Used piping.* Piping which has been used for any other purpose than conveying potable water shall not be used for conveying potable water.

(g) *Water supply to boilers.* Potable water supply to boilers or boiler feed water systems shall be through an air-gap or approved backflow preventer.

(h) *Prohibited connections to fixtures and equipment.* Connection to the potable water supply system for the following shall be protected against backflow or back-siphonage.

1. Operating, dissection, embalming and mortuary tables or similar equipment. In such installations the hose used for water supply shall terminate at least 12 inches away from every point of the table or attachments. See following sketch.

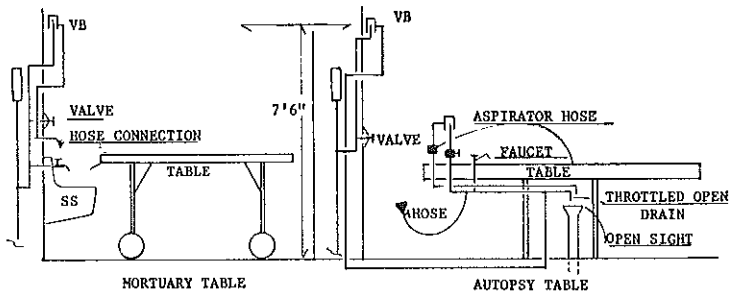

2. No closet bowl or other fixture equipped with a flushometer valve or with flushing tanks shall be installed with a side or rear spud located below the lower part of the flush rim of the bowl.

3. Seat acting water closets.

4. Bedpan washers.

5. Bidets.

6. Sterilizers with water supply connections.

7. Therapeutic baths with inlets below the rim of the fixture.

8. Water operated waste ejectors.

9. Bathtubs with inlets below the rim of the fixture.

10. Wash basins with inlets below the rim of the fixture.

11. Bar, soda fountain or other sinks with submerged inlets.

12. Laundry trays with faucets below the rim.

13. Sinks with faucets or water inlets below the rim and sinks with loose hose connections.

14. Dishwashing sinks or machines with water inlets below the rim.

15. Cuspidors with water supply connections.

16. Dental cuspidors with water supply connections.

17. Hospital appliances. See s. ILHR 82.15 [82.16].

18. Frostproof hydrants with underground bleed or an automatic live-stock water device.

19. Industrial vats, tanks, etc., of a description which have an inverted water supply connection or a water supply connection below the top of the spill rim or in which a hose filler is used.

20. Industrial water supplied process appliance with direct water connections.

21. A rubber hose with hand control or self-closing faucets attached as used in connection with baths, industrial vats, canneries, etc.

22. Pressure water supplied sealing rings on sewage and sludge pumps.

23. Water supply for priming connections.

24. Water supply (hot or cold) to laundry equipment.

25. Condenser cooling connections for refrigeration and air-conditioning machinery.

26. Drains from fire sprinklers connected direct to sewer or waste.

27. Steam tables.

28. Condensers.

29. Stills.

30. Aspirators.

31. Chlorinators.

32. Photographic developing tanks.

33. Fixture inlets or valve outlets with hose attachments which may constitute a cross-connection shall be protected by an approved vacuum breaker installed at least 6 inches above the highest point of usage and located on the discharge side of the last valve. Manufactured fixtures with integral vacuum breakers shall be approved by the department.

34. Laboratory water faucets and cocks with serrated nipples or hose connections.

35. Lawn sprinkling faucets.

36. Any other fixture or installation creating a backflow or back-siphonage hazard.

(i) *Used water return prohibited.* Water used for cooling of equipment, space heating or other processes shall not be returned to the potable water system. Such water shall be discharged into a drainage system through an air-gap or may be used for non-potable purposes on written approval of the department.

(j) *Water outlets.* A potable water system shall be protected against the backflow and back-siphonage by providing at each water outlet:

1. An air-gap as specified herein between the potable water outlet and the flood level rim of the fixture it supplies or between the water outlet and any other source of contamination or,

2. Where an air-gap is impractical, a backflow preventer device or vacuum breaker approved by the department.

(k) *Minimum required air-gap.* Minimum required air-gap shall be measured vertically from the lowest end of a potable water outlet to the flood rim or line of the fixture or receptacle into which it is discharged.

The minimum required air-gap shall be twice the effective opening of a potable water outlet unless the outlet is a distance less than 3 times the effective opening away from a wall or similar vertical surface in which case the minimum required air-gap shall be 3 times the effective opening of the outlet. In no case shall the minimum required air-gap be less than shown in table 19.

Table 19
MINIMUM AIR-GAPS FOR PLUMBING FIXTURES

FITURE	MINIMUM AIR-GAP	
	When Not Affected By Near Wall (Inches)	When Affected By Near Wall (Inches)
Lavatories and other fixtures with effective opening not greater than 1/2 inch diameter	1	1½
Sink, laundry trays, goose-neck bath faucets and other fixtures with effective openings not greater than 3/4 inch diameter -----	1½	2¼
Over rim bath fillers and other fixtures with effective openings not greater than 1 inch diameter -----	2	3
Drinking water fountains—single orifice not greater than 7/16 (0.437) inch diameter or multiple orifices having total area of 0.150 square inches (area of circle 7/16 inch diameter) -----	1	1½
Effective openings greater than one inch -----	2 x diameter of effective opening	3 x diameter of effective opening

(l) *Devices for the protection of potable water supply.* Approved backflow preventers or vacuum breakers shall be installed with any plumbing fixture or equipment, the potable water supply outlet of which may be submerged and which cannot be protected by a minimum air-gap.

(m) *Approval of devices.* Before any device for the prevention of backflow or back-siphonage is installed, it shall be approved by the department. In its determination, the department may use the results of a recognized testing laboratory. Devices installed in the building potable water supply distribution system for protection against backflow or back-siphonage shall be maintained in good working condition by the person or persons responsible for the maintenance of the system.

(n) *Protective devices required.* In the installation of the following list of fixtures and devices where an air-gap is not provided or is impractical, approved protective devices shall be installed in all supply lines according to table 20.

Table 20

CROSS-CONNECTIONS WHERE PROTECTIVE DEVICES ARE REQUIRED AND CRITICAL LEVEL (C-L) SETTINGS FOR BACKFLOW PREVENTERS¹

Fixture or Equipment	Method of Installation
Aspirators and ejectors -----	C-L at least 6 inches above flood level of receptacle
Cup beverage vending machines ---	C-L at least 12 inches above flood level of machine
Dental units -----	On models without built-in vacuum breakers C-L at least 6 inches above flood level rim of bowl
Dishwashing machines -----	C-L at least 6 inches above flood level of machine
Flushometers (closet and urinal) ---	C-L at least 6 inches above top of fixture supplied
Garbage can cleaning machines ---	C-L at least 6 inches above flood level of machine
Hose outlets -----	C-L at least 6 inches above highest point on hose line
Laundry machines -----	C-L at least 6 inches above flood level of machine
Turf irrigation systems -----	C-L at least 12 inches above highest sprinkler or discharge outlet
Steam tables -----	C-L at least 6 inches above flood level
Tanks and vats -----	C-L at least 6 inches above flood level rim or line
Flush tanks -----	Equip with an approved ballcock. In all cases the ballcock should be located above the overflow level of the tank and the outlet terminated one inch above the overflow or provided with a backflow preventer located at least one inch above the overflow
Hose bibbs (where aspirators or ejectors could be connected) -----	C-L at least 6 inches above flood level of receptacle served

¹ Critical Level (C-L) is defined as the level to which the backflow preventer (vacuum breaker) may be submerged before backflow will occur. Where C-L marking is not shown on the preventer, the bottom of the device shall be taken as the C-L.

(o) *Connections subject to back pressure.* Where a potable water connection is made to a pipe line, fixture, tank, vat, pump or other equipment with a hazard of backflow or back-siphonage and where the water connection is subject to back pressure and an air-gap cannot be installed, the department shall require the use of an approved reduced pressure zone backflow preventer. A partial list of such connections is shown in Table 21.

Table 21

PARTIAL LIST OF CROSS-CONNECTIONS SUBJECT TO BACK PRESSURE

Chemical lines	Pumps
Cup beverage vending machines	Steam lines
Dock water outlets	Swimming pools
Individual water supplies	Tanks and vats—bottom inlets
Industrial process water lines	Hose bibbs
Pressure tanks	

(p) *Installation of devices.* 1. Vacuum breakers. Vacuum breakers shall be installed with the critical level at least 6 inches above the flood level rim of the fixture they serve and on the discharge side of the last control

valve to the fixture. No shut-off valve or faucet shall be installed beyond the vacuum breaker.

2. Reduced pressure zone backflow preventer. A reduced pressure zone type backflow preventer may be installed subject to full static pressure.

3. Devices of all types. Backflow and back-siphonage preventing devices shall be accessibly located, preferably in the same room with the fixture they serve. Installation in utility or service spaces, provided they are readily accessible is also permitted.

4. Barometric loop. Water connections not subject to back pressure where an actual or potential backflow or back-siphonage hazard exists may in lieu of devices specified, be provided with a barometric loop. See following sketch.

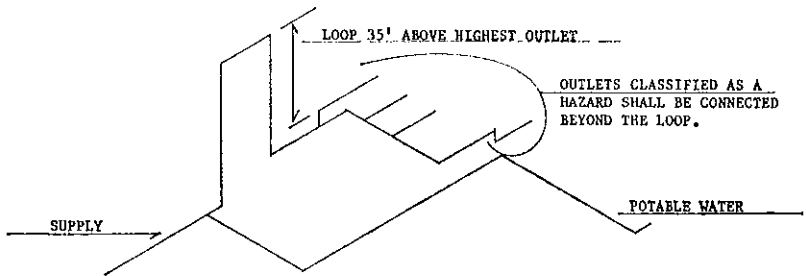

(q) *Turf sprinklers.* Turf sprinkler systems, when connected to a potable water system, shall be installed in accordance with these regulations. Adequate and proper provisions shall be made for control and drainage and to prevent back-siphonage or backflow. Water shall not be turned on to any turf sprinkler system until it has been inspected and approved. Materials used in turf sprinkler systems shall be submitted for evaluation and approval prior to installation.

(2) **IMPROPER LOCATION OF SEWERS AND DRAINS AND OTHER PIPING.** (a) Sewer or drain pipes, wherever possible, shall not pass directly over areas where food, ice or potable liquids are prepared, handled, stored or displayed. Where building design requires that soil or drain pipes be located below the ceiling of such areas, the installation shall be made with the least possible number of joints and shall be installed so as to connect to a vertical stack at the nearest wall or vertical building support and the construction shall be performed as follows:

1. All openings through floors over such areas shall be provided with sleeves securely bonded to the floor construction and projecting not less than $\frac{3}{4}$ inch above top of finished floor with space between sleeve and pipe or duct sealed.

2. Floor and shower drains installed above such areas shall be equipped with integral seepage pans.

3. Plumbing fixtures in rooms located above such areas shall be of the wall mounted type except bathtubs. Tubs shall have waste and overflow connections made above the floor and piped to trap below floor. All connections through floor and to trap shall conform with all other provisions

of this regulation. No floor openings other than sleeve for waste pipe will be permitted for tubs.

4. All other soil or drain pipes shall be galvanized steel or cast iron with screwed joints sealed with litharge and glycerine or copper tube with soldered joints. Cleanouts shall be extended through the floor construction above.

5. All soil and drain pipes located above such areas shall be subjected to a standing water test of not less than 25 feet.

6. All piping subject to operation at temperatures that will form condensation on the exterior of the pipe shall be thermally insulated.

7. Where pipes are run in ceilings above such areas, the ceiling shall be of the removable type, or shall be provided with access panels in order to form a ready access for inspection of piping unless a lath and plaster ceiling is provided.

8. In lieu of the above, other methods may be approved by the department.

(b) Exposed soil, waste and other drainage pipe lines in a pool or equipment room shall not pass over the pool, surge tank or open filter.

History: 1-2-56; r. (2) through (7), Register, October, 1971, No. 190, eff. 11-1-71; r. and rec. Register, November, 1972, No. 203, eff. 12-1-72; renun. from H 62.14, Register, July, 1983, No. 331, eff. 8-1-83.

ILHR 82.15 Water conserving fixtures. (s. 145.25, Stats.) (1) **TYPES OF WATER CONSERVING FIXTURES.** (a) All water closets, lavatory faucets, urinals and shower heads shall meet the requirements of the following subsections and be of an approved type. Test data shall be submitted based on 50 pounds per square inch water pressure.

(2) **PROHIBITIONS.** (a) *All buildings.* "No person may sell at retail or install in or cause to be installed in any building:"

1. "A water closet which uses more than 4 gallons of water per flush."

2. "A shower head which uses more than 3 gallons of water per minute."

(b) *Public restrooms and public buildings.* No person may install or cause to be installed in any public restroom or public building:

1. "Any urinal intended for use by male persons which is operated by an automatic urinal flush valve or hand-operated flush valve which uses more than 1.5 gallons of water per flush per use."

2. "Any automatic siphon urinal flush tanks."

3. "Any wash basin faucet which allows more than 1 gallon of water to flow through the faucet after the handle is released."

Note: Quotation marks indicate statutory language taken verbatim or paraphrased from s. 145.25, Stats.

(c) *One and 2 family dwelling.* No person may install or cause to be installed, any faucet connected to a wash basin in any private dwelling which allows more than 3 gallons of water per minute to flow through the faucet.

(3) LISTING OF ACCEPTABLE WATER CLOSETS. (a) *Publish*. The department shall publish a list of water closet models which have been manufactured and tested in accordance with recognized standards and which have been certified by the manufacturer to use no more than 4 gallons per flush.

(b) *Manufacturer's responsibilities*. Manufacturers desiring to have their product included on the published list shall submit for each water closet model laboratory test data, engineering data, a certification by the manufacturer that the product meets the standards set forth above and a copy of the sales brochure.

(c) *Manufacturer's listing*. The manufacturer shall submit a list of the make and model of all water closets tested and offered for sale in Wisconsin, regardless of water use.

(d) *Identification*. Each closet shall be permanently marked for identification as required by s. ILHR 82.19.

(4) LISTING OF OTHER WATER SAVING DEVICES. (a) *Shower heads*. The department shall publish a list of shower heads which have been manufactured, tested and certified by the manufacturer to permit not more than 3 gallons per minute to flow through the head.

(b) *Urinals and urinal flushing devices*. The department shall publish a list of all Wisconsin approved urinals and urinal flushing devices which have been manufactured, tested and certified by the manufacturer to permit not more than 1.5 gallons per flush per use to flow through the valve or fixture.

(c) *Faucets in public restrooms and public buildings*. The department shall publish a list of all faucets which have been manufactured, tested and certified by the manufacturer to permit not more than 1 gallon of water to flow through the faucet after release of the handle.

(d) *Faucets for lavatories or wash basins installed in private dwellings*. The department shall publish a list of all faucets which have been manufactured, tested and certified by the manufacturer to permit not more than 3 gallons of water per minute to flow through the faucet.

(e) *Flow control and flow restrictor devices*. 1. Flow control or restricting devices should be installed on the water inlet side of the faucet or have an integral flow control or restrictor.

2. Flow controlling aerators. Flow controlling or restricting aerators may be used in lieu of the recommended control or restricting device when approved by the department.

3. All items listed under sub. (4) shall have a permanent means of identification as required by s. ILHR 82.19.

4. All flow control and flow restrictive devices manufactured, tested and certified by the manufacturer shall limit the flow through the unit to the test and certification rate. They shall not be removable without special knowledge or effort.

(5) EXEMPTIONS. (a) *Availability*. When a water conserving device or fixture is required, the item(s) shall be available from 2 or more manufacturers. When a required water conserving device or fixture is not avail-

able from 2 or more manufacturers, the requirement may be waived subject to departmental approval.

(b) *Waiver*. The department, upon request, may waive compliance with flushing requirements established by s. 145.25, Stats., and this section if the following conditions prevail:

1. Existing buildings. Any building in existence or under construction on or before January 1, 1979, if its drainage system design or installation requires a greater quantity of water to function properly.

2. Public sewer design. If any building is served by a public sewer which requires a greater quantity of water to maintain flow.

History: Cr. Register, April, 1980, No. 292, eff. 5-1-80; renum. from H 62.15, Register, July, 1983, No. 331, eff. 8-1-83.

ILHR 82.16 Health care and related facilities. (1) **PLAN APPROVAL REQUIRED.** Plans for plumbing and equipment for health care facilities shall be approved by the department.

(2) **SCOPE.** The scope of this section shall cover devices, fixtures and equipment which are installed and maintained in health care facilities such as hospitals, nursing or rest homes, homes for the aged, infirmaries, residential care facilities, orphanages, sanitariums, sanatoriums, clinics, mortuaries, and schools of medicine, surgery, dentistry, and research and testing laboratories whether enumerated or not. This section may also apply to offices of dentists and doctors.

(3) **INTENT.** The primary intent of the following minimum requirements is to protect public health by eliminating either potential health or safety hazards to patients and institutional personnel, and to promote the efficient use, operation and maintenance of the equipment used in the institution or establishment. Fixtures, devices and/or equipment in addition to those prescribed herein may be required dependent upon the type of occupancy, treatment, care or layout. Such additional facilities shall be installed in accord with the provisions of this chapter.

(4) **PLUMBING IN MENTAL HOSPITALS.** Special consideration shall be given to the design and installation of plumbing fixtures in areas where disturbed patients are housed. No pipes or traps shall be exposed and all fixtures shall be securely bolted through walls or floors.

(5) **SPECIAL FIXTURES AND EQUIPMENT ACCEPTABILITY.** (a) *Special fixtures.* Fixtures which are designed for any special use such as, therapy, special cleansing and/or disposal of waste materials shall be smooth, impervious, corrosion resistant materials and, if subject to temperatures in excess of 180°F., shall be able to withstand without damage, higher temperatures as may be specified. Scrub-up sinks, lavatories and sinks in patient care areas, and fixtures used by medical and nursing staff, shall have the water supply spout terminate a minimum of 5 inches above the rim of the fixture. These fixtures shall be equipped with valves or faucets which can be operated without use of the hands.

(b) *Special equipment.* All devices, appurtenances, appliances and apparatus intended to serve a special function such as sterilization, distillation, processing, cooling, storage of ice or foods, etc., which may be connected to either the water supply distribution or drainage systems or both, shall be provided with protection against back-siphonage, back-

flow, flooding, fouling, or any possibility of contaminating any portion of the water supply system, or equipment, or the misuse of any drain.

(c) *Therapeutic equipment.* Therapeutic equipment shall not be counted as a patient bathing fixture to meet the required patient bath ratio.

(6) **FIXTURE AND EQUIPMENT INSTALLATION.** (a) *Clinic sinks.* Such fixtures shall have an integral trap in which the upper portion of a visible trap seal provides a water surface. The fixture shall be designed so as to permit complete removal of the contents by siphonic and/or blow-out action, and to reseal the trap in a single flushing operation. A flushing rim shall provide water to cleanse the interior surface. The fixtures shall have flushing and cleansing characteristics similar to a water closet.

(b) *Prohibited use of clinic sinks and service sinks.* A clinic sink shall not be used as a janitor's service sink. A janitor's service sink shall not be used for the disposal of urine, fecal matter, or other human wastes.

(c) *Special requirement for ice manufacture and storage.* 1. No machines for manufacturing ice, or any device for handling or storing ice, shall be located in a room containing a bedpan hopper, clinic sink, bedpan washer, or similar fixture. Machines for manufacturing ice, or devices for handling or storing ice intended for either human consumption or packs, shall be located in a clean utility room, a floor pantry, a diet kitchen, or in other similar locations.

2. Each drain serving an ice chest or box shall discharge into an indirect waste receptor. Each drain shall discharge through an air-break above the receptor. The end of the drain shall be covered with a removable 10 mesh per inch noncorrosive screen.

(7) **STERILIZERS.** (a) *Descaling prohibited.* The interior of water sterilizers, stills, or similar equipment shall not be descaled or otherwise treated by acid or other chemical solutions while the equipment is connected to the water and/or drainage systems.

(b) *Compliance with boiler and pressure vessel code.* Pressure sterilizers and pressure type instrument washer sterilizers installed after the effective date of this code shall be constructed and stamped in accordance with the provisions of Wis. Adm. Code s. Ind 41.50 (1) (e). All pressure sterilizers and pressure type instrument washer sterilizers regardless of size shall be equipped with pressure relief devices in accordance with the provisions of s. Ind 41.50 (1) (e).

(c) *Sterilizer piping.* The connecting piping and/or devices for sterilizers shall be accessible for inspection and maintenance.

(d) *Bedpan washers and clinic sinks.* Bedpan washers and clinic sinks shall be connected to the sanitary drainage system and vented in accordance with the requirements for water closets. Vapor vents serving bedpan washers shall not connect to the plumbing system.

(8) **DRAINAGE AND VENTING.** (a) *Sterilizer wastes.* 1. Indirect wastes required. All sterilizers shall be provided with individual and separate indirect wastes, with air-gaps of not less than 2 diameters of the waste tailpiece. The upper rim of the receptor, funnel, or basket type waste fitting shall be not less than 2 inches below the vessel or piping, which-

ever is lower. Except as provided in subs. 3. and 5., a "P" trap shall be installed on the discharge side of and immediately below the indirect waste connection serving each sterilizer.

2. Floor drain required. In any room containing the recessed, or concealed portions of sterilizers, not less than one acceptable floor drain, connecting to the drainage system, shall be installed in a manner to drain the entire floor area. The floor drain waste and trap shall be a minimum diameter of 3 inches. It shall receive the drainage from at least one sterilizer within the room to assure maintenance of the floor drain trap seal. The sterilizer drain may be installed on a branch taken off between the floor drain trap and the strainer. No individual sterilizer waste trap shall be required on this type-of installation. See following sketch.

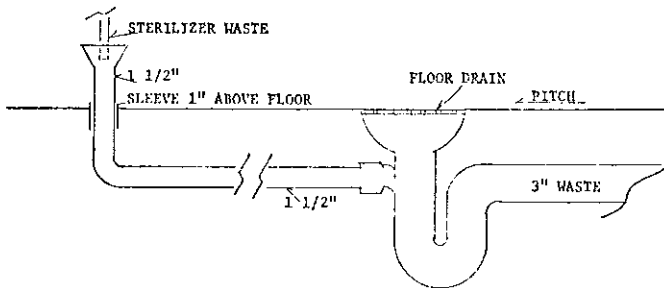

3. Battery assemblies. A battery assembly of not more than 3 sterilizer wastes may drain to one trap, provided the trap and waste are sized according to the combined fixture unit rating; the trap is located immediately below one of the indirect waste connections; the developed distance of a branch does not exceed 8 feet; and the branches change direction through a tee-wye or wye pattern fitting.

4. Bedpan steamers, additional trap required. A trap with a minimum seal of 3 inches shall be provided in a bedpan steamer drain located between the fixture and the indirect waste connection.

5. Pressure sterilizer. Except when an exhaust condenser is used, a pressure sterilizer chamber drain may be connected to the exhaust drip tube before terminating at the indirect waste connection. If a vapor trap is used, it shall be designed and installed to prevent moisture being aspirated into the sterilizer chamber. The jacket steam condensate return, if not connected to a gravity steam condensate return, shall be separately and indirectly wasted. If necessary to cool a high temperature discharge, a cooling receiver, trapped on its discharge side, may serve as the fixture trap.

6. Pressure sterilizer exhaust condensers. The drain from the condenser shall be installed with an indirect waste. If condensers are used on pressure sterilizers, the chamber drain shall have a separate indirect waste connection.

7. Water sterilizer. All water sterilizer drains, including tank, valve leakage, condenser, filter and cooling, shall be installed with indirect waste or according to subd. 2.

8. Pressure instrument washer-sterilizer. The pressure instrument washer-sterilizer chamber drain and overflow may be interconnected. Also, they may be interconnected with the condenser.

(b) *Vapor vent material.* Material for vapor vents serving bedpan washers and sterilizer vents serving sterilizers shall be materials approved for vent piping.

(c) *Vent connections prohibited.* Connections between vapor vents serving bedpan washers, sterilizing apparatus, and/or normal sanitary plumbing systems, are prohibited.

(d) *Vapor vents and stacks.* 1. Bedpan washers shall be vented to the outer atmosphere above the roof by means of one or more vapor vents. The vapor vent for a bedpan washer shall be not less than a 2-inch diameter pipe. A vapor vent serving a single bedpan washer may drain to the fixture served.

2. Multiple installations. Where bedpan washers are located above each other on more than one floor, a vapor vent stack may be installed to receive the vapor vent on the various floors. Not more than 3 bedpan washers shall be connected to a 2-inch vapor vent stack, 6 to a 3-inch vapor vent stack, and 12 to a 4-inch vapor vent stack. In multiple installations, the connections between a bedpan washer vapor vent and a vapor vent stack shall be made by use of a tee or tee-wye sanitary pattern drainage fittings, installed in an upright position.

3. Trap required. The bottom of the vapor vent stack, except when serving only one bedpan washer, shall be drained by means of a trapped and vented waste connection to the plumbing sanitary drainage system. The trap and waste shall be the same size as the vapor vent stack.

4. Trap seal maintenance. A water supply of not less than ¼ inch minimum tubing shall be taken from the flush supply of each bedpan washer on the discharge or fixture side of the vacuum breaker, trapped to form not less than a 3-inch seal, and connected to the vapor vent stack on each floor. The water supply shall be so installed as to provide a supply of water to the vapor vent stack for cleansing and drain trap seal maintenance each time a bedpan washer is flushed.

(e) *Sterilizer vapor vent and stacks.* 1. Connections. Multiple installations of pressure and nonpressure sterilizers shall have their vent connections to the sterilizer vent stack made by means of inverted wye fittings. Such vent connections shall be accessible for inspection and maintenance.

2. Drainage. The connection between sterilizer vent and/or exhaust openings and the sterilizer vent stack shall be designed and installed to drain to the funnel or basket-type waste fitting. In multiple installations, the sterilizer vent stack shall be drained separately to the lowest sterilizer funnel or basket-type waste fitting or receptor.

(f) *Sterilizer vapor vent stack sizes.* 1. Bedpan steamers. The minimum size of a sterilizer vent serving a bedpan steamer shall be 1½ inches in diameter. Multiple installation shall be sized according to table 22.

Table 22

VAPOR VENT STACK SIZES FOR BEDPAN STEAMERS AND BOILING TYPE STERILIZERS

(Number of connections of various sizes permitted to various sized sterilizer vent stacks)

Stack size	Connection size	
	1½"	2"
1½-inch ¹ -----	1 or	0
2-inch ¹ -----	2 or	1
2-inch ² -----	1 and	1
3-inch ¹ -----	4 or	2
3-inch ² -----	2 and	2
4-inch ¹ -----	8 or	4
4-inch ² -----	4 and	4

¹Total of each size.
²Combination of sizes.

2. Boiling type sterilizers. The minimum size of a sterilizer vent stack shall be 2 inches in diameter when serving a utensil sterilizer, and 1½ inches in diameter when serving an instrument sterilizer. Combinations of boiling type sterilizer vent connections shall be based on table 22.

3. Pressure sterilizers. Sterilizer vent stacks shall be 2½ inches minimum; those serving combinations of pressure sterilizer exhaust connections shall be sized according to table 23.

Table 23

VAPOR VENT STACK SIZES FOR PRESSURE STERILIZERS

(Number of connections of various sizes permitted to various sized vent stacks)

Stack size	Connection size			
	¾"	1"	1¼"	1½"
1½-inch ¹ -----	3 or	2 or	1	
1½-inch ² -----	2 and	1		
2-inch ¹ -----	6 or	3 or	2 or	1
2-inch ² -----	3 and	2		
2-inch ² -----	2 and	1 and	1	
2-inch ² -----	1 and	1 and		1
3-inch ¹ -----	15 or	7 or	5 or	3
3-inch ² -----		1 and	2 and	2
3-inch ² -----	1 and	5 and		1

¹Combination of sizes.
²Total of each size.

4. Pressure instrument washer-sterilizer sizes. The minimum size of a sterilizer vent stack serving an instrument washer-sterilizer shall be 2 inches in diameter. Not more than 2 sterilizers shall be installed on a 2-inch stack, and not more than 4 on a 3-inch stack.

(9) FLOOR DRAINS PROHIBITED. Floor drains shall not be installed in operating or delivery rooms.

(10) WATER SUPPLY. (a) *Water services.* All hospitals shall be provided with at least 2 water service connections and whenever more than one street main is available, the connections shall be made to different street mains.

ILHR 82

1. The water service pipe for all other health care facilities shall be of sufficient size to furnish water to the building in the quantities and at the pressures required in s. ILHR 82.13 (4) (d) and (h) 3. [(4) and (5)] and par. (c).

2. Water services shall be in accord with the requirements of s. ILHR 82.13 (2).

(b) *Water distribution control valves.* 1. Four or less patient care units, containing not more than 2 persons per unit exclusive of intensive care coronary units, may be served with one branch control valve. All fixtures, appliances, appurtenances, lawn sprinkler faucets and wall hydrants shall be valved. See following sketch.

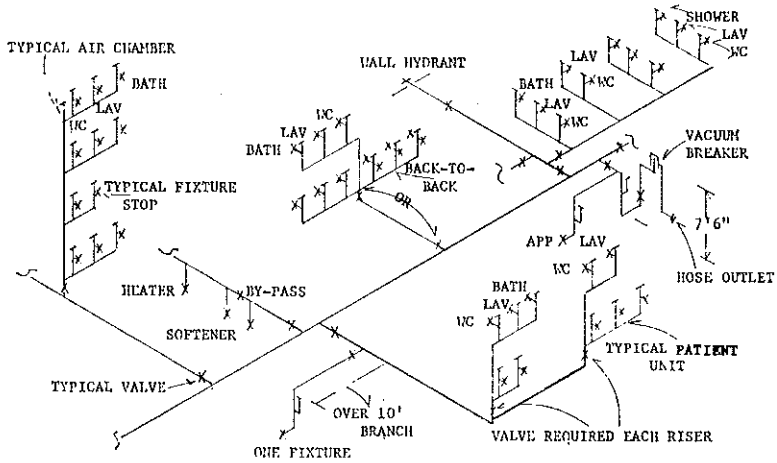

2. Control valves for risers, water heating equipment, water softeners and tank controls shall be in accord with s. ILHR 82.13 (4) (c), (d), (e) and (h) [(4) (j) 2. b. c. d. and g.]. Control valve accessibility and design shall be in accord with s. ILHR 82.13 (4) (f) and (g) [(4) (j) 2. e. and f.]. See above sketch.

(c) *Velocities and flow capacities.* Water supply piping shall be designed to provide service to upper floor installations at a minimum pressure of 15 (p.s.i.) pounds per square inch during maximum demand periods. Velocities shall not exceed 8 (f.p.s.) feet per second. Where static pressure exceeds 80 (p.s.i.) pounds per square inch, pressure reducing controls shall be installed to avoid fracture or other damage to the system. The supply demand in gallons per minute in the building water distribution system shall be determined on the basis of the load in terms of supply fixture units and of the relationship between load and supply demand as shown in table 24 and pertinent portions of tables 13 and 14.

Table 24
DATA FOR ESTIMATING WATER SUPPLY DEMAND AND WASTE REQUIREMENTS

Fixture	Fixture Units				Minimum Pipe Sizes, Inches						Remarks
	Water	Waste	Trap	Vent	Cold Water		Hot Water				
					Water	Waste	Water	Waste			
Water closet (tank).....	6	6	2	2	3/4	3/4	1/2	1/2			
Water closet (flush valve).....	10	8	2	2	1	1	1/2	1/2			H. W. required with bedpan washer hose only
Lavatory.....	3	1	1/4	1/4	1/2	1/2	1/2	1/2			
Urinal (tank).....	3	4	2	1 1/2	1	1	1/2	1/2			
Urinal (flush valve).....	5	4	2	1 1/2	1	1	1/2	1/2			
Shower.....	4	2	3	3	3 FD	3	1/2	1/2			
Patient bath (public).....	4	3	1 1/2	1 1/2	1 1/2	1 1/2	1/2	1/2			
Patient bath (pvt.).....	2	3	1 1/2	1 1/2	1 1/2	1 1/2	1/2	1/2			
Drinking fountain.....	1	1/2	1 1/4	1 1/4	1 1/4	1 1/4	1/2	1/2			
Sitz bath.....	4	3	1 1/4	1 1/4	1 1/4	1 1/4	1/2	1/2			
Clinical sink.....	10	6	3	2	1	1	1/2	3/4			
(Flushing rim).....	4	HW	3	2	1	1	1/2	3/4			
Scrub sink.....	4	3	2	1 1/2	1 1/2	1 1/2	1/2	3/4			2, 3 or 4 place sink
Single sink for misc. hospital use.....	3	3	1 1/4	1 1/4	1 1/4	1 1/4	1/2	3/4			
Double sink for misc. hospital use.....	4	4	2	1 1/2	1 1/2	1 1/2	1/2	3/4			
Laboratory sink.....	2	2	1 1/2	1 1/2	1 1/2	1 1/2	1/2	1/2			
Ice machine.....	1	1	2	1 1/4	1 1/4	1 1/4	3/4	3/4			
Plaster sink.....	6	4	2	1 1/2	2	2	1/2	3/4			Use with plaster trap
X-ray tank.....	4	2	1 1/2	1 1/2	1 1/2	1 1/2	1/2	1/2			Based on 18 x 30 x 22-inch tank
Bedpan sanitizer.....	10	6	2	2	1	1	1/2	1/2			1/2-inch STM connection
Autopsy table.....	4	4	2	1 1/4	1 1/4	1 1/4	1/2	3/4			
Animal area sinks.....	4	4	2	1 1/2	1 1/2	1 1/2	1/2	3/4			
Cup sink.....	1	1	1 1/4	1 1/4	1 1/4	1 1/4	1/2	3/4			

ILHR 82

(d) *Piping insulation.* Circulating, hot, cold and chilled water piping shall be insulated. Cold and chilled water pipe insulation shall have an integral or separate vapor barrier.

(e) *Special piping systems.* Distilled water, ionized water, laboratory and other special piping systems shall be included in the plans submitted. The plans shall incorporate sufficient detail to clearly establish the installation proposed.

(f) *Water supply protection.* The installation of the water supply shall meet all the applicable requirements prescribed in ss. ILHR 82.13 and 82.14, and as provided in table 25 including the corresponding reference number.

Table 25

Equipment	Protective Device	Location	Reference No.
Bath with shampoo nozzle--	Vacuum breaker	6'0" above bottom of tub	1
Bedpan sanitizer-----	Vacuum breaker	Part of flush valve	1
Bedpan washer hose-----	Vacuum breaker	5'9" above floor	1
Hose and faucet at service sink-----	Vacuum breaker	6' above normal use of hose	1
Sterilizer condenser-----	Vacuum breaker	6' above unit	1
Flash washer-----	Vacuum breaker	6' above unit	1
Glove washer-----	Vacuum breaker	6' above unit	1
Stills-----	Air-gap	On discharge	5
Ultrasonic cleaner-----	Vacuum breaker	6" above unit	1
Developing tank-----	Vacuum breaker	6" above unit	1
Dental unit-----	Vacuum breaker	Part of unit	1
Hydrotherapy bath-----	Vacuum breaker	6" above unit	1
Radiology cooling coil (water bath)-----	Air-gap	On discharge	5
Pipette washer-----	Vacuum breaker	6" above unit	1
Laboratory spout-----	Vacuum breaker	At threaded discharge	2
Cage washer-----	Vacuum breaker	6" above unit	1
Tube washer-----	Vacuum breaker	Part of control valve	1
Bottle washer-----	Vacuum breaker	6" above unit	1
Food waste grinder-----	Vacuum breaker	6" above unit	1
Peeler-----	Air-gap	On supply	4
Dishwasher-----	Vacuum breaker	6" above unit	1
Can washer-----	Vacuum breaker	6" above unit	1
Ice machine-----	Air-gap	On discharge	5
Pot washer-----	Vacuum breaker	6" above unit	1
Coffee urn-----	Vacuum breaker	6" above unit	1
Glass washer-----	Vacuum breaker	6" above unit	1
Refrigeration condenser-----	Air-gap	On discharge	5
Clothes washer-----	Vacuum breaker	6" above unit	1
Soap and brine tanks-----	Vacuum breaker	6" above unit	1
Autopsy table-----	Vacuum breaker	6'0" above floor	1
Aspirator-----	Vacuum breaker	6'0" above floor	1
Hose station-----	Vacuum breaker	At threaded discharge	2
Flush rim floor drain-----	Vacuum breaker	5'9" above floor	1
Incinerator gas washer-----	Air-gap	On water supply	5
Lawn sprinklers-----	Vacuum breaker	Outdoor type	1
Wall hydrant-----	Vacuum breaker	At threaded discharge	2
Hose bibb-----	Vacuum breaker	At threaded discharge	2
Package air-conditioner-----	Air-gap	On discharge	5
Cooling tower-----	Backflow preventer	On water supply	3
Boiler make-up water-----	Backflow preventer	On water supply	3
Vacuum pumps and air washing-----	Air-gap	On water supply	4
Spray coil for air washing---	Vacuum breaker	6" above unit	1
Expansion tank-----	Backflow preventer	On water supply	3

1. The designation "vacuum breaker" means a non-pressure, atmospheric type device. The installation elevation means the distance above the spill level of the fixture or equipment served, or the height to which a connected discharge may be raised to cause gravity back-flow to reach the device. The designated installation shall be measured from the bottom of the device, or the critical level marking if indicated on the device. The installation and elevation shall permit the vacuum breaker to drain and actuate each time the control valve is operated. No shut-off valve shall be permitted downstream from the vacuum breaker. The vacuum breaker shall not be installed in a manner so as to be under continuous pressure.

2. The location "at the threaded discharge" means the location where an aerator would normally be installed. The vacuum breaker is the in-line type and for the laboratory faucet the serrated nozzle is then screwed into the discharge end of the vacuum breaker. When this vacuum breaker is used with a hose bibb, it is threaded onto the male end and the hose is connected to the vacuum breaker.

3. The designation "backflow preventer" means the reduced pressure type backflow preventer which includes two spring loaded check valves, a broken connection to a drain and usually two gate valves. The use of this device requires that adequate and rapid drainage be available.

4. An air-gap on the water supply means that the air-gap shall be located at the supply opening to the fixture or equipment it serves. An air-gap is the minimum vertical distance between the supply discharge orifice and the spill level of the receptor, fixture or equipment served. This minimum vertical distance shall be at least 2 diameters of the discharge orifice, or a minimum of one inch, whichever is the greatest.

5. An air-gap on the waste line means an indirect connection between the fixture or equipment and the waste receptor. The waste discharge orifice governs the minimum distance according to subd. 4.

(g) *Hot water supply control.* Hot water supply to patients' showers, therapeutic equipment, and continuous baths shall be provided with control valves automatically regulating the temperature of the water supply to the fixture. The valve shall fail in a closed position when the tempered water supply to the fixture exceeds 110°F.

(h) *Hot water supply.* The water supply distribution system shall be designed to provide hot water at each applicable fixture at all times. The system shall be of a circulating type. The circulating pumps shall be arranged for continuous operation or shall be controlled by an aquastat in the circulating piping. See s. ILHR 82.13 (4) (i) 3 [(4) (f)].

(i) *Water heaters and tanks.* Storage tanks when provided shall be fabricated of non-corrosive metal or be lined with non-corrosive material. The water heating equipment shall have a sufficient capacity to supply water at the temperature and amounts in table 26.

Table 26

	Patient Areas	Clinical	Dietary	Laundry (2 gals. per lb. of laundry)
Gal/hr/bed -----	6½	6½	4	4½
Temp. °F. (Maximum) -----	110°	125°	180°	180°

(11) **ASPIRATORS.** The use of water aspirators shall be limited to those units approved by the department.

(12) **SPOUTS AND ACTIONS—HOSPITAL AND NURSING HOME FIXTURES.**
 (a) The selection of spouts and actions for hospital and nursing home plumbing fixtures shall comply with par. (b) and table 27.

(b) Lavatories and sinks required in patient care areas shall have the water supply spout mounted so that its discharge point is a minimum distance of 5 inches above the rim of the fixture. All fixtures used by medical and nursing staff, and all lavatories used by patients and food handlers shall be trimmed with valves which can be operated without the use of hands. Where blade handles are used for this purpose they shall not exceed 4½ inches in length, except that handles on scrub sinks and clinical sinks shall be not less than 6 inches long.

Table 27

SPOUTS AND ACTIONS FOR HOSPITAL AND NURSING HOME FIXTURES

Location	Type of Spout	Type of Action Minimum
NURSING DEPARTMENT		
Patient toilet room	Gooseneck	Wrist
Patient toilet room— isolation	Gooseneck	Knee
Utility room	Gooseneck	Wrist
Treatment room	Gooseneck	Wrist
Medicine room	Gooseneck	Wrist
Lavatory in floor kitchen	Gooseneck	Wrist
Sink in floor kitchen	Sink faucet	Wrist
Nurses toilet room	Lavatory supply	Hand
Floor laboratory	Laboratory gooseneck	Vertical hand
NURSERY		
Nursery	Gooseneck	Wrist
Suspect nursery	Gooseneck	Wrist
Examination and treatment	Gooseneck	Wrist
Premature nursery	Gooseneck	Foot
Formula room	Gooseneck	Wrist
Labor room	Gooseneck	Wrist
SURGICAL		
Scrub room	Gooseneck with spray head	Knee
Sub-sterile room	Sink faucet	Wrist
Clean-up room	Sink faucet	Wrist
Frozen sections room	Laboratory gooseneck	Vertical hand
Surgical supply room	Gooseneck	Wrist
Work room	Sink faucet	Wrist
Cystoscopic room	Gooseneck with spray head	Knee
Fracture room	Sink faucet	Wrist
Recovery room	Gooseneck	Foot
CENTRAL SUPPLY		
Work room	Sink faucet	Wrist
Solutions room	Sink faucet	Wrist
Needle and syringe room	Sink faucet	Wrist
Glove room	Gooseneck	Wrist
Pharmacy	Laboratory gooseneck	Vertical hand
Manufacturing	Gooseneck	Wrist
EMERGENCY DEPARTMENT		
Observation bedroom	Gooseneck	Wrist
Utility room	Gooseneck	Wrist
Operating room	Gooseneck with spray head	Knee
D.O.A. room	Gooseneck	Wrist
Examination room	Gooseneck	Wrist
DIAGNOSTIC AND TREATMENT		
Occupational therapy	Gooseneck	Wrist
Hydro-therapy room	Gooseneck	Wrist
Examination room	Gooseneck	Wrist
Deep therapy	Gooseneck	Wrist
Superficial therapy	Gooseneck	Wrist
Radium treatment and exam	Gooseneck	Wrist
Toilet room	Gooseneck	Wrist
Dark room	Sink faucet	Hand
Autopsy	Gooseneck with spray head	Knee
Lavatory in autopsy shower room	Gooseneck	Wrist
Laboratories	Laboratory gooseneck	Vertical hand
OUTPATIENT DEPARTMENT		
Examination and treatment room	Gooseneck	Wrist
Dental operating	Gooseneck	Knee
Dental laboratory	Laboratory gooseneck	Vertical hand
Dental recovery	Gooseneck	Wrist
Surgical room	Gooseneck with spray head	Knee
Eye examination room	Gooseneck	Knee
Ear, nose and throat room	Gooseneck	Knee
SERVICE DEPARTMENT		
Lavatory in kitchen	Lavatory supply	Wrist

(13) RADIOACTIVE MATERIALS. See ch. H 57 [HSS 157].

History: 1-2-56; am. (3) (4) and (5), Register, August, 1961, No. 68, eff. 9-1-61; r. and recr. Register, November, 1972, No. 203, eff. 12-1-72; r. and recr., Register, February, 1979, No. 278, eff. 3-1-79; renum. from H 62.16, Register, July, 1983, No. 331, eff. 8-1-83.

ILHR 82.17 Mobile home parks. (1) **PLAN APPROVAL.** (a) *Plans and specifications.* Complete plans and specifications shall be submitted to the department and written approval received before letting contracts or commencing work for all mobile home park sewerage, mobile home park water main and water services and for the addition to or replacement of existing systems.

(b) *Local approval.* The approval by county or other local governmental agency shall not exempt the requirements for state approval for the installation of sewerage and water systems serving mobile home parks.

(c) *Submission of plans and specifications.* All plans and specifications shall be submitted in triplicate and shall include the following:

1. Detailed plan of the proposed sewerage and water system showing mobile home site and service building location with all building sewers and water services indicated.

2. Legal description of the property on which the park is to be constructed.

3. Availability of plans. There shall be maintained at the project site one set of plans bearing the department's stamp of approval.

4. Plans and specifications submitted for private sewage disposal systems shall meet the criteria set forth in ch. ILHR 83.

(2) **MOBILE HOME PARK SEWERAGE SYSTEM.** (a) *General.* The park main sewerage system shall be constructed of materials approved by the department, and installed to limit infiltration of surface or subsoil waters. The infiltration of surface or subsurface waters shall not exceed 200 gallons per inch of diameter per mile per day. See s. ILHR 82.23 (2) (h).

(b) *Design and construction.* 1. **Main sewer size and gradient.** The main sewers shall be sized and graded in accordance with table 30. Main sewers 8 inches or larger shall be designed and constructed to give mean velocity, when flowing full, of not less than 2.0 feet per second, based on Kutter's formula using an "n" value of 0.013. Use of other practical "n" values may be permitted by the department, if deemed justifiable on the basis of research or field data presented.

Table 30

Inside Diameter of Pipe (inches)	Maximum Number Mobile Homes		
	1/16" per ft. slope	1/8" per ft. slope	1/4" per ft. slope
4	None	7	10
5	12	18	24
6	26	34	49

Mobile home parks containing 50 or more homes or sites shall have a minimum 8 inch sewer main.

2. Sewer installation construction shall comply with s. ILHR 82.04.

(c) *Manholes*. A manhole or cleanout shall be installed at the end of each line. Manholes shall be installed at all changes in gradient, size, or alignment; at all intersections; and at distances not greater than 400 feet.

1. Diameter. The minimum diameter of manholes shall be 42 inches.

2. Water tightness. Solid manhole covers shall be used. Manholes of brick or segmented block shall be waterproofed on the exterior by parge-ting with a cement mortar.

3. Terminal manhole. The park sewerage system shall connect to one or more terminal manholes from which the park sewerage system shall extend to a municipal sewerage system or an approved private domestic sewage disposal system. See "Typical Sewerage and Vent System" sketch.

(d) *Cleanouts*. Cleanouts shall comply with the following specifications:

1. All cleanouts shall extend at least 4 inches above established grade.

2. Size. See s. ILHR 82.10 (2).

3. Location. Cleanouts shall be installed with a maximum distance of 100 feet between cleanouts or 200 feet between cleanout and manhole.

4. Protection. Cleanouts shall be surrounded by a concrete slab at least 4 inches thick extending at least 9 inches on all sides, sloping away from the cleanout.

(e) *Mobile home building sewer*. 1. Storm and clear water connections to the park sanitary sewerage system are prohibited. See s. ILHR 82.04 (8) (c).

2. Building sewers—mobile homes. a. Each mobile home site shall be provided with a minimum 4 inch inside diameter building sewer which shall terminate with a 4 inch inside diameter P trap. The trap shall be located within the immediate boundary lines of the pad occupied by the mobile home. Each trap inlet connection shall extend at least 4 inches above final grade and be encased in a concrete pad measuring not less than 4 inches in thickness and 18 inches square. The building sewer shall extend full size to the trap connection which shall be provided with a back vent or a circuit vent. Each trap inlet connection shall be effectively capped or plugged when not in use.

b. Back venting. The developed distance of the horizontal building sewer shall not exceed 48 times the inside diameter of the pipe from the point of vent to the trap weir. See following sketch.

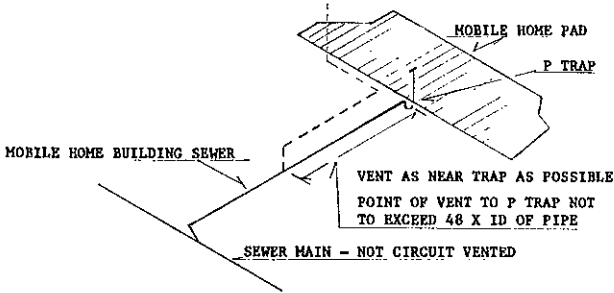

c. Circuit venting. Circuit vents for mobile home P traps shall have a minimum diameter of 4 inches. The size of the circuit vent shall be determined by table 31. Circuit vents shall be constructed as specified in s. ILHR 82.07 (2), except the number of units served shall be determined by table 31. Also, see sketch indicating typical mobile home park sewerage and vent system.

Table 31

Diameter of vent pipe (inches)	Maximum number of mobile homes served by circuit vent
4	15
5	30
6	50

d. Vent terminals. Vents shall terminate either a minimum of 12 inches above the mobile home or not less than 25 feet from any mobile home and terminate with a return bend at least 18 inches above final grade. See following sketch.

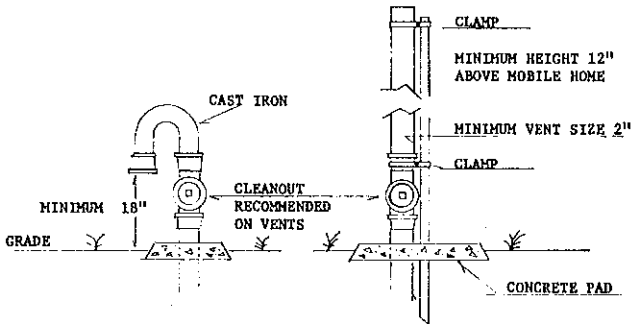

e. Mobile home drain connector. The piping between the soil or waste outlet of the mobile home to the building sewer shall have a minimum pitch of 1/4 inch per foot, be as short as possible, and made gastight and

watertight with rigid or semi-rigid approved materials. all piping should be protected against freezing.

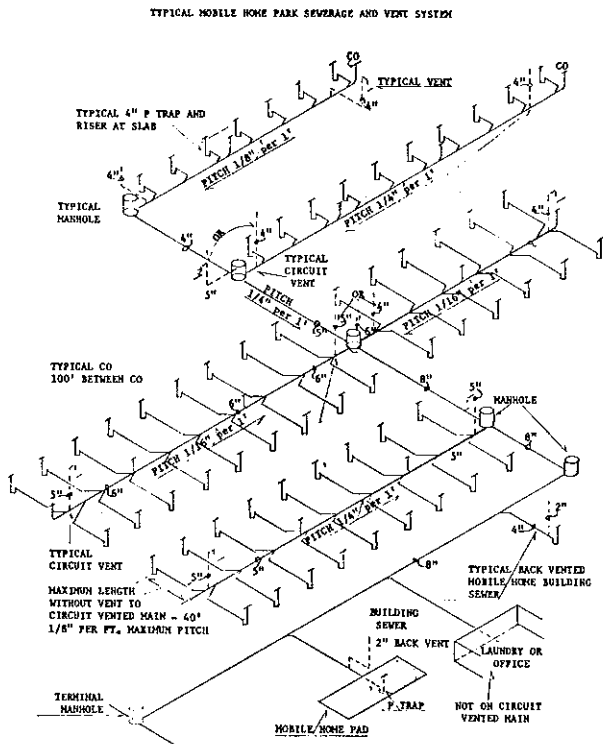

(3) **PARK WATER DISTRIBUTION SYSTEM.** (a) *General.* An adequate supply of potable water shall be supplied to each mobile home site. The minimum pressure within the park distribution main shall be sufficient to maintain 20 psi at each mobile home site. All water distribution mains shall be installed at a depth to prevent freezing.

(b) *Water distribution main.* 1. *Materials.* Water distribution mains shall be type K copper, lead, brass, asbestos cement, cast iron water pipe, galvanized wrought iron, galvanized open hearth iron, galvanized steel, plastic or other materials approved by the department. Any of the above materials used shall be acceptable to the local or municipal water utility.

2. *Valving.* Water distribution mains shall be provided with a gate or full flow valve at its source and at each branch connection. Such valves shall be accessible for operation by installing in valve manholes or stop boxes.

3. *Water and sewer separation.* See s. ILHR 82.13 (2).

(c) *Mobile home water service.* 1. *Size.* Every mobile home site shall be served by a separate water service not less than ¾ inch inside diameter.

2. *Materials.* Materials shall meet the requirements of s. ILHR 82.13 (2) (b).

3. Valving. Each water service shall be provided with: a corporation valve at the main, a curb stop and box located at the site lot line of the parking pad, and a $\frac{3}{4}$ inch inside diameter valve located on the upper end of the water service riser pipe. The water service riser and valve shall extend at least 6 inches above established grade. Underground stop and waste valves are prohibited.

4. Optional riser valves. An approved freezeless type of hydrant with a minimum outlet of $\frac{3}{4}$ inch inside diameter for connection to the mobile home water supply inlet may be used. It shall extend at least 6 inches above the established surface and be protected by a concrete pad at least 4 inches in thickness with an apron extending at least 9 inches on all sides, sloped so that all surface water will drain away from it.

5. Depth of water service and valves. All water service piping shall be protected against freezing.

6. Connection of water service to mobile home. Connection of the mobile home water distribution piping system to the water service riser pipe shall be made with approved materials.

(4) LOCATION OF SEWER INLET AND WATER SERVICE RISER PIPING. The building sewer and water service riser pipes shall terminate in concrete pads located to one side of the rear third of the length of the mobile home hard stand or pad. The water service riser shall extend at least 6 inches above established grade. Each building sewer trap inlet riser shall be encased in a concrete pad measuring not less than 4 inches in thickness and 18 inches square. Each trap inlet connection shall extend not less than 4 inches above final grade and not exceed the elevation of the water service riser valve. See following sketch.

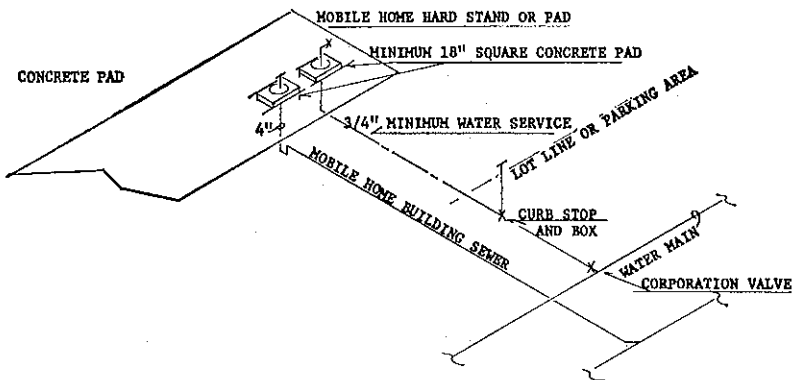

History: 1-2-56; r. and rec. Register, November, 1972, No. 203, eff. 12-2-72; renum. from H 62.17, Register, July, 1983, No. 331, eff. 8-1-83.

ILHR 82.18 Joints and connections. (1) **TIGHTNESS.** Joints and connections in the plumbing system shall be watertight and gastight for the pressure required by test or system design, whichever is greater, with the exception of perforated or open joint piping which is installed for the purpose of collecting and conveying groundwater, seepage water or septic tank effluent to the point of disposal.

(2) **TYPES OF JOINTS.** (a) *Asbestos cement pipe joints.* Asbestos cement pipe joints shall be made with a sleeve type coupling of the same material as the pipe and sealed with 2 rubber rings.

(b) *Bituminized fiber pipe joints.* Bituminized fiber pipe joints shall be made with tapered type couplings of the same material as the pipe or equal.

(c) *Borosilicate glass pipe joints.* Borosilicate glass pipe joints shall be made with a bolt compression type stainless steel (300 series) coupling with contoured Buna-N resilient compression ring and a fluorocarbon inner seal ring.

(d) *Joints on brass pipe.* Joints on brass pipe shall conform to the provisions of par. (i) except that exposed threads do not require coating.

(e) *Cast iron pipe.* 1. Joints in cast iron bell and spigot soil, waste and vent pipe shall be made by first inserting a roll of hemp, oakum or jute and thoroughly caulking in place, and then filled with pure molten lead to a depth of not less than one inch. The lead shall be caulked thoroughly at the inside and outside edges of the joint. No paint, varnish or other coatings shall be permitted on the joining material until after the joints have been tested.

2. Rubber gasket joints in bell and spigot cast iron pipe made by means of a preformed molded rubber ring, secured by pulling the pipe and fittings together in such a way as to compress the molded rubber ring in a manner that will assure a gastight and watertight joint are permitted in underground building sewers and underground building drains. The rubber sealing ring shall conform to A.S.T.M. C-564-70.

3. Joints in cast iron water pipe shall be lead caulked bell and spigot, mechanical joint bell and spigot or push-on bell and spigot conforming to A.W.W.A. C600-64 specifications section 9a, 9b or 9c. When mechanical joint or push-on joints are installed, bonding provision shall be made for electrical thawing.

(f) *Cement mortar joints.* Cement mortar joints are prohibited except for repairs and connections to existing piping installed with such joints. When permitted, cement mortar joints shall be made in the following manner: A layer of jute or hemp shall be inserted into the base of the annular joint space and packed tightly to prevent mortar from entering the interior of the pipe or fitting. Not more than 25% of the annular space shall be used for jute or hemp. The remaining space shall be filled in one continuous operation with a thoroughly mixed mortar composed of one part cement and 2 parts sand with only sufficient water to make the mixture workable by hand. Additional mortar of the same composition shall then be applied to form a 1 to 1 slope with the barrel of the pipe. The bell or hub of the pipe shall be left exposed. When necessary, the interior of the pipe shall be swabbed to remove any mortar or other material which may have found its way into the pipe or fitting.

(g) *Joints in concrete pipe.* Joints in concrete pipe shall be made with rubber type gaskets and conform to A.S.T.M. "Specifications for Joints for Circular Concrete Sewer and Culvert Pipe, Using Flexible, Watertight, Rubber Gaskets", designation C 443-67. For building sanitary sewers, they shall be of an oil resistant type having a maximum swell of

90% when tested in accordance with A.S.T.M. designation D 471-72 in A.S.T.M. Oil No. 3.

(h) *Copper tube and fittings.* 1. Joints for copper tube for soil, waste and vent piping shall be soldered or sweated. The surfaces to be soldered or sweated shall be cleaned bright, properly fluxed and soldered or sweated with noncorrosive 50-50 lead-tin (new metals) or tin-antimony containing 90 to 96% tin and 4 to 10% antimony (95-5).

2. Joints for copper water tube may be soldered, flared or flanged provided that all aboveground water tube which will be concealed shall be soldered or sweated. The process for soldering or sweating shall be as specified in subd. 1. Flared joints, permitted with soft copper, shall be made by the use of a proper flaring tool. Silver soldering will be permitted only on copper water tube installed underground.

(i) *Wrought iron and steel pipe and fittings.* 1. Joints in wrought iron and steel pipe and fittings shall be standard taper pipe thread. All burrs shall be removed. Pipe ends shall be reamed or filed out to full size of bore and all chips removed. All screw joints shall be made with mineral paint or pipe thread compound which is insoluble in water and nontoxic, applied to the male thread.

2. Welded joints are permitted only on black wrought iron or steel pipe aboveground in rainwater conductors with weld type fittings. Mitered joints are prohibited. Joints to be welded shall be free from rust, paint, oil, scale or other objectionable material and the welding performed in accordance with acceptable procedure.

(j) *Hot poured joints.* Hot poured compound joints are prohibited except for repair or replacement where it is impractical to use any other jointing method. Hot poured compound for clay or concrete sewer pipe shall not be water absorbent and when poured against a dry surface shall have a bond of not less than 100 pounds per square inch in shear. All surfaces of the joint shall be cleaned and dried before pouring. If wet surfaces are unavoidable, a suitable primer shall be applied. The compound shall not soften sufficiently to destroy the effectiveness of the joint when subjected to a temperature of 160° F. nor be soluble in any of the waste carried by the drainage system. Approximately 25% of the joint space at the base of the socket shall be filled with jute or hemp. A pouring collar, rope or other device shall be used to hold the hot compound during pouring. Each joint shall be poured in one operation until the joint is filled. Joints shall not be tested until one hour after pouring.

(k) *Wiped joints.* Wiped joints in lead pipe shall have an exposed surface on each side of the joint not less than $\frac{3}{4}$ inch and a minimum thickness at the thickest part of the joint of not less than $\frac{3}{8}$ inch.

(l) *Joints in vitrified clay pipe.* Joints in vitrified clay pipe shall be prefabricated of resilient materials, bonded to the pipe at the producing plant. The resilient materials shall conform to the A.S.T.M. "Specifications for Compression Joints for Vitrified Clay Bell and Spigot Pipe," Designation C425-71. Only virgin materials shall be used. The composition of the jointing material shall be periodically checked after fabrication by an accredited laboratory. Prior to making the installation, the joint material on both the bell and spigot ends shall be wiped clean

and coated with a lubricant. The spigot end shall be inserted into the bell and pressure applied until the pipe is properly seated.

(3) JOINTS BETWEEN DIFFERENT PIPING MATERIALS. Refer to either material in this section.

(a) Asbestos cement pipe. See material to which it is to be joined.

(b) Bituminous fiber. Joints between bituminous fiber and asbestos cement or concrete pipe shall be made by means of a department approved adapter.

(c) 1. Joints between brass, wrought iron or steel and copper or lead shall be made by the use of a copper or brass adapter with standard screw threads.

2. Joints between wrought iron or steel and glass pipe shall be made by the use of a department approved adapter.

(d) 1. Joints between cast iron soil pipe and asbestos cement or bituminous fiber pipe shall be made by the use of a proper adapter and a caulked joint conforming to sub. (2) (e) 1.

2. Joints between cast iron, copper, brass or steel pipe shall be made by the use of a screw thread joint or ferrule and lead caulked joints except a ferrule will not be required when steel pipe and cast iron are of the same diameter.

(e) Joints between vitrified clay tile and asbestos cement, bituminous fiber or cast iron pipe shall be made by the use of a department approved adapter.

(f) Joints between concrete pipe or fittings and asbestos cement, cast iron, vitrified clay, borosilicate glass or lead pipe shall be made by the use of department approved adapters.

(g) 1. Joints between copper tube and vitrified clay or concrete pipe shall be made by soldering or sweating a ferrule or hub onto the copper tube and the use of a department approved adapter.

2. Joints between copper tube and glass pipe shall be made by the use of a copper to American National taper pipe thread adapter and a glass manufacturer's conversion connection.

3. Joints between borosilicate glass and vitrified clay pipe shall be made by acid resistant oakum or hemp and department approved sealing compound.

(h) 1. Joints between borosilicate glass pipe and cast iron bell and spigot or lead pipe shall be made with department approved adapters except a lead caulked joint may be used to join spigot end glass pipe to hub end cast iron pipe of the same diameter.

2. Joints between copper tube and lead pipe shall be made by the use of threaded lead ferrules and screw thread copper or brass adapters.

(i) Joints between lead and cast iron pipe shall be made by means of a wiped joint to a caulking ferrule and lead caulked joint.

(j) Joints between plastic pipe and pipe fittings of other materials shall be made by the use of department approved adapters.

(4) SPECIAL JOINTS. (a) Slip joints. Slip joints using packing or gasket material may be used on the inlet side of a trap or within the dip of the trap, but are prohibited on the sewer side of the trap. See following sketch.

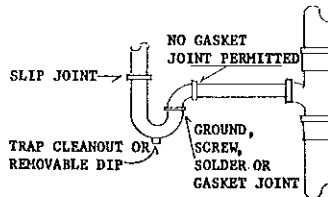

(b) Ground joints. Brass or copper ground faced ferrule type connections which allow adjustment of tubing but provide a rigid joint when made up may be used on the discharge side of a brass tube trap or a fixture water supply but may not be concealed.

(c) Ground faced unions of drainage pattern may be used in waste piping but may not be concealed.

(d) Adapters with IPS thread with caulking hub are permitted in soil, waste and vent piping provided the caulked joint is made in a vertical position.

(e) 1. Fixture connections between drainage pipes and water closets, floor outlet service sinks, wall mounted urinals and earthenware trap standards, shall be made by means of brass, hard lead, or iron flanges soldered, caulked or screwed to the drainage pipe. The connection shall be bolted with an approved gasket, washer or setting compound between the earthenware and the connection. For floor outlet fixtures, the bottom of the flange shall be set on top of the finished floor on a firm base.

2. Wall mounted water closets and wall mounted urinals shall be securely bolted to a carrier fitting. The connecting piping between the carrier fitting and the fixture shall be an approved metal and designed to accommodate an adequately sized gasket. The gasket material shall be graphite impregnated asbestos, felt or similar approved type.

(5) PROHIBITED JOINTS AND CONNECTIONS. (a) *Drainage system.* 1. Any fitting or connection which has an enlargement, chamber or recess with a ledge, shoulder or reduction of pipe area that offers an obstruction to flow through the drains is prohibited.

2. No fitting or connection that offers abnormal obstruction to flow shall be used. The enlargement of a 3 inch closet bend to 4 inch shall not be considered an obstruction.

3. Where different sizes of pipes or pipes and fittings are to be connected, the proper size adapters, increasers, reducers or reducing fittings shall be used between the 2 sizes. Hexagon screwed bushings shall not be used in drainage piping.

(6) **WATERPROOFING OF OPENINGS.** Joints at the roof around vent pipes shall be made watertight by the use of lead, copper, galvanized iron flashings or flashings of other material approved by the department.

Note: Copies of standards promulgated by the following technical societies referred to above are on file in the offices or secretary of state, dept. of industry, labor and human relations and revisor of statutes and may be obtained for personal use from the following addresses:

American Society for Testing and Material
1916 Race St., Philadelphia, Pa. 19103

American Water Works Association
2 Park Avenue, New York, New York 10016

History: 1-2-56; r. and recr. (2) (f), Register, October, 1968, No. 154, eff. 11-1-68, r. and recr. Register November, 1972, No. 203, eff. 12-1-72; renum. from H 62.18, Register, July, 1983, No. 331, eff. 8-1-83.

ILHR 82.19 Materials. (1) **MINIMUM STANDARDS.** (a) Unless otherwise provided for in this chapter, all materials, fixtures or devices sold, used or entering into the construction of plumbing systems or parts thereof, shall be submitted to the department for approval and shall conform to approved applicable standards or to other equivalent standards acceptable to the department and shall be free from defects.

(b) Each length of pipe and each pipe fitting, trap, fixture material and device used in a plumbing system shall have cast, embossed, stamped, or indelibly marked on it the maker's mark or name, the weight and quality of the product or identified in accord with the applicable approved standard. All materials and devices used in the construction of a plumbing system or parts thereof shall be marked and identified in a manner satisfactory to the department.

(c) Standards listed or referred to in this section cover materials which will conform to the requirements of this chapter when used in accordance with the limitations imposed in this or other sections thereof. Designs and materials for special conditions or materials not provided for herein may be used only after the department has been satisfied as to their adequacy and granted approval. Table 32 contains generally accepted and department approved plumbing materials and their applicable standards. See s. ILHR 82.24.

(d) In existing buildings or premises in which plumbing installations are to be altered, repaired or renovated, the department has discretionary powers to permit deviation from the provisions of this chapter provided that such a proposal to deviate is first submitted to the department for proper determination and approval.

(e) The department may require tests to be made or repeated if, at any time, there is reason to believe that any material or device no longer conforms to the requirements on which its approval was based.

(2) **MATERIAL STANDARDS.** (a) *Specification standards.* Each material listed in table 32 shall conform to at least one of the standards opposite it. Products conforming to one or more of the specifications listed shall be considered acceptable subject to limitations specified. See s. ILHR 82.02 (119) for list of abbreviations. For materials not listed, consult the department.

1. Standard strength clay sewer pipe shall not be installed at a depth exceeding 12 feet. See ss. ILHR 82.04 (2) and 82.05 (2).

2. Extra strength concrete pipe in sizes 6 inch through 10 inch or sewers laid at a depth of less than 12 feet. Concrete pipe 12 inches and larger shall be reinforced concrete. See ss. ILHR 82.04 (2) and 82.05 (2).

Table 32

Materials	See Limitations to ILHR 82.19 (2) (a) Below	Standards and Specifications		
		ANSI	ASTM	Other
Asbestos cement—pressure pipe class 150 and class 200			C296-69a	AWWA C400-65
Asbestos cement—nonpressure sewer pipe 8 inch and larger			C428-71	
Asbestos cement—nonpressure sewer pipe 4, 5 and 6 inch			C644-71	
Asbestos cement—storm sewer pipe	14		C663-70	
Asbestos cement—perforated pipe—general drainage			C598-67	
Bituminous fiber sewer pipe—homogeneous			1861-69	
Bituminous fiber sewer pipe—laminated			D1862-64	
Bituminous fiber—homogeneous perforated pipe—general drainage			D2311-69	
Bituminous fiber—homogeneous perforated pipe—septic tank tile fields			D2312-64	
Bituminous fiber—laminated pipe—general drainage			D2417-66	
Bituminous fiber—laminated pipe—septic tank tile fields			D2313-65	
Clay sewer pipe—standard strength—glazed	1		C13-69	
Clay sewer pipe—standard strength—unglazed	1		C13-69	
Clay sewer pipe—extra strength—glazed	1		C200-69	
Clay sewer pipe—extra strength—unglazed	1		C200-69	
Clay pipe—perforated—footing and foundation drains			C211-61T	
Clay drain tile			C4-62	
Concrete sewer pipe—non-reinforced	2		C14-67	
Concrete sewer pipe—reinforced	2		C76-67	
Concrete—perforated pipe			C444-68	
Concrete—drain tile			C412-71	
Corrugated iron or steel pipe	13			F.S. WWP-405a-1968
Cast iron soil pipe and fittings—service and extra heavy	3 & 4		A74-69	Cast Iron Soil Pipe Institute 301-72
Cast iron soil pipe and fittings—No-Hub	5			
Cast iron threaded drain, waste and vent fittings	6	B16.12-1965		
Cast iron soil pipe—threaded		A40.5-1943		
Cast iron water pipe—cast in metal molds				AWWA C106-62
Cast iron water pipe—cast in sand lined molds				AWWA C108-62
Cast iron water pipe pressure fittings				AWWA C110-64
Cast iron pipe flanges and flanged fittings				AWWA C110-64
Cast iron water pipe fittings screwed		B16.4-1963		
High silicon cast iron soil pipe and fittings			A74-69	
Wrought iron pipe			A72-65	
Welded and seamless steel pipe			A53-71a,	
			A120-71	
Malleable iron fittings		B16.3-1963		
Steel pipe flanges and fittings		B16.5-1968		
Nipples threaded				See a. ILHR 82.19 (1) (a) and (c)
Wrought seamless copper and copper alloy pipe and tube—general requirements	7		B251-68a	
Copper pipe—seamless	7		B42-66	
Copper pipe—threadless (TP)	7		B302-66a	
Copper tube—seamless—types K-L-M	7		B88-66a	
Copper drainage tube—type DWV	7		B306-66a	
Copper tube—seamless	7		B75-68	
Cast bronze screwed fittings 125 & 250 lbs.		B16.15-1964		
Cast bronze solder joint pressure fittings		B16.18-1963		
Cast bronze solder joint drainage fittings	8	B16.23-1969		
Bronze flanges & flanged fittings		B16.24-1962		
Wrought copper and bronze solder joint pressure fittings		B16.22-1963		
Wrought copper and bronze solder joint drainage fittings	8	B16.29-1966		
Seamless red brass pipe			B43-66	
Seamless brass tube			B135-67	
Brass fittings for flared copper tube		B16.26-1958		
Acrylonitrile-butadiene-styrene (ABS) Type 1, Schedule 40, DWV and building sewer	9		D1788-68,	NSF 14
			D2661-68	
Acrylonitrile-butadiene-styrene (ABS) (water service)	10		D627-68,	NSF 14
			D2282-68	

Materials	See Limitations to ILHR 82.19 (2) (a) Below	Standards and Specifications		
		ANSI	ASTM	Other
Polybutylene (water service)	10		D2662-68, D2666-68T	NSF 14
Polyethylene (PE) (water service)	10		D2104-68, D2239-68	NSF 14
Polyvinyl chloride (PVC) (water service)	10		D2241-69, D1785-68, D2665-68	NSF 14
Polyvinyl chloride (PVC)	9			NSF 14
Schedule 40 unthreaded				
Schedule 80 can be threaded				
DWV and building sewer				
Solvent cement for acrylonitrile-butadiene-styrene (ABS) plastic pipe and fittings	9		D2235-67	
Solvent cement for polyvinyl chloride (PVC) plastic pipe and fittings	9		D2564-67	
Atmospheric vacuum breakers				ASSE 1001
Caulking materials (water)				AWWA C690-64
Cement lining for cast iron pipe				AWWA C194-64
Coal tar enamel (protective coating)				AWWA C203-66
Ferrous plugs, bushings and locknuts with pipe threads		B16.4-1963		
Galvanized iron and steel sheets			A525-71	
Gel-coated glass-fiber reinforced polyester resin bath units	11	Z124.1		
Gel-coated glass-fiber reinforced polyester resin shower units	11	Z124.2		
Plumbing fixtures—land use	15			F.S. WW-P-54(b) at terim amendments and 6
Precast jointing material for clay pipe				See s. ILHR 82.19 (a) and (c)
Rubber gasket for cast iron soil pipe and fittings	12		C564-68 E38-67	
Sheet brass			B152-66, B248-71	Min. weight—4 lb. sq. ft.
Sheet copper				See s. ILHR 82.19 (a) and (c); ASSE ASSE 1010
Sheet lead				
Soft solder			B32-66T	
Valves			A181-65	
Water hammer arrestors				
Water heaters		C72.1-1949 Z21 10.1-1966 Z21 10.12a-1963		
Manhole frames and covers				See s. ILHR 82.19 (a) and (c)
Septic tanks—general design and accessories				See ch. ILHR 83
Precast concrete and site constructed	16			See ch. ILHR 83
Steel septic tanks	17			See ch. ILHR 83
Glass-fiber reinforced polyester tanks	18			See ch. ILHR 83

3. The wall thickness of fittings and hubs shall correspond with that of the pipe of the same size and kind. Change of direction. 45° elbows, 45° Y and ¼ bend or fittings producing a like radius may be used in lieu of the elbows listed.

4. Cast iron soil pipe fittings. Change in direction. When direction of flow changes from horizontal to vertical, the radius of bends shall be as follows: (All dimensions are given as inches.)

Size of pipe	2	3	4	5	6
Minimum radius	3	3½	4	4½	5

When direction of flow changes from vertical to horizontal or when it is at right angles and changes in the same horizontal plane, the radii of bends shall be as follows: (All dimensions are given as inches.)

Size of pipe	2	3	4	5	6
Minimum radius	8	8½	9	9½	10

5. Building sewer and drain application prohibited. See ch. ILHR 82.

6. Cast iron threaded drainage fittings. The face to center measurements for screw and thread drainage fitting shall be as follows:

PIPE SIZE

1¼"	1½"	2"	2½"	3"	4"
-----	-----	----	-----	----	----

When change of direction is from horizontal to vertical:

2¼"	2½"	3-1/16"	3-11/16"	4¼"	5-3/16"
-----	-----	---------	----------	-----	---------

When change of direction is from vertical to horizontal or horizontal to horizontal:

3"	3½"	4"	4½"	5¼"	6¼"
----	-----	----	-----	-----	-----

Change of direction. 45° elbows, 45° Y and ¼ bend or fittings producing a like radius may be used in lieu of the elbows listed.

7. Copper water tube used for underground water lines may be soft or hard temper. Copper water tube used for interior aboveground water lines shall be hard temper, except concealed vertical tube may be soft temper for repair of replacement lines. Copper tube used for soil, waste and vent piping shall be hard temper. See ss. ILHR 82.05 (2), 82.06 (4), 82.07 (18), 82.13 (2) (b) and (4) (b).

8. Copper, brass and bronze drainage fittings. Change of direction. 45° elbows, 45° Y and ¼ bend or fittings producing a like radius may be used in lieu of the elbows listed.

The radii of wrought copper or cast brass or bronze waste fittings shall be as follows:

PIPE SIZE

1¼"	1½"	2"	2½"	3"	4"
-----	-----	----	-----	----	----

When change of direction is from horizontal to vertical:

1½"	1¾"	2-7/16"		3-5/16"	4¾"
-----	-----	---------	--	---------	-----

When change of direction is from vertical to horizontal or horizontal to horizontal:

2 $\frac{3}{8}$ " 2 $\frac{7}{8}$ " 3 $\frac{3}{8}$ " 4-5/16" 5-3/16"

9. Plastic pipe and fittings—DWV. a. Plastic pipe and fittings shall not be embedded in masonry or concrete and shall be installed exposed or in frame partitions or in accessible tunnels, shafts or crawl spaces. For installations in excess of 3 stories or 35 feet, detailed plans and specifications shall be submitted to the department for approval prior to installation.

b. Schedule 40 plastic pipe and fittings shall not be threaded. When threaded construction is necessary, adapter fittings shall be used to make the transition. Only ABS-DWV socket type fittings shall be used with ABS pipe, and PVC-DWV socket type fittings with PVC pipe. The intermixing of the two type of plastic pipe and fittings is prohibited. The solvent cement for jointing shall meet the requirements of ASTM D-2235-67 for ABS plastic pipe and fittings, and ASTM D 2564-67 for PVC plastic pipe and fittings.

c. An approved plastic expansion joint shall be installed immediately above the cleanout in all vertical soil and waste stacks extending one or more floors in height. When the horizontal offset precedes the vertical rise, an expansion joint shall not be required. See following sketch.

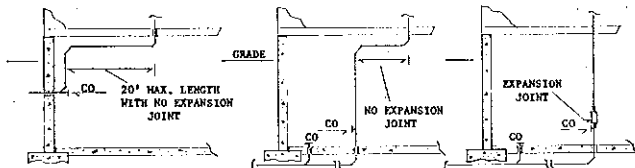

All stacks or piping extending through the roof of the structure shall terminate with an approved expandable type roof terminal flashing or an approved no-caulk neoprene ring roof flashing.

d. All pipe and fitting materials are to be identified as set forth in ASTM Standards D 2661-68 and D 2265-68.

10. Plastic water service piping. a. Plastic water service piping may be installed for cold water only. The use of plastic water service piping from the water main in the street to the curb stop is subject to water department ordinances or local governmental acceptance. Plastic water service piping entering the building shall terminate within 5 feet inside the point of entering the building.

b. The plastic pipe, fittings and solvent cements shall be approved by the National Sanitation Foundation for potable water supply and bear the NSF seal of approval. They also shall comply with the applicable ASTM standards.

c. The plastic pipe and fittings shall have a pressure rating of no less than 160 pounds per square inch; pipe 2 inches and larger shall have a safety factor ratio of 4 to 1 and shall require approval by the department prior to installation. The pressure rating shall be marked on the pipe.

d. Electric grounding to water distribution systems which have utilized plastic water service piping is prohibited.

e. Plastic materials shall be installed according to manufacturer's recommendation or applicable ASTM Standards.

11. Gel-coated fiberglass bath and shower units. All units shall be approved by the department. All nonexposed areas, those not gel-coated, shall have an outer coating of self-extinguishing resin at least 3/32 of an inch in thickness or shall be constructed entirely of self-extinguishing resin. The resin shall be rated self-extinguishing according to ASTM D 635-68. Domes or ceilings shall meet the same specifications. If wood or other materials are used for structure stability or sound deadening, the material used shall be completely enclosed with self-extinguishing resin. When urethane foam is used, it shall meet ASTM D 1692-68 rating as self-extinguishing.

12. See s. ILHR 82.18 (2) (e) 2.

13. Corrugated steel pipe may be used for storm building sewers subject to the following conditions:

a. The pipe is sized according to tables 11, 11a, 11b and 12, s. ILHR 82.12, with adjustments considered to allow for flow characteristics and configuration of the pipe.

b. The connection from a building storm drain to a corrugated steel building storm sewer shall be made at least 10 feet outside the building wall or foundation.

14. Asbestos cement storm drainage pipe conforming to ASTM C663-70 may be installed for storm sewers from a point at least 10 feet outside the building wall or foundation.

15. Brass tubing. All brass tubing used for fixtures, traps and overflows between wall or floor and fixtures shall be made of seamless brass tube with a thickness of at least 0.0453 inch (No. 17 Brown and Sharpe gauge) and shall conform to A.S.T.M. "Standard Specifications for Seamless Brass Tubes," serial number B-135-67.

16. Precast concrete and site constructed tanks. a. Precast concrete tanks shall have a minimum wall thickness of 2 inches.

b. Materials and joints. The concrete used in constructing a precast or site-constructed tank shall be a mix to withstand a compressive load of at least 3,000 pounds per square inch. All concrete tanks shall be designed to withstand the pressures to which they are subjected.

c. The floor and sidewalls of site-constructed concrete tank shall be monolithic except a construction joint will be permitted in the lower 12 inches of the sidewall of the tank. The construction joint shall have a keyway in the lower section of the joint. The width of the keyway shall be appropriately 30% of the thickness of the sidewall with a depth equal to the width. A continuous water stop or baffle at least 6 inches in width shall be set vertically in the joint, embedded 1/2 its width in the concrete below the joint with the remaining width in the concrete above the joint. The water stop or baffle shall be copper, neoprene, rubber or polyvinylchloride designed for this specific purpose.

ILHR 82

d. Joints between the concrete septic tank and its cover and between the septic tank cover and manhole riser shall be tongue and groove or shiplap type and sealed watertight using neat cement, mortar or bituminous compound.

17. Steel septic tanks. For general tank design see s. H 62.20 (4) (a) and (b) [ILHR 83] and subd. 17. Steel tanks shall be fabricated of new, hot rolled commercial steel. The tanks including cover with rim, inlet and outlet collars and manhole extension collars shall be fabricated with welded joints in such manner as to provide structural stability and water tightness. Steel tanks shall be coated, inside and outside in compliance with U.L. Standard 70 Bituminous Coated Metal Septic Tanks. Any damage to the bituminous coating shall be repaired by recoating. The gauge of the steel shall be as follows:

Septic Tank Capacity

Tank Design

Vertical Cylindrical

500 thru 1,000 gallons.....	Bottom and sidewalls	14 ga	None
.....	Cover	12 ga	
.....	Baffles	12 ga	
1,001 thru 1,250 gallons.....	Complete tank	10 ga	None
1,251 thru 1,500 gallons.....	Complete tank	7 ga	None

Horizontal Cylindrical

500 thru 1,000 gallons.....	Complete tank	13 ga	54" dia
1,001 thru 1,500 gallons.....	Complete tank	12 ga	64" dia
1,501 thru 2,500 gallons.....	Complete tank	10 ga	76" dia
2,501 thru 9,000 gallons.....	Complete tank	7 ga	76" dia
9,001 thru 12,000 gallons.....	Complete tank	½" plate	None
12,001 or more gallons.....	Complete tank	5/16" plate	None

18. Glass-fibre reinforced polyester septic tanks. a. General. The following paragraphs apply to septic tanks made of glass-fiber reinforced polyester and intended for use in nonindustrial private domestic sewage treatment and disposal systems. For general septic tank design see s. H 62.20 (4) (a) and (b) [ILHR 83]. Unless otherwise indicated, the plastic terminology used in this section is in accordance with the definitions given in ASTM Standard D 883.

b. Materials. Septic tanks, covers, baffles, flanges, manholes, etc., shall be made from polyester resins with glass-fiber reinforcement and meet the general design criteria as prescribed in (4) (a) of this section.

c. Resin. The resin shall be a commercial grade of polyester resin and shall be evaluated as a laminate by tests conducted in accordance with ASTM Standard C 581. Unless otherwise approved by the department the same resin shall be used throughout the laminate.

d. Reinforcing material. The reinforcing material shall be of a suitable commercial grade of glass-fiber (E Glass) treated with a coupling agent, approved by the glass-fiber manufacturer, that will provide a compatible bond between the resin and the glass. Glass-fiber surfacing materials, is used, shall be of a chemical-resistant glass (C glass) bonded with a suitable binder.

e. Fillers and pigments. The resins used shall not contain fillers except as required for viscosity control. Up to 5% by weight of the total resin content of thixotropic agent that will not interfere with visual inspection may be added to the resin for viscosity control. Resins may contain pig-

ments and dyes recognizing that such additions may interfere with visual inspection of laminate quality.

f. Laminate. The laminate shall consist of the following.

1) Primary chemical-resistant surface.

2) Internal anti-wicking barrier.

3) Additional structural reinforcing section if required to meet the properties described in subsection n. below and the following table.

4) Exterior surface.

1) Primary Chemical-Resistant Surface

2) Internal Anti-Wicking Barrier

1)	2)	2)	3)	3)	3)	To Desired Thickness For Strength	3)	3)	3)	3)	4)
----	----	----	----	----	----	---	----	----	----	----	----

3) Additional Structural Reinforcing Section

4) Exterior Surface

g. Primary chemical-resistant surface. This surface shall be between 0.005 and 0.012 inch thick. It shall be a reinforced resin-rich surface. It shall be free from cracks and crazing and have a smooth finish.

h. Internal anti-wicking barrier. Not less than 0.100 inch of chemical-resistant laminate next to the inner surface shall be reinforced with not less than 20% nor more than 30% by weight of mat or chopped strand.

i. Additional structural reinforcing section. This layer or body or the laminate shall be of chemically resistant construction suitable for the intended use and providing the additional strength necessary to meet the tensile and flexural requirements. Where separate layers such as mat, cloth or woven roving are used, all layers shall be lapped at least one inch. Laps shall be staggered as much as possible. If woven roving or cloth is used, layers of chopped strand glass shall be placed as alternate layers.

j. Exterior surface. This surface shall consist of a chopped strand glass over which shall be applied a resin-rich coating. This resin-rich surface layer shall contain less than 20% of reinforcing material.

k. Cut edges. All cut edges shall be coated with resin so that no glass fibers are exposed and all voids are filled. Structural elements having edges exposed to the chemical environment shall be made with chopped strand glass reinforcement only.

l. Wall thickness. The minimum wall thickness shall be as recommended by the manufacturer but in no case shall it be less than 3/16 inch regardless of operating conditions. Isolated small areas may be as thin as 80 percent of the specified minimum wall thickness.

m. Mechanical properties. To establish proper wall thickness and other design characteristics, the minimum physical properties for any laminate shall be as shown in the following table and subpar. n. below.

**Requirements for Properties of Newly Fabricated
Reinforced Polyester Laminates**

Property at 73.4° F. in psi (MPa)*	THICKNESS IN INCHES				Test Method
	3/16	1/4	5/16	3/8 & up	
Ultimate tensile strength, min.	9,000 (62)	12,000 (83)	13,500 (93)	15,000 (103)	ASTM D 638
Flexural strength, min.	16,000 (110)	19,000 (131)	20,000 (137)	22,000 (152)	ASTM D 790
Flexural modulus of elasticity (tangent), min.	700,000 (4823)	800,000 (5512)	900,000 (6201)	1,000,000 (6895)	ASTM D 790

* (MPa) = mega pascals

n. Surface hardness. The laminate shall have a Barcol hardness of at least 90% of the manufacturer's minimum specified hardness for the cured resins when tested in accordance with ASTM D 2583. This requirement applies to both interior and exterior surfaces.

o. Appearance. The finished laminate shall be as free as commercially practicable from visual defects such as foreign inclusions, dry spots, air bubbles, pinholes, pimples and delamination. The inner surface shall be free from cracks and crazing and have a smooth finish and an average of not more than 2 pits per square foot providing the pits are less than 1/8 inch diameter and not more than 1/32 inch deep and are covered with sufficient resin to avoid exposure of inner surface fabric. Some waviness is permissible provided the surface is smooth and free from pits. Unless otherwise specified, ASTM D 2563 visual acceptance level 3 shall be the minimum standard for acceptance.

p. Tank design. All tanks shall meet the general design criteria as outlined in section H 62.20 (4) (a) and (b) [ch. ILHR 83]. Horizontal cylindrical tanks standard end enclosed shall be convex heads with a maximum radius of curvature equal to the tank diameter. Rectangular tanks shall have external ribs to prevent sidewall deflection exceeding 1/2% of span at any location when tested by filling with water.

q. Shell joints. Where tanks are manufactured in sections and joined by use of a laminate bond, the joint shall be glass-fiber reinforced resin at least the thickness of the heaviest section being joined. The reinforcement shall extend on each side of the joint a sufficient distance to make the joint at least as strong as the tank wall, and shall be not less than the minimum joint widths specified in the following table. The reinforcement shall be applied both inside and out, with the inner reinforcement considered as a corrosion resistant barrier only and not structural material.

**Minimum Total Widths of Overlays for Reinforced-Polyester
Tank Shell Joints**

Tank wall thickness in inches	3/16	1/4	5/16	3/8	7/16	1/2	9/16	5/8	11/16	3/4
Minimum outside overlay width in inches	4	4	5	6	7	8	9	10	11	12
Minimum inside overlay width in inches	4	4	5	5	6	6	6	6	6	6

r. Resistance to static load. There shall be not more than 0.25% difference in dimensions before and after the tanks are statically loaded. For the static load test bed an empty tank in dry sand to a depth not exceeding 4 inches and oriented as in service. Load top segment of empty tank with evenly distributed load to a total weight in pounds equal to:

$$L = 140 \times A_1 \times b$$

where L = total load
 A_1 = horizontal cross-sectional area of tank
 b = depth of overburden expected

Rotate tank through 90° on its major axis. Bed tank in dry sand to a depth not exceeding 4 inches. Load sides of empty tank with evenly distributed load to total weight in pounds equal to:

$$L = 70 \times A_2 \times b$$

where L = total load
 A_2 = vertical cross-sectional area of tank
 b = depth of overburden expected

s. Siphoning or pumping. There shall be no permanent deflection or change in length of any internal or external component of the tank during the pumping or siphoning when the tank is filled to its working level. There shall be no signs of leaking, weeping or other failure.

t. Weight. No tank shall differ in gross weight by more than +10 or -5% from the weight of tanks that have been subjected to the tests for siphoning and static pressure.

u. Tests. Tensile strength test shall in accordance with ASTM C 638, except that the specimens shall be the actual thickness of the fabricated article and the width of the reduced section shall be one inch. Other dimensions of specimens shall be as designated by the ASTM standard for type one specimens for materials over 1/2 inch to one inch inclusive. Specimens shall not be machined on the surface. Test 5 specimens at 0.20 to 0.25 inch/minute crosshead speed, and average the results. Flexural strength shall be determined in accordance with Procedure A and Table 1 of ASTM D 790, except that the specimens shall be actual thickness of the fabricated article and the width shall be one inch. Other dimensions of specimens shall be as designated by the ASTM standard. Specimens shall not be machined on the surface. Test 5 specimens, with the resin-rich side in compression. Determine the tangent modulus of elasticity in flexure by ASTM D 790.

(b) *Miscellaneous materials.* 1. Backwater valves. Backwater valves shall have cast iron or brass bodies, noncorrosive bearings, seats and self-aligning disks, and shall be so constructed as to insure a positive mechanical seal and to remain closed, except when discharging wastes. Such valves shall remain sufficiently open during periods of low flows to avoid screening of solids and shall not restrict capacities or cause excessive turbulence during peak loads. Valve access covers shall be bolted type with gasket and each valve shall bear the manufacturers name cast into the body.

2. Caulking ferrules. a. Caulking ferrules for lead pipe or copper tube to cast iron shall be of red brass, free from sand holes, flaws or other defects, uniform in thickness, and at least 4½ inches long, of a size and weight as shown in table 33.

Table 33

Inside Diameter, Inches	Weight
1½	1 lb. 1 oz.
2	1 lb. 4 oz.
3	1 lb. 14 oz.
4	2 lb. 8 oz.
5	3 lb. 0 oz.
6	3 lb. 8 oz.

b. Caulking ferrules for connection between national taper pipe thread and cast iron pipe shall be brass or cast iron. Brass ferrules shall conform to subd. 2. a. as to materials. Cast iron ferrules shall conform to s. ILHR 82.10 (5), table 7.

3. Cleanout ferrules and plugs. See s. ILHR 82.10 (5) (a) and (7).

4. Closet bolts, nuts and screws for floor outlet fixtures connecting to a floor flange shall be brass or copper. Bolts and nuts for wall outlet fixtures shall be brass or corrosive resistant plated steel.

5. Dishwasher air-gaps as approved by the department.

6. Floor flanges for water closets and similar fixtures shall be brass not less than ⅛ inch thick, cast iron not less than ¼ inch thick or galvanized malleable iron, hard lead or other material approved by the department. Caulked-on flanges shall have a caulking depth of at least 2 inches.

7. Footing, foundation and groundwater collecting piping within a building shall be asbestos cement, bituminous fiber, cast iron, concrete, vitrified tile or other material approved by the department.

8. Lead soil, waste and vent piping shall be the best quality drawn lead pipe, having a minimum weight per foot as follows:

Inside diameter, inches	1¼	1½	2	3	4
Weight per foot, pounds	2½	3½	4¾	6	8

Lead traps and lead bends shall have a minimum wall thickness of ¼ inch. Lead water piping shall have minimum weights as indicated in table 34.

Table 34

Inside diameter, inches	Weight lbs. per foot	Wall thickness inches
⅜	2
½	2
⅝	3
¾	3½	.231
1	4¾	.246
1¼	7¾	.320
1½	11¼	.386
2	10½	.504

Sheet lead for safin g pans shall weigh not less than 4 pounds per square foot. Sheet lead for flashings and roof terminals shall weigh not less than 3 pounds per square foot.

9. Solder bushings shall be red brass with minimum weights as follows:

<i>Pipe size inches</i>	<i>Minimum weight each</i>
1¼	6 oz.
1½	8 oz.
2	14 oz.
2½	1 lb. 6 oz.
3	2 lb. 0 oz.
4	3 lb. 8 oz.

10. Sheet copper for the following uses: a. General use including safe pans—minimum 12 ounces per square foot.

b. Flashings for vent terminals—minimum 8 ounces per square foot.

11. Galvanized sheet iron or steel for vent terminal flashings shall not be lighter than number 28 Brown and Sharpe gauge.

Note: Copies of standards promulgated by the following technical societies, referred to above are on file in the offices of secretary of state, dept. of industry, labor and human relations and revisor of statutes and may be obtained for personal use from the following addresses:

American National Standards Institute, Inc.
1430 Broadway, New York, New York 10018

American Society for Testing and Material
1916 Race St., Philadelphia, Pa. 19103

American Water Works Association
2 Park Avenue, New York, New York 10016

Cast Iron Soil Pipe Institute
2029 K Street, NW
Washington, D.C. 20006

ILHR 82

National Sanitation Foundation
Testing Laboratory, Inc.
P.O. Box 1468
Ann Arbor, Michigan 48106

American Society of Sanitary Engineering
960 Illuminating Building
Cleveland, Ohio 44113

History: 1-2-5; r. and recr. Register, November, 1972, No. 203, eff. 12-1-72; cr. (2) (a) 16, 17 and 18, Register, July, 1976, No. 247, eff. 8-1-76; am. (2) (a) 17, Register, July, 1977, No. 259, eff. 8-1-77; renum. from H 62.19, Register, July, 1983, No. 331, eff. 8-1-83.

H 62.20 Private domestic sewage treatment and disposal systems. **History:** 1-2-56; am. (1) (f), Register, June, 1956, No. 6, eff. 7-1-56; am. (2) (a), (2) (b), (2) (c) 2, Register, February, 1957, No. 14, eff. 3-1-57; am. (1) (b), (d) and (e), Register, April, 1962, No. 76, eff. 10-1-62; r. and recr. Register, November, 1969, No. 167, eff. 12-1-69; am (5) (d) 2.e., Register, October, 1971, No. 190, eff. 11-1-71; r. and recr. (2) (b), Register, November, 1972, No. 203, eff. 12-1-72; r. and recr. Register, July, 1976, eff. 8-1-76; am. (2) (e) 7, cr. (3) (f) and (11), Register, January, 1979; emerg. renum. to ch. H 63 and r. and recr. eff. 6-21-80, r. Register, December, 1980, No. 300, eff. 1-1-81.

Note: Chapter ILHR 83 contains rules on private sewage systems.

ILHR 82.21 Hangers and supports. (1) GENERAL. All piping in a plumbing system shall be installed without undue strains and stresses and provisions shall be made for expansion, contraction and structural settlement and backgrounds where necessary.

(2) **PIPE SUPPORTS.** (a) *Stacks.* All pipes shall be supported so that alignment is retained and the weight of the pipes shall not bear upon a caulked joint, except where the spigot end of one vertical pipe rests in the hub end of the next lower vertical pipe. All vertical stacks extending 3 floors or more in height shall be supported on concrete or masonry piers. All vertical piping shall be provided with an approved support at each floor or approximately every 10 feet.

(b) *Pipe supports—water distribution.* All piping shall be supported to prevent undue strains upon connections or fixtures and shall be so aligned and graded that the entire system or parts thereof can be controlled and drained. The formation of traps and/or sags in water piping shall be avoided where possible. When unavoidable, such sags, traps or inverts shall have provisions for properly draining same.

(3) **HANGERS.** (a) All horizontal piping above the floor shall be supported or anchored by approved wall brackets, copper, iron or steel hangers, concrete or masonry piers set at intervals not to exceed 10 feet. Cast iron pipe shall be supported at the joint and intervals not to exceed 5 feet. Copper tubing shall be supported at approximately 6 feet for piping 1¼ inches inside diameter and less, and at intervals not to exceed 10 feet for piping 1½ inches inside diameter and larger. Lead pipe shall be supported in its entirety. Bracket, hanger and support materials in contact with the pipe or tubing shall be compatible. Plastic DWV piping shall be supported at intervals of not more than 4 feet, at the end of branches and change of direction or elevation. Supports shall allow free movement. Vertical piping shall be maintained in a straight alignment. Support trap arms in excess of 3 feet in length as close as possible to the trap. Closet rings shall be securely fastened with corrosive resistant fasteners to the floor. Closet bends or stubs shall be stabilized against all horizontal or vertical movement. Pipe exposed to damage by sharp surfaces shall be protected with grommets or sleeves of rubber or plastic. Hangers and straps shall not compress, distort, cut or abrade the piping and shall al-

low free movement of pipe. All horizontal piping exceeding 20 feet in length shall have an approved ABS or PVC expansion joint installed. See following sketch.

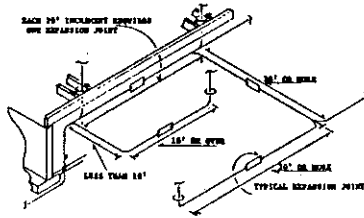

(b) Metal hangers used on pipe or tubing in excess of 4 inches inside diameter shall be of ring and rod, trapeze or other approved type. Perforated band iron or extension bar a minimum of $\frac{3}{4}$ inch wide and 20 gauge thickness may be used for pipe and tubing 2 inches inside diameter and less, and a minimum of $\frac{7}{8}$ inch wide and 18 gauge thickness for pipe and tubing $1\frac{1}{4}$ to 4 inches inside diameter inclusive. Bolts screws and anchors shall be of sufficient strength to sustain their proportional share of the pipe weight and contents and maintain alignment. Approved wire hooks will be allowed for pipe and tubing one inch inside diameter and less.

(c) *Concrete inserts.* 1. In concrete construction, approved inserts set in the concrete may be installed for the support of hangers. The use of wood plugs is not permitted.

2. Hangers should be installed without regard to the support of the sleeves where pipes are run through concrete beams. Such sleeves should not normally be used for the support of pipes.

3. Expansion shields for supporting pipes under concrete construction should preferably be used in a horizontal position in the sides of beams, but in good, sound concrete having gravel or crushed stone aggregate, they may be used in the vertical position to support pipes 4 inches or less in diameter. In all cases, the suitability of the concrete shall be determined before using expansion shields. Where increaser couplings are used, they shall be attached immediately adjacent to the expansion shield.

4. For the support of pipes 4 inches and larger, expansion shields if used in the vertical position shall alternate with hangers connected directly to the structural members such as trusses and girders, or to the sides of concrete beams. In the absence of convenient structural members, pipes 4 inches and larger may be supported entirely by expansion shields in the vertical position, but spaced not over 10 feet apart.

5. Expansion shields shall not be used in ceilings of gypsum, cinder concrete or similar soft material.

6. Expansion shields used in the vertical position shall have holes made of the proper size and be drilled with care to provide for a uniform contact with the shield over its entire circumference. Depth of the hole shall in no case be less than specified for the type of shield used.

7. Holes for shields in the side of concrete beams shall ordinarily be above or as close to the center line as possible.

8. Where pipes are run through concrete beams, sleeves shall be at least one size larger than the piping used.

(4) **BACKGROUNDS.** Substantial backgrounds or approved manufactured supporting devices shall be provided for all fixtures.

History: 1-2-56; r. and recr. Register, November, 1972, No. 203, eff. 12-1-72; renum. from H 62.21, Register, July, 1983, No. 331, eff. 8-1-83.

ILHR 82.22 Repairs and reconstruction. (1) **GENERAL.** Whenever it shall appear upon inspection that any part of an existing plumbing system is defective, or fails to conform to the requirements of this chapter and by reason of such failure tends to create a health hazard, it shall be repaired, renovated, replaced or removed.

(2) **FIXTURES REPLACED.** When an old or defective fixture is removed, to be replaced by a new one, and no other fixture or piping is to be added or remodeled, it will not be necessary to reconstruct the soil, waste or vent piping to make it conform to this chapter, unless the same is in a defective condition. In such cases, if found necessary, the fixtures shall be provided with efficient deep seal traps or deep seal resealing traps of the self-scouring centrifugal type.

(3) **RECONSTRUCTION.** When old or defective plumbing is to be remodeled, additional fixtures installed or the whole plumbing system moved to another part of the building, the remodeled system shall be made to conform to this chapter.

(4) **MATERIALS RE-USED.** All fixtures, soil, waste and vent pipes removed from a building, if found to be in good condition, may be used in the same building or may be used in another building, provided they are approved by the department or local plumbing inspector and the owner of the building in which they are to be installed gives his written consent.

(5) **EXISTING BUILDING SEWERS AND DRAINS.** Existing building sewers and drains may be used in connection with new buildings only when they are found on examination and test to conform to the requirements of this chapter governing building sewers and drains. If the existing work is found defective, the local or state inspector shall notify the owner of the changes necessary to make it conform to the requirements of this chapter.

(6) **REPAIRS.** All repairs to fixtures or piping shall be done in a substantial, sanitary and workmanlike manner.

History: Cr. Register, November, 1972, No. 203, eff. 12-1-72; renum. from H 62.22, Register, July, 1983, No. 331, eff. 8-1-83.

ILHR 82.23 Inspection and tests. (1) **APPROVED INSTALLATIONS.** Plumbing installations in newly annexed territory complying with the requirements of this chapter shall be approved by the local governing body of the municipality of which such territory becomes a part, and the owner of the property shall be granted permission to connect to the public water supply and sewerage system upon the payment of permit fees where such fees are required.

(2) **LOCAL INSPECTION.** (a) *Testing.* All piping of a drainage or plumbing system in cities and villages having local plumbing supervisors, except in case of repairs as specified in sub. (6), shall be tested by the plumber in charge, in the manner herein provided, in the presence of the local supervisor of plumbing or his authorized deputies. The material and labor for tests shall be furnished by the plumber in charge.

(b) *Notice for inspection.* The plumber in charge or the owner of the single family residential property [145.06 (4), Stats.], in case no plumber is employed, shall notify the supervisor in person, by telephone or in writing when the work is ready for inspection. If the inspection is not made by the end of the normal work day following notification, not including Saturday, Sunday or legal holidays, the plumber in charge or the owner may proceed with the work.

(c) *Preparations for inspection.* When work is ready for inspection, the plumber in charge, or in case none is employed, the owner, shall make such arrangements as will enable the supervisor to inspect all parts of the plumbing system. The plumber or owner shall have present the proper apparatus and appliances for making the tests, and shall furnish such assistance as may be necessary in making proper inspection.

(d) *Building drain tests.* The entire building drain with all its branches, receptacles and connections shall be brought so far as practicable to the surface or grade of basement floor and tested with water or air.

(e) *Storm water and clear water piping systems.* Rainwater conductors, roof connectors and clear water waste piping systems shall be tested with water or air.

(f) *Roughing in tests.* All work known as "roughing in" and "underfloor work" between the building drain connections to points above the finished floor and beyond the finished face of walls and partitions shall be tested.

(g) *Water and air test.* 1. *Water test.* The water test shall be applied to the drainage system in its entirety or in sections. If applied to the entire system, all openings shall be tightly closed, except the highest openings above the roof, and the system filled with water to the point of overflow above the roof. If the system is tested in sections, each opening shall be tightly plugged, except the highest opening of the section under test, and each section shall be filled with water. No section shall be tested with less than a 10 foot head of water or a 5 pound per square inch air pressure. In testing successive sections, at least the upper 10 feet of the next section shall be retested so that no joint or pipe in the building shall have been submitted to a test of less than a 10 foot head of water or 5 pounds per square inch air pressure. Under this test, the water pressure shall remain constant for not less than 15 minutes without further addition of water.

2. *Air test.* The air test applied to the drainage system shall be made by attaching the air compressor test apparatus to any suitable opening and closing all other inlets and outlets to the system, then forcing air into the system until there is a uniform pressure sufficient to balance a column of mercury 10 inches in height or 5 pounds pressure per square inch on the entire system. This pressure shall be maintained for a period of not less than 15 minutes without further addition of air.

(h) *Building sewer test.* The buliding sewer and/or the private interceptor main sewer beginning at the public sewer main or private domestic sewage disposal system (septic tank) to the building drain shall be inspected before covering and tested before or after backfilling. The tests may be performed with water or air.

1. Water test. The water test shall be applied to the building sewer and/or private interceptor main sewer in its entirety or in sections. The entire sewer or sections of the sewer shall be tightly closed and filled with water. Each section to be tested or the entire sewer shall not be tested with less than a 7 foot head of water or 3 pounds per square inch pressure. Under this test, the acceptable tolerances of infiltration or exfiltration shall not exceed 8½ gallons per hour per inch of diameter, per mile.

2. Air test. The air test shall be applied to the bulding sewer and/or private interceptor main sewer in its entirety or in sections. The test shall be made by attaching the air compressor test apparatus to a suitable opening and closing all other openings, then forcing air into the sewer until there is a uniform presure of 3 pounds per square inch on the entire sewer. Under this test, the acceptable tolerance shall be equivalent to the exfiltration or infiltration of not more than 8½ gallons per hour, per inch of diameter, per mile.

(3) COVERING OF WORK. No part of any plumbing or drainage system shall be covered until it has been inspected, tested and approved. If any part is covered before being tested and approved, it shall be uncovered at the direction of the supervisor. See sub. (2) (b).

(4) FINAL INSPECTION. When the plumbing or drainage system is completed and fixtures are installed, the final inspection shall be made. See sub. (2) (b).

(5) INSPECTION FOR CHANGES OR ALTERATIONS. When additional fixtures are installed or the style or location of any fixture is changed or when changes are made in the piping system, the work shall be inspected and tested if deemed necessary by the plumbing supervisor.

(6) TESTS FOR REPAIRS. Inspections may be made, but tests shall not be required after replacing an old fixture, faucet or valve by a new one to be used for the same purpose. Such repairs or alterations may not be construed to include cases where new vertical or horizontal lines of soil, waste, vent, or interior rainwater conductors are used or their relative locations changed. In a building condemned by the proper authorities because of insanitary conditions of house drainage or plumbing, such repairs or alterations as are necessary to make the plumbing sanitary shall be made to conform to the provisions of this chapter. Tests and inspections of such alterations shall be made as for new buildings. No test or inspection shall be required where a house drainage and plumbing system or part thereof is set up for temporary exhibition purposes.

(7) DEFECTS IN MATERIALS. If tests or inspection discloses defective material leakage, or unworkmanlike construction, which does not conform to the requirements of this chapter, the same shall be removed and replaced and retested when necessary. The presence of any foreign substance about a joint or any part of a plumbing or drainage system shall be sufficient cause for condemning such joint or part of the system. Any split fittings, hubs or defective materials which do not conform to

the requirements of this chapter shall be removed and not used again. Poor workmanship, design or methods of installation likewise shall be sufficient cause for the condemnation of the whole or any part of the system.

History: Cr. Register, November, 1972, No. 203, eff. 12-1-72; renum. from H 62.23, Register, July, 1983, No. 331, eff. 8-1-83.

ILHR 82.24 Alternate and experimental materials. (1) **ACCEPTANCE OF ALTERNATE AND EXPERIMENTAL MATERIALS.** (a) The provisions of this chapter are not intended to prevent the use of any alternate material or method of construction provided any such alternate has been first approved and its use authorized by the department.

(b) The department may approve any such alternate provided the findings of the proposed design are satisfactory and comply with the intent of this chapter and the material offered is for the purpose intended, at least the equivalent of that prescribed in this chapter or that the methods of installation proposed conform to other acceptable nationally recognized plumbing standards.

(c) The department shall require that sufficient evidence or proof be submitted to substantiate any claims that may be made regarding the sufficiency of any proposed material or type of construction.

(d) Test shall be made in accordance with approved standards, but in the absence of such standards, the department shall specify the test procedure.

(e) The department may require tests to be made or repeated if, at any time, there is reason to believe that any material or device no longer conforms to the requirements on which its approval was based.

(2) **LISTING ALTERNATE AND EXPERIMENTAL MATERIALS.** (a) Standards listed or referred to in table 35 cover materials which will conform to the requirements of this section when used in accord with the limitations imposed in this table or other sections of this chapter.

1. Reduced pressure zone principle type backflow preventers, a. Use limitations Reduced pressure zone principle type backflow preventors may be used on cold water lines (maximum 110° F.) with a working pressure maximum of 150 pounds per square inch. The reduced pressure zone principle type backflow preventer may be installed with any plumbing fixture or equipment, the potable water supply outlet of which may be submerged and which cannot be protected by a vacuum breaker or a minimum air-gap. The use of a reduced pressure zone principle type backflow preventer does not eliminate requirements of this chapter for individual fixture devices such as vacuum breakers on flushometer valves, aspirators, sterilizers, etc., but not limited by enumeration.

b. Specifications. Reduced pressure zone principle type backflow preventers shall be manufactured to conform to the requirements of the American Water Works Association standard C506-69 and be approved by the department.

c. Installation. 1) Backflow preventers shall be installed above flood level. The location shall be accessible for testing, inspection and maintenance.

2) The reduced pressure zone principle type backflow preventer shall not be bypassed, made inoperative or removed without department approval. A complete history of each device shall be maintained by the owner to include a comprehensive listing from purchase to retirement, of all tests, inspections and repairs. The department reserves the right to require removal of the unit and replacement with an approved type installation if the unit does not provide full time protection against backflow or if inspections are not made regularly and reported to the department.

d. Approval. Approval shall be obtained from the department for each specific application prior to installation of the device. The request for approval shall be accompanied with detailed plans for the installation which must include the following information:

1) Location within building and elevation.

2) Piping diagrams detailing water supply inlet and detailed downstream piping diagrams indicating all fixtures, appliances, equipment, devices or appurtenances which the unit is serving. Anticipated flow rates are to be included on detailed plans along with manufacturer's name, model and size of reduced pressure zone principle type backflow preventer.

3) A copy of the annual inspection and maintenance agreement between owner and manufacturer's service representative or local plumbing inspector.

e. Testing. A reduced pressure zone principle type backflow preventer is a mechanical device that requires surveillance and periodic testing. An annual test shall be conducted in accordance with the following test procedure:

DIFFERENTIAL PRESSURE GAUGE TESTING METHOD FOR REDUCED PRESSURE BACKFLOW PREVENTER

Install test equipment as shown on following sketch.

Test No. 1.

Purpose: To test operation of pressure differential relief valve.

Requirement: The pressure differential relief valve must operate to maintain the zone between the two check valves at least 2 psi less than the supply pressure.

Steps:

- a. Close No. 2 gate valve tight.
- b. Install bypass hose from test cock #2 through a control valve to test cock #3.
- c. Open test cocks #2 and #3 and vent gauge.
- d. Open control valve on bypass hose slowly and note differential on gauge at initial opening of differential relief valve. Enter pressure differential in psi report.
- e. Close bypass control valve.

Test No. 2.

Purpose: To test No. 1 check valve for tightness against reverse flow.

Requirement: Valve must be tight against reverse flow under all pressure differentials.

Steps:

a. If the pressure differential relief valve is operating properly, and there is no drainage from it with the No. 2 gate valve closed tight, the No. 1 check valve shall be noted in the report as "closed tight". If there is drainage from the pressure relief valve, the check shall be noted as "leaked"

b. If the check valve is closed tight, the gauge will read approximately 6 psi minimum to 10 psi maximum. If the check valve leaks, the gauge will read the same as step d., test no. 1.

Test No. 3

Purpose: To test No. 2 check valve against reverse flow.

Requirement: Valve must be tight against reverse flow under all pressure differentials.

Steps:

a. Install a bypass hose from test cock #2 through a control valve to test cock #4.

b. Open test cock #4 and control valve. If water is discharged from the pressure differential relief valve, the #2 check valve shall be noted in the report as "leaked". If no water is discharged, the check valve shall be noted as "closed tight". Remove all test equipment and return gate valves to original setting.

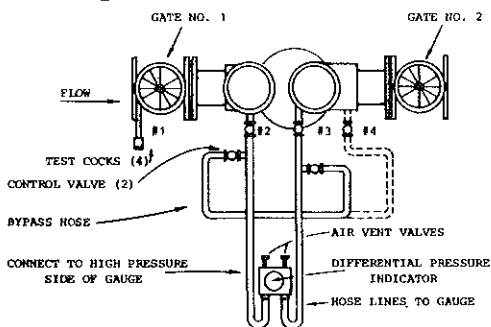

TESTING DIAGRAM

DIFFERENTIAL PRESSURE INDICATOR METHOD FOR REDUCED PRESSURE BACKFLOW PREVENTERS

If this test is not performed by the local plumbing inspector, it must be performed by the company from whom the device was purchased. The owner shall have an agreement with the manufacturer's service representative or local plumbing inspector. A copy of the agreement and test reports shall be submitted to the department's district office. The district office shall be notified 3 days in advance by the owner or manufacturer's service representative when tests are to be conducted or

scheduled repairs made. In addition to the annual test, the owner shall inspect the unit at least weekly for evidence of leakage through the relief valve port and submit monthly reports to the district office of the department. Defects found during inspection, testing or overhaul shall be corrected without delay.

2. Polyvinyl chloride (PVC) water distribution piping. a. Use limitations and specifications. Rigid PVC plastic pipe and fittings conforming to ASTM standard specification D 2241-69 and 2466-69 may be used for potable cold water distribution systems in single family residences and mobile homes. Plastic used in the cold water distribution piping shall be of schedule 40, and shall have a pressure rating of not less than 200 psi at 73.4° F. Plastic pipe, fittings, and solvent cement for rigid plastic pipe shall have received the seal of approval of the National Sanitation Foundation and all materials shall bear the stamped seal of approval. All plastic pipe and fittings shall be marked for identification purposes at intervals of not more than 5 feet and include the manufacturer's name or trademark, the ASTM designation, the SDR number, type of plastic nominal size and the NSF seal of approval.

b. Approval shall be obtained from the department for each specific building prior to installation of the material. The request for approval shall indicate the owner's name, type of building and street address. Installations not having prior approval by the department will be rejected.

3. Chlorinated Poly (vinyl chloride) (CPVC) plastic hot and cold water distribution piping. a. Use limitations and specifications. Rigid CPVC plastic pipe and fittings conforming to ASTM Standard specification D 2846-69T may be used for potable hot and cold water distribution piping systems in single family residences and mobile homes. CPVC plastic pipe and fittings shall not be used for hot water with temperatures exceeding 180° F. The CPVC plastic pipe and fittings used in the water distribution system shall have a pressure rating of not less than 200 psi at 73.4° Fahrenheit. Plastic pipe, fittings, and solvent cement for rigid plastic pipe shall have received the seal of approval of the National Sanitation Foundation and all materials shall bear the stamp, seal of approval. All plastic pipe and fittings shall be marked to include the manufacturer's name or trademark, NSF seal of approval, ASTM D 2846-70, material designation, pressure rating, nominal size, the SDR number, the code number identifying the compound and date of manufacture.

b. Approval shall be obtained from the department for each specific building prior to installation of the material. The request for approval shall indicate the owner's name, type of building and street address. Installations not having prior approval by the department will be rejected.

4. Acid or corrosive waste piping systems. A written approval by the department shall be obtained prior to installation. A request shall be in writing by the architect, engineer or owner with 3 copies of the system piping diagram (schematic or isometric). Contact the department for approved materials.

5. Polyvinyl chloride (PVC) sewer pipe and fittings. a. Use limitations and specifications. Polyvinyl chloride (PVC) sewer pipe and fittings

conforming to ASTM standards specifications D 3033-72 and D 3034-72 may be used for building sewer and private interceptor main sewer construction. The pipe shall be clearly marked at intervals of 5 feet or less with the manufacturer's name or trademark, nominal pipe size, the PVC cell classification (for example, 12454-B), the legend "type PSM PVC sewer pipe" (3034) or "type PSP SDR 41" (except 4 inch size shall be SDR 33.5 (3033) and the ASTM designation D 3033-72 or D 3034-72. Fittings shall be clearly marked with the manufacturer's name or trademark, nominal size, the material designation PVC, type PSM or PSP, and the ASTM designation.

b. PVC pipe and fittings shall be installed in accordance with ASTM recommended practices D 2321-72 and s. ILHR 82.04 (4) (f) 1. and (g).

c. Elastomeric gaskets for joint assembly shall meet all the requirements of ASTM C 443-70 and C 425-71 and be approved by the department.

d. The mixing of manufacturers' pipe or fittings is prohibited.

e. The building sewer and its relation to the water service pipe shall be installed in accord with s. ILHR 82.13.

6. No-Hub cast iron pipe and fittings. a. Use limitations. No-Hub cast iron pipe and fittings conforming to specifications set forth in table 35 may be installed in lieu of materials specified in s. ILHR 82.05 (2) for building drains serving one and 2 family dwelling structures.

7. PVC or ABS perforated plastic pipe and fittings. a. Use limitations. PVC or ABS perforated plastic pipe and fittings conforming to specifications set forth in table 35 may be installed in lieu of materials specified in ch. ILHR 83 for distribution piping for septic tank effluent soil absorption systems.

b. Identification. All pipe and fitting materials are to be identified as set forth in s. ILHR 82.19 (1) (b). Piping shall be marked at intervals of 5 feet or less and shall include the manufacturer's name or trademark, nominal size and the legent PVC or ABS sewer pipe.

c. Material specification. The PVC or ABS sewer pipe and fittings shall be manufactured in accord with the ASTM specifications indicated in table 35. The perforations in the plastic pipe shall be circular, $\frac{3}{8}$ inch plus or minus $\frac{1}{16}$ inch in diameter and arranged in 2 rows parallel to the axis of the pipe. The perforations shall be spaced approximately 3 inches center to center along the rows. These rows may be 90 to 125° apart.

d. Solvent cement. The solvent cements used shall comply with the appropriate ASTM specification for PVC or ABS piping material.

e. Installation. The PVC or ABS plastic pipe and fittings shall be installed and subjected to the same installation criteria as set forth in ch. ILHR 83.

8. Acrylonitrile-Butadiene-Styrene (ABS) composite sewer pipe and fittings.

a. Use limitations and specifications. ABS composite sewer pipe and fittings conforming to specificaton in table 35 may be used for building sewer and private interceptor main sewer construction. The pipe shall be

marked at intervals not exceeding 5 feet in letters not less than $\frac{5}{16}$ inch in height and of bold type style. The markings shall indicate the name of the manufacturer, ASTM designation D 2680-70, ABS and the nominal diameter. Couplings and fittings shall be marked to indicate the name of the manufacturer, ASTM designation D 2680-70 and nominal diameter.

b. Installation. ABS composite pipe and fittings shall be installed in accordance with ASTM specification D 2321-72. The mixing of other manufacturers' pipe and fittings is prohibited. Joints shall be made by solvent welding according to manufacturer's recommendations and ASTM specification D 2680-70.

(b) The department may issue supplemental bulletins for table 35 for materials, designs or methods of installation not included in this section.

(c) The department shall review all materials listed in this section on an annual basis to determine the acceptability of the material for inclusion in table 32, s. ILHR 82.19, rejection of its use or continue its use on experimental basis because of insufficient use.

Table 35

Materials	See Limitations to Subsection ILHR 82.24 (2), (a) Below	Standards and Specifications		
		ANSI	ASTM	Other
Reduced pressure zone principle type backflow preventers	1			AWWA C506-69
Polyvinyl chloride (PVC) (cold water distribution)	2		D2241-69 D2466-69	NSF 14
Polyvinyl chloride (PVC) (building sewer)	5		D3033-72 D3034-72	NSF 14
Chlorinated Poly (vinyl chloride) (CPVC) plastic (hot water dist. systems)	3		D2846-69T	Departmental approval required for each product or system
Acid or corrosive waste piping systems	4			
Polyethylene	4			
Polypropylene	4			
Proxylene	4			
Polyglass	4			
No-Hub cast iron (building drain)	6			
Acrylonitrile-butadiene-styrene (ABS) (perforated pipe)	7			Cast Iron Soil Pipe Institute 301-71
Acrylonitrile-butadiene-styrene (ABS) (composite sewer pipe and fittings)	8		D1788-68 D2751-71 D2235-67 D2680-GST	
Polyvinyl chloride (PVC) (perforated pipe)	7			

ILHR 82

Note: Copies of standards promulgated by the following technical societies referred to above are on file in the offices of the secretary of state, dept. of industry, labor and human relations and revisor of statutes and may be obtained for personal use from the following addresses:

American Water Works Association
2 Park Avenue, New York, New York 10016

American Society for Testing and Material
1916 Race St., Philadelphia, PA 19103

Cast Iron Soil Pipe Inst.
2029 K St. NW
Washington, D.C. 20006

National Sanitation Foundation
Testing Laboratory, Inc., P.O. Box 1468
Ann Arbor, Michigan 48106

History: Cr. Register, November, 1972, No. 203, eff. 12-1-72; renum. from H 62.24, Register, July, 1983, No. 331, eff. 8-1-83.

ILHR 82.25 Examination of plans and specifications. (1) **PLAN EXAMINATION REQUIRED.** Plans and specifications for plumbing to be installed in and/or outside of all buildings, structures, parks, areas or complexes in the following classifications shall be submitted to the department and written approval received before commencing work. The department shall immediately acknowledge receipt of all plans and specifications. The department may issue a permit to commence work provided plan review is not completed within 30 days. The issuance of a permit shall not be construed as plan approval or approval for non-code complying designs or installations. All non-code complying portions of the plumbing system installed prior to complete plan review under this permit shall be removed or replaced.

- (a) Health care and related facilities. See s. ILHR 82.15 (1) and (2).
- (b) Theaters and assembly halls.
- (c) Schools and other places of instruction.
- (d) Apartment buildings, hotels, motels, resorts and places of detention.
- (e) State of municipally owned buildings.
- (f) Reduced pressure zone principle type backflow preventers. See s. ILHR 82.24 (2) (a).
- (g) Controlled roof drainage systems. See s. ILHR 82.05 (4).
- (h) Factories, offices and mercantile buildings.
- (i) Mobile and manufactured homes.
- (j) Mobile home parks, water and sewerage systems. See s. ILHR 82.17 (1) (a).
- (k) Private interceptor main sewers. See s. ILHR 82.02 (90) (b).
- (l) Private domestic sewage treatment and disposal systems serving public buildings and experimental systems serving all buildings. See ch. ILHR 83.
- (m) Private water mains.

- (n) Water distribution systems.
- (o) Turf sprinklers.
- (p) Variances to code.

(2) **PLAN SUBMISSION.** (a) *Stamping and signing plans.* All plans and specifications shall be sealed or stamped in accord with ch. A-E 1 Wis. Adm. Code by a registered architect, engineer or registered plumbing designer. A master plumber may design and submit for approval plumbing plans and specifications for a plumbing system which he is to install. Each sheet of plans and specifications the master plumber submits shall be signed, dated and include his Wisconsin master plumber license number. Where more than one sheet is bound together into one volume, only the title sheet or index sheet need be signed and dated by the master plumber responsible for their preparation, provided the signed sheet clearly identifies all of the other sheet comprising the bound volume.

(b) *Submission data.* All plans, preliminary or complete, shall be submitted in duplicate with the exception of plans relating to private sewage disposal systems serving public buildings which shall be submitted in triplicate. Work shall not commence until written approval for the preliminary or complete plans is received from the department. The plans submitted shall be prints that are clear, legible and permanent. All pertinent data shall be a part of or shall accompany all plans submitted for review. Plans will be examined in the order of receipt.

(c) *Additions and alterations.* This section shall apply to additions and alterations exceeding 3 plumbing fixtures as well as to all new buildings and shall also apply to all cases where there is a change of the type of occupancy or use of a building which requires changes to or intended use of the plumbing so as to comply with this chapter for that occupancy or use.

(d) *Agent municipalities.* Examination of plans, specifications and calculations for the following type buildings and alterations to these buildings located in those municipalities shall be submitted to the municipality designated in (d) below for plan examination and approval according to requirements of ch. ILHR 82. Municipalities designated to perform plan examinations may set, by ordinance, plan examination fees. All other plans and specifications as listed in sub. (1) shall be submitted to the department for examinations.

1. Appleton.

- a. Theaters and assembly halls.
- b. Schools and other places of instruction except state-owned schools.
- c. Apartment buildings, hotels, motels, resorts and places of detention.
- d. Factories, offices and mercantile buildings.
- e. Private interceptor main sewers.

2. Dane county.

a. Private domestic sewage treatment and disposal systems serving public buildings.

3. Green Bay.

a. Theaters and assembly halls.

b. Schools and other places of instruction except state-owned schools.

c. Apartment buildings, hotels, motels, resorts and places of detention.

d. Factories, offices and mercantile buildings.

e. Private interceptor main sewers.

4. Madison

a. Theaters and assembly halls.

b. Schools and other places of instruction except state-owned schools.

c. Apartment buildings, hotels, motels, resorts and places of detention.

d. Factories, offices and mercantile buildings.

e. Private interceptor main sewers.

5. Manitowoc

a. Theaters and assembly halls.

b. Schools and other places of instruction except state-owned schools.

c. Apartment buildings, hotels, motels, resorts and places of detention.

d. Factories, offices and mercantile buildings.

e. Private interceptor main sewers.

6. Milwaukee

a. Theaters and assembly halls.

b. Schools and other places of instruction except state-owned schools.

c. Apartment buildings, hotels, motels, resorts and places of detention.

d. Factories, offices and mercantile buildings.

e. Private interceptor main sewers.

7. Muskego

a. Theaters and assembly halls.

b. Schools and other places of instruction except state-owned schools.

c. Apartment buildings, hotels, motels, resorts and places of detention.

d. Factories, offices and mercantile buildings.

e. Private interceptor main sewers.

8. Racine

- a. Theaters and assembly halls.
- b. Schools and other places of instruction except state-owned schools.
- c. Apartment buildings, hotels, motels, resorts and places of detention.
- d. Factories, offices and mercantile buildings.
- e. Private interceptor main sewers.

9. Sheboygan

- a. Theaters and assembly halls.
- b. Schools and other places of instruction except state-owned schools.
- c. Apartment buildings, hotels, motels, resorts and places of detention.
- d. Factories, offices and mercantile buildings.
- e. Private interceptor main sewers.

10. Two Rivers

- a. Theaters and assembly halls.
- b. Schools and other places of instruction except state-owned schools.
- c. Apartment buildings, hotels, motels, resorts and places of detention.
- d. Factories, offices and mercantile buildings.
- e. Private interceptor main sewers.

(3) **PLAN EXAMINATION FEES.** Fees shall be charged in accordance with s. Ind 69.23 (1), Wis. Adm. Code.

(4) **REVISIONS.** After written approval is granted, plans and specifications of plumbing systems shall not be changed without written consent of the department and the architect, engineer, designer or master plumber responsible for the design.

(5) **LIMITATIONS.** In granting approval of plans, specifications, products, devices or materials, the department does not hold itself liable for any defects in construction, nor for any damages that may result from the specific installation.

(6) **PLAN AVAILABILITY.** The architect, professional engineer, registered designer, owner or plumbing contractor shall keep at the construction site one set of plans bearing the stamp of approval of the department.

History: Cr. Register, October, 1974, No. 226, eff. 11-1-74; am. (2) (d), Register, April, 1976, No. 244, No. 5-1-76; cr. (1) (m) to (p), r. and recr. (3) (b) 2. to 8., cr. (3) (b) 9. to 14., Register, January, 1979, No. 277, eff. 2-1-79; r. and recr. (3), Register, June, 1982, No. 318, eff. 7-1-82; renum. from H 62.25, Register, June, 1983, No. 330, eff. 7-1-83.

