

Chapter H 62

DESIGN, CONSTRUCTION, INSTALLATION, SUPERVISION AND INSPECTION OF PLUMBING

H 62.01	Basic plumbing principles	H 62.14	Back-siphonage, cross-connections and potability control
H 62.02	Plumbing definitions	H 62.15	Health care and related facilities
H 62.03	Fixture unit design basis	H 62.16	Mobile homes
H 62.04	Building sewers	H 62.17	Mobile home parks
H 62.05	Building drains	H 62.18	Joints and connections
H 62.06	Stacks and branches	H 62.19	Materials
H 62.07	Vents	H 62.20	Private domestic sewage treatment and disposal systems
H 62.08	Fixture drain connections	H 62.21	Hangers and supports
H 62.09	Fixtures	H 62.22	Repairs and reconstruction
H 62.10	Traps and cleanouts	H 62.23	Inspection and tests
H 62.11	Interceptors, sumps, ejectors and special and industrial wastes	H 62.24	Alternate and experimental materials
H 62.12	Storm and clear water		
H 62.13	Water distribution systems		

H 62.01 Basic plumbing principles. (1) The basic principles of this code are enunciated as basic goals in environmental sanitation and safety worthy of accomplishment through properly designed, acceptably installed, and adequately maintained plumbing systems. Some of the details of plumbing construction must vary, but the basic sanitary and safety principles are the same. The results necessary to obtain the desired protection for the health of the people are the same everywhere. As unforeseen situations arise which are not specifically covered in the body of this code, the following principles shall serve to define the intent.

(2) Plumbing in all buildings, public and private, intended for human occupation or occupancy, shall at all times be installed in such manner so as to protect the health, safety and welfare of the public or occupants.

(3) Every building intended for human habitation or occupancy shall be provided with a supply of potable water; such supply shall not be cross connected with an unsafe water supply or with a waste pipe nor be subjected to any hazards of backflow or back-siphonage. When the premises abut on a street in which there is a public watermain, there shall be an individual connection to the public system.

(4) Buildings in which water closets and other plumbing fixtures, devices and appurtenances exist or are to be installed shall be provided with a supply of water adequate in volume and pressure by means of proper pipe sizing to insure that efficient use of the fixture is possible at all times.

(5) Devices for heating water and storing it in pressure vessels or tanks shall be so designed and installed as to prevent dangers of explosion or overheating.

(6) Every building intended for human habitation or occupancy on premises abutting on a street in which there is a public sewer shall have an individual connection with the public sewer.

(7) Each family dwelling unit provided with a drainage system shall have at least one water closet, one wash basin, one kitchen sink and one bathtub or shower to meet the basic requirements of sanitation and personal hygiene. All other structures for human occupancy or use shall be equipped with sufficient sanitary facilities as prescribed in this chapter or other applicable Wis. Adm. Code chapters and in no case no less than one water closet and one wash basin shall be provided.

(8) The entire building drainage system shall be so designed, constructed, and maintained as to conduct the waste water or sewage quickly from the fixture to the place of disposal, with velocities which will prevent clogging, fouling and the depositing of solids and shall have adequate cleanouts so arranged that the pipes may be readily cleaned.

(9) The drainage pipes should be so designed and constructed as to be proof for a reasonable life of the building against leakage of water or sewer drain air and offensive odors due to defective materials, imperfect connections, corrosion, settlements or vibrations of the ground or building, temperature changes, freezing or other causes.

(10) The drainage system shall be so designed that there will be an adequate circulation of air in all pipes, no danger of siphonage, aspiration or forcing of trap seals under conditions of ordinary use.

(11) All rooms in which water closets, urinals or similar fixtures are installed shall have adequate lighting and have proper ventilation to the outer air.

(12) Hot water shall be supplied to all plumbing fixtures which normally need or require hot water for their proper use and function.

(13) Plumbing fixtures shall be made of durable, smooth, non-absorbent and corrosion resistant material and shall be free from concealed fouling surfaces.

(14) If water closets or other plumbing fixtures exist in buildings where there is no sewer within a reasonable distance, suitable provision shall be made for disposing of the building sewage by some method of sewage treatment or disposal satisfactory to the department and local health authority having jurisdiction.

(15) Plumbing systems shall be maintained in a sanitary condition.

(16) Proper protection shall be provided to prevent contamination of food, water, sterile goods and similar materials by backflow of sewage.

(17) Plumbing shall be designed and adjusted to use the minimum quantity of water consistent with proper performance and cleaning.

(18) Fixtures, devices, appliances and appurtenances shall be supplied with water sufficient in volume and at pressures adequate to enable them to function satisfactorily and without undue noise under all normal conditions of use.

(19) All plumbing fixtures shall be so installed as to provide adequate spacing and shall be reasonably accessible for their intended use and for cleansing.

(20) Sewage or other wastes shall not discharge into water surface or sub-surface soil unless it has first been subjected to some acceptable form of treatment.

History: 1-2-56; r. and recr. Register, October, 1970, No. 178, eff. 11-1-70; r. and recr. (7), Register, November, 1972, No. 203, eff. 12-1-72.

Register, November, 1972, No. 203

H 62.015 History: Cr. Register October, 1970, No. 173, eff. 11-1-70; r. Register, November, 1972, No. 203, eff. 12-1-72.

H 62.02 Plumbing definitions. General. For the purpose of this code, the following terms shall have the meaning indicated in this section. No attempt is made to define ordinary words which are used in accordance with their established dictionary meaning except where it is necessary to define their meaning as used in this code to avoid misunderstanding.

Note: For definitions of master plumber, journeyman, restricted plumbers, apprentices and registered learners refer to Chapter 145 of the Wisconsin Statutes.

(1) **PLUMBING** in this code shall be defined as set forth in Wis. Stats. 145.01 (a), (b), (c), (d) and (e).

(2) **AIR-BREAK (DRAINAGE SYSTEM).** A piping arrangement in which a drain from a fixture, appliance, appurtenance or device discharges indirectly into another fixture, receptacle, or interceptor at a point below the flood level rim.

(3) **AIR-GAP (DRAINAGE SYSTEM).** The unobstructed vertical distance through free atmosphere between the terminus of the waste pipe and the flood level rim of the fixture, sight waste or other receptacle into which it discharges.

(4) **AIR-GAP (WATER SUPPLY SYSTEM).** The unobstructed vertical distance through the free atmosphere between the lowest opening from any pipe or faucet supplying water to a tank, vat, plumbing fixture or other device and the flood level rim of the receptacle.

(5) **ALIGNMENT.** Installed in a straight line, either horizontal, vertical or at a given angle.

(6) **APPLIANCES AND APPURTENANCES.** Includes any item or type of equipment not otherwise specifically defined, which is connected directly or indirectly with any portion of the plumbing system.

(7) **APPROVED.** Approved or accepted by the State Department of Health and Social Services, Division of Health.

(8) **AREA DRAIN.** A receptacle designed to collect surface or storm waters from an open area.

(9) **ASPIRATOR.** A fitting or device supplied with water or other fluid under positive pressure which passes through an integral orifice or "constriction" causing a vacuum.

(10) **AUTOPSY TABLE.** A fixture or table used for post-mortem examination.

(11) **BACKFLOW.** The reversal of flow of liquids in a piping system.

(12) **BACKFLOW PREVENTER (REDUCED PRESSURE ZONE TYPE).** An assembly of differential valves and check valves including an automatically opened spillage port to the atmosphere.

(13) **BACK-SIPHONAGE.** The formation of a negative pressure or vacuum which may occur in a water supply pipe causing the backflow of contaminated or polluted liquids to intermix with the potable water.

(14) **BACKWATER VALVE.** A device designed to prevent the reverse flow of storm water or sewage into the drainage system or branches thereof.

(15) **BASEMENT.** The lowest floor line elevation below grade which can be drained to the building sewer by gravity. All other stories below such elevation shall be considered sub-basement levels.

(16) **BATTERY OF FIXTURES.** Any group of 2 or more similar use adjacent fixtures installed so as to discharge into the same common horizontal soil or waste pipe.

(17) **BEDPAN STEAMER.** A fixture used for scalding bedpans or urinals by direct application of steam.

(18) **BEDPAN WASHER.** A fixture designed to wash bedpans and to flush the contents into the soil drainage system. It may also provide for sterilizing.

(19) **BEDPAN WASHER (HOSE).** A device supplied with hot and cold water and located adjacent to a receptacle for cleansing bedpans.

(20) **BELL (OR HUB).** That portion of a pipe which for a short distance is sufficiently enlarged to receive the end of another pipe of the same diameter for the purpose of making a joint.

(21) **BOILER BLOW-OFF BASIN.** A vessel designed to receive the discharge from a boiler blow-off outlet and to cool the discharge to a temperature which permits its safe entry into the drainage system.

(22) **BRANCH.** Any part of a piping system other than a main or stack.

(23) **BUILDING.** A structure having walls and a roof erected or set upon an individual foundation or slab-constructed base designed or used for the housing, shelter, enclosure or support of persons, animals or property of any kind. For purposes of this code, each structure abutting another structure which does not have an approved ingress-egress doorway through the basement foundation walls, or structures with separate exterior or exterior abutting walls, or public use structures separated by an unpierced firewall, shall be considered as a separate or individual building.

(24) **BUILDING (PRIVATE RESIDENCE).** A one family building or dwelling. See dwelling unit.

(25) **BUILDING (PUBLIC).** Means and includes any structure, including exterior parts of such building, such as a porch, exterior platform or steps providing means of ingress or egress, used in whole or in part as a place or resort, assemblage, lodging, trade, traffic, occupancy or use by the public, or by 3 or more tenants.

(26) **BUILDING DRAIN.** See sewers and drains.

(27) **BURR.** Roughness or metal protruding from the walls of a pipe usually as the result of cutting the pipe.

(28) **BY-PASS.** An installation of control valves and piping so installed as to temporarily isolate or by-pass a specific fixture, appliance, equipment or area of piping.

(29) **CATCH BASIN.** See interceptor.

(30) **CRESSPOOL.** A covered excavation in the ground which receives sewage or other organic wastes from a drainage system, and so designed as to retain the organic matter and solids, permitting the liquids to seep into the soil cavities. **PROHIBITED IN WISCONSIN.**

(31) **CISTERN.** A covered tank in which rainwater from roof drains is stored for household use or other purposes.

(32) **CLEANOUT.** A metallic plug or cover joined by means of a screw thread to an opening in a pipe, which can be removed for the purpose of cleaning or examining the interior of the pipe.

(33) **CLEAR WATER WASTES.** Cooling water and condensate drainage from refrigeration compressors and air-conditioning equipment, waste water drainage used for equipment chilling purposes, liquids having no impurities or where impurities have been reduced below a minimum concentration considered harmful and cooled condensate from steam heating systems or other equipment.

(34) **CODE.** These regulations, subsequent amendments thereto, or any emergency rule or regulation adopted governing the installation of plumbing, drainage and water supply or distribution system on private property.

(35) **COMBINATION FIXTURE.** A fixture combining one sink and laundry tray or a 2 or 3 compartment laundry tray in one unit.

(36) **CONDUCTORS.** The system of roof leaders, downspouts and pertinent piping located inside or outside of building, conveying storm or rainwater from the roofs of buildings or area to the storm drain, storm sewer, catch basin, rainwater cistern or ground surface.

(37) **CONTINUOUS WASTE.** A drain from two compartments of a single fixture connected to a single trap.

(38) **CROSS-CONNECTION.** Any physical connection or arrangement between two otherwise separate piping systems, one of which contains potable water and the other either water of unknown or questionable safety, or steam, gas or chemical, whereby there may be a flow from one system to the other, the direction of flow depending on the pressure differential between the two systems. See backflow and back-siphonage.

(39) **DEAD END.** That part of a drainage system which terminates upstream from the base of a vertical soil or waste stack or which is without a free circulation of air.

(40) **DEPARTMENT.** Department of Health and Social Services.

(41) **DEVELOPED LENGTH.** The length of a pipe line measured along the center line of the pipe and fittings.

(42) **DIP TUBE.** A pipe which conveys the cold water supply to the lower portion of an automatic water heater or water storage tank when the inlet opening is in the top portion of the tank.

(43) **DOMESTIC WASTES.** The water-carried wastes derived from ordinary living processes. See sewage.

(44) **DRAINAGE SYSTEM.** A drainage system includes the piping within public or private premises, which conveys sewage, rainwater or other liquid wastes to a legal point of disposal, but does not include the mains of a public sewerage system or private or public sewage treatment plant.

(45) **DURHAM SYSTEM.** A term used to describe soil or waste systems where all piping is threaded pipe, tubing or other such rigid

construction, using recessed drainage fittings, to correspond to the types of piping.

(46) **DWELLING UNIT.** One or more rooms with provisions for living, sanitary and sleeping facilities arranged for the use of one or more individuals of the same family

(47) **EJECTOR.** A device operated either electrically or by a mechanical means so constructed as to elevate liquid wastes and sewage from a lower level to a point of discharge into a public or private sewer or other final means of disposal.

(48) **FERRULE.** A metallic sleeve used to connect dissimilar plumbing materials.

(49) **FIRE PROTECTION SYSTEM.** A system of pipes and appurtenances used exclusively to supply water for extinguishing fires except the water service pipe as stipulated in sec. 145.01 (1) (c), Wis. Stats.

(50) **FIXTURE.** A receptable, appliance, device or equipment with or without a connection to the water supply system intended to receive or discharge water, liquids or water-carried wastes directly or indirectly into a drainage system.

(51) **FIXTURE UNIT.** A design factor so chosen that the load producing values can be expressed as multiples of that factor.

(52) **FIXTURE UNIT (DRAINAGE d.f.u.).** A measure of the probable discharge into the drainage system by various types of plumbing fixtures. The drainage fixture unit value for a particular fixture depends on its volume rate of discharge, on the duration of a single drainage operation and on the average time between successive operations.

(53) **FIXTURE UNIT (WATER SUPPLY s.f.u.).** A measure of the probable hydraulic demand on the water supply by various types of plumbing fixtures. The supply-unit value for a particular fixture depends on its volume rate of supply, the time duration of a single supply operation and the average time between successive operations.

(54) **FIXTURE UNIT FLOW RATE.** The total discharge flow in gallons per minute of a single fixture divided by 7.5 provides the flow rate of a particular fixture as a unit of flow. Fixtures are rated as multiples of this unit of flow.

(55) **FLOOD-LEVEL RIM.** The flood-level rim is the top edge of the receptacle from which water overflows.

(56) **GARAGE (PUBLIC).** A building or part of a building which accommodates or houses self-propelled land, air or water vehicles for 3 or more persons not of the same family.

(57) **GARAGE (PRIVATE).** A building used for the storage of vehicles or other purposes by a private family and which is not available for public use.

(58) **GRADIENT.** The fall or slope of a line of pipe in reference to a horizontal plane. In drainage systems it is usually expressed as the fall in a fraction of an inch per foot length of pipe.

(59) **HORIZONTAL PIPE.** Any pipe or fitting which makes an angle of less than 45 degrees to the horizontal.

(60) **HOT WATER.** Water at a temperature of 120° F. or more.

(61) **INDIRECT WASTE PIPE.** A waste pipe which does not connect directly to the drainage system, but conveys liquid wastes by discharging into the drainage system through an air-break, air-gap, into a trap, fixture, receptacle or interceptor.

(62) **INDUSTRIAL WASTES.** The liquid wastes resulting from the processes employed in industrial establishments which are free from fecal matter.

(63) **INTERCEPTOR.** A device designed and installed so as to retain deleterious, hazardous or undesirable matter from normal wastes while permitting normal sewage or liquid wastes to discharge into the drainage system by gravity.

(64) **GREASE BASIN (EXTERIOR).** A watertight tank installed underground for the collection and retention of grease from cooking or food processing and which is accessible for periodic removal of the contents.

(65) **GREASE INTERCEPTOR.** A manufactured receptacle designed to intercept and retain grease or fatty substances contained in kitchen and other food wastes.

(66) **GRIT & SAND INTERCEPTOR.** A receptacle designed to intercept and retain sand, grit, earth and other similar solids.

(67) **OIL INTERCEPTOR.** A unit designed to intercept and retain oil, lubricating grease or other like materials.

(68) **MANHOLE.** An opening constructed to a sewer or any portion of a plumbing system of sufficient size to permit a man to gain access thereto.

(69) **MAY.** May implies neither compulsion nor recommendation, only permission.

(70) **MOBILE HOME.** A mobile home is a transportable structure mounted on a chassis and designed to be used with or without a permanent foundation as a dwelling unit. The phrase "without a permanent foundation" indicates that the support system is constructed with the intent that the mobile home placed thereon will be moved from time to time at the convenience of the owner. See sections 218.12 and 348.07 (2), Wis. Stats.

(a) *Mobile home park sewerage system.* All structures and piping by which sewage is collected, conveyed and disposed of.

(b) *Mobile home building sewer.* That part of the plumbing system designed to serve one mobile home site from the mobile home drain connector to its connection with the mobile home park main or private disposal system.

(c) *Mobile home drain connector.* The terminal of all soil or waste piping of a mobile home to which the final waste connection is made to the building sewer.

(d) *Mobile home park water main.* That part of the water distribution system which extends from the street main or private supply to the mobile home water service.

(e) *Mobile home water service.* That part of the water service piping extended from the park water main, or private system, to one mobile home site.

(71) **NON-POTABLE WATER.** Water not safe for human consumption, hygiene or culinary use.

(72) **NUISANCE.** A "nuisance" under this section is referred to as any source of filth or probable cause of sickness pursuant to the provisions of sec. 146.14 of the Wis. Stats.

(73) **PIPE DIAMETERS.** When used in this code, shall mean the inside cross sectional dimension.

(74) **PLACE OF EMPLOYMENT.** Every place, whether indoors or out, or underground, and the premises appurtenant thereto, where either temporary or permanently any industry, trade or business is carried on, or where any process or operation, directly or indirectly related to any industry, trade or business is carried on and where any person is directly or indirectly employed by another for gain or profit, but shall not include any place where persons are employed in private or domestic service or agricultural pursuits which do not involve the use of mechanical power.

(75) **PLUMBING SYSTEM.** The plumbing system includes all water supply, water services and water distribution piping, plumbing fixtures and traps; soil, waste, and vent pipes; building drains, building sewers and private domestic sewage disposal systems including their respective connections, equipment, devices, appliances and appurtenances within the property line of the premises; and water-treating or water-using equipment in connection with the water and drainage systems and the installation thereof.

(76) **POTABLE WATER.** Potable water is water which is satisfactory for human consumption, hygiene and culinary use and meets the requirements of the state administrative authority having jurisdiction.

(77) **PRIVY.** A structure used by the public for the deposition of human body wastes.

(78) **PRIVY VAULT.** A watertight pit receptacle beneath a privy which receives human body wastes.

(79) **PROCESS PIPING.** Process piping is piping separated from the water distribution and/or drainage system by approved methods or means and used exclusively for refining, manufacturing, industrial or shipping purposes of every character and description.

(80) **RADIUS.** Radius is the distance from a center line or point to an axis of rotation.

(81) **RECEPTOR.** A fixture or device which receives the discharge from indirect wastes pipes.

(82) **REPAIRS & STOPPAGES.** Consists of making minor repairs to faucets, valves, pipes, appliances and removing of stoppages in building drains and sewers or waste pipes.

(83) **ROUGHING-IN.** The installation of all soil, waste, vent, water supply piping and supports pertinent thereto within a building to which fixtures, appliances and equipment are to be connected.

(84) **SAFING.** A pan or other collector placed beneath a pipe or fixture to prevent leakage from escaping to the floor, ceiling or walls.

(85) **SANITARY SEWER.** A sanitary sewer is a pipe which carries sewage and excludes storm, surface and ground waters.

(86) **SEWAGE.** The water carried wastes (organic) created in and

to be conducted away from residences, industrial establishments and public buildings. See domestic wastes.

(87) **SEWERAGE SYSTEM (PUBLIC)**. All structures, conduits and pipe lines by which sewage is collected and disposed of, except plumbing inside and in connection with buildings and properties served, and service pipes from building to street main. See Ch. 144, Wis. Stats.

(88) **SEWAGE SYSTEM (PRIVATE)**. (a) A system comprised of a septic tank and effluent absorption area designed for the purpose of processing sewage wherever public sewer facilities are not available.

1. **Annular space**. The area between the seepage pit chamber wall exterior and the unexcavated earth wall.

2. **Bedrock**. Any solid exposed rock or overlain by unconsolidated material.

3. **Detailed soil map**. A map prepared by a state or federal agency showing soil series, type and phases at a scale of not more than 2,000 feet to the inch.

4. **Distribution pipe**. A conduit of perforated clay tile, bituminous fiber, cement asbestos or short lengths of clay or concrete drain tile.

5. **Effluent**. Liquid flowing from a septic or treatment tank.

6. **Flood plain**. That portion of the land flooded by the highest known flood water elevation or that portion of the land that would be flooded by the regional flood elevation established by a state or federal agency.

7. **High ground water**. The upper limit of the portion of soil or underlying material that is saturated with water. (In some instances an upper or perched water table may be separated from a lower one by an impervious zone.)

8. **High water level**. The highest known flood water elevation of any lake, stream, pond or flowage or the regional flood elevation established by a state or federal agency.

9. **Holding tank**. An approved watertight receptacle for the retention of sewage.

10. **Legal description**. An accurate Metes and Bounds description or a lot and block number in a recorded subdivision or recorded assessor's plat or a public land survey description to the nearest 40 acres.

11. **Percolation test**. A method of testing absorption qualities of the soils.

12. **Reservoir**. A watertight receptacle basin or vault constructed above ground surface or underground for the storage of water intended for domestic use.

13. **Seepage pit**. An underground receptacle so constructed as to permit disposal of effluent or clear wastes by soil absorption through its walls.

14. **Seepage bed**. An excavated area similar to a seepage trench but larger than 3 feet in width and containing more than one distribution line.

15. **Seepage trench**. An area excavated 3 feet or less in width which contains a bedding of aggregate and a single distribution line.

16. **Septic tank**. A watertight tank which receives sewage.

17. **Soil boring**. A method of augering, boring or excavating through the ground surface to obtain samples of various stratum of earth to determine the characteristics and absorptive qualities of the soil, bedrock and ground water elevations.

18. Vent cap. An appurtenance of approved type used for covering the vent terminal of an effluent disposal system so as to avoid closure by mischief or debris and still permit circulation of air within the system.

(89) SEWERS & DRAINS. (a) *Sanitary*. 1. Building sewer. That part of the plumbing system beginning at the immediate outside foundation or proposed foundation wall to its connection with the main of a public sewer, private sewer, private sewage disposal system or other point of disposal.

2. Building drain. The lowest horizontal piping of a drainage system which receives the discharge of soil, waste and other drainage pipes inside any building and conveys same to the building sewer by gravity flow. See Wis. Adm. Code section H 62.08 (2) (c), sketch.

3. Building drain branch. That part of any drainage system which extends laterally at a slight grade, with or without horizontal change of direction from the building drain or subdrain. In this definition, horizontally means an angle less than 45 degrees with a horizontal plane and a rise not to exceed the inside diameter of the branch. See Wis. Adm. Code section H 62.08 (2) (c), sketch.

4. Building subdrain. The horizontal portion of a drainage system within a building which cannot flow by gravity to the building drain.

(b) *Storm*. 1. Building sewer. That part of the storm water system which receives the discharge from building storm drains and subdrains, parking lots, yard fountains and other permissive sources, and conveys such waters to a public storm water system, private storm water system or other approved point of disposal.

2. Building drain. The lowest horizontal piping which receives storm waters or other permissive water from roofs, area ways, court yards, canopies, enclosed parking ramps and other sources inside any building or structure and conveys same to the building storm sewer by gravity flow.

3. Building subdrain. Same as sanitary subdrain.

(90) SEWER. (a) *Private*. A privately owned building sewer serving a single building.

(b) *Private interceptor main sewer*. A privately owned building sewer not directly controlled by public authority. Privately owned means single ownership by an individual, firm or corporation, and approved by local authority and the department.

(91) SEWER (PUBLIC). A publicly owned sewer.

(92) SUBSOIL DRAIN. That part of a drainage system which conveys the ground or seepage water from the footings of walls or below the basement floor under buildings to the storm sewer or other point of disposal.

(93) SHALL. The word "shall" when used in this code is a mandatory requirement.

(94) SHOULD. "Should" is not mandatory but expresses the recommendation of the department.

(95) SIPHONAGE. A suction created by the flow of liquids in pipes.

(96) SLIP-JOINT. A connection in which one pipe slips into another, the joint of which is made tight with a compression type fitting.

(97) **SPECIAL WASTES.** Wastes which require special treatment before entry into the normal plumbing system.

(98) **SPECIAL WASTE PIPE.** Piping which conveys special wastes.

(99) **SPIGOT.** The end of a pipe which fits into a bell or hub.

(100) **STACKS & BRANCHES.** (a) *Stacks.* 1. Soil stack. Any pipe extending vertically which conveys the discharge of water closets, bed-pan washers or like fixtures with or without other fixtures to a horizontal branch, building drain or building subdrain.

2. Waste stack. Any pipe extending vertically which receives only liquid wastes free from fecal matter and conveys same to a horizontal branch, the building drain or building subdrain.

(b) *Branches.* 1. Branch. A horizontal drain pipe extending from a soil or waste stack to which vertical sections or extensions may be connected which receive the discharge from one or more fixture drains.

2. Branch interval. A distance along a soil or waste stack corresponding in general to a story height but in no case less than 8 feet within which the horizontal branches from one story of a building are connected to the stack.

(101) **STERILIZERS.** (a) *Boiling type.* A non-pressure type device used for boiling instruments, utensils, and/or other equipment for disinfection purposes.

(b) *Pressure instrument washer-sterilizer.* A pressure vessel fixture designed to both wash and sterilize instruments during the operating cycle of the unit.

(c) *Pressure (autoclave).* A pressure vessel designed to use steam under pressure for sterilizing. Also called an autoclave.

(d) *Water.* A device used for sterilizing water and storing sterile water.

(102) **STILL.** A device used in distilling liquids.

(103) **SUMP.** A tank or pit which receives sewage or liquid wastes located below the normal grade of the gravity system and which must be emptied by mechanical means.

(104) **SUMP PUMP.** A mechanical device other than an ejector for removing liquid waste from a sump.

(105) **SUPPORTS.** Supports, hangers, anchors and other devices for supporting and securing pipes, or fixtures to walls, ceilings, floors or structural members of a building.

(106) **SWIMMING POOL.** Any structure, basin chamber or tank containing an artificial body of water for swimming, diving or recreational bathing having a depth of 2 feet or more at any point.

(107) **TERMINAL.** That part of a drainage or vent piping system which projects above the roof of the building or at the end of the building effluent disposal system.

(108) **TRAP.** A fitting or device so designed and constructed as to provide, when properly vented, a liquid seal which will prevent the back passage of sewer air without materially affecting the flow of sewage or waste through it.

(a) *Trap crown.* Where the trap connects to or becomes a part of the horizontal arm of the trap which is integral with the trap.

(b) *Trap seal.* Trap seal is indicated by the height of the water column measured between the overflow and the dip separating the inlet and outlet arms of the trap.

(109) **TURF SPRINKLER UNIT.** A system of piping, appurtenances and devices so installed as to distribute water for lawn or other similar irrigation purposes without plumbing fixtures or means of use for human consumption.

(110) **VACUUM BREAKER.** An atmospheric device, pipe installed and designed to protect a water supply against back-siphonage by entry of air to relieve vacuums in the water distribution system. (A vacuum breaker is not designed to protect the water supply under conditions of backflow or back-pressures.)

(111) **VENT PIPE.** Any pipe provided to ventilate a plumbing system.

(a) *Back vent.* A pipe that connects to a soil or waste pipe to vent a single fixture trap and connects to the vent system above the fixture served with no part of it below the fixture trap.

(b) *Branch vent.* That part of the vent piping which extends horizontally with or without lateral or vertical extensions and to which other vent pipes connect.

(c) *Circuit vent.* A vent pipe which serves 2 or more fixture traps which discharge to a nearly horizontal soil or waste branch and extends from the downstream side of the furthestmost upstream fixture trap to the main soil or waste vent or main vent so that a circuit is formed.

(d) *Continuous vent.* A vertical vent pipe that is a continuation of the vertical waste pipe to which it connects.

(e) *Loop vent.* Similar to a back vent except that part of it extends below the trap it serves before reconnecting to the vent piping system.

(f) *Main soil or waste vent.* That part of the stack above the highest installed fixture opening or branch connection. (Commonly referred to as a stack vent.)

(g) *Main vent.* A vent pipe connected to the base of a soil or waste stack below the lowest fixture branch extending vertically with or without change of direction and which serves as a terminal for other vent pipe connections and terminates through the roof or connects with the main soil or waste pipe at a point 2 feet or more above the highest soil or waste opening, but in no case less than 38 inches above the highest floor on which soil or waste openings are installed.

(h) *Relief vent.* The vent pipe connected to a soil or waste pipe close to the stack in a manner to equalize minus and plus pressures in the stack.

(i) *Stack venting.* A method of venting a fixture or group of fixtures through the soil or waste stack.

(j) *Sterilizer vent.* A separate pipe or stack connected indirectly to the building drainage system at the lowest terminal, which receives the vapors from non-pressure sterilizers or the exhaust vapors from pressure sterilizers and conducts the vapors directly to the outer air. (Commonly referred to as vapor, steam, atmospheric or exhaust vent.)

(k) *Unit vent.* One which denotes an installation so arranged that one pipe will serve traps from two identical fixtures at the same point when connected to a vertical soil or waste pipe.

(l) *Wet vent.* That portion of a vent pipe which receives the discharge from wastes other than water closets, kitchen fixtures or other sources containing like sewage or fecal matter.

(m) *Yoke vent.* A pipe connecting upward from a soil or waste stack into a main vent pipe in a manner to equalize pressures within the stacks.

(112) **WATER SOFTENER.** An appliance, appurtenance or device used for the purpose of ion exchange or demineralizing water.

(113) **WATER SUPPLY (PRIVATE).** Private water supply means one or more sources of ground water, including facilities for conveyance thereof, such as wells, springs and pumps, on one property, other than those serving a municipality or a group of 10 or more premises of mixed ownership.

(114) **WATER SERVICE.** A pipe extended from the water main or private pumping system or other supply source with or without lateral extensions to the building, structure or other system to be served.

(115) **WATER DISTRIBUTION SYSTEM.** Those pipes which convey water from the service pipe to the plumbing fixtures, appliances, appurtenances, equipment, devices or other systems which are to be served.

(116) **WIPED JOINT.** The fusion of metal with solder, smoothly finished with a wiping cloth and having a thickness of at least one-fourth inch at the point where the pipes are joined.

(117) **WORKMANSHIP.** Work of such character that will fully secure the results sought in all the sections of this code as intended for the safety, welfare and health protection of all individuals.

(118) **YARD DRAIN.** The horizontal piping and its branches which convey the surface drainage from areas, courts or yards outside the walls of a building to the storm water sewer.

(119) **MISCELLANEOUS. Standards or Specifications Abbreviations.**

A.G.A. -----	American Gas Association, Inc. 420 Lexington Ave., New York, New York 10017
A.N.S.I. -----	American National Standards Institute, Inc. 1430 Broadway, New York, New York 10018
A.S.M.E. -----	American Society of Mechanical Engineers 29 W. 39th St., New York, New York 10018
A.S.S.E. -----	American Society of Sanitary Engineering 960 Illuminating Building, Cleveland, Ohio 44113
A.S.T.M. -----	American Society for Testing and Material 1916 Race St., Philadelphia, Pa. 19103
A.W.W.A. -----	American Water Works Association 2 Park Avenue, New York, New York 10016
C.S. -----	Commercial Standards, Supt. of Documents Government Printing Office, Washington, D. C. 20401
F.S. -----	Federal Specifications General Services Administration, Regional Office 3, Washington, D. C. 20407

- M.S.S. -----Manufacturers Standardization Society
of the Valve and Fittings Industry
420 Lexington Ave., New York, New York 10017
- N.S.F. -----National Sanitation Foundation
Testing Laboratory, Inc., P. O. Box 1468,
Ann Arbor, Michigan 48106
- U.L. -----Underwriters' Laboratories, Inc.
207 E. Ohio Street, Chicago, Illinois 60611
- W.C.F. -----Water Conditioning Foundation
1201 Waukegan Road, Glenview, Illinois 60025

History: 1-2-56; am. (8), (42) (b) and (c); (46) and (49), Register, February, 1957, No. 14, eff. 3-1-57; r. and recr. Register, October, 1970, No. 178, eff. 11-1-70; cr. (119), Register, October, 1971, No. 190, eff. 11-1-71; r. and recr. (70); (79) through (118) are renum. to be (80) through (119); (119) is renum. to be (79); am. (89) (a) 2. and 3. as renum., r. and recr. (90) as renum. Register, November, 1972, No. 203, eff. 12-1-72.

H 62.03 Fixture unit design basis. (1) INTERMITTENT FLOW FIXTURES. The fixture unit value and the size of traps, vents, and piping shall be as designated in the following table for any fixture named therein. For fixtures not included in the following table, contact the department for the fixture value rating. Equivalent value for other intermittent operating fixtures shall be one fixture unit for each 7.5 gallons per minute of flow rate.

Table 1

Type of Fixture	Unit Value	Trap Minimum Size Inches	Soil or Waste Minimum Size Inches	Vent Minimum Size Inches
Automatic clothes washers, Commercial (individual).....	4	2	2	1½
Commercial (large capacity)*.....				
Residential.....	3	1½	1½	1½
Bathtubs, all types**.....	3	1½	1½	1½
Bed pan washer.....	6	2	3	2
Bidet.....	2	1½	1½	1½
Cuspidor, fountain or dental.....	1	1¼	1¼	1¼
†Dishwasher (commercial)***.....	4	1½	1½	1½
†Dishwasher (residential).....	1	1½	1½	1½
Drinking fountain.....	1	1¼	1¼	1¼
Drinking fountain (refrigerated).....	½			
Floor drain, 2 inch.....	3	2	2	1½
3 inch or larger****.....	4	3	3	2
Laundry tray.....	3	1½	1½	1½
†Refrigerated cases.....	1	1½	1½	1½
Shower stall, each head.....	4	2	2	1½
Sinks, Cup.....	1	1¼	1¼	1¼
Factory wash-up.....	4	1½	1½	1½
Fountain or bar.....	3	1½	1½	1½
Food waste disposers (commercial).....	2 HP or less	1¼ or 2	2	1½
Food waste disposers (commercial).....	3 HP or more	3	3	2
Laboratory.....	2	1½	1½	1½
Laboratory, school.....	2	1½	1½	1½
Classroom juvenile.....	2	1¼	1¼	1¼
Pack or plaster.....	4	2	2	1½
Residential (with or without F. W. G.).....	4	1½	1½	1½
Restaurant, Scullery, pots and pans.....	4	2	2	1½
Food, rinsing, cleaning or thawing.....	3	1½	1½	1½
Service sink, flushing rim.....	6	3	3	2
Service sink, wall outlet.....	4	2	2	1½
Service sink, wall outlet.....	4	3	3	2
Service sink, floor outlet.....	4	2	2	1½
Service sink, floor outlet.....	4	3	3	2
Shampoo sink, barber or beauty parlor.....	2	1¼ or 1½	1½	1½
Surgeons, wash-up.....	3	1½	1½	1½
Sterilizer, Bed pan.....	4	2	2	1½
Garbage can washers.....	3	3	3	2
†Instrument or water.....	1	1¼	1¼	1¼
Urinal, Men.....	4	2	2	1½
Women.....	6	2½	3	2
†Vegetable display cases.....	2	1½	1½	1½
Wash basin.....	1	1¼	1½	1¼
Water closet, tank type.....	6	2	3	2
Water closet, flush valve.....	8	2	3	2

*Based on discharge rate (See section H 62.03 (2).)

**Includes foot, Sitz and infant baths and regular bathtubs with or without showers.

***Based on discharge rates and number of outlets, 4" trap and waste pipe minimum recommended.

****Trap and waste pipe sizes to correspond to floor drains.

†Requires air-gap discharge.

(2) CONTINUOUS FLOW FIXTURES. Fixtures such as pumps and ejectors from which there is continuous or semi-continuous discharge shall

have a fixture unit value of one for each one gallon per minute of flow.

(3) **UNIT CAPACITY AND LENGTH OF SANITARY PIPING.** The number of fixture units connected to any stack, branch or vent and the length of piping shall not exceed that shown in the following table for a given diameter of pipe. After maximum length of vent for any given pipe size is reached, the diameter of the pipe shall be increased to the next size.

Table 2
Fixture Unit Capacity and Maximum Water Closets
or Like Fixtures on Soil, Waste or Vent Pipe

Pipe Diameter (Inches)	Soil or Waste				Vent	
	Fix. Units on Vertical Pipe	Water Closets or Like Fixtures on Vertical Pipe	Fix. Units on Horizontal Pipe	Water Closets or Like Fixtures on Horizontal Pipe	Fix. Units on Vent (See limi- tations)	Maximum Length Vent (in feet)
1½	1		1		1	50
1¾	8		4		12	65
2	18		9		24*	85
2½	40		20		60*	105
3	50	2	25*	1	126**	212
4	252	33	126	17	252	300
5	680	80	340	40	680	390
6	1,380	120	690	60	1,380	610
8	3,600	225	1,800	112	3,600	750
10	7,600	400	3,800	200	7,600	---
12	12,000	575	6,000	288	12,000	---

*Limitation of one 6 or 8 fixture unit fixture.

**Limitation of six 6 or 8 fixture unit fixtures.

Table 3
Gravity Condensation Drains Total Number of Connections

Drain Outlet Size	Indirect Main Waste Size							Assigned Fixture Unit Value
	¾	1	1¼	1½	2	2½	3	
½	2	4	6	9	16	25	36	0-¼
¾	1	1	3	4	7	11	16	0-½
1	0	1	1	2	4	6	9	0-¾
1¼	0	0	1	1	2	4	6	1
1½	0	0	0	1	2	3	4	2
2	0	0	0	0	1	1	2	5
2½	0	0	0	0	0	1	1	9
3	0	0	0	0	0	0	1	14

History: 1-2-56; r. and recr. Register, October, 1970, No. 178, eff. 11-1-70; am. (1), Register, October, 1971, No. 190, eff. 11-1-71.

H 62.04 Building sewers. (1) **PREMISES SERVED.** The interior plumbing of each building shall be entirely separate from and independent of that of any other building. All sanitary, storm drainage or special type drainage system shall be connected, by means of independent connections, with a public sewer, approved private interceptor main sewer or private sewage disposal system.

Note: See section H 62.20 (1) (b).

(2) **MATERIALS.** All building sewers shall be constructed of cast iron, vitrified clay, concrete, asbestos cement, plastic or bituminous fiber pipe or other materials approved by the department. See Wis.

Register, November, 1972, No. 203

Adm. Code sections H 62.19 and H 62.24. Corrugated steel pipe may be used for building storm sewer. See limitations, Wis. Adm. Code section H 62.19.

(3) **SIZE.** (a) *Sanitary sewer.* The size of the building sewer shall be determined by the total number of drainage fixture units tributary thereto. The diameter of the building sewer shall be equal to or greater than the size of the building drain. The minimum size of the building sewer from the mains in the street to the property line shall be 4 inches inside diameter. The minimum size of the building sewer beginning at the property line to the building shall be 3 inches inside diameter. The following table shall apply to sanitary building sewers and building drains.

Table 4

Diameter of Pipe (inches)	Maximum Number of Fixture Units		
	$\frac{1}{8}$ " per ft. slope	$\frac{1}{4}$ " per ft. slope	$\frac{1}{2}$ " per ft. slope
2	4	9*	12*
3	24**	30**	42**
4	115	150	210
5	270	370	540
6	510	720	1,050
8	1,290	1,860	2,640
10	2,520	3,600	5,250
12	4,390	6,300	9,300

*Building drain only; 6 or 8 unit fixtures prohibited.

**Limitation of one 6 or 8 fixture unit fixture.

(b) *Storm sewer.* The required size of building storm sewers, other exterior drains and lateral branches is to be determined on the horizontal projection of roofs, yards and other tributary areas to be drained according to table 11, 11a and 11b. See Wis. Adm. Code section H 62.12 (3) (c). The building storm sewer shall be of a size to accommodate, under normal flow rate capacities, the entire volume of wastes tributary to same. The minimum size of the building storm sewer from the terminal in the street to the property line shall be 4 inches inside diameter. No building storm sewer shall be less than 3 inches inside diameter, inside the property line, or smaller than the building storm drain to which it connects except a decrease in size will be permitted if the increase in slope is sufficient to maintain the volume of flow. Such reduction in size shall be made in a manhole.

(4) **INSTALLATION.** (a) *Gradient.* Building sewers shall, where possible, have a slope of one-fourth inch per foot. In no case shall there be less than one-eighth inch per foot unless a minimum velocity of 2 feet per second is attained throughout the sewer by gravity flow. Between the lot line and the sewer main, or riser pipe therefrom, the sewer shall be laid at a uniform slope not exceeding one-half inch per foot. Building sewers 12 inches or larger in diameter may be installed with a grade equal to main interceptors of the same diameter. Where the main sewer in the street has sufficient depth, or where a lot is 3 feet or more above the established grade line, the building sewer between the lot line and the building shall not exceed

a gradient of one-half inch per foot except for a change in elevation which shall be made by the use of 45 degree fittings.

(b) *Depth.* Sanitary building sewers shall be installed at a depth of not less than 42 inches below finished grade unless authorized by the department. Building sewers installed shallower than 60 inches below finished grade shall be provided with frost protection as required by local ordinance for which the method of frost protection has received approval by the department. Building sewers which terminate in a septic tank shall not be less than 18 inches from top of pipe to finished grade.

NOTE: See appendix A for frostproofing recommendations.

(c) *Riser—main sewer.* A riser from the main sewer may be installed to establish the elevation for the building sewer to insure the proper gradient and depth in accord with section H 62.04 (4) (a) and (b).

(d) *Alignment.* All building sewers shall be laid in alignment between fittings. Any changes in grade or direction shall be made with approved "Y's" or long radius fittings. Clipping of pipe or fittings is prohibited.

(e) *Trenching.* All excavations shall be open trench work unless otherwise permitted by local ordinance or accepted by the local inspector.

Note: See sections Ind 6.06, 6.12 and 6.21 concerning timber requirements for trenches and general safety precautions.

(f) *Stable bottom.* Where the bottom of the trench can be maintained in a stable condition and free of water during time of installation of pipe, the building sewer, depending on the type of material used, shall be bedded and be initially backfilled as hereinafter provided. Grade, as used in this subsection, is defined as the elevation of the bottom of the pipe.

1. Concrete, clay, bituminous fiber, plastic and asbestos-cement pipe. The trench bottom throughout its length shall be excavated to a depth at least 3 inches below the grade elevation except where sand is encountered and shall be brought back to grade with pea gravel, washed stone or crushed stone bedding. The size of the bedding material shall be such that 100% shall pass a $\frac{3}{4}$ inch sieve and 90% retained on a No. 8 U. S. Standard sieve. The bedding shall be shaped to accommodate pipe bells or couplings. Initial backfill on the sides of the pipe and to a depth of 12 inches over the pipe shall be well tamped sand, gravel, crushed stone or excavated material which is neither corrosive nor organic in nature. The material shall be of such size that 100% shall pass a one-inch sieve. Initial backfill shall be placed in increments not exceeding 6 inches in depth and be well tamped for the full length of the sewer.

2. Cast iron soil pipe. Where the trench bottom does not contain stone larger than one inch in size or where bedrock is not encountered, the trench may be excavated to grade. When stone larger than one inch in size or when bedrock is encountered, the trench shall be excavated to a depth at least three inches below the grade elevation and be brought back to grade with a bedding of sand, gravel, or crushed stone of which 100% shall pass a one-half inch sieve. The bedding material shall be tamped in place. The bedding or trench bottom shall be shaped to accommodate the bells of the pipe. Initial

backfill on the sides of the pipe and to a depth of 3 inches over the pipe for that part of the building sewer laid on private property shall be well tamped sand, gravel, crushed stone or excavated material which is neither corrosive nor organic in nature. The material shall be such that 100% shall pass a one-inch sieve. For that portion of the sewer in the street, the initial backfill material to a depth of 12 inches over the pipe shall be sand, gravel or crushed stone of such size that 100% shall pass a one-inch sieve. It shall be placed in increments not exceeding 6 inches and be well tamped.

(g) *Unstable bottom.* Where a mucky or unstable bottom is encountered in the trench, the required dry and stable foundation conditions shall be provided by sheathing driven and left in place to a depth of 48 inches below the trench bottom or to solid foundation at a lesser depth, the removal of wet and yielding material to a depth of 24 inches or to solid material, and replacement of the unstable material with limestone screenings, pea gravel or equivalent material for the bedding under the pipe. The trench bedding shall be shaped to accommodate pipe bells or couplings. In lieu of the foregoing, the required dry and stable foundation conditions may be provided by installation of a longitudinally reinforced concrete cradle the width of the trench and at least 3 inches thick or by installation of a longitudinally reinforced concrete slab the width of the trench at least 3 inches thick and bedding material as provided for in section H 62.04 (4) (f) 1 and 2. Initial backfill material and its placement shall conform to that specified in section H 62.04 (4) (f) 1 and 2. All sheathing shall be cut off at a depth of 3 feet or more below the ground surface to prevent heaving due to frost action.

(h) *Access.* When building sewers exceed 100 feet in length cleanouts of the same diameter shall be not more than 75 feet apart on piping up to and including 4 inches in diameter; not more than 100 feet apart on piping 5 to 10 inches in diameter. Manholes shall be constructed for main interceptor sewers 12 inches and larger at intervals not to exceed 200 feet, or at each change of direction of more than 45 degrees. All cleanout openings shall extend to finished grade.

(i) *Industrial waste control.* All building sewers serving manufacturing or industrial processing plants or service stations (gas and oil) which are connected to a public sewer system shall have installed therein a manhole for periodic sewage sampling purposes. The manhole shall be of approved design and shall be located on public right-of-way where possible. When manholes are installed on private property they shall be readily accessible at all times.

1. *Location.* Sampling manholes should be located on public property whenever possible. When located on private property they shall be within 5 feet of the lot line fronting on the public right-of-way and authorized representatives shall be guaranteed the right of access.

2. *Construction.* Sampling manholes shall be a minimum of 36 inches in diameter and constructed in a watertight and substantial manner and may be of concrete, precast concrete, cast iron, bituminous fiber, enamel coated 14 gauge steel, or vitrified clay pipe. Construction details shall follow the general criteria as shown in the following sketch:

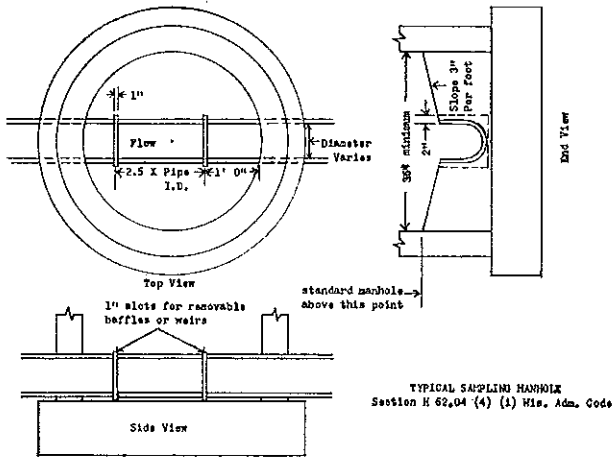

(j) *Backfill completion.* Due care shall be exercised in placing the balance of the backfill to prevent breakage of the pipe. Large boulders or rock or concrete slabs, or frozen masses shall not be used in the backfill nor shall machinery be operated within the trench until a cover of 6 feet over the pipe has been attained.

(5) **INSPECTION.** The building sewer and/or private interceptor main sewer shall be inspected upon completion of placement of the pipe and before backfilling and tested before or after backfilling. A "T" or "Y" may be provided to permit testing the pipe for leakage or infiltration. Such "T" or "Y" shall be located as near as possible to the point of connection with the street or main sewer. See Wis. Adm. Code section H 62.23.

(6) **CONNECTIONS TO MAIN SEWER.** When a building connection on the street or main sewer is not found within 3 feet of the point designated by the local governing body, or its authorized representative, a "Y" or "T" fitting approved by the department shall be used. The connection shall be set upon or in a carefully cut opening centered in the upper quadrant of the street sewer, and be secured by encasement of the main sewer pipe and the fitting with concrete at least 3 inches thick so as to assure permanency of connection and adequate backing of the street sewer pipe. In lieu of the use of fittings and in the event that the opening cannot be centered in the upper quadrant of the street sewer, a length of the street sewer pipe shall be removed and a "Y" branch section inserted in its place. The joints at the ends of such section shall be encased in concrete at least 3 inches thick. Such connection or insertion shall be made under the supervision of the authorized representative of the municipality.

(7) **SEWER OPENINGS PROTECTED.** The ends of all sewer pipes not immediately connected shall be securely closed so as to prevent the introduction of sand or earth or drainage from an excavation.

(8) **LIMITATIONS AND PROHIBITIONS.** (a) *Location.* The following minimum distances shall be maintained between building sewers and water wells.

1. Sanitary and storm sewers, including sanitary and storm build-

ing drains, of cast iron pipe with leaded or neoprene gasket joints—8 feet.

2. Sanitary and storm sewers, including sanitary and storm building drains, other than cast iron—25 feet.

(b) *Use of building sewers.* No person shall connect to a public sewer any building drain or sewer through which is discharged any substance likely to cause undue corrosion, obstruction, nuisance, explosion or interference with sewage treatment processes. See Wis. Adm. Code section H 62.11.

(c) *Storm and clear water connections.* Roof conductors, surface drains, groundwater drains, foundation footing, refrigerator cooling water, storm water drains, drinking fountains, air-conditioning and other clear water drains not described herein shall whenever possible discharge to storm drains or sewers, but they shall not be discharged to a sanitary building drain or sewer or to a private sewage disposal system. Building storm sewers shall not be connected to a building sanitary sewer. The building sanitary sewer and building storm sewer shall be installed as 2 separate pipe lines and shall connect to the appropriate street or main sewer. See Wis. Adm. Code section H 62.12 (1) (b).

History: 1-2-56; am. (10) (b), Register, February, 1957, No. 14, eff. 3-1-57; am. Register, August, 1961, No. 68, eff. 9-1-61; r. and recr. Register, October, 1970, No. 178, eff. 11-1-70; am. (4) (i) 2., Register, October 1971, No. 190, eff. 11-1-71; am. (1), (2), (3) (a), (b), (4) (b), (f) 1, (5), (8) (b), (c), Register, November, 1972, No. 203, eff. 12-1-72.

H 62.05 Building drains. (1) **ELEVATION.** All building drains shall be brought into the building underground. Building drains shall be installed below the level of the basement floor providing the public sewer, septic tank or private sanitary interceptor main elevation permits. See following sketch.

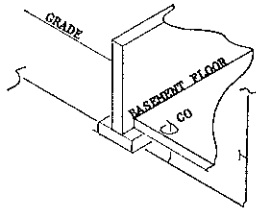

(2) **MATERIALS.** All building drains shall be constructed of concrete, vitrified clay, type L hard temper copper, plastic, cast iron pipe or other materials approved by the department. See Wis. Adm. Code sections H 62.19 and H 62.24. The use of concrete, plastic or vitrified clay pipe is permitted only where there is a soil covering of 18 inches or more or where the pipe is covered with 9 inches of soil and a substantial concrete floor having a minimum 3 inch thickness. Where a building drain leaves the building at a point above the basement floor, it shall be constructed of cast iron or type L hard temper copper pipe to a point 5 feet from the inside of the building foundation wall or to such additional distance as necessary to reach undisturbed stable ground.

(3) **SIZE.** (a) *Sanitary.* The size of building drains and building sub-drains shall be determined by the number of fixture units tributary thereto. The minimum size of a building drain and building

sub-drain shall be 2 inches inside diameter. The maximum length of the 2 inch underground building drain shall not exceed 20 feet. See Wis. Adm. Code sections H 62.03 (3) table 2, H 62.04 (3) (a) and H 62.08 (7) (a).

(b) *Storm.* The building storm drain size shall be determined on the total area to be drained thereby and other wastes tributary to the drain. The minimum size of the roof leaders shall be determined from table 5 or shall be calculated using the formula following the table. The size of the building storm drain shall be not less than that specified in tables 11, 11a and 11b. See Wis. Adm. Code section H 62.12 (3) (c).

Table 5

Type of Roof	Allowable Roof Area in Square Feet for Given Size of Inside Leader					
	2½"	3"	4"	5"	6"	8"
Roof covered with gravel, slag or similar material with incline ¼" to 1' or less.....	Up to 1,645	1,646 to 2,120	2,121 to 3,780	3,781 to 5,885	5,886 to 8,490	8,491 to 15,125
Same with incline ½" to 1' or more and sawtoothed roofs.....	Up to 1,220	1,221 to 1,770	1,771 to 3,150	3,151 to 4,905	4,906 to 7,075	7,076 to 12,600
Metal, tile, brick, slate, or similar roofs of any incline.....	Up to 975	976 to 1,415	1,416 to 2,520	2,521 to 3,925	3,926 to 5,660	5,661 to 10,080

(c) *Barrett's formula.* For vertical leaders serving roofs covered with gravel or slag, with an incline not exceeding one-quarter of an inch per foot, allow 300 square feet of roof surface to each square inch of leader opening; for roofs of greater incline or sawtooth roof construction, 250 square feet roof surface to each square inch of leader opening; for metal, tile, slate, or similar roofs of any incline, 200 square feet of roof surface to each square inch of leader opening. This formula using the 300 square feet of area for each square inch of leader opening can also be used for determining the size required for draining yards and other areas. To determine the diameter of the vertical leader required, the following formula can be used:

$$\text{vertical leader diameter} = 1.128 \sqrt{\frac{\text{roof area}}{300 \text{ or } 250 \text{ or } 200}}$$

(4) CONTROLLED ROOF DRAINAGE. (a) *Approval.* Storm water roof drainage systems employing or incorporating special types of equipment, devices, weirs or other methods of controlling or delaying flow volume velocities or capacities for the purpose of minimizing pipe diameter requirements shall receive department approval before installation.

(b) *Design.* The system shall be designed using the area rainfall rate criteria, the formulae applicable to the specific manufacturers roof drain equipment to be installed, other pertinent design data and applicable state plumbing code rules.

(c) *Plans.* Blueprints (isometric or schematic) shall be prepared in triplicate for submission to the department for review. The plans shall contain the entire system layout including the building storm drain and storm sewer. All criteria and data pertinent to the proposed installation shall be included with the plans including other clear water waste tributary thereto. The installation shall not be revised or deviate from the approved plan without prior authorization from the department.

(5) **BACKFLOW VALVES.** Building drains subject to backflow or backwater at the time of installation shall be provided with adequate backwater valves, installed to prevent interference with the flow and be readily accessible for cleaning.

(6) **OTHER REQUIREMENTS.** Installation of building drains shall also conform to Wis. Adm. Code section H 62.04 (4) (a) as to gradient, section H 62.04 (4) (f) and (g), (7) and (8); sections H 62.18, H 62.19 and H 62.24, insofar as they are applicable and necessary for proper installation.

History: 1-2-56; am. (1), (2) and (3), Register, February, 1957, No. 14, eff. 3-1-57; am. Register, August, 1961, No. 68, eff. 9-1-61; r. and recr. Register, October, 1970, No. 178, eff. 11-1-70; am. (3) (a), Register, October, 1971, No. 190, eff. 11-1-71; am. (1), (2), (3) (a), (b) and (6), Register, November, 1972, No. 203, eff. 12-1-72.

H 62.06 Stacks and branches. (1) **GENERAL.** (a) *Soil or waste stacks required.* Every building in which plumbing is installed shall have at least 1 vertical stack which shall run as directly as possible from the building drain through the roof.

1. Commercial and industrial type buildings. The furthestmost soil or waste stack connected to the building drain shall extend undiminished in size from the stack cleanout fitting to the roof terminal. Where a building is served by more than 1 building drain connecting to separate building sewers, a minimum 3 inch stack shall be installed to serve each building drain.

2. Residential type buildings. The furthestmost soil stack connected to the building drain shall extend undiminished in size from the stack cleanout fitting to the roof terminal. Where a building is served by more than 1 building drain connecting to separate building sewers, a minimum 3 inch stack shall be installed to serve each building drain.

(b) *Size of soil and waste stacks.* All soil and waste stacks shall be sized according to Table 2 except as follows: No soil stack shall be less than 3 inches in diameter from the highest soil fixture connection to the stack cleanout fitting. When a building contains but one stack, its minimum size shall be 3 inches in diameter.

(c) *Stack offsets.* An offset in a vertical soil or waste pipe with a change of direction of 45 degrees or less from the vertical may be sized as a straight vertical stack.

(d) *Stack base connections.* A long sweep $\frac{1}{4}$ bend, two $\frac{1}{8}$ bends, or a wye and $\frac{1}{2}$ or $1/6$ bend or its equivalent shall be used at the base of all vertical soil and waste stacks.

(e) *Soil and waste pipe extensions.* Any pipe extending from a soil or waste pipe shall be carried full size required to serve the fixture connections and shall be vented or reverted to conform with the provisions of section H 62.03 (1) and (3).

(f) *Soil and waste pipe protected.* No soil or waste pipe shall be installed or permitted outside a building, or concealed in outside walls

or in any place where they may be subjected to freezing temperatures unless provision is made to protect them from frost.

(g) *Roof terminals.* Each soil, waste or vent stack shall be increased to at least 4 inches inside diameter or terminate with a department approved frostproof flashing. When the vent is increased to 4 inches inside diameter, the increase shall be made at least 4 inches below the roof and shall extend at least 8 inches to 12 inches above the roof at this point. When the extension is greater than 12 inches or the roof is used for other purposes than weather protection, such extension shall extend not less than 5 feet above the roof. All roof terminals extending more than 12 inches above the roof shall be protected from frost closure.

Note: When the department filed its amendments of rules on October 2, 1972 the filing stated that section H 62.06 (1) (g) was "amended to read". Apparently there was no intention to delete the old paragraph (1) (g) 1. and it is being printed here:

1. *Location.* The roof terminal if within 8 feet of any door, roof louver, attic vent, window, scuttle or air shaft shall extend at least 2 feet above same. Vent pipes shall not terminate under the overhang of the building. All roof terminals shall be located a minimum of 20 feet from any air intake unit or device.

(2) **HORIZONTAL SOIL AND WASTE PIPE.** (a) *Size and gradient.* All horizontal soil and waste piping shall be sized in accordance with table 2, except that no horizontal waste pipe carrying the discharge of fixtures shall be less than 1¼ inches in diameter. The minimum gradient shall be ¼ inch per foot wherever possible; in no case shall the grade be less than ⅛ inch per foot.

(b) *Change in direction.* All changes in direction shall be made by the proper use of 45 degree wyes, long sweep ¼ bends, 1/6, ⅓ or 1/16 bends, or with fittings producing a like radius, except that single or double sanitary tees may be used on a vertical stack. Short ¼ bends may be used in soil and waste piping where the change in direction of flow is from the horizontal to the vertical and for closet discharge connections.

(c) *Increases and reducers.* Where different sizes of pipes, fittings or combinations thereof are to be connected, proper size increasers or reducers shall be used.

(d) *Fittings.* Fittings in the drainage system shall conform to the type of piping used. Fittings on screwed, threaded or other approved pipe shall be of recessed drainage pattern. All special fittings used in the soil, waste or vent lines shall be submitted to the department for acceptance.

(3) **HANGERS AND SUPPORTS.** Vertical piping shall be substantially supported at 10 foot intervals or floor levels. Provisions shall be made for expansion and contraction of piping and for structural settlement that may affect the piping. Horizontal piping shall be supported at intervals not to exceed 10 feet. Cast iron soil pipe shall be supported at intervals of not more than 5 feet. Supports secured in or against masonry shall be attached with expansion bolts or other approved methods without the use of wood plugs. All piping shall be rigidly secured and supported so that proper alignment will be retained. See Wis. Adm. Code section H 62.21 (3) (a).

(4) **MATERIALS.** All main or branch soil and waste pipes within the building which will be installed aboveground shall be of cast iron, galvanized steel, galvanized wrought iron, lead, brass, DWV, "M", "L" or "K" type copper, borosilicate glass, plastic or other

materials which are deemed acceptable to the department for alternate or experimental purposes. Materials installed underground shall be of lead, brass, type "L" or "K" copper, borosilicate glass, cast iron, concrete, vitrified clay, plastic or other materials approved by the department for experimental purposes. All pipe materials other than cast iron, concrete, plastic or vitrified clay pipe, when

installed so as to be embedded in or through concrete, shall be adequately protected by thoroughly applying 2 coats of asphaltum paint or tar paper wrapping or other equivalent means of insulation. For borosilicate glass installed underground, trenching shall be continuous for that portion of the piping which will be below the floor slab. The bottom of the trench shall be constructed so that the pipe will have solid bearing along its entire length. If rock is encountered, the trench shall be undercut 6 inches and backfilled with sand. All buried glass piping shall be covered with polystyrene casing material. All fittings, connections, and joints shall have equally adequate protection. Backfill to a point 12 inches over the pipe shall be earth or sand void of rock, concrete slabs, or frozen masses. No galvanized steel or wrought iron soil or waste pipe shall be laid underground. Underground piping shall also conform to Wis. Adm. Code section H 62.04 (4) (a) as to gradient, H 62.04 (4) (f) and (g), (7) and (8), sections H 62.18, H 62.19 and H 62.24, insofar as they are applicable and necessary for proper installation. DWV type copper pipe shall not be installed for horizontal piping serving urinals, water closets, bedpan washers, bedpan sterilizers or like fixtures.

(5) FUTURE CONNECTIONS. All openings in soil or waste pipes provided for future fixture connections shall be properly connected, vented and sealed. See section H 62.03 (1) and (3).

History: 1-2-56; am. (2) Register, February, 1957, No. 14, eff. 3-1-57; r. and recr. Register, October, 1971, No. 190, eff. 11-1-71; am. (1), (g), (2) (a), (3) and (4), Register, November, 1972, No. 203, eff. 12-1-72.

H 62.07 Vents. (1) BACK VENTS. A back vent or continuous vent pipe shall be provided to serve each trap except as otherwise specified in this chapter.

(2) CIRCUIT VENTS. A circuit vent may serve a horizontal soil or waste pipe to which 2 and not more than 8 like fixtures are to be connected. See following sketch. For proper fixture connections, see applicable code sections.

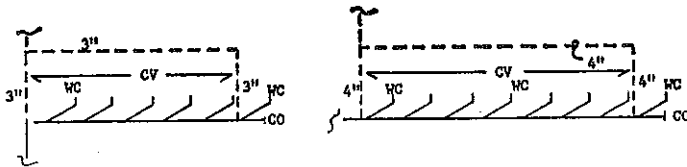

CV = CIRCUIT VENT

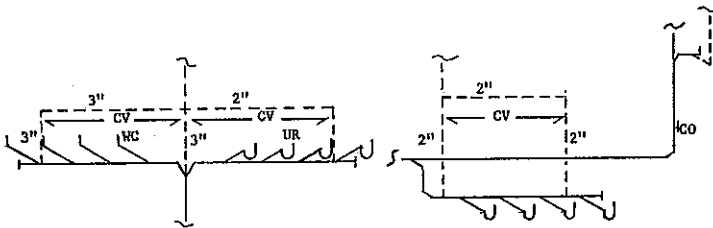

(a) *Size.* The size of the circuit vent shall be determined by the total number of fixture units connected thereto. This subsection shall

not apply to floor outlet water closets or bedpan washers or fixtures intended for such uses.

(3) CROWN VENT. In no case shall a vent be connected to the crown of a trap.

(4) LOOP VENT. A single island type or isolated fixture may be served by a loop vent when no other method of venting is possible. See following sketch.

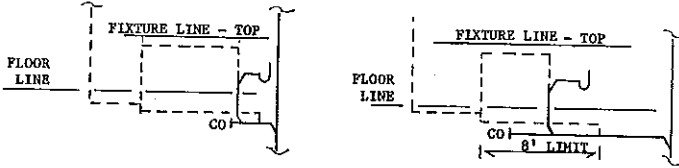

(5) MAIN SOIL OR WASTE VENT. Every building having plumbing fixtures or a plumbing system shall have installed therein at least 1 main soil or waste vent (stack vent) of at least 3 inch inside diameter which shall extend from a soil or waste stack at least 3 inches in diameter to the roof terminal.

(6) MAIN VENT. All vertical soil or waste pipes 3 inches or larger in diameter serving fixtures on 3 or more floor levels shall be provided with a main vent pipe. The size of the main vent shall be determined by the number of fixture units to be served and shall extend full size from the base connection to the point of terminus. See following sketch. See section H 62.03 (1) and (2).

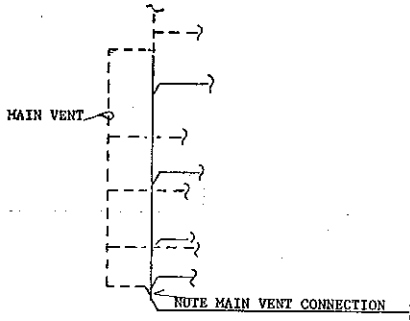

(7) RELIEF VENTS. Where fixtures discharge above a soil or waste pipe served by a circuit vent, each soil or waste pipe shall be provided with a relief vent in the form of a wet or dry vent, taken off ahead of the first fixture, with a diameter of not less than 1½ inches or one-half the diameter of the horizontal soil or waste pipe to which it is connected or whichever is greater. See following sketch.

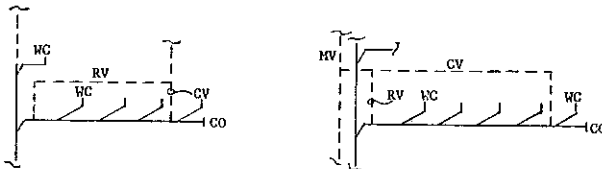

(8) **SUDS VENTS.** Buildings of 3 stories or more having a separate waste stack to serve clothes washers, dishwashers with or without kitchen sinks shall be provided with a suds vent. See following sketch.

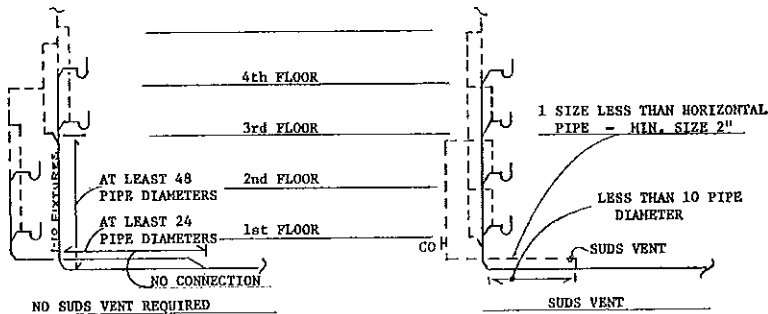

(9) **UNDERGROUND VENT.** Any vent pipe installed underground shall have a minimum inside diameter of 2 inches.

(10) **UNIT VENT.** Two identical fixtures located on the same floor level discharging through the same approved drainage pattern fitting into a vertical soil or waste pipe may be served by a unit vent pipe as hereafter indicated. (Also referred to as a common vent.)

(11) **WET VENT.** Fixtures with a unit value of only one or less may be used to wet vent floor outlet fixtures located on the same floor level as the fixture creating the wet vent.

(12) **YOKE VENT.** All soil and waste pipes served by a main vent in buildings 8 floors or 80 feet or more in height shall be provided with a yoke vent at each 40 foot interval. The size of the yoke vent shall be not less than the size of the smaller pipe to which it connects. The lower end of each such vent shall connect to the soil or waste pipe through a wye below the horizontal branch serving the floor and the upper end shall connect to the main vent pipe through an inverted wye or a tee fitting not less than 3 feet above the floor level. Compute height locations from building drain upward.

(13) **VENT RELOCATION.** Where fixtures are afterwards installed on a soil or waste pipe above existing vent connections to the main soil or waste vent, the vent piping system shall be rearranged to conform to the provisions of this chapter.

(14) **VENT PIPE GRADES AND CONNECTIONS.** All vent pipes shall be free from drops or sags and shall be so graded and connected as to drain back to the soil or waste pipe by gravity. Whenever it becomes necessary to trap a horizontal vent pipe, it shall be drained back into a waste pipe by gravity.

(15) **VENT CONNECTIONS.** All vent pipes shall be run separately through the roof, be connected to other vent pipes or vent stacks a minimum of 4 inches below the roof, or be reconnected to the main vent pipe not less than 38 inches above the highest floor on which fixtures are installed. All changes in direction from vertical to horizontal on any vent shall be made above the overflow rim of the fixture, but not less than 36 inches above the floor wherever possible. No fitting or fittings for future waste connections shall be placed in any soil or waste pipe above the point of revent connection.

(16) **SPECIAL VENTS.** (a) *Blow-off tanks.* Vents serving blow-off tanks or basins shall not be connected to the vent pipe system serving the sanitary drainage system.

(b) *High temperature steam vents.* Vent pipes serving steam operated sterilizers, cleansing or degreasing equipment, pressing machines or any other apparatus which normally discharges steam into a vent shall be connected to a vent which is separate from the plumbing system.

(c) *Chemical piping.* Vent piping serving waste piping systems conveying acids, caustics, chemical or other similar wastes shall be connected to piping materials approved for such use and shall not reconnect to the plumbing vent piping system, but shall extend separately to the atmosphere.

(17) **ALTERNATE VENTING SYSTEMS.** Design of venting arrangements other than set forth in this chapter shall be submitted to the department for approval prior to installation.

(18) **MATERIALS.** Vent piping materials to be installed aboveground shall be of cast iron, galvanized steel, galvanized wrought iron, lead, brass, plastic, or DWV, "K", "M", or "L" type copper, borosilicate glass or other materials approved by the department. See sections H 62.19 and H 62.24, Wis. Adm. Code. Materials installed underground shall be of cast iron, type "K" or "L" copper, borosilicate glass, brass, galvanized wrought iron, plastic, or lead. See Wis. Adm. Code sections H 62.19 and H 62.24. All pipe materials other than cast iron pipe, when installed so as to be embedded in or through concrete, or other corrosive materials shall be adequately protected by thoroughly applying 2 coats of asphaltum paint or tar paper wrapping, or other equivalent means of insulation. For borosilicate glass installed underground, trenching shall be continuous for that portion of the piping which will be below the floor slab. The bottom of the trench shall be constructed so that the pipe will have solid bearing along its entire length. If rock is encountered, the trench shall be undercut 6 inches and backfilled with sand. All buried glass piping shall be covered with polystyrene casing material. All fittings, connections, and joints shall have equally adequate protection. Backfill to a point 12 inches over the pipe shall be earth or sand void of rock, concrete slabs, or frozen masses.

History: 1-2-56; am. (7) (b), Register, February, 1957, No. 14, eff. 3-1-57; r. and recr. Register, October, 1971, No. 190, eff. 11-1-71; am. (18), Register, November, 1972, No. 203, eff. 12-1-72.

H 62.08 Fixture drain connections. (1) **GENERAL.** (a) *Installation.* All plumbing fixtures shall be installed in a manner to afford easy access for cleaning. Enclosures under or around fixtures shall be provided with a circulation of air. Where possible, all piping from fixtures shall be installed within partitions or walls. Access panels shall be provided wherever faucets, valves or traps are concealed. Backgrounds or fixture carrier supports shall be provided for off the floor type fixtures and for other special conditions.

(b) *Drain connections.* Each fixture shall be provided with a water sealed trap installed as near to the fixture as possible. In no case shall the horizontal distance between the trap outlet opening and vent exceed 24 times the inside diameter of the soil or waste pipe serving an aboveground fixture. The total grade of the soil or waste

pipe shall not exceed the inside diameter of the pipe. Horizontal waste arms should be avoided wherever possible. See following sketch.

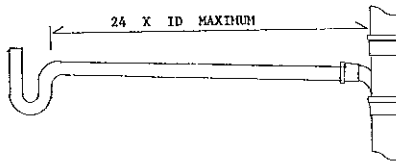

(c) *Vertical distance.* The vertical distance of any waste connection between the top of the fixture strainer or opening to the center line of the horizontal waste pipe shall be as close as possible but shall not exceed 15 inches, except floor drains shall not exceed 24 inches. Floor outlet water closets may have a distance of 36 inches between the water level of the fixture and the center line of the horizontal soil pipe serving same.

(d) *Horizontal distance.* The horizontal distance of any waste connection for a fixture served by a separate trap shall not exceed 12 inches measured from the vertical center line of the trap inlet to the center line of the fixture waste outlet. See following sketch.

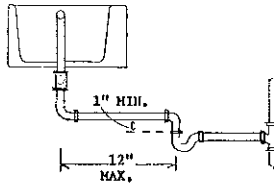

(e) *Stacking fittings.* Fixtures shall not be connected to soil or waste pipes through stacking of fittings unless each fixture trap is served by an individual back vent.

(2) **BACK VENTS, NOT REQUIRED.** (a) *Unit vent.* Floor outlet fixtures such as water closets, bedpan washers, bedpan sterilizers, service sinks and like use fixtures, not to exceed 2, located on the same floor level which discharge within point of vent limitations into a vertically installed combination vented double wye and $\frac{1}{8}$ bend or sanitary tee-cross with no other fixtures discharging into the same pipe above them need not be individually back vented.

(b) *Other fixtures.* Two identical fixtures located on the same floor level discharging through the same approved drainage pattern fitting may be connected to a vertical waste pipe except that double tapped tees and sanitary crosses shall not be used in any food waste disposer connection.

(c) *Basement and sub-basement fixtures.* Floor outlet water closets, shower receptors, floor drains, service sinks, elevator catch basins or swimming pool sump drains, not to exceed 2 or combination of any 2, connected to an underground building drain or subdrain need not be back vented when the developed distance of the horizontal soil or waste pipe does not exceed 48 times the inside diameter of the pipe. The minimum vent size serving the building drain or subdrain with unvented fixtures connected thereto shall be at least 2 inches inside

diameter. Where a vertical soil or waste pipe 3 inches or larger in diameter is involved, the branch connection shall be located 8 feet or more in the direction of flow from the base of such pipe. One fixture shall be the maximum permitted on any unvented horizontal branch. The minimum size branch shall be 3 inches inside diameter. See following sketch.

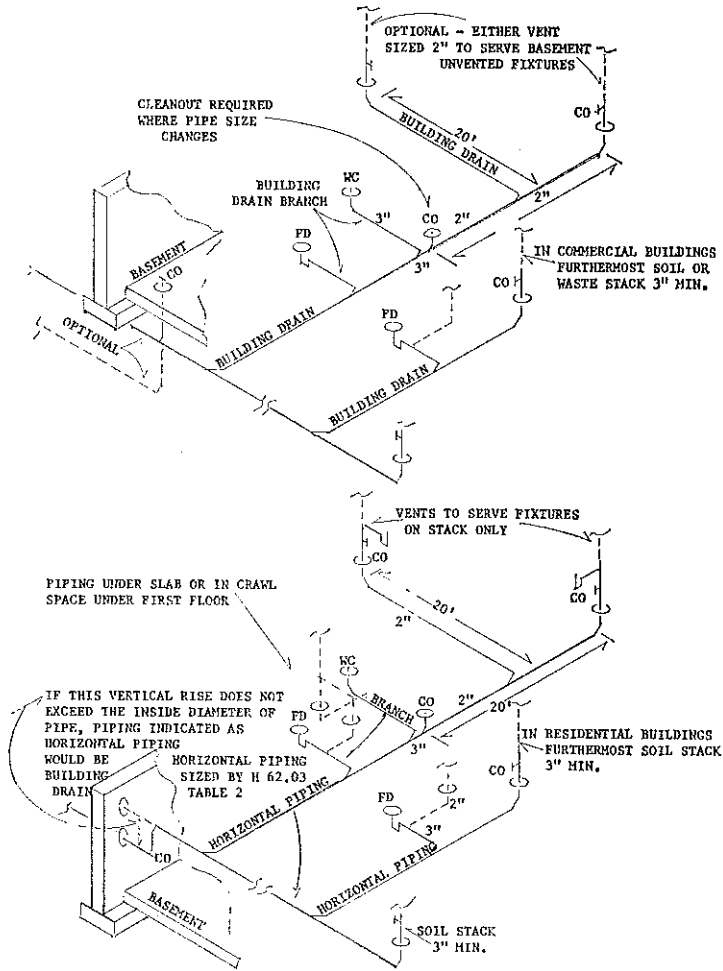

(d) *Kitchen sinks.* Residential kitchen sink fixtures with or without food waste disposal units, not to exceed 3 in number, located directly above one another on individual floors, may connect to a 3 inch diameter vertical waste pipe and need not be individually back vented. Back to back installations are prohibited under this section unless each combination is individually vented. See following sketch.

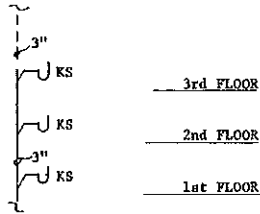

(e) *Other waste connections.* Where separate trapped waste connections from a vented line to each compartment are not installed to serve two-compartment sinks, directional type continuous waste fittings shall be installed. Directional fittings used with a single trap to receive the combined discharge from both sink compartments shall meet all requirements pertaining to venting on the waste discharge side of the trap.

(3) **BAR WASTES.** Bar and soda fountain sinks shall have individual traps and shall connect into a waste pipe which may discharge into an open fixture or receptor through an air-break or air-gap. The total length of the horizontal waste pipe shall not exceed 30 feet. Piping materials may be cast iron, type "L" or "K" copper, galvanized steel, galvanized wrought iron, borosilicate glass, plastic or other materials approved by the department. See following sketch.

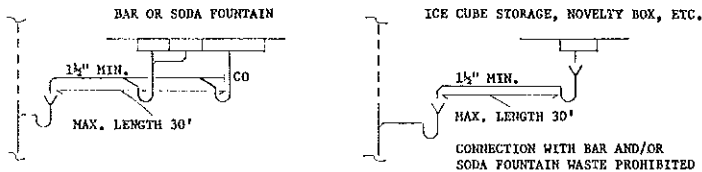

(4) **CLOTHES WASHERS.** (a) *Residential.* Automatic clothes washers shall discharge indirectly into the drainage system through an air-break type connection. Where a standpipe is used for the point of discharge, the length of the standpipe shall be not less than 20 inches measured from the top of the trap inlet to the top of the standpipe. The top of the pipe shall terminate 2 inches below the flood level of the washer drum.

(b) *Commercial.* Large tumble action or drum type clothes washing equipment should discharge into a floor type receptor through an air-break or by other approved methods having a drain adequate in size to rapidly dispose of the waste water. The size of the drain shall be determined by the manufacturers discharge flow rate and section H 62.03 (2). Interceptor drains shall have a wire basket or other device, removable for cleaning, that will prevent passage into the drainage system of solids $\frac{1}{2}$ inch or larger in size, string, rags, buttons or other materials detrimental to the sewerage system. Laundries having wastes containing oils, sand or other solids shall in addition to the above requirements provide an acceptable means of interception for this material.

(5) **DISHWASHING MACHINES.** (a) *Residential.* Residential dishwashing machines shall not be directly connected to any waste piping, but shall discharge its waste through a fixed air-gap installed above

the machine. The drain connection from the air-gap may connect to an individual trap or to a directional fitting installed in the sink tailpiece. For gravity drain dishwasher, see sketch A.

1. The drain from a dishwashing machine shall not be connected to a food waste disposal unit, sink tailpiece or continuous waste on the discharge side of a food waste disposal unit. Two traps shall be used when a sink, food waste disposal, and dishwashing machine are installed. See following sketches.

(b) *Commercial.* Commercial dishwashing machines shall not be directly connected to any waste piping system, but shall discharge its waste separately through a fixed air-gap into an individual trap which is properly vented.

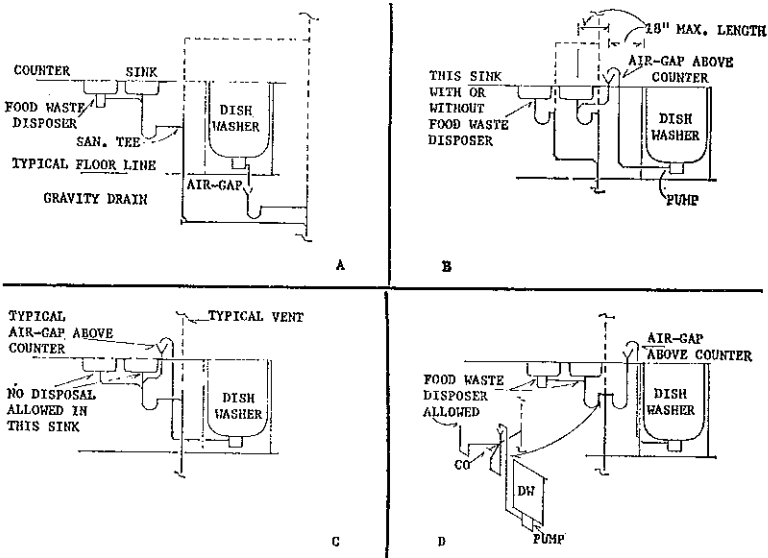

(6) **DRINKING FOUNTAINS.** Refrigerated water coolers may connect to the sanitary piping system.

(7) **FLOOR DRAINS AND BACKWATER VALVES.** (a) *Underground.* All floor drains connecting directly to an underground building drain or building subdrain shall be of cast iron with a water seal of not less than 2 inches and shall have a waterway of not less than 3 inches inside diameter. The unit shall be so constructed, installed and located with the drain inlet in view at all times and so as to provide easy access for cleaning purposes. When such drains are subject to backflow, they shall be equipped with an approved backwater valve.

(b) *Above ground locations.* Floor drains located above ground may have a 2 inch minimum water seal and inside diameter waterway. The maximum length of an unvented horizontal waste pipe shall be no greater than 24 times its inside diameter.

(8) **FOOD WASTE DISPOSERS.** (a) *Household disposers.* The minimum size trap, waste pipe and vent to serve a single food waste disposer shall be 1½ inches inside diameter.

(b) *Commercial disposers.* Installations shall comply with the requirements of section H 62.03 (1). For 3 HP or greater capacity or special type units, the manufacturer shall specify the maximum discharge rate of the unit. The size of available waste or building drain and water supply shall be adequate to serve the unit.

(c) *Fittings.* Tapped tees and sanitary crosses shall not be used in any new food waste disposer connection to the waste piping system. Connection of horizontal waste piping serving waste disposer units to vertical piping less than 4 inches in diameter shall be made by the use of a sanitary tee. See following sketch.

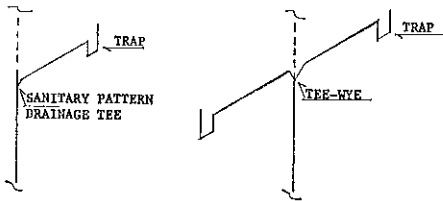

(d) *Prohibited disposer use.* No glass, metal, crockery, stone, gravel, concrete, shellfish shells, plastic, fibrous or other indigestible material shall be introduced into a food waste disposer and be discharged to the drainage system. Eggshells, if in quantities such as might be derived from egg drying and dehydrating plants, may create a serious drainage stoppage and should, therefore, be ground only with sufficient quantities of vegetable materials to cause movement through the drain.

Note: Prior to the installation of food waste disposers in any multiple dwelling, consideration should be directed to the waste piping system for the building, the proposed location and method of connecting the disposers, whether single or two compartment sinks are to be used, the model of the disposer to be installed, as well as any dish-washing machines contemplated and the cold water pipe size and available hydrostatic water pressure.

(9) **FREE STANDING FIXTURES.** Single free standing fixtures such as island sinks, laboratory sinks, etc., may be served by a loop vent and waste pipe type connection. The maximum developed length of the drip section of the loop vent shall not exceed 8 feet. See following sketch.

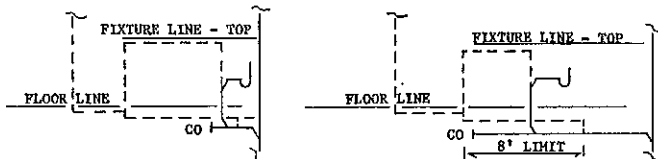

(10) **SPECIAL FIXTURES, EQUIPMENT, DEVICES.** (a) *Special fixtures.* Baptisteries, aquaria, ornamental ponds and fountain basins, industrial wastes and other specialties requiring waste connections or disposition shall be approved by the department prior to installation.

(b) *Bottling establishments.* Bottling plants shall discharge process wastes into an interceptor which will provide for the separation of solids prior to the liquid wastes entering the drainage system.

(c) *Clear water wastes.* Clear water wastes shall discharge to the storm water building drain system through an air-gap.

(d) *Dental cuspidors.* Dental cuspidors when connected to a waste pipe must be effectively trapped and vented as shown in sketch. The length of the horizontal waste pipe between the vent pipe and trap shall not exceed 15 feet. The total fall of the horizontal waste pipe between trap and vent shall not exceed the inside diameter of said waste pipe. See following sketch.

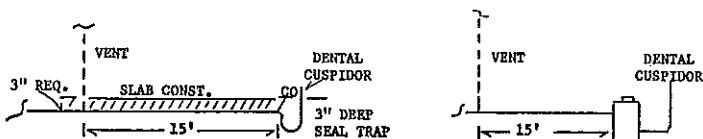

(e) *Drips or drainage outlets.* Appliances, devices, apparatus or appurtenances not regularly classed as plumbing fixtures and not included elsewhere in this code, but which have drips or drainage outlets shall be drained by indirect waste pipes discharging into an open receptacle through either an approved air-gap or air-break method.

(f) *Food preparation equipment.* Indirect waste pipe connections shall be provided for steam kettles, steam tables, potato peelers, coffee urns, egg boilers and other types of equipment. The indirect waste shall discharge through an air-gap or air-break, whichever is applicable, into a trapped and vented receptor.

(g) *Garbage can washers.* The drain outlet receiving the wash from garbage cans shall be at least 3 inches in diameter and shall be provided with a removable basket strainer to prevent discharge of large particles into the building drainage system.

(h) *Hydraulic machinery.* Hydraulic motors, hydraulic elevators or other machinery discharging large quantities of wastes shall be detained in a catch basin or receiving tank of sufficient size and so connected as to prevent the discharge of the wastes under pressure.

(i) *Refrigerated equipment.* The waste piping from refrigerators, refrigerated cases, coils or coolers, ice cube machines, vending machines or any equipment, receptacle or room in which provisions are stored shall not connect directly with any drain, soil or waste pipes. These drains shall be trapped as required to preclude their use as a local vent pipe. The length of the special waste pipe shall not exceed 20 feet. Special waste pipes shall be not less than 1 inch in diameter.

(j) *Slaughter houses.* Slaughtering rooms, meat processing and dressing room drains shall be equipped with approved separators or interceptors which will prevent the discharge into the drainage system of feathers, entrails, blood, manure and other materials likely to clog the drainage system. See Wis. Adm. Code section H 62.11 (4) (grease separators).

(k) *Swimming pools.* Pipes carrying waste water from swimming or wading pools, including pool drainage, backwash from filters and water from floor drains which serve decks around pools shall be installed as an indirect waste. Where the recirculation pump is used to discharge waste pool water to the drainage system, the pump discharge shall be installed as an indirect waste to the building drain or sewer. The regulations for sewer connections as established in Wis. Adm. Code chapter H 71 shall apply to private pools.

(l) *Self-service laundries.* Automatic clothes washing equipment in laundrettes, laundromats or other like public laundry establishments shall have the wastes discharge to a building sewer through a mani-

fold with standpipes served by properly sized and vented water sealed traps. The traps may be individually vented or circuit vented. Acceptable methods of installation are indicated in sketches. The following number of washers shall be the maximum to be connected to each size trap:

Table 6

TRAP SIZE (Minimum)	NO. OF WASHERS (Maximum)
2 inch trap -----	2 machines
3 inch trap -----	3 machines
4 inch trap -----	4 machines

Installation of gutters, troughs, local wastes, indirect manifold waste or other such connections are prohibited installations for the above type equipment. See following sketches.

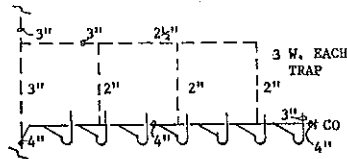
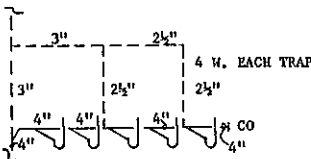
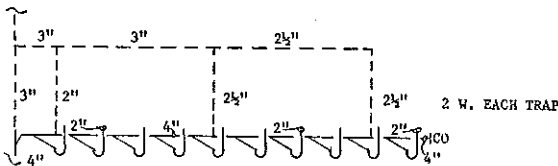
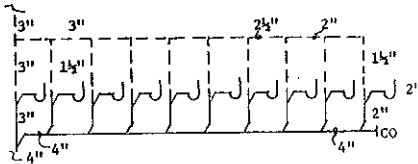
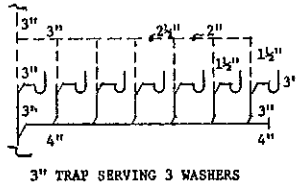
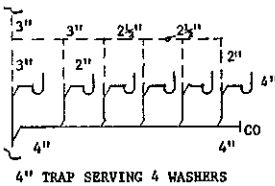

(m) *Vacuum cleaners (central units)*. Plumbing connected central vacuum power cleaning units shall be provided with an acceptable air-gap connection in the water intake pipe. The unit shall be connected to the waste piping system through an air-gap or air-break type connection.

(11) URINALS (a) *Women*. Urinals for women may be installed as an auxiliary or supplementary fixture. This type fixture is not to be used as a substitute for water closets. In all cases the minimum number of water closets required shall be provided.

1. Enclosure. The urinal shall be enclosed with a standard size water closet compartment and door to insure privacy in use. An instruction card explaining how to use the fixture shall be posted in each such compartment.

2. Installation. The fixture shall be installed in accord with all applicable code requirements set forth for water closets. A floor drain shall be installed immediately adjacent to the fixture. The fixture shall be equipped with an automatic flush tank, automatically controlled flush valve or a satisfactory foot operated flushing device. Every water supply to a urinal (s) shall be protected by an approved type vacuum breaker or other acceptable method.

(b) *Men's urinals*. 1. Stall type urinals shall be set into the floor and the floor shall be graded toward the fixture. A single urinal shall be flushed by an automatic flush tank, an automatically controlled flush valve or a satisfactory foot operated flushing device. A battery of not more than 4 urinals shall be flushed by an automatic flush tank or an automatically controlled flush valve provided the flush pipe is sized and graded as to insure sufficient pressure and volume for adequate flushing at each urinal. Every water supply to a urinal (s) shall be protected by an approved type vacuum breaker or other acceptable method. Batteries of urinals shall be spaced not less than 30 inches center to center. The center line of a single urinal shall be at least 16 inches from the nearest side wall or partition. When the space between stall type urinals or a urinal and a side wall is less than 12 inches, such space shall be filled in flush with the front and top of the urinal with nonabsorbent material.

2. Wall type. a. Wall hanging men's urinals of a type approved by the department may be installed in buildings other than service stations, schools, institutions or places of assembly where children under 12 years old are accommodated.

b. A single urinal shall be flushed by an automatic flush tank, an automatically controlled flush valve or a satisfactory foot operated flushing device. A battery of not more than 4 wall hanging washout urinals shall be flushed by an automatic flush tank or an automatically controlled flush valve provided the flush pipe is sized and graded as to insure sufficient pressure and volume for adequate flushing at each urinal. Every water supply to a urinal (s) shall be protected by an approved type vacuum breaker or other acceptable method.

c. Batteries of wall hanging urinals shall be spaced not less than 30 inches center to center. The center line of a single urinal shall be at least 16 inches from the nearest side wall or partition.

d. Wall hanging urinals shall be supported by a carrier fitting.

e. Combinations of stall type and wall hanging urinals may be installed.

f. A floor drain located not more than 12 inches from the wall supporting wall hanging urinals, or a stall urinal shall be provided for each group of 4 or less urinals and each toilet room containing a single wall hanging urinal.

g. Fixture unit values, trap, waste and vent sizes shall be the same as men's stall urinals.

h. Excepting for buildings referred to in section H 62.08 (11) (b) 2., any building in which juveniles may be present containing a toilet room having only one water closet and one urinal, the urinal shall be the stall type. If said building contains a toilet room having more than one urinal, at least one urinal shall be installed in accord with section H 62.08 (13) (e).

i. Excepting for buildings referred to in section H 62.08 (11) (b) 2., any building in which juveniles may be present containing a toilet room having only one water closet and one urinal, the urinal shall be the stall type. If said building contains a toilet room having more than one urinal, at least one urinal shall be installed in accord with section H 62.08 (13) (e).

(12) **WATER CLOSETS.** (a) *Floor outlet.* One floor outlet water closet may connect to a 3 inch horizontal or vertical soil pipe through a 4 X 3 inch bend. Not more than 2 water closets shall be connected to a 3 inch vertical soil pipe. Offset or 3 X 4 inch closet collar connections are prohibited.

(b) *Back to back floor outlet.* Two water closets located back to back shall be connected to a vertical 3 inch pipe with a 3 inch tee-wye cross. Two floor outlet water closets located back to back may connect to a vertical 4 inch stack through a 4 X 3 inch sanitary cross or through a 4 inch sanitary cross fitting. When fixtures discharge into the same soil pipe above the water closets, all fixtures shall be properly vented. Back to back floor outlet water closets connecting to a horizontal soil pipe shall be connected by the proper use of 45° wyes, double wyes, tee-wye combinations or with fittings producing a like radius and may be circuit vented or individually back vented. See section H 62.08 (1) (c) for vertical limitations.

(c) *Side by side floor outlet.* Floor outlet water closets installed side by side or in batteries shall connect to the horizontal soil pipe through a horizontally installed wye, tee-wye or wye and $\frac{1}{8}$ bend. The fixtures may be individually back vented or circuit vented. Where circuit vents are used, the size shall be: 3 inch for a battery of 2 to 6 fixtures and 4 inch for a battery of 7 or 8 fixtures.

(d) *Wall outlet floor mounted water closets.* Wall outlet floor mounted type water closet fixtures may be connected to a vertical or horizontal soil pipe through an approved type carrier fitting or 4 inch closet collar. When the soil piping is 3 inches in diameter, the pipe connection shall be increased to 4 inch inside diameter between the fixture and soil pipe fitting connections.

(e) *Back to back wall outlet.* Wall outlet, floor mounted type water closets connected to the same vertical soil pipe shall be installed with a fitting so designed as to prevent cross-flow of wastes or air pressures to the opposite fixture, or through an approved type carrier fitting. Where fixtures discharge into the same vertical pipe on floors above, all fixtures shall be properly vented. Wall outlet, floor mounted water closets may discharge into a horizontal soil pipe through an approved type carrier fitting. The water closets may be individually

back vented, served by a 3 inch diameter common vent or a 2 inch diameter common vent increased to 3 inches in diameter a maximum vertical distance of 18 inches above the center line of the fixture opening, with no horizontal offset in the vent pipe below a point 38 inches above the floor line.

(f) *Side by side wall outlet.* Wall outlet floor mounted water closet fixtures installed side by side or in batteries shall connect to the horizontal or vertical soil pipe through an approved carrier type fitting, a wye, tee-wye or wye and 1/8 bend connection. The fixtures shall be individually dry vented.

(g) *Off the floor water closets.* 1. Batteries of side by side off the floor type fixtures shall connect to a horizontal or vertical soil pipe through department approved horizontal or vertical carrier type fittings and shall be individually dry vented.

2. Off the floor type water closets installed back to back shall connect to horizontal soil pipe through a department approved type carrier fitting. The water closets may be individually back vented, served by a 3 inch diameter common vent or a 2 inch diameter common vent increased to 3 inches in diameter a maximum vertical distance of 18 inches above the center line of the fixture opening with no horizontal offset in the vent pipe below a point 38 inches above the floor line.

(h) *Stack offsets.* Off the floor type water closets shall be connected to a stack offset through an approved back to back carrier type fitting. The installation shall be served by a unit vent of 3 inch or larger diameter, or may be individually back vented in accord with section H 62.03 (1), table 1. Also see section H 62.06 (1) (c).

(i) *Multi-story stacks.* Back to back off the floor water closets shall connect to a vertical soil stack through a department approved back to back carrier type fitting. The water closets may be individually back vented, served by a 3 inch diameter common vent or a 2 inch diameter common vent increased to 3 inches in diameter a minimum vertical distance of 18 inches above the center line of the fixture opening with no horizontal offset in the vent pipe below a point 38 inches above the floor line.

(13) BATHROOM GROUPS. (a) *Bathroom group (single).* A single group of bathroom fixtures may be installed without individual fixture vents in a one story building or on the top floor of a building provided that:

1. The water closet is independently connected to a stack 3 inches or larger with no more than 1 D.F.U. connection above. See following sketch.

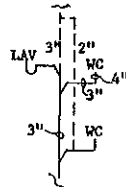
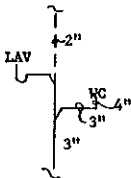

2. The drain from a back vented lavatory serves as a wet vent for a bathtub or shower stall. See following sketch.

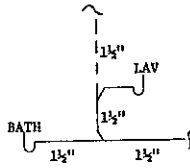

3. Not more than 1 D.F.U. is drained into the 1 1/2 inch vertical vent or not more than 5 D.F.U. drain into the horizontal wet vented pipe. See following sketch.

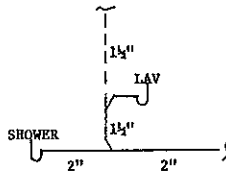

4. The horizontal wet vented pipe shall connect to the stack at or below the same level as the water closet drain when installed on the top floor. See following sketch.

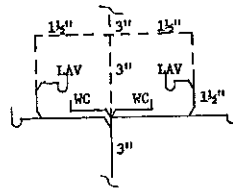
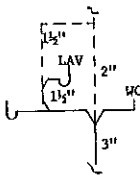

(b) *Double bathroom groups.* Back to back bathroom groups consisting of 2 lavatories and 2 bathtubs or shower stalls may be installed on the same horizontal pipe when served by a 2 inch diameter unit vent provided the water closets (2) connect independently to a 3 inch or larger diameter stack which extends full size without fixture connections above. See following sketches.

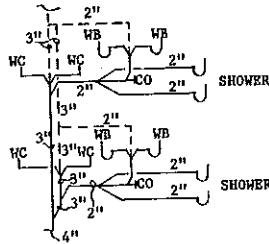
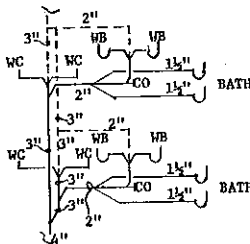

(c) *Other fixtures.* A horizontal soil or waste pipe to which 2 and not more than 8 like fixtures are connected may be vented by a circuit

vent. The horizontal soil or waste pipe shall be carried full diameter to the last fixture connection and terminate with a cleanout. See following sketch.

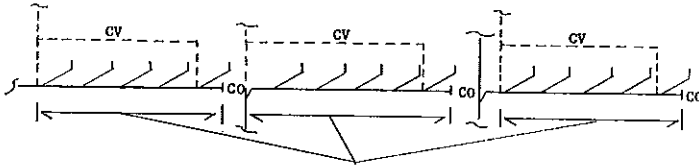

NO CONNECTIONS IN THIS AREA EXCEPT LIKE FIXTURES SERVED BY CIRCUIT VENT.

(d) *Prohibited fixture connections.* There shall be no fixture connection other than the circuit vented fixtures connected to the circuit vented horizontal soil or waste pipe.

(e) *Juvenile fixtures.* Water closets and other fixtures for the use of juveniles shall be of a size and shall be installed at a height suitable for juveniles use. Drain connections shall be provided at height required to serve the fixtures.

(14) **UNLISTED FIXTURES, EQUIPMENT, DEVICES AND APPLIANCES.** For items not included in this section, refer to other applicable sections of this chapter or contact the department for information and proposed installation review.

(15) **INDIRECT WASTE PIPING AND SPECIAL WASTES. SPECIAL EQUIPMENT, INDIRECT WASTE PIPING.** (a) *Piping by plumber.* The indirect waste piping serving any refrigerator, refrigerator case, icebox, ice compartment, vending machine, rinse sinks, steam tables, steam kettles, potato peelers, egg boilers, coffee urns, appliances, devices or appurtenances in which food or provisions are stored or processed, baptismal founts, clothes washers and extractors, dishwashers, dental cuspidors, garbage can washers, appliances, devices or appurtenances such as stills, sterilizers, bar and soda fountains, boiler blow-off basin outlet drains and similar equipment having public health concern shall be installed by licensed plumbers.

(b) *Piping by equipment installers.* Indirect waste piping serving air-conditioning, cooling coils, air-handling condensate waste, expansion tank overflow and equipment serving steam, power, heating, such as flash tanks, boiler to blow-off basins, machinery wastes, process piping and similar waste piping may be installed by the equipment installer.

History: 1-2-56; r. and recr. Register, October, 1971, No. 190, eff. 11-1-71; am. (1) (b), (d), (2) (c), (3), (8) (c), (11) (b) 2, d, e, f, g, h., (12) (e), (g) 2, r. and recr. (5), Register, November, 1972, No. 203, eff. 12-1-72.

H 62.09 Fixtures. (1) CONSTRUCTION AND DESIGN. All fixtures, appliances, equipment, devices and appurtenances shall be of such design, materials and construction as to comply with applicable standards to insure durability, proper service, sanitation, and so as not to entail undue efforts in keeping them clean and in proper operating condition. All fixtures shall connect directly to the sanitary plumbing system except as otherwise indicated. Blowout type fixtures of any type may only be installed upon approval of the department.

Register, November, 1972, No. 203

(2) **FIXTURE OUTLETS.** Outlet passageway shall be free from impairments and of sufficient size to insure proper discharge of the fixture contents under normal conditions. Outlet connections which are directly connected to the plumbing system shall be such that a permanent air and watertight joint can be readily made between the fixture and drainage system.

(3) **MATERIALS.** Fixtures shall be made of earthenware, vitreous chinaware, enameled steel or ironware, stainless steel or other approved materials. Wooden trays or sinks with or without metallic lining shall be allowed only in commercial laundries and dye houses where such fixtures are in daily use.

(4) **BATHTUBS.** Bathtubs shall be designed in conformity to applicable standards and shall have waste outlets and overflows at least 1½ inches in diameter. The waste outlet shall be equipped with a suitable stopper or closing device. Bathtubs set in any alcove shall have the side with the longest dimension accessible for entry to the tub.

(5) **DRINKING FOUNTAINS AND DEVICES.** Drinking fountains, coolers and like devices shall not be installed in toilet rooms. All drinking fountains, coolers and like devices shall be separate from other fixtures and be made of earthenware, vitreous chinaware, enameled steel or ironware, stainless steel, anodized aluminum, or other approved material. The bowl shall be so designed and proportioned as to be free from corners so that it may be readily cleaned and so as to prevent unnecessary splashing at the point where the jet stream falls into the bowl. The nozzle shall be of nonoxidizing impervious material and shall have no fouling space or enclosures making cleaning difficult or inducing insanitary conditions. The jet shall be inclined and the orifice shall be higher than the rim of the waste water receiving bowl. The water supply shall be provided with an adjustable valve fitted with a loose key or an automatic self-closing valve permitting regulation of the rate of flow of water. The water supply issuing from the nozzle shall be of sufficient volume and height so that persons using the fountain need not come in direct contact with the nozzle or orifice. To accomplish this, the fountain supply should be equipped with an efficient automatic pressure and volume regulating valve. See section Ind. 52.12 (9), Wis. Adm. Code.

(6) **LAUNDRY TRAYS, SINKS.** Laundry trays and each sink compartment shall be provided with a waste outlet of at least 1½ inch diameter.

(7) **LAVATORIES (WASH BASIN).** Each fixture shall have a waste outlet of at least 1¼ inch diameter. Each multiple type fixture with 18 inches of useable length of a straight-line or circular type shall be considered equivalent to one lavatory (wash basin) for the purpose of determining the water supply and drainage pipe sizes. Each 18 inch interval and each individual lavatory fixture shall be provided with potable water for hand washing.

(8) **SHOWERS.** (a) *Compartments.* Shower compartments shall have at least 900 square inches of floor area, curb at least 3 inches in height and shall be at least 30 inch in minimum dimension at any given side or angular shape or as the diameter of a circle except when a bathtub is used as the shower compartment. The wall area

above built-in tub showers and in shower compartments shall be constructed of smooth, noncorrodible, nonabsorbent, waterproof materials to a height of at least 6 feet above the floor level. The walls shall form a watertight joint with each other and with either the tub, receptor or shower floor. Preformed and prefabricated units shall comply with this subsection.

(b) *Waste outlet.* Waste outlets serving single showers, other than those in bathtubs, shall be at least 2 inches in diameter. When gang showers are to be served, the minimum drain outlet shall be 3 inches in diameter. Strainer perforations or slots shall be no smaller than $\frac{1}{4}$ inch. Where gang showers are installed, the waste outlet should be so located and the floor so pitched that waste water from one shower head does not flow over the floor area serving another shower head.

(c) *Safing.* All shower stalls, shower rooms, floor setting service sinks or receptors, sunken bathtubs or other like fixtures shall be provided with 4 pound sheet lead asphaltum coated, compotite, copper, saraloy or other approved safing material beneath the entire fixture or room and upward along the sides to a minimum of 6 inches above the curb or maximum water level of the fixture. The corners shall be safed to a height of 6 feet and at least 3 inches in each direction from the corners. The safing shall be properly drained. Unitized receptors, manufactured floor setting service sinks, shower receptors, bathtubs and installations directly over an unexcavated portion of a building are exempt from safing requirements.

(d) *Shower drains and floor drains.* Shower drains and floor drains shall be considered a fixture and shall be provided with an approved strainer.

(9) **URINALS.** (a) *General.* Urinals shall be made of material impervious to moisture and which will not corrode under the action of urine, be of such design, materials and construction that they may be properly flushed and kept in a sanitary condition. If cast iron is used in the construction of urinals, it must be enameled on the inside and coated with durable paint or be enameled on the outside. No sheet iron urinals will be permitted. Only individual urinals shall be used in public buildings and places of employment. Such individual urinals shall be of vitreous china or stainless steel and shall be equipped with an automatic flushing device.

(10) **WATER CLOSETS.** (a) *General.* All water closets shall be designed to meet specification standards for land use fixtures. They shall hold a sufficient quantity of water and be of such shape and form that no fecal matter will collect on the surface of the bowl. All water closet bowls shall be equipped with adequate flushing rims so as to flush and scour the bowl properly when discharged. Water closet seats shall be of wood or other nonheat absorbing material. See Wis. Adm. Code section Ind 52.59 (2).

1. In public buildings, places of employment, and all other public places except in apartments and guest rooms in hotels and motels, the water closets shall be of the elongated or extended lip design.

2. Except in apartments and guest rooms in hotels and motels, water closet seats shall be open front seats without cover.

3. Water closet seats in guest rooms in hotels and motels shall be open front with or without cover.

(b) *Side inlet water closet bowls.* New water closet installations shall not be equipped with side inlet openings.

(c) *Fixture flushing.* Each water closet shall be individually equipped with an acceptable flush tank and fittings or with an approved flushometer valve. All flush tanks, flushometer or automatic flushing device shall be readily accessible for maintenance and repair. Ballcocks shall be of the anti-siphon type.

(d) *Prohibited water closet fixtures.* It shall be unlawful to install and/or maintain pan, plunger, offset washout, washout, long hopper, frostproof and/or other water closets having invisible seals or unventilated spaces or walls not thoroughly cleansed at each flushing.

(11) **OVERFLOWS.** (a) *Design.* In any fixture which is provided with an overflow, the waste outlet shall be designed and installed so that the standing water in the fixture cannot rise in the overflow when the stopper is closed, nor shall any water remain in the overflow when the fixture is empty.

(b) *Connection of overflows.* The overflow from any fixture shall discharge into the drainage system on the inlet or fixture side of the trap provided that the overflow from a flush tank serving a water closet or urinal shall discharge into the fixture served.

(12) **WATER HEATERS AND HOT WATER STORAGE TANKS.** (a) *General.* All water heaters either for domestic or industrial use shall be of an approved type and shall connect to the water distribution system in an approved manner. All heaters except electric heaters shall be provided with a flue of rust resistant material connected to a chimney or gas vent stack. All water heaters shall be permanently marked with the rated input of the heater in B.T.U. or watts. Such marking shall be in an accessible position on the outside of the heater for inspection purposes.

(b) *Safety devices.* All safety devices, except mixing valves, shall meet the current requirements of one or more of the following: American Gas Association, Underwriters Laboratories, Inc., American Society of Mechanical Engineers or National Board of Boiler and Pressure Vessel Inspectors. Test and certification by a laboratory in accordance with one of the above applicable standards shall also be considered acceptable. All water safety devices shall be of the temperature and pressure type installed in accordance with this code.

Note: The above standards are on file in the offices of Health and Social Services, Secretary of State, and Revisor of Statutes, and may also be obtained for personal use as follows:

1) Approval requirements for gas water heaters, volume I, Seventeenth Edition, 1965.

Approval requirements for gas water heaters, volume II, effective January 1, 1963.

Approval requirements for gas water heaters, volume III, third edition, 1965. Listing requirements for relief valves and automatic gas shutoff devices for hot water supply systems, effective January 1, 1965 and addenda effective January 1, 1966.

The above standards are available from American Gas Association, Inc., 605 Third Avenue, New York, New York 10016.

2) Standards for safety, household electric storage-tank water heaters, UL 174, third edition, May 1, 1970, and revision pages dated June 16, 1971, January 18, 1971.

The above standards are available from:

Underwriters' Laboratories, Inc.
207 E. Ohio Street, Chicago, Ill. 60611
333 Pfingsten Road, Northbrook, Ill. 60062
1655 Scott Blvd., Santa Clara, Calif. 95050
1285 Walt Whitman Road, Melville, L. I. N. Y 11746

3) ASME Boiler and Pressure Vessel Codes, Heating Boilers, section IV, 1971, available from American Society of Mechanical Engineers, 29 W. 39th Street, New York, N. Y. 10018.

4) Relieving capacities of safety valves and relief valves, January 1, 1970.

The above standards are available from The National Board of Boiler and Pressure Vessel Inspectors, 1155 N. High Street, Columbus, Ohio 43201.

(c) *Tank construction.* Storage tanks for direct fired storage type water heaters shall be constructed to withstand a minimum of 300 psi test pressure without leakage or permanent distortion and shall bear the manufacturers' marking showing test and working pressure, except that in lieu thereof, pressure markings appearing on AGA or UL listed water heater units will be considered acceptable.

History: 1-2-56; r. and recr. Register, October, 1971, No. 190, eff. 11-1-71; am. (6) and r. and recr. (10) (a), Register, November, 1972, No. 203, eff. 12-1-72.

H 62.10 Traps and cleanouts. (1) *TRAP SIPHONAGE.* Every fixture trap seal shall be protected to prevent siphonage or back pressure by insuring air circulation with an approved vent in compliance with this code. In no case shall a vent be connected at the crown of a trap.

(2) *TRAP CONSTRUCTION.* (a) *Design.* No trap which depends upon the action of movable parts for its seal shall be used. No trap shall be used which depends upon concealed interior partitions for its seal unless such interior partitions are made of indestructible material. No trap shall be used which in case of defect would allow the passage of sewer air. No rubber or wicking packed slip joint connection shall be installed on the sewer side of a fixture trap. Slip joint waste connections on the sewer side of the trap shall be ground faced or equal and shall not be concealed or enclosed.

(b) *Cleansing.* Every trap shall be self-cleaning. Floating and sedimentary solids in the seal of the trap shall be removed by a normal discharge from the connected fixture. Uniform diameter traps shall be considered self-cleaning.

(c) *Material.* The material for traps shall be either vitreous china, clay, lead, brass, copper, borosilicate glass, cast iron or malleable iron. Cast iron traps shall be coated on the inside and outside with rustproof coating.

(d) *Depth of seal.* The water seal of all fixture traps shall be at least 2 inches. A deep seal trap shall have a water seal of 4 inches.

(e) *Approval.* Every trap, P.O. plug and trap extension tubing shall have the maker's name, or registered trademark, cast or stamped upon the exterior surface thereof. Traps varying from standard design shall have the approval of the department before being used in any installation.

(3) *TRAP INSTALLATIONS.* (a) *Setting of traps.* All traps shall be so located as to be accessible, rigidly supported and set true with respect to their water level and so located as to protect their seals, and where necessary, shall be protected from freezing and evaporation.

(b) *Traps where prohibited.* No fixture shall be double trapped and there shall be no traps at the base of soil or waste stacks.

(c) *Bath traps.* Drum traps not less than 4 inches in diameter and having a seal of not less than 2 inches may be used under all bathtubs wherever practicable. The horizontal distance between the verti-

cal center line of the drum trap inlet to the center line of the fixture waste outlet shall not exceed 12 inches.

(d) *Deep seal traps.* Deep seal resealing traps of the centrifugal self-scouring type may be used when it is impractical to provide a proper back vent. So far as practical a free circulation of air shall be provided. Traps of this type shall not be permitted in new construction or reconstruction.

(4) **PROHIBITED TRAPS.** Bell, pot, and bottle traps, $\frac{3}{4}$ "S", full "S" type traps, traps fabricated from fittings, crown vented traps and traps constructed of masonry are not permitted.

(5) **CLEANOUTS.** (a) *Size.* Cleanouts shall be sized according to table 7. See following table and sketch.

Table 7
IRON BODY FERRULES WITH BRASS SCREW PLUG

Pipe Size (inches)	Dimensions in inches						Weight without plug (pounds)	
	C	F	I. P. S. Tapping	Tapping depth of G	K	R	'XH'	'SV'
2		3 $\frac{1}{2}$	1 $\frac{1}{2}$	1 $\frac{1}{2}$	2	1 $\frac{1}{4}$	1 $\frac{1}{2}$	1 $\frac{1}{4}$
3		3 $\frac{3}{4}$	2 $\frac{1}{2}$	1 $\frac{3}{4}$	3	1 $\frac{3}{8}$	2 $\frac{3}{4}$	2
4		4 $\frac{1}{2}$	3 $\frac{1}{2}$	1 $\frac{3}{4}$	4	1 $\frac{1}{2}$	4	3
5		4 $\frac{1}{2}$	4	1 $\frac{3}{4}$	5	1 $\frac{1}{2}$	5	3 $\frac{1}{4}$
6		4 $\frac{1}{2}$	5	1 $\frac{3}{4}$	6	1 $\frac{1}{2}$	6	4 $\frac{1}{4}$
8	7 $\frac{3}{8}$	4 $\frac{1}{2}$	6	1 $\frac{3}{4}$	8	1 $\frac{1}{2}$	12	9
10	7 $\frac{1}{2}$	4 $\frac{1}{2}$	6	1 $\frac{3}{4}$	10	1 $\frac{1}{2}$	20	15
12	7 $\frac{1}{2}$	5 $\frac{1}{4}$	6	1 $\frac{3}{4}$	12	2 $\frac{3}{8}$	28	21
15	7 $\frac{1}{2}$	5 $\frac{1}{4}$	6	1 $\frac{3}{4}$	15	2 $\frac{3}{8}$	43	30

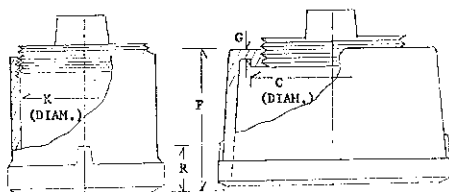

(b) *Building drain.* A cleanout with brass screw cover or other type approved by the department shall be provided at a point where the building drain leaves the building. This cleanout shall be extended from the building drain with a cast iron soil pipe to the surface of the finished floor or grade and wherever practical shall be not less than 2 inches above the finished floor or grade. An additional cleanout located at a point 28 to 30 inches above the floor shall be provided in all soil and waste stacks.

(c) *Toilet and washrooms.* Cleanouts shall be provided in connection with batteries of water closets, urinals, wash basins, sinks and showers, at such points that all parts of the branch waste and soil pipes may be reached conveniently for cleaning or removal of stoppages.

(d) *Sink wastes.* Waste pipes from sinks or other similar fixtures discharging greasy wastes shall have sufficient accessible cleanouts spread over their entire length.

(6) TRAP CLEANOUTS. All fixture traps shall be so designed and installed that stoppages may be removed. All small fixture traps shall be provided with cleanouts of the screw plug or removable dip type. Where the "U" or dip is removable the coupling nut on the discharge side shall be within the dip of the trap. Traps for urinals rising from the floor and traps serving shower baths and floor drains, when inaccessible, shall be so installed as to make the removable inlet serve as a cleanout.

(7) CONSTRUCTION. The bodies of cleanout ferrules shall be made of cast iron or brass and shall extend not less than 1/4 inch above the hub receiving it. Brass screw caps for cleanouts shall be in accord with table 8 and the following sketch. Solid head brass cleanout plugs shall be used when the cleanout plug is drilled and tapped to provide access cover extensions or escutcheons. The depth of the drilling and tapping shall not exceed 75% of the thickness of the cleanout plug head. The hole and tapping shall not penetrate the cleanout plug. See following sketch. Adequate inverted or countersunk sockets may be substituted for square or hexagonal heads where applicable. The ferrules when constructed of brass shall be at least 3/16 inch in thickness and when constructed of iron the same weight per foot as for cast iron soil pipe. The screw thread shall have at least 5 threads of iron pipe size. A brass plug of standard pipe size shall be used where threaded metal drainage fittings serve as cleanout openings. Plastic cleanout plugs shall be used where plastic drainage fittings serve as cleanout openings.

Table 8
SCREW PLUGS (BRASS) 'XII' AND 'SV'

Size (inches)	Dimensions in inches							Weight (pounds)	
	A	B	C	D	E	G	Across flats H ¹		L (see note)
1 1/4	1/2	1/2	3/4	1 1/2	5/8	1 1/8	1	5/8	1 1/4
1 1/2	5/8	3/4	3/4	1 1/2	5/8	1 1/8	1	5/8	1 1/2
2	5/8	3/4	1	2	5/8	1 1/8	1 1/4	5/8	2
2 1/2	5/8	3/4	1 1/8	2 3/8	5/8	1 1/8	1 1/4	5/8	2 1/2
3	5/8	1	1 1/8	2 5/8	5/8	1 1/8	1 1/4	5/8	3
3 1/2	5/8	1	1 1/4	3 1/8	5/8	1 1/8	1 1/4	5/8	3 1/2
4	5/8	1	1 3/8	3 3/8	5/8	1 1/8	2	5/8	4
5	1	1	1 5/8	4 1/8	5/8	1 1/4	2 1/2	5/8	5
6	1	1	1 7/8	5 1/8	5/8	1 1/4	2 3/8	5/8	6

¹Heads of plugs shall be either square or hexagonal. Dimension H is taken between opposite sides of either style used.

NOTE: When thread gauge is screwed tightly on plug by hand, large end of gauge shall be the distance "L" plus or minus 1 1/2 turns, from surface of plug.

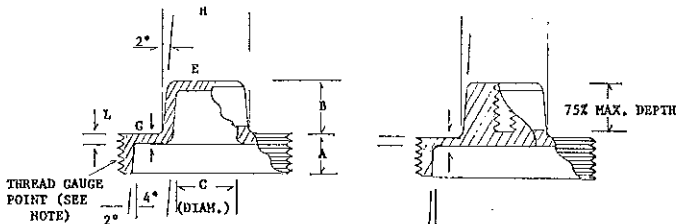

History: 1-2-56; am. (1), (4) and (5), Register, February, 1957, No. 14, eff. 3-1-57; r. and recr., Register, October, 1971, No. 190, eff. 11-1-71; am. (3) (d), (5) (a) and (7), Register, November, 1972, No. 203, eff. 12-1-72.

Register, November, 1972, No. 203

H 62.11 Interceptors, sumps, ejectors and special and industrial wastes. (1) **INTERCEPTORS.** (a) *Where required.* Any waste materials other than domestic wastes which upon discharge may congeal, coagulate or accumulate in drains or sewers, thereby creating stoppages retarding normal flow rates, or which may retard or interfere with normal sewage treatment processes, or which may pass through the treatment processes so as to pollute the watercourse receiving the treatment plant effluent, or which may create explosive, flammable, noxious, toxic, or otherwise hazardous mixtures of materials, or which may damage, destroy, or deteriorate sewers, or piping structures and/or materials, shall be directed to an interceptor or other approved device capable of separating with proper care and maintenance, all harmful, dangerous, or deleterious materials from regular sewage materials retaining the deleterious materials in the interceptor or device to facilitate periodic removal and/or treatment. See Wis. Adm. Code Chapter Ind 8, Flammable Liquids.

(b) *Private systems.* Where any above indicated wastes from any plumbing system are not discharged into a public sewer, such wastes shall be treated or disposed of in compliance with methods approved by the state department having jurisdiction and shall be installed so as not to endanger any water supply that is or may be used for drinking, culinary or bathing purposes, or which may create a nuisance, insanitary conditions or water pollution.

(c) *Velocity control.* Interceptors shall be designed, sized and installed so that flow rates shall be developed and maintained in such a manner that solid or floating materials of a hazardous or deleterious nature will be collected in the interceptor for disposal.

(d) *Maintenance.* All devices installed for the purpose of intercepting, separating, collecting, or treating harmful, hazardous or deleterious materials in liquid or liquid-borne wastes shall be properly operated and shall be cleaned of intercepted or collected materials, or any residual from treatment at such intervals as may be required to prevent their introduction into the plumbing, drainage or sewerage systems.

(e) *Service reassembly.* Any fixed orifice, vent or trap shall remain intact and shall not be removed or tampered with except for cleaning purposes. After service, all parts of the interceptor, collector or treatment device, such as baffles, weirs, orifice plates, channels, vents, traps, tops, and fastening bolts or screws shall be replaced in proper working position.

(f) *Location.* Interceptors, sumps and waste treatment devices shall be located so service, maintenance, repair and inspection may be readily accomplished. No interceptor or treatment device shall be surrounded or covered as to render it inaccessible for service or inspection. Any interceptor having its top more than 6 feet above the surrounding floor, or which has less than 30 inches clear space above its top or which has permanent equipment placed above or about it in a manner so as to prevent ready and repeated cleaning or inspection shall be deemed inaccessible and shall not be accepted.

(g) *Disposition of retained materials.* Harmful, deleterious or dangerous materials, after removal from any interceptor, sump or treatment device, shall not be introduced into any drain, sewer or

natural body of water without approval of state departments having jurisdiction.

(2) **CATCH BASINS.** (a) *General.* Catch basins shall be constructed in a water-tight and substantial manner of concrete masonry, brick masonry, concrete block masonry, precast reinforced concrete, cast iron, bitumastic enamel coated 12 gauge steel, vitrified clay or other materials approved by the department.

(b) *Design.* All catch basins shall be a minimum of 36 inches inside diameter and shall have a minimum depth of 48 inches. The outlet shall be provided with cast iron sanitary tee or inverted wye connection not less than 4 inches inside diameter and shall be submerged not less than 18 inches below the flow or waterline and shall terminate not less than 18 inches above the bottom of the catch basin. A cleanout shall be provided in the horizontal pipe. The catch basin shall have a fitted removable concrete, cast iron or steel cover of a thickness and strength to sustain weight or traffic to which it will be subjected. No catch basin shall be installed within 25 feet of any water well. See following sketch and Wis. Adm. Code section H 62.12 (6).

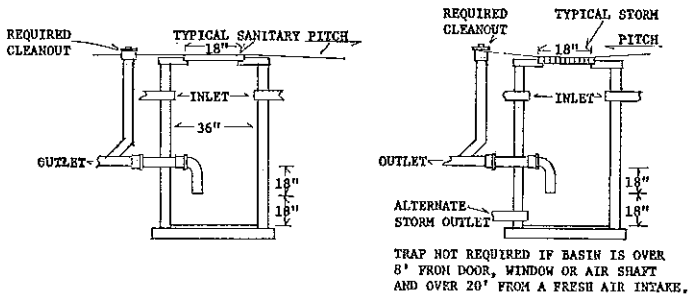

(c) *Catch basin.* All catch basins shall be constructed according to their intended use. When connected to a sanitary sewer, catch basins shall be located and designed to exclude storm and other clear water wastes.

(3) **CREAMERIES, DAIRIES AND MILK PASTEURIZING PLANTS.** (a) *Creamery and dairy wastes.* Waste piping from milk vats, sterilizers, or other receptacles or sinks used in creameries and milk houses shall be of the same size and material as waste piping from general use sinks. Creamery and milk house wastes shall discharge either onto a watertight floor having properly trapped floor drain connections discharging into the soil or waste systems or into a properly constructed sump or interceptor.

(b) *Milk pasteurizing plants.* Pasteurizing plants and/or milk bottling establishments shall direct all drains and wastes from any floor on which processing is conducted into an interceptor. The interceptor shall separate any harmful or deleterious materials before discharging its normal wastes to the plumbing system or building sewer.

(4) **GREASE INTERCEPTORS.** (a) *Where required.* All new or altered installations serving institutions or commercial establishments in which grease, fats, oils, or like waste products of cookery or process-

ing, or in which grease, fats or oils are wasted in connection with utensil, vat, dish or floor cleansing processes shall install grease interceptors acceptable to the department. All waste lines and drains carrying oil, grease or fats in the above type buildings shall be directed to one or more interceptors before connecting to the plumbing system.

(b) *Existing installations.* The department may require the installation of grease interceptors in existing installations where either the public or private sewers and/or drains become stopped due to congealed grease, either reducing or completely filling the waterway of the sewer or waste piping from the fixture or establishment from which greasy wastes are discharged.

(5) ACCEPTANCE AND TESTS. (a) *Tests.* The department shall require such tests on grease interceptors as may be deemed necessary to determine for each make, model or type, its grease collecting efficiency, the maximum effective grease capacity, the flow rate and characteristics of installation. These tests shall be performed in a laboratory acceptable to the department. If the size, type or design of an interceptor is beyond the testing facilities of available laboratories, the interceptor may be set up in a field installation under the direction of the department, and tests shall be conducted under supervision and control of departmental personnel. The department may review tests conducted by other laboratories, and if testing procedures and results are adequate and satisfactory to the department, the tests in whole or part thereof may serve in lieu of either laboratory or field tests, as above indicated.

(b) *Minimum required features.* 1. Flow rate. The minimum acceptable flow rating of any interceptor shall be 10 gallons per minute.

2. Materials and covers. Grease interceptors shall be constructed of durable, corrosion resistant, gastight and watertight materials and shall have gastight and watertight covers securely fastened in place.

3. Flow rate related to connected capacity. The total capacity measured in gallons of all fixtures and devices discharging to the interceptor shall not exceed $2\frac{1}{2}$ times the flow rate of the interceptor measured in gallons per minute.

4. Grease holding capacity as related to flow rate. The grease interceptor holding capacity in pounds shall not be less than double the value of the interceptors accepted flow rate measured in gallons per minute. (i.e. 2 gpm = 4 lbs.)

5. Flow controls. Devices which control the rate of flow through an interceptor shall be installed so as to be readily accessible for inspection, service or cleaning. If of the orifice type, each one shall be installed as close to the tailpiece of the fixture or machine served as fittings and available connections will allow.

6. Multiple connections to a common interceptor. Flow controls shall be installed in the waste branch leading to each fixture and shall be so rated that the combined flow from all combinations of discharge will not develop either sufficient static or velocity head so the established flow rate of the interceptor can be exceeded.

7. Prohibited locations and types. No water cooled grease interceptor shall be installed. No grease interceptor shall be located where surrounding temperatures, under operating conditions, are less than 40° F.

8. Flow control vents. Flow controls of the orifice type shall be vented in the sanitary plumbing system or be extended through the roof or through an outside wall. If extended through the roof or outside wall, the minimum size increaser shall be 2 inches. If vented through an outside wall, the vent shall terminate in a tee fitting whose run is vertical and above the normal passing traffic. See following sketch.

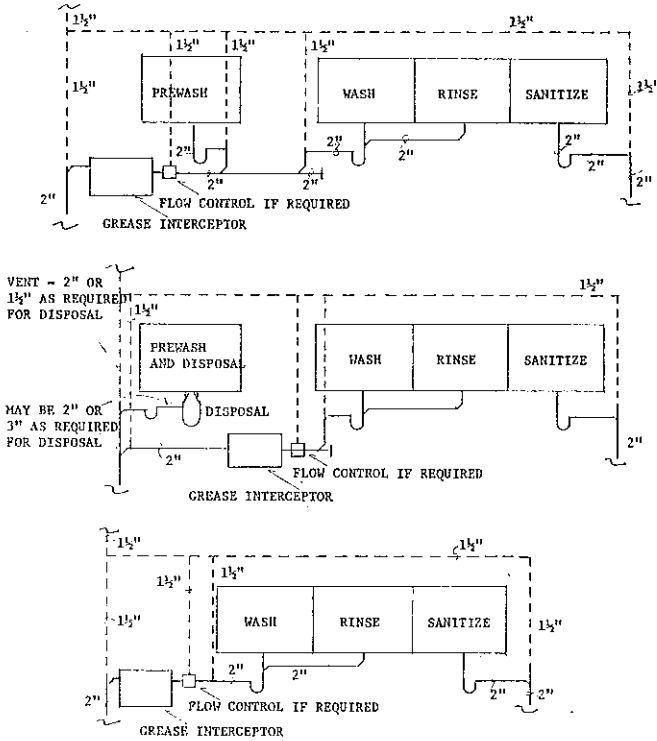

9. Prohibited discharge. No grease interceptor shall receive the discharge from a food waste grinder device.

(6) LAUNDRIES. (a) *Commercial laundry.* Each commercial laundry shall be equipped with an interceptor.

(b) *Design.* Laundry interceptors shall be equipped with a removable wire basket or other acceptable removable screening apparatus which will prevent the discharge of materials, such as lint, string, rags, buttons, etc., into the drainage system.

1. Laundry waste containing oils, sand or other solids shall, in addition to the above requirements, provide an acceptable method of interception for these materials as required elsewhere in this chapter.

2. If baskets are used, the minimum diameter of a laundry interceptor shall be 24 inches. The basket shall be of 1/4 inch mesh on the bottom and sides with a depth of not less than 24 inches. The basket shall be installed so as to cover the outlet of the interceptor.

The outlet shall be not less than 12 inches above the bottom of the interceptor. Duplicate baskets or screening apparatus should be provided for convenience in cleaning and maintenance.

(7) OILS AND FLAMMABLE LIQUIDS INTERCEPTOR. (a) *Volatile liquids.* All buildings discharging oily and/or flammable wastes to the sewer shall have one or more interceptors installed into which all such wastes shall be led. These normally include all commercial, storage or repair garages; gasoline stations with grease racks, grease pits, or wash racks; all auto laundries; and all factories which have such wastes as a result of manufacturing, storage, maintenance, repair or testing processes.

(b) *Separation of liquids.* 1. Site constructed separators. Oil separators constructed on the site shall have a depth of at least 24 inches below the invert of the discharge drain connected thereto. The outlet opening of the separators shall have a water seal of at least 18 inches.

2. Commercial interceptors. Commercial oil separators shall have sufficient capacity and be properly installed and maintained so they will serve the purpose for which intended. Iron oil separators shall be made of not less than 12 gauge copper bearing steel or cast iron. Manufacturers' ratings will be accepted with the approval of the department.

(8) DESIGN. (a) *Motor vehicle occupancies.* In automotive service stations, automotive repair shops and public garages where not more than 4 vehicles are both serviced and stored, separators shall have a minimum capacity of 6 cubic feet with 1 cubic foot added for each vehicle up to 10 vehicles. Where more than 10 vehicles are serviced, separator capacity shall be based on net capacity of 2 cubic feet for each 100 square feet of surface to be drained into the separator, with a minimum of 6 cubic feet.

(b) *Other occupancies.* In other buildings where oil or other flammable liquids are stored or used, no physical connection or internal arrangement that could permit the accidental or deliberate introduction of such materials directly or indirectly into the sewer system will be permitted. Where substances might overflow by spillage or other circumstances not caused by a direct connection of the plumbing system, protective dikes or similar devices shall be provided to prevent such substances from reaching the public sewers.

(c) *Oil storage.* Each separator shall have an oil storage tank available for storing the residue from the separator.

(d) *Sand interceptors.* Commercial establishments which require sand or similar interceptors for heavy solids shall be so designed and located as to be readily accessible for cleaning and shall have a water seal of at least 18 inches.

(e) *Venting.* Oil interceptors and separators shall be so designed that they will not become air bound if closed covers are used. Each interceptor or separator shall have an individual 3 inch vent extending from the top of the device to the outside atmosphere at a point at least 12 feet above street level. A fresh air inlet shall be provided from the drain line at the inlet side of the separator to the outside air at a point at least 12 inches above grade level. See Ind 8.22, Wis Adm. Code.

(f) *Accessibility and maintenance.* Each separator, interceptor or similar device shall be so installed as to be readily accessible for removing the cover for servicing and for maintenance. All units shall be maintained in efficient operating condition by periodic removal of accumulated grease, oil, scum, floating substance or other residue.

(g) *Construction.* Grease catch basins shall be constructed in the same general manner as provided for catch basins. The inlet and outlet shall be placed as far apart as possible and the depth below outlet flow line shall be not less than 2 feet. The inlet shall not be submerged, and not be more than 12 inches above the flow line of the outlet invert. Grease catch basins shall be provided with a removable airtight cover. Grease catch basins shall be provided with a removable airtight concrete, steel or cast iron cover. When bolted covers are provided, the bolts shall be of a non-corrosive metal. See following sketch.

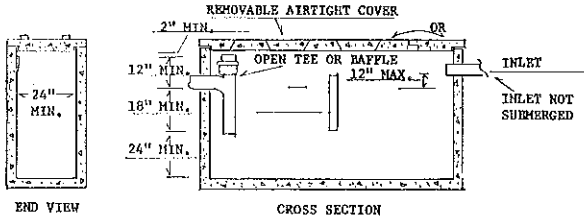

(9) **YARD CATCH BASINS.** (a) All building storm sewers used to drain paved areas, yards, courts, or similar areas may be connected directly with the storm sewer by means of a storm water inlet as specified in the following sketch.

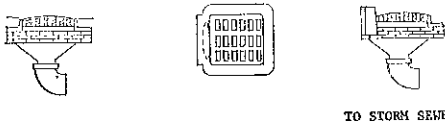

Where depth does not permit this type of storm inlet, a 36 inch vitrified clay or concrete manhole may be used. When such paved areas, yards, courts or similar areas are connected to an existing combined sewer, they shall first be intercepted in a yard catch basin. A yard catch basin shall be constructed in the same general manner as provided for catch basins; they shall be at least 36 inches in diameter and where possible the water level shall be at least 4 feet below finished grade. The outlet pipe or invert may be a tee installed in a vertical position with at least a 4 inch cleanout on top of the tee or a cast iron tee or wye in the horizontal plane. The outlet invert shall be submerged not less than 6 inches below the water line. The flow or water line shall not be less than 2 feet above the bottom. See following sketch.

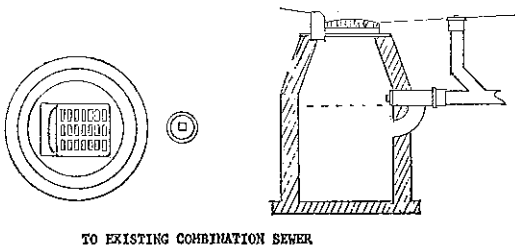

(b) The storm inlet or catch basin shall have an approved well fitted, removable, substantial cast iron or steel cover, strainer or grate of a thickness and strength to sustain the weight of anticipated traffic on it. The opening in such cover, strainer or grate shall be equal to or greater than the area of the sewer or waste outlet of the catch basin.

(c) A yard catch basin may be installed to receive surface drainage or discharge from a pump, hydrant, or other outside areas. It may connect only with a storm sewer or existing combined sewer when approved by the local authority. See Wis. Adm. Code section H 62.12.

(10) **STABLE CATCH BASINS.** When liquid wastes from barns, stables, manure pits and yards are permitted to enter the public sewer system, they shall be intercepted by a catch basin. See following sketch.

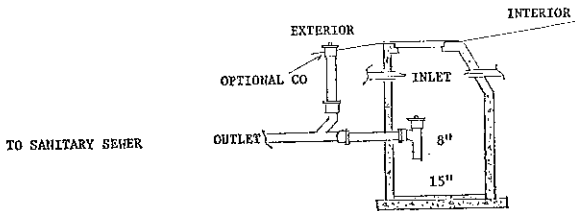

(11) **GARAGE CATCH BASINS.** Construction of garage catch basins or sand traps shall conform to general requirements for catch basins. The outlet invert should enter the walls of the basin so that the space between the water line in the basin and the floor level shall not exceed 10 inches. The outlet shall consist of a cast iron invert with a depth of invert of not less than 6 inches below the water line. The catch basin discharge pipe shall be provided with a full size cleanout. An open bar strainer not less than 24 inches in diameter shall be provided. Where it is impractical to keep the outlet within 10 inches of the floor level, a greater distance will be permitted. In such installations, a 4 inch local vent pipe shall be provided. Such local vent pipe shall enter the basin above the water line. Same shall terminate through roof or with a return bend outside of the building not less than one foot above the grade level. Where the nearly horizontal portion of the local vent does not exceed 50 feet, properly intercepted floor drains, not to exceed 4, may be connected individually to the lowest horizontal portion of the local vent. Properly intercepted floor drains may connect to the catch basin. The maximum developed distance from the local vent pipe or the catch basin to the trap outlet shall not exceed 32 feet and the total pitch off the pipe shall not exceed the inside diameter. Floor drains installed under this section shall have an inside diameter of at least 3 inches. See following sketch.

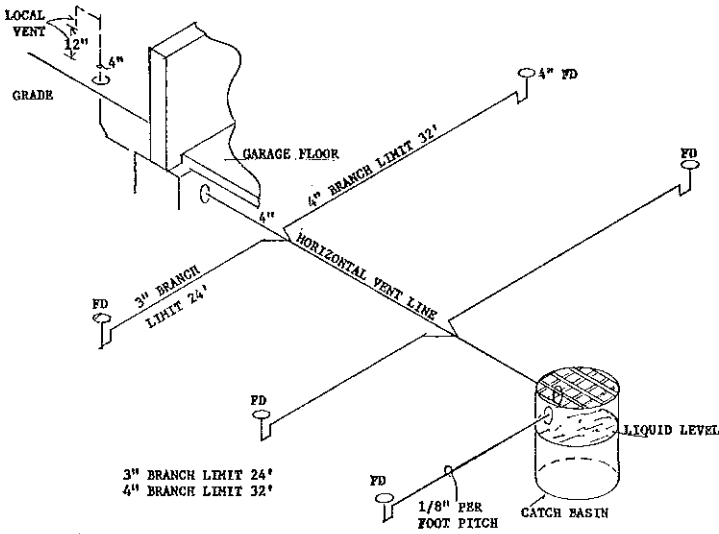

(12) **SUMPS.** (a) *Location.* All sanitary building subdrains shall discharge into an airtight and watertight sump or receiving tank, so located as to receive the drainage by gravity, from which sump or receiving tanks the drainage shall be lifted and discharged into the building drain or building sewer by pumps, ejectors or any other method approved by the department. All sumps installed for the purpose of receiving clear water, basement or foundation drainage water shall be located at least 15 feet from any water well. All other sumps shall be located at least 25 feet from any water well. See Wis. Adm. Code section H 62.12 (1) (b).

(b) *Capacity.* The capacity of a sump or receiving tank receiving sanitary wastes shall be determined by computing all possible drainage tributary to the sump. Storage capacity of the sump or receiving tank shall not exceed a 12 hour period.

(c) *Air inlet.* Any sump receiving domestic wastes shall have a fresh air inlet. The size of the air inlet pipe required will depend upon the size of the sump, varying from 2 inches to 6 inches. The air inlet pipe may be connected to a plumbing system vent pipe or extended separately through the roof and conform with the provisions of this code.

(d) *Materials.* All sumps or receiving tanks shall be constructed in a watertight and substantial manner of concrete, precast reinforced concrete, cast iron, bitumastic enamel coated 12 gauge or heavier steel, vitrified clay or other material approved by the department.

(13) **EJECTORS.** (a) *Where required.* In all buildings in which the whole or a part of the plumbing and drainage system lies below the flow line of the main sewer, the sewage and domestic wastes shall be lifted by mechanical means and discharged into the main sewer, building drain or building sewer. Duplex pumping equipment shall be

provided for other than one family dwellings or where 6 or more water closets discharge to the sumps serving the installation.

(b) *Size.* The size and design of an ejector pump shall be determined by the capacity of the sump to be served, the discharge head and discharge frequency. Manufacturers' ratings may be used provided the minimum discharge capacity exceeds 20 gallons per minute. In one family dwellings the ejector or pump with a water closet or water closets connected shall be capable of passing a 2 inch diameter solid ball. All other ejectors or pumps with a water closet or water closets connected shall be capable of passing a 2½ inch diameter solid ball. The discharge piping of each ejector or pump with a water closet or water closets connected shall be a minimum inside diameter of 3 inches.

(c) *Vent.* The drain leading to a sump or receiving tank shall, when a closet or closets are installed, be provided with a vent stack not less than 3 inches in diameter. Where fixtures other than closets are installed, the vent pipe size shall be determined from the tables in Wis. Adm. Code section H 62.03 (1) and (3).

(d) *Discharge connections.* The discharge pipe from the ejector to the building drain shall be connected through a branch Y fitting. The drain into which the ejector discharges shall be of sufficient size to receive the combined flow from the building and the ejector. Flanged connections and long radius fittings shall be used. Full flow check valves shall be installed in each sewage ejector line. Horizontal check valves shall be used where possible.

(e) *Venting ejector connection.* Fixtures located on a building drain near the point where such building drain receives the discharge from an ejector shall be effectively protected against siphonage, and an additional air relief or vent pipe shall be provided where necessary. No fixtures shall be connected to the discharge pipe from an ejector, between the ejector and the point where it enters the building drain or sewer.

(f) *Maintenance.* All ejectors and like appliances shall receive care as needed to keep them in a satisfactory operating condition.

(14) **ACID WASTE PIPING.** Acid waste and vent pipe shall meet the following criteria:

(a) *Temperature resistance.* Temperature resistance shall be guaranteed by the manufacturer for use at operating temperatures from 0 degrees to 200 degrees F. Continuous exposure, with intermittent exposure up to 250 degrees F., shall withstand repeated thermal variations of 130 degrees F.

(b) *Flammability.* The materials shall be nonburning when tested according to A.S.T.M. D-635-68.

(c) *Pressure.* Pressure shall be guaranteed by the manufacturer for use from full vacuum to 15 psi.

(d) *Chemical resistance.* Chemical resistance shall be guaranteed by the manufacturer for use with the following chemicals at temperatures to 200 degrees F., without reliance on dilution and flushing.

Acids
Acetic Acid 98% (glacial)
Formic Acid 90%
Hydrochloric Acid 20%
Hydrochloric Acid 37%
Nitric Acid 24%
Nitric Acid 30%
Nitric Acid 40%
Nitric Acid 70% (conc.)
Perchloric Acid
Phosphoric Acid 85% (conc.)
Sulfuric Acid 20%
Sulfuric Acid 33%
Sulfuric Acid 45%
Sulfuric Acid 77%
Sulfuric Acid 96% (conc.)

Bases
Ammonium Hydroxide 28%
Sodium Hydroxide 10%
Sodium Hydroxide 20%
Sodium Hydroxide 40%
Sodium Hydroxide 50%
Sodium Hydroxide Flake
Sodium Sulfide

Organics
Acetone
Benzene
Butyl Alcohol
Carbon Tetrachloride
Ethyl Acetate
Ethyl Alcohol
Formaldehyde
Furfural
Methanol
Methyl Ethyl Ketone
Naphtha
Oil (Nujol)
Phenol 85%
Pyridine
Toluene
Xylene

Salts
Potassium Dichromate
Potassium Hydroxide 10%
Potassium Permanganate (Sat.)
Sodium Chloride
Sodium Phosphate 5%
Zinc Chloride

1. All chemical wastes shall be thoroughly diluted, neutralized, or treated by passing through an approved dilution or neutralizing basin of proper capacity before discharging into the sanitary sewer. The waste water discharge shall be monitored periodically for purposes of maintaining a pH of 7.0 plus or minus 1.0.

2. Vent piping on chemical waste systems shall be of the same material as the chemical waste pipe and shall be extended independently through the roof.

3. Sizing dilution or neutralizing basins shall be in accord with table 9. For quantities of fixtures exceeding 150 sinks, or for special type use or installation, the department shall be consulted.

Table 9

1 sink	-----	5 gallon tank
4 sinks	-----	15 gallon tank
8 sinks	-----	30 gallon tank
16 sinks	-----	55 gallon tank
25 sinks	-----	100 gallon tank
40 sinks	-----	150 gallon tank
60 - 75 sinks	-----	250 gallon tank
100 sinks	-----	350 gallon tank
150 sinks	-----	500 gallon tank

4. When above capacities are to be served for neutralizing purposes without dilution process, the tank shall be filled to the level of the overflow (outlet) with marble or limestone chips of not less than 1 inch nor more than 3 inch diameter.

5. Vent pipe sizes serving dilution or neutralizing basins shall be in accord with table 10.

Table 10
BASIN VENT PIPE SIZES

2 inch for	1- 24 units (D.F.U.)
3 inch for	25-126 units (D.F.U.)
4 inch for	127 or more units (D.F.U.)

6. Basin vent terminals. Basin vent pipes may connect to the acid vent piping system or extend through the roof separately. A vent with a return bend may terminate outside the building at least 12

feet above grade, at least 8 feet from a door or openable window and at least 20 feet from a fresh air intake.

Note: Copies of standards promulgated by American Society for Testing Material are on file in the office of the revisor of statutes, secretary of state and health and social services and may be obtained for personal use from American Society for Testing Material, 1916 Race Street, Philadelphia, Pa., 19103.

History: 1-2-56; r. and recr. Register, November, 1972, No. 203, eff. 12-1-72.

H 62.12 History: 1-2-56; r. Register, October, 1971, No. 190, eff. 11-1-71.

H 62.12 Storm and clear water. (1) **DISPOSAL.** (a) *Storm sewer system.* Inside roof leaders, clear water wastes, groundwater drains, foundation footing, refrigerator cooling water, storm water drains, drinking fountains, air-conditioning, paved areas, parking lots, courts and other clear water wastes not described shall discharge to a storm sewer system where available.

(b) *Other disposal.* Where no storm sewer system is available or exists or is not adequate to receive the anticipated flow, the storm and clear water wastes shall be discharged in accord with local governmental requirements.

(c) *Prohibited discharge.* Storm and clear water wastes shall not discharge to a sewer carrying sanitary wastes.

(d) *Controlled roof drainage.* See Wis. Adm. Code section H 62.05 (4).

(2) **STORM SEWERS.** (a) *Materials and installation.* Materials and installation of storm sewers shall be as specified for sanitary sewers except corrugated steel pipe may be used. See limitations, Wis. Adm. Code section H 62.19.

(b) *Size.* The building storm sewer shall be sized as required in Wis. Adm. Code section H 62.04 (3) (b).

(3) **STORM BUILDING DRAINS.** (a) *Materials and installation.* Materials and installation of storm drains shall be as specified for sanitary building drains.

(b) *Size.* The building storm drain shall be sized as required in Wis. Adm. Code section H 62.05 (3) (b).

Table 11
SIZE OF HORIZONTAL STORM DRAINS ACCORDING
TO ROOF AREA SERVED

Pipe Size	Pitch $\frac{1}{16}$ " per 1' sq. ft. area	Pitch $\frac{1}{8}$ " per 1' sq. ft. area	Pitch $\frac{1}{4}$ " per 1' sq. ft. area	Pitch $\frac{1}{2}$ " per 1' sq. ft. area
3"-----	650	910	1,300	1,820
4"-----	1,300	1,950	2,900	3,770
5"-----	2,470	3,640	5,070	7,020
6"-----	4,160	5,980	8,320	11,700
8"-----	9,320	13,000	18,200	26,000
10"-----	17,630	24,700	33,800	50,440
12"-----	27,300	41,030	57,200	81,900
15"-----	52,000	72,800	105,300	146,640
18"-----	85,800	121,550	174,200	247,000
21"-----	156,620	179,660	256,880	374,400
24"-----	187,200	261,560	382,200	546,000

Table 11a

**MINIMUM SIZE OF HORIZONTAL STORM DRAINS SERVING
PAVED OR GRAVELED GROUND SURFACE AREAS**

Pipe Size	Pitch $\frac{1}{16}$ " per 1' sq. ft. area	Pitch $\frac{1}{8}$ " per 1' sq. ft. area	Pitch $\frac{1}{4}$ " per 1' sq. ft. area	Pitch $\frac{1}{2}$ " per 1' sq. ft. area
3"-----	810	1,140	1,625	2,270
4"-----	1,625	2,480	3,740	4,720
5"-----	3,090	4,550	6,350	8,760
6"-----	5,200	7,470	10,400	14,600
8"-----	11,650	16,250	22,750	32,600
10"-----	22,100	30,850	44,250	63,000
12"-----	34,150	52,800	71,500	102,200
15"-----	65,000	91,000	131,500	183,000
18"-----	107,000	152,000	210,800	321,000
21"-----	195,000	224,000	321,000	468,000
24"-----	234,000	386,000	478,000	682,000

Table 11b

**MINIMUM SIZE OF HORIZONTAL STORM DRAINS SERVING
LAWNS, PARKS AND SIMILAR LAND SURFACES**

Pipe Size	Pitch $\frac{1}{16}$ " per 1' sq. ft. area	Pitch $\frac{1}{8}$ " per 1' sq. ft. area	Pitch $\frac{1}{4}$ " per 1' sq. ft. area	Pitch $\frac{1}{2}$ " per 1' sq. ft. area
3"-----	2,600	3,640	5,200	7,280
4"-----	5,200	7,800	11,960	15,080
5"-----	9,880	13,560	20,280	28,080
6"-----	16,640	23,920	33,280	46,800
8"-----	37,280	52,000	72,800	112,000
10"-----	69,720	98,800	135,200	201,760
12"-----	109,200	154,320	228,800	327,600
15"-----	208,000	291,200	421,200	586,560
18"-----	343,200	490,200	596,800	983,000
21"-----	326,080	718,640	1,027,520	1,497,500
24"-----	748,800	1,046,240	1,523,800	2,184,000

(c) *Other clear water wastes.* Where there is a continuous or semi-continuous discharge into the building storm drain, such as refrigerator cooling water, compressor cooling water, drinking fountains, ornamental ponds and other clear water drains not described herein, each gallon per minute of discharge shall be computed as 26 square feet of roof area. Table 12 may be used for sizing clear water drains other than storm water drains.

Table 12

APPROXIMATE CAPACITY OF HORIZONTAL DRAINS

Pipe Size	Pitch $\frac{1}{16}$ " per 1' GPM	Pitch $\frac{1}{8}$ " per 1' GPM	Pitch $\frac{1}{4}$ " per 1' GPM	Pitch $\frac{1}{2}$ " per 1' GPM
3"-----	25	95	50	70
4"-----	50	75	115	145
5"-----	95	140	195	270
6"-----	160	230	320	450
8"-----	355	500	700	1,000
10"-----	680	950	1,300	1,940
12"-----	1,050	1,580	2,200	3,150
15"-----	2,000	2,800	4,050	5,640
18"-----	3,300	4,675	6,700	9,500
21"-----	6,020	8,910	9,880	14,400
24"-----	7,200	10,060	14,700	21,000

(d) *Backflow valves.* Building storm drains subject to backflow or backwater at the time of installation shall be provided with adequate backwater valves, installed to prevent interference with the flow and be readily accessible.

(4) **AREA DRAINS.** (a) *Window well drains.* All window well areas not exceeding 50 square feet shall be properly drained. This area drain may discharge to a subsoil or foundation drain through a minimum 2 inch diameter pipe or to the building storm drain. The drain inlet should be provided with a strainer.

(b) *Area drains.* An area drain shall be provided for open sub-surface spaces 50 square feet or more in area. The drain shall discharge to the building storm drain, storm subdrain or storm sewer. If no storm sewer exists, the discharge shall be as specified in section H 62.12 (1) (b). The area drain shall have a minimum inside diameter of 2 inches and shall not discharge into a subsoil, footing or foundation drain.

(5) **RAINWATER CONNECTIONS.** (a) All roof conductors placed within a building, interior court, ventilating pipe or shaft shall be installed as specified for soil, waste and vent pipes except black iron or steel pipe may be used. Black iron or steel roof conductors shall not be embedded in masonry or concrete.

(b) When rainwater conductors installed outside a building discharge to a storm sewer or drain, the horizontal portion extending 2 feet inside the exterior wall and the vertical portion outside the wall shall terminate with the hub above grade and shall be made of cast iron pipe.

(c) *Roof drains.* Roof drains shall be made of cast iron, copper, lead or other material approved by the department.

1. Storm water inlets for use on sun decks, parking decks, surface areas and similar areas may be of the flat surface type and shall have an available inlet area of not less than 2 times the required area of the conductor.

2. Roof drains, other than those specified in section H 62.12 (5) (c) 1., shall be equipped with strainers extending not less than 4 inches above the surface of the roof immediately adjacent to the roof drain. Strainers shall have an available inlet area, above the roof, of not less than $1\frac{1}{2}$ times the area of the conductor to which the drains connect.

(6) **TRAPS FOR STORM AND CLEAR WATER WASTES.** (a) Traps shall not be required for storm water conductors when the conductors extend to the roof of a building unless the drain inlet is within 8 feet of a door or openable window or within 20 feet of a fresh air inlet.

(b) Area drains will not require a trap unless such drain inlet is within 8 feet of a door, openable window or 20 feet from a fresh air intake. One or more drain inlets may be connected to a single trap which shall be located immediately inside the building.

(c) Footing, foundation and subsoil drains shall discharge into a trap or trapped drain tile receiver and be provided with a clean-out. A trap is not required when footing, foundation and subsoil drains discharge to a sump and pump which elevate the waste.

(d) Traps are required at all interior drain inlets receiving clear water wastes.

(e) Inlets of drains receiving clear water wastes shall terminate wherever possible at least 2 inches above the floor but in no case less than 1 inch.

(7) **VENTS REQUIRED.** (a) A trap receiving clear water wastes shall be supplied with a properly installed vent. Such vent or vents shall not connect to the sanitary plumbing system.

(b) Vents shall not be required for traps which receive storm water wastes exclusively.

(8) **CLEANOUTS.** (a) *Size.* Cleanouts shall conform to Wis. Adm. Code section H 62.10 (5) and (7).

(b) *Storm drain.* A cleanout with a brass screw cover or other type approved by the department shall be provided at a point where the drain leaves the building. This cleanout shall be extended from the building drain with cast iron soil pipe to the surface of the finished floor or grade and wherever practical shall be not less than 2 inches above the finished floor or grade. An additional cleanout located 28 to 30 inches above the floor shall be provided in all roof conductors. Cleanouts will not be required in roof conductors in a one story building provided the roof conductor does not exceed 25 feet in length and does not have an offset greater than 45° from the vertical.

(c) *Storm drain branches.* Cleanouts shall be provided in all storm drain branches exceeding 25 feet in length.

(d) *Storm sewer access.* Building storm sewer cleanouts shall be installed as required in Wis. Adm. Code section H 62.04 (4) (h).

(9) **PROHIBITED CONNECTIONS.** Rainwater conductors shall not be used as soil, waste or vent pipes; nor shall any soil, waste or vent pipes or clear water waste piping be used as rainwater conductors.

History: Cr. Register, November, 1972, No. 203, eff. 12-1-72.

H 62.13 Water distribution systems. (1) **GENERAL REQUIREMENTS.** Every building equipped with plumbing fixtures and used for human occupancy or habitation shall be provided with a potable supply of cold water. In residences and buildings serving the public and places of employment, hot water shall be provided.

(2) **WATER SERVICES.** (a) *Size.* The water service pipe shall be of sufficient size to furnish water to the building in the quantities and at the pressures required in section H 62.13 (4) (d) and (h) 3. The minimum inside diameter of the service pipe shall be $\frac{3}{4}$ inch. Methods for sizing the water service are described in section H 62.13 (4) (d), table 13.

(b) *Materials.* The water service to any building shall be type K copper, lead, brass, cast iron water pipe, galvanized wrought iron, galvanized open hearth iron, galvanized steel, plastic, asbestos cement or other materials approved by the department. Any of the above materials used shall be acceptable to the local or municipal water utility.

(c) *Valve controls.* Service controls shall include a valve or shut-off at the main, curb or private water supply system and inside the foundation wall of each building and on the building side of the water meter of each building.

1. Curb stop. A curb stop shall be an approved gate valve or ground key stopcock or ball valve which shall be installed between the property line and curb. The valve or stopcock shall be provided with an approved curb valve box. One valve may serve as the shut-off at the main and curb stop for water services 3 inches and larger. See following sketch.

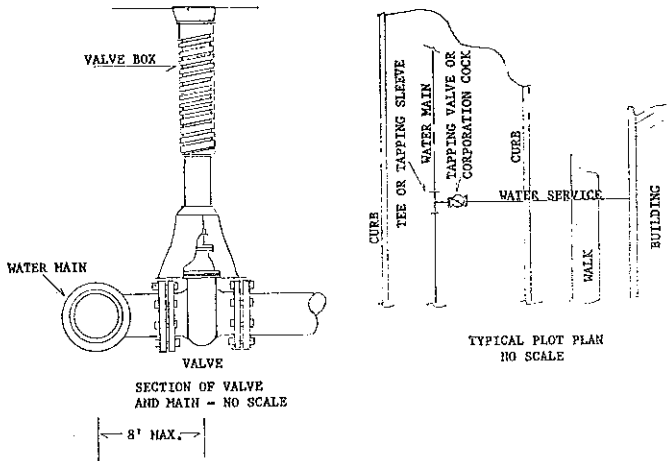

2. Stop and waste valves prohibited. Combination stop and waste valves shall not be installed underground in water service piping. Frostproof yard hydrants shall be approved by the department.

3. Building valves. Each water supply service shall be provided with a gate valve or other full way valve, one to be located inside the building near the point where the water service enters and the other on the water distribution side of the meter. A bypass valve shall be provided for all 2 inch or larger water meters. The bypass shall be no smaller than one nominal pipe size of the water meter. When parallel meters are installed, a bypass shall not be required provided the other meter(s) adequately serve the building water distribution requirements.

(d) *Separation of water service and building sewers.* 1. Except as permitted below, the underground water service pipe and building sewer shall not be less than 10 feet apart horizontally and shall be separated by undisturbed or compacted earth. The water service pipe may be placed in the same trench with the building sewer under the following conditions:

- a. The water service and the building sewer are installed concurrently.
- b. The bottom of the water service pipe at all points shall be at least 12 inches above the top of the sewer line.
- c. The water service pipe shall be placed on the solid shelf excavated at one side of the common trench.
- d. The number of joints in the water service pipe shall be kept to a minimum.
- e. The materials and joints of water service pipe shall be installed in such a manner and shall possess the necessary strength and dura-

bility to prevent the escape of liquids and gases therefrom, under all known adverse conditions such as corrosion, strain due to temperature changes, settlement, vibrations and super imposed loads.

2. Where the building sewer is existing, the water service pipe shall be installed in a separated trench pursuant to section H 62.13 (2) (d) 1., excepting a replaced water service may be installed pursuant to section H 62.13 (2) (d) 1. b. and c.

(e) *Water service pipe through walls.* 1. Clearance shall be provided around a water service pipe passing through walls to protect it against:

a. Chemical action from direct contact with concrete.

b. Distortion or rupture of water service piping from shearing action due to settlement.

c. Distortion or rupture of water service pipe caused by expansion or contraction.

2. Clearance shall not be less than $\frac{1}{2}$ inch between the outside of the pipe and the wall. Sleeves or arches may be used to provide the wall opening. The space between the pipe and wall structure shall be carefully packed or caulked with lead or waterproof, vermin and rodent resistant material.

(3) **FIXTURE SUPPLY.** (a) *Potable water.* Only potable water shall be permitted to serve plumbing fixtures for drinking, bathing, culinary use or the processing of food, medical or pharmaceutical products.

(b) *Identification.* 1. Where 2 or more distribution systems are installed, each system shall be identified either by color marking, metal tags or other methods as may be approved by the department.

a. *Color marking.* When color marking is used, potable water lines should be painted green and non-potable water lines should be painted yellow. This requirement may be met by painting 3 inch wide bands at intervals of not more than 25 feet and at points where piping passes through walls, floors, or roofs in which case the bands shall be applied to the piping on both sides of the walls and both above and below the floor or roof. Points of outlets for non-potable water shall be marked with a tag or color coded.

b. *Metal tags.* When tags are used, potable water lines shall be identified by 3 inch diameter metal tags bearing the legend **SAFE WATER** in letters not less than $\frac{1}{2}$ inch in height. Non-potable water lines shall be identified by firmly attached metal tags having the shape of a 4 inch equilateral triangle bearing the legend **WATER UNSAFE** in letters not less than $\frac{7}{16}$ inch in height. As in the use of color bands, tags shall be attached to pipes at intervals of not more than 25 feet and at either side of points where pipes pass through walls and above and below points where pipes pass through floors or roofs.

(4) **BUILDING DISTRIBUTION SYSTEMS.** (a) *Design.* Water piping systems shall be designed and installed so that the maximum velocity at any time shall not exceed 8 feet per second.

(b) *Materials.* All water distribution pipes within a building shall be of lead, galvanized wrought iron, galvanized steel, brass, or cast iron, with brass or galvanized malleable iron fittings, type K or L copper water tube with copper or brass fittings or other materials approved by the department. Copper water tube used underground

shall be type K. No pipe or fittings that have been used for other purposes shall be used for distributing potable water.

(c) *Supports.* All piping shall be supported to prevent undue strains upon connections or fixtures and shall be so aligned and graded that the entire system or parts thereof can be controlled and drained. The formation of traps or sags in water piping shall be avoided where possible. When unavoidable such sags, traps or inverts shall have provisions for properly draining same.

(d) *Supply demand.* The supply demand in gallons per minute in the building water distribution system shall be determined on the basis of the load in terms of supply fixture units and of the relationship between load and supply demand as shown in tables 13 and 14.

Table 13
SIZING THE WATER DISTRIBUTION SYSTEM

Fixture	Occupancy	Type of Supply Control	Load in Fixture Supply Units
Bathroom group.....	Private	Flush valve for closet	8
Bathroom group.....	Private	Flush tank for closet	6
Bath tub.....	Private	Faucet	2
Bath tub.....	Public	Faucet	4
Clothes washer.....	Private	Faucet	2
Clothes washer.....	Public	Faucet	4
Combination fixture.....	Private	Faucet	3
Kitchen sink.....	Private	Faucet	2
Kitchen sink.....	Hotel, restaurant	Faucet	4
Laundry trays (1 to 3).....	Private	Faucet	3
Lavatory.....	Private	Faucet	1
Lavatory.....	Public	Faucet	2
Separate shower.....	Private	Mixing valve	2
Service sink.....	Office, etc.	Faucet	3
Shower head.....	Private	Mixing valve	2
Shower head.....	Public	Mixing valve	4
Urinal—stall or wall.....	Public	Flush valve	5
Urinal—stall or wall.....	Public	Flush tank	3
Water closet.....	Private	Flush valve	6
Water closet.....	Private	Flush tank	3
Water closet.....	Public	Flush valve	10
Water closet.....	Public	Flush tank	5

Water supply outlets for items not listed above shall be computed at their maximum demand, but in no case less than:

Fixture	Number of Fixture Units	
	Private Use	Public Use
$\frac{3}{8}$ inch.....	1	2
$\frac{1}{2}$ inch.....	2	4
$\frac{3}{4}$ inch.....	3	6
1 inch.....	6	10

1. For supply outlets likely to impose continuous demands, estimate continuous supply separately and add to total demand for fixtures.

2. The given weights are for total demand. For fixtures with both hot and cold water supplies, the weights for maximum separate demands may be taken as $\frac{3}{4}$ the listed demand for the supply.

3. Compute flush valve demand separately.

Table 14
ESTIMATING DEMAND

Supply Systems Predominantly For Flush Tanks		Supply Systems Predominantly For Flush Valves	
Load (Water Supply Fixture Units)	Demand GPM	Load (Water Supply Fixture Units)	Demand GPM
6	5		
8	6.5		
10	8	10	27
12	9.2	12	28.6
14	10.4	14	30.2
16	11.6	16	31.8
18	12.8	18	33.4
20	14	20	35
25	17	25	38
30	20	30	41
35	22.5	35	43.8
40	24.3	40	46.5
45	27	45	49.5
50	29	50	51.5
60	32	60	55
70	35	70	58.5
80	38	80	62
90	41	90	64.8
100	43.5	100	67.5
120	48	120	72.5
140	52.5	140	77.5
160	57	160	82.5
180	61	180	87
200	65	200	91.5
225	70	225	97
250	75	250	101
275	80	275	105.5
300	85	300	110
400	105	400	126
500	125	500	142
750	170	750	178
1,000	208	1,000	208
1,250	240	1,250	240
1,500	267	1,500	267
1,750	294	1,750	294
2,000	321	2,000	321
2,250	348	2,250	348
2,500	375	2,500	375
2,750	402	2,750	402
3,000	432	3,000	432
4,000	525	4,000	525
5,000	598	5,000	598
6,000	643	6,000	643
7,000	685	7,000	685
8,000	718	8,000	718
9,000	745	9,000	745
10,000	769	10,000	769

(e) *Variable street pressures.* Where street water main pressures fluctuate, the building water distribution system shall be designed for the minimum pressure available.

(f) *Excessive pressures.* When street main pressures exceed 80 pounds per square inch (p.s.i.), an approved pressure reducing valve shall be installed in the water distribution system where the water service enters the building to reduce the water pressure to 80 p.s.i. or lower except where the water service pipe supplies water directly to a water pressure booster system, elevated water gravity tank or to pumps provided in connection with a hydropneumatic or elevated gravity water supply tank system. Pressure at any fixture shall be limited to no more than 80 p.s.i. under no flow conditions.

(g) *Inadequate water pressure.* Whenever water pressure from the street main or other sources of supply is insufficient to provide flow pressures at fixture outlets as required, a booster pump and pressure tank or other approved means shall be installed in the building water supply system.

(h) *Size.* 1. The diameter of any pipe serving more than one plumbing fixture or appliance shall not be less than $\frac{3}{4}$ inch inside diameter.

2. The minimum size of a fixture supply pipe shall be as shown in table 15. The fixture supply pipe shall be extended to within at least 18 inches of the point of connection to the fixture.

Table 15
MINIMUM SIZES OF FIXTURE WATER SUPPLY PIPES

Type of Fixture or Device	I. D. Pipe Size (Inches)	Type of Fixture or Device	I. D. Pipe Size (Inches)
Bathtubs.....	$\frac{1}{2}$	Shower (single head).....	$\frac{1}{2}$
Combination sink and tray.....	$\frac{3}{8}$	Sinks (service, slop).....	$\frac{1}{2}$
Drinking fountain.....	$\frac{3}{8}$	Sinks (flushing rim).....	$\frac{3}{4}$
Dishwasher (domestic).....	$\frac{1}{2}$	Urinal (flush tank).....	$\frac{3}{4}$
Electric drinking water cooler.....	$\frac{3}{8}$	Urinal (direct flush valve).....	$\frac{3}{4}$
Kitchen sink, residential.....	$\frac{1}{2}$	Water closet (tank type).....	$\frac{3}{8}$
Kitchen sink, commercial.....	$\frac{3}{4}$	Water closet (flush valve type).....	1
Lavatory.....	$\frac{3}{8}$	Hose bibbs.....	$\frac{1}{2}$
Laundry tray 1, 2 or 3 compartments.....	$\frac{1}{2}$	Wall hydrant.....	$\frac{1}{2}$

3. Based on the minimum hydrostatic pressure available, pipe sizes shall be selected so that under conditions of peak demand a minimum flow pressure at the point of discharge shall be not less than required to maintain minimum flow rates listed in table 16. Pipe sizes for flush valve water closets and urinals shall be adequate to maintain flow pressures of 25 pounds per square inch for blowout action and 20 pounds per square inch for jet action fixtures.

Table 16
MINIMUM FLOW RATES PER OUTLET

Fixture	Flow Rate Minimum GPM
Lavatory.....	2
Sink.....	4
Bathtub.....	6
Laundry tray.....	5
Shower.....	8
Water closets	
Tank type.....	8
Blowout action.....	Depends on flow pressure
Jet action.....	Depends on flow pressure
Drinking fountain.....	0.75
Wall hydrant.....	6

(i) *Hot water distribution.* 1. Hot water supply system. In residences, buildings serving the public and places of employment, hot water shall be supplied to all plumbing fixtures and equipment used for bathing, washing, culinary purposes, cleansing, laundry or building maintenance.

2. Water temperature control. Temperature of mixed water to multiple or gang showers shall be controlled by a master thermostatic blender or such showers may be individually regulated by balance pressure mixing valves. Individual showers in commercial and public buildings subject to rapid rise of mixed water temperature due to system pressure fluctuation shall have balance pressure mixing valves in addition to flow regulation as indicated in table 16.

3. Return circulation where required. Hot water supply risers in buildings 5 or more stories in height or in buildings where developed length of hot water piping from the source of the hot water supply to the farthest fixture exceeds 100 feet, shall be of the return circulation type and no uncirculated branch line shall exceed 25 feet in length. Valves shall be provided on the inlet and outlet of the return circulation pump.

4. Minimum requirements for hot water storage tanks. Hot water storage tanks shall be adequate in size when combined with the B.T.U. input of the water heating equipment to provide the necessary rise in temperature. The water heater and storage tank shall be sized to provide sufficient hot water to provide both daily requirements and hourly peak loads for the occupants of the building. Hot water storage tanks shall meet the construction requirements of A.S.M.E., A.N.S.I., or U.L. as appropriate. Storage tanks less in volume than those requirements specified by A.S.M.E., shall be of durable materials and constructed to withstand 125 p.s.i. with a safety factor of 2. The size of the water inlets and outlets of the hot water storage tank shall be not less than the hot water distribution pipe served or adjacent manifold piping. All storage tanks shall be protected against excessive temperature and pressure conditions as specified in this code.

5. Hot water storage tank drain valves. a. Location. A drain valve shall be installed at the lowest point of each hot water storage tank and be readily accessible.

b. The drain valve shall be hand operable without the use of tools.

c. The drain valve inlet shall be a minimum $\frac{3}{4}$ inch nominal iron pipe size and the outlet end shall be equipped with a minimum standard $\frac{3}{4}$ inch male hose thread.

6. Safety devices. a. Pressure relief valves, temperature relief valves and energy cut-off devices required. Equipment used for heating water or storing hot water shall be protected by approved safety devices in accordance with one of the following methods:

1. A separate pressure relief valve and separate temperature relief valve.

2. A combination pressure and temperature relief valve.

3. A combination of either 1. or 2. above and an energy cut-off device.

b. Safety devices shall meet the requirements of the A.S.M.E. or U.L. Listing by U.L., A.G.A. or National Board of Boiler and Pressure Vessel Inspectors shall constitute evidence as conformance with these standards. Where a device is not listed by any of these, it must have certification by a recognized laboratory as having complied with these requirements.

(j) *Pressure relief valves.* Pressure relief valves shall meet the A.S.M.E. standards. The valves shall have a relief rating adequate

to meet the pressure conditions in the equipment served. They shall be installed either directly in a top tank tapping or in the hot water outlet line close to the tank. There shall be no shut-off valve between the pressure relief valve and the tank. The pressure relief valve must be set to open at not less than 25 p.s.i. above the street main pressure or not less than 25 p.s.i. above the setting of any building water pressure regulating valve. The setting shall not exceed the tank rated working pressure.

(k) *Temperature relief valves.* Temperature relief valves shall be of adequate relief rating expressed in B.T.U./H.R. for the equipment served. They shall be installed so that the temperature sensing element is immersed within the top 6 inches of the tank. The valve shall be set to open when the stored water temperature is 210° F. (or less).

(l) *Combination pressure temperature relief valves.* Combination pressure temperature relief valves shall comply with all the requirements of the separate pressure and temperature relief valves.

(m) *Energy cut-off devices.* Energy cut-off devices shall be of adequate performance rating for the equipment served. Immersion type energy cut-off devices shall be located so that the temperature sensing element is immersed in the water within the tank and controls the temperature of the water within the top 6 inches of the tank. When approved by the department, contact types shall be installed so that the sensing element is responsive to the highest water temperature within the equipment served and is securely fastened in place. When an energy cut-off device is used, it shall be factory applied by the heater manufacturer and comply fully with the appropriate standards of A.N.S.I. or U.L. They shall be installed in a manner that will isolate them from ambient flue gas temperatures and other conditions not indicative of the temperature of the water within the heater.

(n) *Installation of relief valves.* Every relief valve shall have a discharge pipe the same size as the outlet drain on the relief valve which shall terminate not more than 10 inches above the floor as close as possible to a drain properly connected to the building drain or sewer. Such discharge pipe shall be galvanized wrought iron or steel, copper or brass, installed with approved fittings. The relief valve discharge pipe shall be pointed and drained downward in such a manner to allow the drain and discharge pipe to drain dry. The base or end of such discharge pipe shall not be threaded. No discharge pipe shall terminate into an open fixture such as a sink, laundry tub, bathtub, or supply tank, etc., or installed in a freezing area. No check valve or shut-off valve shall be installed between any safety device and the hot water equipment used, nor shall there be any shut-off valves in the discharge pipe from the relief valve.

(o) *Vacuum relief valves.* Where a hot water storage tank or an indirect water heater is located at an elevation above the fixture outlets in the hot water system, a vacuum relief valve shall be installed on the storage tank or heater.

(p) *Pressure marking of hot water storage tank.* Hot water storage tanks shall be permanently marked in an accessible place with the maximum allowable working pressure.

(q) *Water hammer suppressors.* 1. Water hammer suppressors. All water supply systems, water distribution systems and components

connected thereto, shall be provided with approved shock absorbing devices located and sized to suppress water hammer.

2. Air chamber. Water supply risers of three or more floors shall terminate with an air chamber. Water supply pipes serving fixtures, appliances, equipment, devices and appurtenances shall terminate with an air chamber. For 3/8 and 1/2 inch inside diameter pipe, the air chamber shall be 1/2 inch X 1 inch X 14 inches. For 3/4 inch inside diameter pipe, the air chamber shall be 1/2 inch X 1 1/2 inches X 18 inches. For 1 inch inside diameter pipe the air chamber shall be 3/4 inch X 1 1/2 inches X 30 inches or 3/4 inch X 2 inches X 18 inches. For pipe sizes greater than 1 inch inside diameter, the volume, length and diameter of the air chamber shall be in accord with the hydraulic design of the piping system served and the connection shall be one nominal inside diameter smaller than the pipe served. Excessively high air chambers should not be used. For the purpose of this rule, the length of an air chamber will be determined by measuring from the bottom of the restriction to the top of the air chamber with the length of the restricted portion no greater than 1 1/2 inches.

3. Mechanical suppressor. Approved mechanical water hammer suppressors may be installed in lieu of air chambers. The size and location of the suppressors shall be in accord with the hydraulic design of the piping system served. All mechanical water hammer suppressors shall be accessible.

(r) Water distribution control valves. 1. Single family dwellings. Controls within a single family dwelling unit shall include a valve for each lawn sprinkler faucet, water heater, water closet, point of entrance of the water service, discharge side of the water meter and each appliance or appurtenance.

2. Multiple dwellings and public buildings. a. In dwellings other than single family, one or more control valves shall be provided so that the water to any one plumbing fixture or group of fixtures may be shut off without stopping flow of water to fixtures in other dwelling units. Four or less dwelling units may be served with one branch control valve provided each dwelling unit is valved or each individual fixture is valved. All water closets, lawn sprinkler faucets, appliances, wall hydrants and kitchen sinks shall be valved in dwelling units. See following sketch.

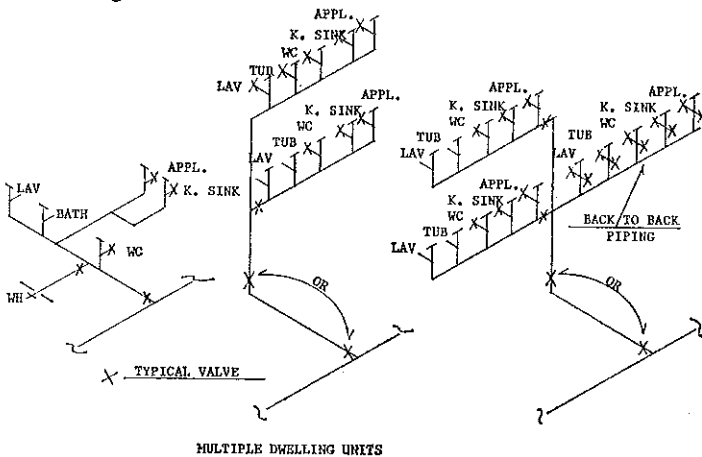

MULTIPLE DWELLING UNITS

1 UNIT

2 UNITS

4 UNITS

b. In all public buildings other than dwelling units, each hot and cold water main, main branch, branch serving a group of fixtures and a branch exceeding 10 feet in length serving a single fixture shall be valved. All fixtures, appliances, appurtenances, lawn sprinkler faucets and wall hydrants in a public building shall be valved. See following sketch.

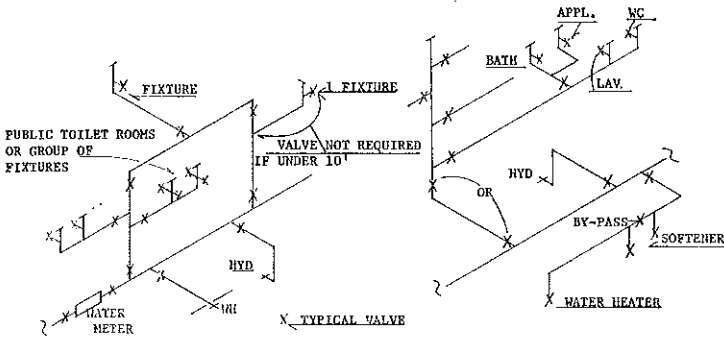

c. Riser valves. A valve shall be installed at the foot of each water supply riser or in the branch serving a single riser. In multiple story buildings, a valve shall be installed at the top of each water supply down feed pipe and also at the base where required to isolate this riser for servicing. See Wis. Adm. Code section H 62.15 (10) (b). See following sketch.

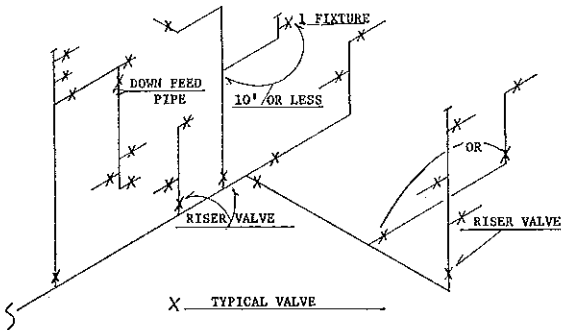

d. Water heating equipment valve. The cold water branch to each hot water storage tank or water heater shall be provided with a valve located in the same room near the equipment and serving only this equipment. Each tank or heater shall be equipped with an approved safety relief valve as specified in section H 62.13.

e. Softener bypass. All commercial water softeners shall be provided with a bypass.

f. Valves to be accessible. All water supply control valves shall be placed so as to be accessible for service and maintenance.

g. Control valve design. Control valves on all water lines shall, when fully opened, have a cross-sectional area not less than 85% of the cross-sectional area of the line in which they are installed. Fix-

ture supply valves shall have a cross-sectional area large enough to provide the supply demand in accord with section H 62.13 (4).

h. Tank controls. Supply lines from pressure or gravity tanks shall be valved in the same room at or near the tanks.

i. Hospital and nursing home valving requirements. See Wis. Adm. Code section H 62.15 (10) (b).

(5) WATER PRESSURE BOOSTER SYSTEMS. (a) *Where required.* When the water pressure in the public water main or individual water supply system is insufficient to supply the probable peak demand flow to all plumbing fixtures and other water needs freely and continuously within the minimum pressures and quantities specified in section H 62.13 (4) (d) and (h) 3. or elsewhere in this section and in accordance with good practice, the rate of supply shall be supplemented by an elevated water tank, a hydropneumatic pressure booster system, or a water pressure booster pump.

(b) *Overflows for water supply tanks.* Each gravity or unpressurized water supply tank shall be provided with an overflow having a diameter not less than shown in table 17. The overflow outlet shall discharge above and within 6 inches of a roof drain or site drain which terminates in a storm sewer. The overflow outlet shall be covered by a corrosion resistant screen of not less than 16 × 20 mesh to the inch and by ¼ inch hardware cloth or shall terminate in a horizontal angle seat check valve. Drainage from overflow pipes shall be directed so as not to freeze on roof walkways.

Table 17
SIZES FOR OVERFLOW PIPES FOR WATER SUPPLY TANKS

Maximum Capacity of Water Supply Line of Tank	Diameter of Overflow Pipe (Inches I. D.)	Maximum Capacity of Water Supply Line to Tank	Diameter of Overflow Pipe (Inches I. D.)
0- 13 gpm-----	1½	166- 355 gpm-----	4
14- 55 gpm-----	2	356- 640 gpm-----	5
56-100 gpm-----	2½	641-1040 gpm-----	6
101-165 gpm-----	3	over 1040 gpm-----	8

(c) *Covers.* All gravity and unpressurized water supply tanks shall have a locked overlapping cover. The covers of these tanks shall be vented with a return bend vent pipe having an area not less than the area of the down feed riser pipe and the vent shall be screened with corrosion resistant screening having not less than 14 and not more than 20 openings per linear inch.

(d) *Potable water inlet control and location.* Potable water inlets to gravity and unpressurized tanks shall be controlled by an automatic supply valve so installed as to prevent the tank from overflowing. The inlet shall be terminated so as to provide an approved air-gap, but in no case less than 6 inches above the overflow.

(e) *Tank drain pipes.* Each tank shall be provided at its lowest point with a valved pipe to permit emptying the tank which shall discharge as required for overflow pipes and not smaller in size than shown in table 18.

Table 18
SIZE OF DRAIN PIPES FOR WATER TANKS

Tank Capacity (gallons)	Drain Pipe (inches)	Tank Capacity (gallons)	Drain Pipe (inches)
Up to 750.....	1	3001 to 5000.....	2½
751 to 1500.....	1½	5001 to 7500.....	3
1501 to 3000.....	2	over 7500.....	4

(f) *Low pressure cut-off required on booster pumps.* When a booster pump is used on a water pressure booster system, there shall be installed a low pressure cut-off on the booster pump to prevent the creation of a vacuum or negative pressure on the suction side of the pump, thus cutting off water to other outlets.

(g) *Pressure tanks, vacuum relief.* All water pressure tanks shall be provided with a vacuum relief valve at the top of the tank which will operate up to a maximum water pressure of 200 p.s.i. and to maximum water temperature of 200° F. The minimum size of such vacuum relief valves shall be ½ inch.

(6) **DISINFECTION OF POTABLE WATER SYSTEM.** (a) *Procedure.* New or repaired potable water systems shall be disinfected prior to use. The method to be followed shall be as follows.

1. The pipe system shall be flushed with clean, potable water until no dirty water appears at the points of outlet.

2. The system or part thereof shall be filled with a water chlorine solution containing at least 50 parts per million of chlorine and the system or part thereof shall be valved off and allowed to stand for 24 hours or the system or part thereof shall be filled with a water chlorine solution containing at least 200 parts per million of chlorine and allowed to stand for 3 hours.

3. Following the allowed standing time, the system shall be flushed with clean potable water until no chlorine remains in the water coming from the system.

4. The procedures shall be repeated if it is shown by a bacteriological examination that contamination still exists in the system.

(7) **SPECIAL EQUIPMENT.** (a) *Separate piping for each source.* A water supply that meets accepted standards for purity for human consumption shall be distributed through a piping system entirely independent of any piping system conveying another water supply.

(b) *Piping by plumber.* Only persons licensed by the department as master or journeyman plumbers shall install water supply piping to any system designed for steam power, heating, temperature regulation, automatic fire protection, air-conditioning, comfort cooling, process piping, hydraulic power or for any special water usage for industrial or manufacturing purposes. All such piping for supplying water for any of the above listed uses shall be brought by the licensed plumber to a point within the building or structure and within 10 feet of the point of entry to any of the above systems where it shall terminate with an air-gap or other method approved by the department.

(c) *Piping by equipment installers.* Connection of systems specified in section H 62.13 (7) (b) to the water supply pipe and the discharge

therefrom through an air-gap into a trap, fixture, receptacle or interceptor installed by the licensed plumber, as prescribed by rules and regulations, may be made by the person installing such systems.

History: 1-2-56; r. and rec. Register, November, 1972, No. 203, eff. 12-1-72.

H 62.14 Back-siphonage, cross-connections and potability control.

(1) **PROTECTION OF POTABLE WATER SUPPLY.** (a) *General.* Potable water supply systems shall be designed, installed and maintained in such manner as to prevent contamination from non-potable liquids, solids or gases from being introduced into the potable water supply through cross-connections or any other piping connections to the system.

(b) *Interconnections.* Interconnections of water services between 2 or more public water systems, water distribution systems, or a private and public supply shall be permitted only with approval of the department.

(c) *Cross-connection control.* Cross-connections are prohibited except as approved by the department when suitable protective devices such as the reduced pressure zone backflow preventer or equal are installed, tested and maintained to insure proper operation on a continuing basis.

(d) *Water treatment.* All water treatment compounds approved by the department for introduction into the potable water distribution system shall be by a positive displacement pump.

(e) *Painting of water tanks.* The interior surface of the potable water tank shall not be lined, coated, painted or repaired with any material which will affect either the taste, odor, color or potability of the water supply when the tank is placed in or returned to service.

(f) *Used piping.* Piping which has been used for any other purpose than conveying potable water shall not be used for conveying potable water.

(g) *Water supply to boilers.* Potable water supply to boilers or boiler feed water systems shall be through an air-gap or approved backflow preventer.

(h) *Prohibited connections to fixtures and equipment.* Connection to the potable water supply system for the following shall be protected against backflow or back-siphonage.

1. Operating, dissection, embalming and mortuary tables or similar equipment. In such installations the hose used for water supply shall terminate at least 12 inches away from every point of the table or attachments. See following sketch.

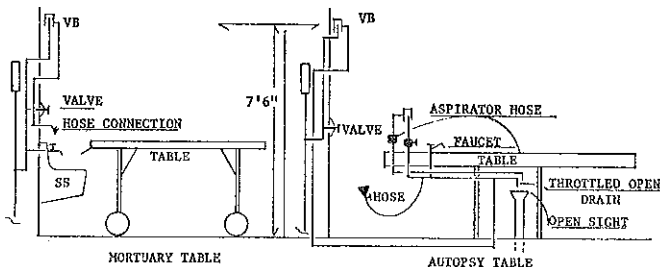

2. No closet bowl or other fixture equipped with a flushometer valve or with flushing tanks shall be installed with a side or rear spud located below the lower part of the flush rim of the bowl.
3. Seat acting water closets.
4. Bedpan washers.
5. Bidets.
6. Sterilizers with water supply connections.
7. Therapeutic baths with inlets below the rim of the fixture.
8. Water operated waste ejectors.
9. Bathtubs with inlets below the rim of the fixture.
10. Wash basins with inlets below the rim of the fixture.
11. Bar, soda fountain or other sinks with submerged inlets.
12. Laundry trays with faucets below the rim.
13. Sinks with faucets or water inlets below the rim and sinks with loose hose connections.
14. Dishwashing sinks or machines with water inlets below the rim.
15. Cuspidors with water supply connections.
16. Dental cuspidors with water supply connections.
17. Hospital appliances. See Wis. Adm. Code section H 62.15.
18. Frostproof hydrants with underground bleed or an automatic livestock water device.
19. Industrial vats, tanks, etc., of a description which have an inverted water supply connection or a water supply connection below the top of the spill rim or in which a hose filler is used.
20. Industrial water supplied process appliance with direct water connections.
21. A rubber hose with hand control or self-closing faucets attached as used in connection with baths, industrial vats, canneries, etc.
22. Pressure water supplied sealing rings on sewage and sludge pumps.
23. Water supply for priming connections.
24. Water supply (hot or cold) to laundry equipment.
25. Condenser cooling connections for refrigeration and air-conditioning machinery.
26. Drains from fire sprinklers connected direct to sewer or waste.
27. Steam tables.
28. Condensers.
29. Stills.
30. Aspirators.
31. Chlorinators.
32. Photographic developing tanks.
33. Fixture inlets or valve outlets with hose attachments which may constitute a cross-connection shall be protected by an approved vacuum breaker installed at least 6 inches above the highest point of usage and located on the discharge side of the last valve. Manufactured fixtures with integral vacuum breakers shall be approved by the department.
34. Laboratory water faucets and cocks with serrated nipples or hose connections.
35. Lawn sprinkling faucets.
36. Any other fixture or installation creating a backflow or back-siphonage hazard.

(i) *Used water return prohibited.* Water used for cooling of equipment, space heating or other processes shall not be returned to the potable water system. Such water shall be discharged into a drainage system through an air-gap or may be used for non-potable purposes on written approval of the department.

(j) *Water outlets.* A potable water system shall be protected against the backflow and back-siphonage by providing at each water outlet:

1. An air-gap as specified herein between the potable water outlet and the flood level rim of the fixture it supplies or between the water outlet and any other source of contamination or,

2. Where an air-gap is impractical, a backflow preventer device or vacuum breaker approved by the department.

(k) *Minimum required air-gap.* Minimum required air-gap shall be measured vertically from the lowest end of a potable water outlet to the flood rim or line of the fixture or receptacle into which it is discharged. The minimum required air-gap shall be twice the effective opening of a potable water outlet unless the outlet is a distance less than 3 times the effective opening away from a wall or similar vertical surface in which case the minimum required air-gap shall be 3 times the effective openings of the outlet. In no case shall the minimum required air-gap be less than shown in table 19.

Table 19
MINIMUM AIR-GAPS FOR PLUMBING FIXTURES

Fixture	Minimum Air-Gap	
	When Not Affected By Near Wall (Inches)	When Affected By Near Wall (Inches)
Lavatories and other fixtures with effective opening not greater than $\frac{1}{2}$ inch diameter.....	1	1½
Sink, laundry trays, goose-neck bath faucets and other fixtures with effective openings not greater than $\frac{3}{4}$ inch diameter.....	1½	2¼
Over rim bath fillers and other fixtures with effective openings not greater than 1 inch diameter	2	3
Drinking water fountains—single orifice not greater than $\frac{3}{16}$ (0.437) inch diameter or multiple orifices having total area of 0.150 square inches (area of circle $\frac{3}{16}$ inch diameter).....	1	1½
Effective openings greater than one inch.....	2 × diameter of effective opening	3 × diameter of effective opening

(l) *Devices for the protection of potable water supply.* Approved backflow preventers or vacuum breakers shall be installed with any plumbing fixture or equipment, the potable water supply outlet of which may be submerged and which cannot be protected by a minimum air-gap.

(m) *Approval of devices.* Before any device for the prevention of backflow or back-siphonage is installed, it shall be approved by the department. In its determination, the department may use the results of a recognized testing laboratory. Devices installed in the building potable water supply distribution system for protection

against backflow or back-siphonage shall be maintained in good working condition by the person or persons responsible for the maintenance of the system.

(n) *Protective devices required.* In the installation of the following list of fixtures and devices where an air-gap is not provided or is impractical, approved protective devices shall be installed in all supply lines according to table 20.

Table 20
CROSS-CONNECTIONS WHERE PROTECTIVE DEVICES ARE
REQUIRED AND CRITICAL LEVEL (C-L) SETTINGS
FOR BACKFLOW PREVENTERS¹

Fixture or Equipment	Method of Installation
Aspirators and ejectors.....	C-L at least 6 inches above flood level of receptacle
Cup beverage vending machines....	C-L at least 12 inches above flood level of machine
Dental units.....	On models without built-in vacuum breakers C-L at least 6 inches above flood level rim of bowl
Dishwashing machines.....	C-L at least 6 inches above flood level of machine
Flushometers (closet and urinal)...	C-L at least 6 inches above top of fixture supplied
Garbage can cleaning machines.....	C-L at least 6 inches above flood level of machine
Hose outlets.....	C-L at least 6 inches above highest point on hose line
Laundry machines.....	C-L at least 6 inches above flood level of machine
Turf irrigation systems.....	C-L at least 12 inches above highest sprinkler or discharge outlet
Steam tables.....	C-L at least 6 inches above flood level
Tanks and vats.....	C-L at least 6 inches above flood level rim or line
Flush tanks.....	Equip with an approved ballcock. In all cases the ballcock should be located above the overflow level of the tank and the outlet terminated one inch above the overflow or provided with a backflow preventer located at least one inch above the overflow
Hose bibbs (where aspirators or ejectors could be connected).....	C-L at least 6 inches above flood level of receptacle served

¹ Critical Level (C-L) is defined as the level to which the backflow preventer (vacuum breaker) may be submerged before backflow will occur. Where C-L marking is not shown on the preventer, the bottom of the device shall be taken as the C-L.

(o) *Connections subject to back pressure.* Where a potable water connection is made to a pipe line, fixture, tank, vat, pump or other equipment with a hazard of backflow or back-siphonage and where the water connection is subject to back pressure and an air-gap cannot be installed, the department shall require the use of an approved reduced pressure zone backflow preventer. A partial list of such connections is shown in table 21.

Table 21
PARTIAL LIST OF CROSS-CONNECTIONS SUBJECT
TO BACK PRESSURE

Chemical lines Cup beverage vending machines Dock water outlets Individual water supplies Industrial process water lines Pressure tanks	Pumps Steam lines Swimming pools Tanks and vats—bottom inlets Hose bibbs
--	--

(p) *Installation of devices.* 1. Vacuum breakers. Vacuum breakers shall be installed with the critical level at least 6 inches above the flood level rim of the fixture they serve and on the discharge side of the last control valve to the fixture. No shut-off valve or faucet shall be installed beyond the vacuum breaker.

2. Reduced pressure zone backflow preventer. A reduced pressure zone type backflow preventer may be installed subject to full static pressure.

3. Devices of all types. Backflow and back-siphonage preventing devices shall be accessibly located, preferably in the same room with the fixture they serve. Installation in utility or service spaces, provided they are readily accessible is also permitted.

4. Barometric loop. Water connections not subject to back pressure where an actual or potential backflow or back-siphonage hazard exists may in lieu of devices specified, be provided with a barometric loop. See following sketch.

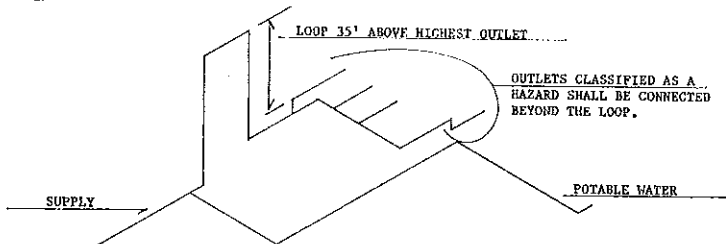

(q) *Turf sprinklers.* Turf sprinkler systems, when connected to a potable water system, shall be installed in accordance with these regulations. Adequate and proper provisions shall be made for control and drainage and to prevent back-siphonage or backflow. Water shall not be turned on to any turf sprinkler system until it has been inspected and approved. Materials used in turf sprinkler systems shall be submitted for evaluation and approval prior to installation.

(2) IMPROPER LOCATION OF SEWERS AND DRAINS AND OTHER PIPING.

(a) Sewer or drain pipes, wherever possible, shall not pass directly over areas where food, ice or potable liquids are prepared, handled, stored or displayed. Where building design requires that soil or drain pipes be located below the ceiling of such areas, the installation shall be made with the least possible number of joints and shall be installed so as to connect to a vertical stack at the nearest wall or vertical building support and the construction shall be performed as follows:

1. All openings through floors over such areas shall be provided with sleeves securely bonded to the floor construction and projecting

not less than $\frac{3}{4}$ inch above top of finished floor with space between sleeve and pipe or duct sealed.

2. Floor and shower drains installed above such areas shall be equipped with integral seepage pans.

3. Plumbing fixtures in rooms located above such areas shall be of the wall mounted type except bathtubs. Tubs shall have waste and overflow connections made above the floor and piped to trap below floor. All connections through floor and to trap shall conform with all other provisions of this regulation. No floor openings other than sleeve for waste pipe will be permitted for tubs.

4. All other soil or drain pipes shall be galvanized steel or cast iron with screwed joints sealed with litharge and glycerine or copper tube with soldered joints. Cleanouts shall be extended through the floor construction above.

5. All soil and drain pipes located above such areas shall be subjected to a standing water test of not less than 25 feet.

6. All piping subject to operation at temperatures that will form condensation on the exterior of the pipe shall be thermally insulated.

7. Where pipes are run in ceilings above such areas, the ceiling shall be of the removable type, or shall be provided with access panels in order to form a ready access for inspection of piping unless a lath and plaster ceiling is provided.

8. In lieu of the above, other methods may be approved by the department.

(b) Exposed soil, waste and other drainage pipe lines in a pool or equipment room shall not pass over the pool, surge tank or open filter.

History: 1-2-56; r. (2) through (7), Register, October, 1971, No. 190, eff. 11-1-71; r. and recr. Register, November, 1972, No. 203, eff. 12-1-72.

H 62.15 Health care and related facilities. (1) **PLAN APPROVAL REQUIRED.** Plans for plumbing and equipment for health care facilities shall be approved by the department.

(2) **SCOPE.** The scope of this section shall cover devices, fixtures and equipment which are installed and maintained in health care facilities such as hospitals, nursing or rest homes, homes for the aged, infirmaries, residential care facilities, orphanages, sanitariums, sanatoriums, clinics, mortuaries, and schools of medicine, surgery, dentistry, and research and testing laboratories whether enumerated or not. This section may also apply to offices of dentists and doctors.

(3) **INTENT.** The primary intent of the following minimum requirements is to protect public health by eliminating either potential health or safety hazards to patients and institutional personnel, and to promote the efficient use, operation and maintenance of the equipment used in the institution or establishment. Fixtures, devices and/or equipment in addition to those prescribed herein may be required dependent upon the type of occupancy, treatment, care or layout. Such additional facilities shall be installed in accord with the provisions of this chapter.

(4) **PLUMBING IN MENTAL HOSPITALS.** Special consideration shall be given to the design and installation of plumbing fixtures in areas where disturbed patients are housed. No pipes or traps shall be exposed and all fixtures shall be securely bolted through walls or floors.

(5) **SPECIAL FIXTURES AND EQUIPMENT ACCEPTABILITY.** (a) *Special fixtures.* Fixtures which are designed for any special use such as, therapy, special cleansing and/or disposal of waste materials shall be smooth, impervious, corrosion resistant materials and, if subject to temperatures in excess of 180° F., shall be able to withstand without damage, higher temperatures as may be specified. Scrub-up sinks, lavatories and sinks in patient care areas, and fixtures used by medical and nursing staff, shall have the water supply spout terminate a minimum of 5 inches above the rim of the fixture. These fixtures shall be equipped with valves or faucets which can be operated without use of the hands.

(b) *Special equipment.* All devices, appurtenances, appliances and apparatus intended to serve a special function such as sterilization, distillation, processing, cooling, storage of ice or foods, etc., which may be connected to either the water supply distribution or drainage systems or both, shall be provided with protection against back-siphonage, backflow, flooding, fouling, or any possibility of contaminating any portion of the water supply system, or equipment, or the misuse of any drain.

(c) *Therapeutic equipment.* Therapeutic equipment shall not be counted as a patient bathing fixture to meet the required patient bath ratio.

(6) **FIXTURE AND EQUIPMENT INSTALLATION.** (a) *Clinic sinks.* Such fixtures shall have an integral trap in which the upper portion of a visible trap seal provides a water surface. The fixture shall be designed so as to permit complete removal of the contents by siphonic and/or blow-out action, and to reseal the trap in a single flushing operation. A flushing rim shall provide water to cleanse the interior surface. The fixtures shall have flushing and cleansing characteristics similar to a water closet.

(b) *Prohibited use of clinic sinks and service sinks.* A clinic sink shall not be used as a janitor's service sink. A janitor's service sink shall not be used for the disposal of urine, fecal matter, or other human wastes.

(c) *Special requirement for ice manufacture and storage.* 1. No machines for manufacturing ice, or any device for handling or storing ice, shall be located in a room containing a bedpan hopper, clinic sink, bedpan washer, or similar fixture. Machines for manufacturing ice, or devices for handling or storing ice intended for either human consumption or packs, shall be located in a clean utility room, a floor pantry, a diet kitchen, or in other similar locations.

2. Each drain serving an ice chest or box shall discharge into an indirect waste receptor. Each drain shall discharge through an air-break above the receptor. The end of the drain shall be covered with a removable 10 mesh per inch noncorrosive screen.

(7) **STERILIZERS.** (a) *Descaling prohibited.* The interior of water sterilizers, stills, or similar equipment shall not be descaled or otherwise treated by acid or other chemical solutions while the equipment is connected to the water and/or drainage systems.

(b) *Compliance with boiler and unfired pressure vessel code.* Pressure sterilizers and pressure type instrument washer sterilizers installed after the effective date of this code shall be constructed and stamped in accordance with the provisions of Wis. Adm. Code

section Ind 41.50 (1) (e). All pressure sterilizers and pressure type instrument washer sterilizers regardless of size shall be equipped with pressure relief devices in accordance with the provisions of Wis. Adm. Code section Ind 41.50 (1) (e).

(c) *Sterilizer piping.* The connecting piping and/or devices for sterilizers shall be accessible for inspection and maintenance.

(d) *Bedpan washers and clinic sinks.* Bedpan washers and clinic sinks shall be connected to the sanitary drainage system and vented in accordance with the requirements for water closets. Vapor vents serving bedpan washers shall not connect to the plumbing system.

(8) DRAINAGE AND VENTING. (a) *Sterilizer wastes.* 1. Indirect wastes required. All sterilizers shall be provided with individual and separate indirect wastes, with air-gaps of not less than 2 diameters of the waste tailpiece. The upper rim of the receptor, funnel, or basket type waste fitting shall be not less than 2 inches below the vessel or piping, whichever is lower. Except as provided in sections H 62.15 (8) (a) 3. and 5., a "P" trap shall be installed on the discharge side of and immediately below the indirect waste connection serving each sterilizer.

2. Floor drain required. In any room containing the recessed, or concealed portions of sterilizers, not less than one acceptable floor drain, connecting to the drainage system, shall be installed in a manner to drain the entire floor area. The floor drain waste and trap shall be a minimum diameter of 3 inches. It shall receive the drainage from at least one sterilizer within the room to assure maintenance of the floor drain trap seal. The sterilizer drain may be installed on a branch taken off between the floor drain trap and the strainer. No individual sterilizer waste trap shall be required on this type of installation. See following sketch.

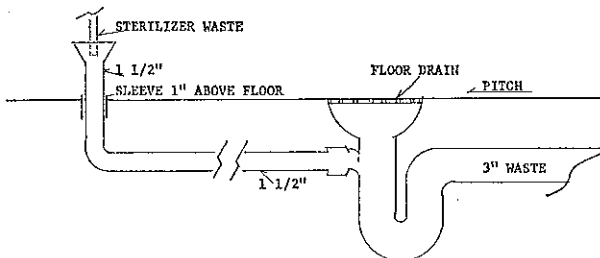

3. Battery assemblies. A battery assembly of not more than 3 sterilizer wastes may drain to one trap, provided the trap and waste are sized according to the combined fixture unit rating; the trap is located immediately below one of the indirect waste connections; the developed distance of a branch does not exceed 8 feet; and the branches change direction through a tee-wye or wye pattern fitting.

4. Bedpan steamers, additional trap required. A trap with a minimum seal of 3 inches shall be provided in a bedpan steamer drain located between the fixture and the indirect waste connection.

5. Pressure sterilizer. Except when an exhaust condenser is used, a pressure sterilizer chamber drain may be connected to the exhaust drip tube before terminating at the indirect waste connection. If a

vapor trap is used, it shall be designed and installed to prevent moisture being aspirated into the sterilizer chamber. The jacket steam condensate return, if not connected to a gravity steam condensate return, shall be separately and indirectly wasted. If necessary to cool a high temperature discharge, a cooling receiver, trapped on its discharge side, may serve as the fixture trap.

6. Pressure sterilizer exhaust condensers. The drain from the condenser shall be installed with an indirect waste. If condensers are used on pressure sterilizers, the chamber drain shall have a separate indirect waste connection.

7. Water sterilizer. All water sterilizer drains, including tank, valve leakage, condenser, filter and cooling, shall be installed with indirect waste or according to section H 62.15 (8) (a) 2.

8. Pressure instrument washer-sterilizer. The pressure instrument washer-sterilizer chamber drain and overflow may be interconnected. Also, they may be interconnected with the condenser.

(b) *Vapor vent material.* Material for vapor vents serving bedpan washers and sterilizer vents serving sterilizers shall be materials approved for vent piping.

(c) *Vent connections prohibited.* Connections between vapor vents serving bedpan washers, sterilizing apparatus, and/or normal sanitary plumbing systems, are prohibited.

(d) *Vapor vents and stacks.* 1. Bedpan washers shall be vented to the outer atmosphere above the roof by means of one or more vapor vents. The vapor vent for a bedpan washer shall be not less than a 2-inch diameter pipe. A vapor vent serving a single bedpan washer may drain to the fixture served.

2. Multiple installations. Where bedpan washers are located above each other on more than one floor, a vapor vent stack may be installed to receive the vapor vent on the various floors. Not more than 3 bedpan washers shall be connected to a 2-inch vapor vent stack, 6 to a 3-inch vapor vent stack, and 12 to a 4-inch vapor vent stack. In multiple installations, the connections between a bedpan washer vapor vent and a vapor vent stack shall be made by use of a tee or tee-wye sanitary pattern drainage fittings, installed in an upright position.

3. Trap required. The bottom of the vapor vent stack, except when serving only one bedpan washer, shall be drained by means of a trapped and vented waste connection to the plumbing sanitary drainage system. The trap and waste shall be the same size as the vapor vent stack.

4. Trap seal maintenance. A water supply of not less than $\frac{1}{4}$ inch minimum tubing shall be taken from the flush supply of each bedpan washer on the discharge or fixture side of the vacuum breaker, trapped to form not less than a 3-inch seal, and connected to the vapor vent stack on each floor. The water supply shall be so installed as to provide a supply of water to the vapor vent stack for cleansing and drain trap seal maintenance each time a bedpan washer is flushed.

(e) *Sterilizer vapor vent and stacks.* 1. Connections. Multiple installations of pressure and nonpressure sterilizers shall have their vent connections to the sterilizer vent stack made by means of inverted wye fittings. Such vent connections shall be accessible for inspection and maintenance.

2. Drainage. The connection between sterilizer vent and/or exhaust openings and the sterilizer vent stack shall be designed and installed to drain to the funnel or basket-type waste fitting. In multiple installations, the sterilizer vent stack shall be drained separately to the lowest sterilizer funnel or basket-type waste fitting or receptor.

(f) *Sterilizer vapor vent stack sizes.* 1. Bedpan steamers. The minimum size of a sterilizer vent serving a bedpan steamer shall be $1\frac{1}{2}$ inches in diameter. Multiple installation shall be sized according to table 22.

Table 22
VAPOR VENT STACK SIZES FOR BEDPAN STEAMERS
AND BOILING TYPE STERILIZERS

(Number of connections of various sizes permitted to various sized sterilizer vent stacks)

Stack size	Connection size	
	$1\frac{1}{2}$ "	2"
$1\frac{1}{2}$ -inch ¹	1 or	0
2-inch ¹	2 or	1
2-inch ²	1 and	1
3-inch ¹	4 or	2
3-inch ²	2 and	2
4-inch ¹	8 or	4
4-inch ²	4 and	4

¹Total of each size.

²Combination of sizes.

2. Boiling type sterilizers. The minimum size of a sterilizer vent stack shall be 2 inches in diameter when serving a utensil sterilizer, and $1\frac{1}{2}$ inches in diameter when serving an instrument sterilizer. Combinations of boiling type sterilizer vent connections shall be based on table 22.

3. Pressure sterilizers. Sterilizer vent stacks shall be $2\frac{1}{2}$ inches minimum; those serving combinations of pressure sterilizer exhaust connections shall be sized according to table 23.

Table 23
VAPOR VENT STACK SIZES FOR PRESSURE STERILIZERS

(Number of connections of various sizes permitted to various sized vent stacks)

Stack size	Connection size			
	$\frac{3}{4}$ "	1"	$1\frac{1}{4}$ "	$1\frac{1}{2}$ "
$1\frac{1}{2}$ -inch ¹	3 or	2 or	1	-----
$1\frac{1}{2}$ -inch ²	2 and	1	-----	-----
2-inch ¹	6 or	3 or	2 or	1
2-inch ²	3 and	2	-----	-----
2-inch ²	2 and	1 and	1	-----
2-inch ²	1 and	1 and	-----	1
3-inch ¹	15 or	7 or	5 or	3
3-inch ²	-----	1 and	2 and	2
3-inch ²	1 and	5 and	-----	1

¹Combination of sizes.

²Total of each size.

4. Pressure instrument washer-sterilizer sizes. The minimum size of a sterilizer vent stack serving an instrument washer-sterilizer

shall be 2 inches in diameter. Not more than two sterilizers shall be installed on a 2-inch stack, and not more than four on a 3-inch stack.

(9) **FLOOR DRAINS PROHIBITED.** Floor drains shall not be installed in operating or delivery rooms.

(10) **WATER SUPPLY.** (a) *Water services.* All hospitals shall be provided with at least 2 water service connections and whenever more than one street main is available, the connections shall be made to different street mains.

1. The water service pipe for all other health care facilities shall be of sufficient size to furnish water to the building in the quantities and at the pressures required in Wis. Adm. Code sections H 62.13 (4) (d) and (h) 3. and H 62.15 (10) (c).

2. Water services shall be in accord with the requirements of Wis. Adm. Code section H 62.13 (2).

(b) *Water distribution control valves.* 1. Four or less patient care units, containing not more than two persons per unit exclusive of intensive care coronary units, may be served with one branch control valve. All fixtures, appliances, appurtenances, lawn sprinkler faucets and wall hydrants shall be valved. See following sketch.

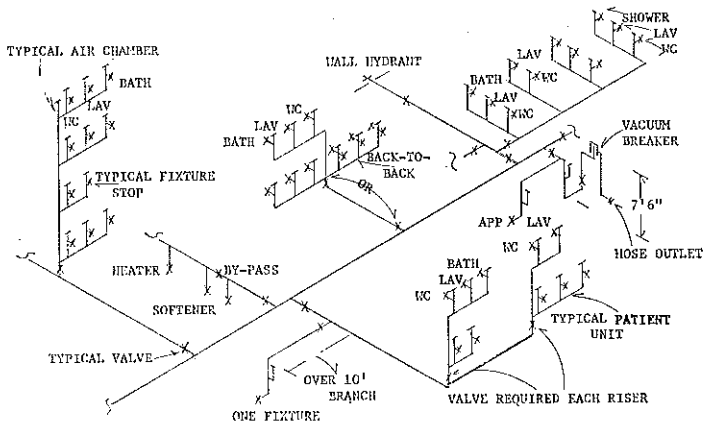

2. Control valves for risers, water heating equipment, water softeners and tank controls shall be in accord with Wis. Adm. Code section H 62.13 (4) (c), (d), (e) and (h). Control valve accessibility and design shall be in accord with section H 62.13 (4) (f) and (g), Wis. Adm. Code. See above sketch.

(c) *Velocities and flow capacities.* Water supply piping shall be designed to provide service to upper floor installations at a minimum pressure of 15 (p.s.i.) pounds per square inch during maximum demand periods. Velocities shall not exceed 8 (f.p.s.) feet per second. Where static pressure exceeds 80 (p.s.i.) pounds per square inch, pressure reducing controls shall be installed to avoid fracture or other damage to the system. The supply demand in gallons per minute in the building water distribution system shall be determined on the basis of the load in terms of supply fixture units and of the relationship between load and supply demand as shown in table 24 and pertinent portions of tables 13 and 14.

Table 24
DATA FOR ESTIMATING WATER SUPPLY DEMAND AND WASTE REQUIREMENTS

Fixture	Fixture Units		Minimum Pipe Sizes, Inches				Remarks
	Water	Waste	Waste	Trap	Vent	Cold Water	
Water closet (tank)	6	6	3	2	2	3/4	1/2
Water closet (flush valve)	10	8	3	2	2	1	1/2
Lavatory	2	1	1 1/2	1 1/4	1 1/4	1/2	1/2
Urinal (tank)	3	4	2	2	1 1/2	1	1/2
Urinal (flush valve)	5	4	2	2	1 1/2	1	1/2
Shower	4	4	3	3	1 1/2	1 1/2	1 1/2
Patient bath (public)	4	2	3	1 1/2	1 1/2	1 1/2	1 1/2
Patient bath (pvt.)	4	3	1 1/2	1 1/2	1 1/2	1 1/2	1 1/2
Drinking fountain	2	3	1 1/2	1 1/4	1 1/4	1 1/2	1 1/2
Sitz bath	1	1/2	1 1/2	1 1/4	1 1/4	1 1/2	1 1/2
Clinical sink	4	4	1 1/2	1 1/2	2	1	1/2
(Flushing rim)	10	6	3	3	2	1	1/2
Scrub sink	4	3	2	2	1 1/2	3/4	3/4
Single sink for misc. hospital use	4	3	1 1/2	1 1/2	1 1/2	3/4	3/4
Double sink for misc. hospital use	4	4	2	2	1 1/2	3/4	3/4
Laboratory sink	4	4	2	2	1 1/2	3/4	3/4
Ice machine	1	1	2	2	1 1/2	3/4	3/4
Plaster sink	6	4	2	2	1 1/2	3/4	3/4
X-ray tank	4	2	1 1/2	1 1/2	2	1	3/4
Bedpan sanitizer	10	6	3	2	2	1	3/4
Autopsy table	4	4	3	2	1 1/2	3/4	3/4
Animal area sinks	4	4	2	2	1 1/2	3/4	3/4
Cup sink	1	1	1 1/4	1 1/4	1 1/4	1 1/4	1 1/4

(d) *Piping insulation.* Circulating, hot, cold and chilled water piping shall be insulated. Cold and chilled water pipe insulation shall have an integral or separate vapor barrier.

(e) *Special piping systems.* Distilled water, ionized water, laboratory and other special piping systems shall be included in the plans submitted. The plans shall incorporate sufficient detail to clearly establish the installation proposed.

(f) *Water supply protection.* The installation of the water supply shall meet all the applicable requirements prescribed in Wis. Adm. Code sections H 62.13 and H 62.14, and as provided in table 25 including the corresponding reference number.

Table 25

Equipment	Protective Device	Location	Reference No.
Bath with shampoo nozzle.....	Vacuum breaker	6'0" above bottom of tub	1
Bedpan sanitizer.....	Vacuum breaker	Part of flush valve	1
Bedpan washer hose.....	Vacuum breaker	5'9" above floor	1
Hose and faucet at service sink.....	Vacuum breaker	6" above normal use of hose	1
Sterilizer condenser.....	Vacuum breaker	6" above unit	1
Flash washer.....	Vacuum breaker	6" above unit	1
Glove washer.....	Vacuum breaker	6" above unit	1
Stills.....	Air-gap	On discharge	5
Ultrasonic cleaner.....	Vacuum breaker	6" above unit	1
Developing tank.....	Vacuum breaker	6" above unit	1
Dental unit.....	Vacuum breaker	Part of unit	1
Hydrotherapy bath.....	Vacuum breaker	6" above unit	1
Radiology cooling coil (water bath).....	Air-gap	On discharge	5
Pipette washer.....	Vacuum breaker	6" above unit	1
Laboratory spout.....	Vacuum breaker	At threaded discharge	2
Cage washer.....	Vacuum breaker	6" above unit	1
Tube washer.....	Vacuum breaker	Part of control valve	1
Bottle washer.....	Vacuum breaker	6" above unit	1
Food waste grinder.....	Vacuum breaker	6" above unit	1
Peeler.....	Air-gap	On supply	4
Dishwasher.....	Vacuum breaker	6" above unit	1
Can washer.....	Vacuum breaker	6" above unit	1
Ice machine.....	Air-gap	On discharge	5
Pot washer.....	Vacuum breaker	6" above unit	1
Coffee urn.....	Vacuum breaker	6" above unit	1
Glass washer.....	Vacuum breaker	6" above unit	1
Refrigeration condenser.....	Air-gap	On discharge	5
Clothes washer.....	Vacuum breaker	6" above unit	1
Soap and brine tanks.....	Vacuum breaker	6" above unit	1
Autopsy table.....	Vacuum breaker	6'0" above floor	1
Aspirator.....	Vacuum breaker	6'0" above floor	1
Hose station.....	Vacuum breaker	At threaded discharge	2
Flush rim floor drain.....	Vacuum breaker	5'9" above floor	1
Incinerator gas washer.....	Air-gap	On water supply	5
Lawn sprinklers.....	Vacuum breaker	Outdoor type	1
Wall hydrant.....	Vacuum breaker	At threaded discharge	2
Hose bibb.....	Vacuum breaker	At threaded discharge	2
Package air-conditioner.....	Air-gap	On discharge	5
Cooling tower.....	Backflow preventer	On water supply	3
Boiler make-up water.....	Backflow preventer	On water supply	3
Vacuum pumps and air washing.....	Air-gap	On water supply	4
Spray coil for air washing.....	Vacuum breaker	6" above unit	1
Expansion tank.....	Backflow preventer	On water supply	3

1. The designation "vacuum breaker" means a non-pressure, atmospheric type device. The installation elevation means the distance above the spill level of the fixture or equipment served, or the height to which a connected discharge may be raised to cause gravity backflow to reach the device. The designated installation shall be measured from the bottom of the device, or the critical level marking

if indicated on the device. The installation and elevation shall permit the vacuum breaker to drain and actuate each time the control valve is operated. No shut-off valve shall be permitted downstream from the vacuum breaker. The vacuum breaker shall not be installed in a manner so as to be under continuous pressure.

2. The location "at the threaded discharge" means the location where an aerator would normally be installed. The vacuum breaker is the in-line type and for the laboratory faucet the serrated nozzle is then screwed into the discharge end of the vacuum breaker. When this vacuum breaker is used with a hose bibb, it is threaded onto the male end and the hose is connected to the vacuum breaker.

3. The designation "backflow preventer" means the reduced pressure type backflow preventer which includes two spring loaded check valves, a broken connection to a drain and usually two gate valves. The use of this device requires that adequate and rapid drainage be available.

4. An air-gap on the water supply means that the air-gap shall be located at the supply opening to the fixture or equipment it serves. An air-gap is the minimum vertical distance between the supply discharge orifice and the spill level of the receptor, fixture or equipment served. This minimum vertical distance shall be at least two diameters of the discharge orifice, or a minimum of one inch, whichever is the greatest.

5. An air-gap on the waste line means an indirect connection between the fixture or equipment and the waste receptor. The waste discharge orifice governs the minimum distance according to section H 62.15 (10) (f) 4.

(g) *Hot water supply control.* Hot water supply to patients' showers, therapeutic equipment, and continuous baths shall be provided with control valves automatically regulating the temperature of the water supply to the fixture. The valve shall fail in a closed position when the tempered water supply to the fixture exceeds 110° F.

(h) *Hot water supply.* The water supply distribution system shall be designed to provide hot water at each applicable fixture at all times. The system shall be of a circulating type. The circulating pumps shall be arranged for continuous operation or shall be controlled by an aquastat in the circulating piping. See Wis. Adm. Code section H 62.13 (4) (i) 3.

(i) *Water heaters and tanks.* Storage tanks when provided shall be fabricated of non-corrosive metal or be lined with non-corrosive material. The water heating equipment shall have a sufficient capacity to supply water at the temperature and amounts in table 26.

Table 26

	Patient Areas	Clinical	Dietary	Laundry (2 gals. per lb. of laundry)
Gal/hr/bed.....	6½	6½	4	4½
Temp. °F. (Maximum).....	110°	125°	180°	180°

(11) **ASPIRATORS.** The use of water aspirators shall be limited to those units approved by the department.

(12) **SPOUTS AND ACTIONS—HOSPITAL AND NURSING HOME FIXTURES.**

(a) The selection of spouts and actions for hospital and nursing home plumbing fixtures shall comply with section H 62.15 (12) (b) and table 27.

(b) Lavatories and sinks required in patient care areas shall have the water supply spout mounted so that its discharge point is a minimum distance of 5 inches above the rim of the fixture. All fixtures used by medical and nursing staff, and all lavatories used by patients and food handlers shall be trimmed with valves which can be operated without the use of hands. Where blade handles are used for this purpose they shall not exceed 4½ inches in length, except that handles on scrub sinks and clinical sinks shall be not less than 6 inches long.

Table 27

SPOUTS AND ACTIONS FOR HOSPITAL AND NURSING HOME FIXTURES

Location	Type of Spout	Type of Action Minimum
NURSING DEPARTMENT		
Patient toilet room.....	Gooseneck	Wrist
Patient toilet room— isolation.....	Gooseneck	Knee
Utility room.....	Gooseneck	Wrist
Treatment room.....	Gooseneck	Wrist
Medicine room.....	Gooseneck	Wrist
Lavatory in floor kitchen.....	Gooseneck	Wrist
Sink in floor kitchen.....	Sink faucet	Wrist
Nurses toilet room.....	Lavatory supply	Hand
Floor laboratory.....	Laboratory gooseneck	Vertical hand
NURSERY		
Nursery.....	Gooseneck	Wrist
Suspect nursery.....	Gooseneck	Wrist
Examination and treatment.....	Gooseneck	Wrist
Premature nursery.....	Gooseneck	Foot
Formula room.....	Gooseneck	Wrist
Labor room.....	Gooseneck	Wrist
SURGICAL		
Scrub room.....	Gooseneck with spray head	Knee
Sub-sterile room.....	Sink faucet	Wrist
Clean-up room.....	Sink faucet	Wrist
Frozen sections room.....	Laboratory gooseneck	Vertical hand
Surgical supply room.....	Gooseneck	Wrist
Work room.....	Sink faucet	Wrist
Cystoscopic room.....	Gooseneck with spray head	Knee
Fracture room.....	Sink faucet	Wrist
Recovery room.....	Gooseneck	Foot
CENTRAL SUPPLY		
Work room.....	Sink faucet	Wrist
Solutions room.....	Sink faucet	Wrist
Needle and syringe room.....	Sink faucet	Wrist
Glove room.....	Gooseneck	Wrist
Pharmacy.....	Laboratory gooseneck	Vertical hand
Manufacturing.....	Gooseneck	Wrist
EMERGENCY DEPARTMENT		
Observation bedroom.....	Gooseneck	Wrist
Utility room.....	Gooseneck	Wrist
Operating room.....	Gooseneck with spray head	Knee
D. O. A. room.....	Gooseneck	Wrist
Examination room.....	Gooseneck	Wrist

Table 27—continued
SPOUTS AND ACTIONS FOR HOSPITAL AND NURSING
HOME FIXTURES

Location	Type of Spout	Type of Action Minimum
DIAGNOSTIC AND TREATMENT		
Occupational therapy.....	Gooseneck	Wrist
Hydro-therapy room.....	Gooseneck	Wrist
Examination room.....	Gooseneck	Wrist
Deep therapy.....	Gooseneck	Wrist
Superficial therapy.....	Gooseneck	Wrist
Radium treatment and exam.....	Gooseneck	Wrist
Toilet room.....	Gooseneck	Wrist
Dark room.....	Sink faucet	Hand
Autopsy.....	Gooseneck with spray head	Knee
Lavatory in autopsy shower room.....	Gooseneck	Wrist
Laboratories.....	Laboratory gooseneck	Vertical hand
OUTPATIENT DEPARTMENT		
Examination and treatment room.....	Gooseneck	Wrist
Dental operating.....	Gooseneck	Knee
Dental laboratory.....	Laboratory gooseneck	Vertical hand
Dental recovery.....	Gooseneck	Wrist
Surgical room.....	Gooseneck with spray head	Knee
Eye examination room.....	Gooseneck	Knee
Ear, nose and throat room.....	Gooseneck	Knee
SERVICE DEPARTMENT		
Lavatory in kitchen.....	Lavatory supply	Wrist

(13) RADIOACTIVE MATERIALS. See Wis. Adm. Code chapter H 57.

History: 1-2-56; am. (3) (4) and (5), Register, August, 1961, No. 63, eff. 9-1-61; r. and recr. Register, November, 1972, No. 203, eff. 12-1-72.

H 62.16 Mobile homes. (1) **GENERAL.** (a) *Code compliance.* The plumbing system installed in a mobile home shall conform with the provisions of this section. Provisions not indicated in this section are referred to applicable Wis. Adm. Code sections of chapter H 62.

(b) *Workmanship.* All design, construction and workmanship shall conform with accepted engineering practices and shall be of such character as to secure the results sought to be obtained by this section.

(2) **PROHIBITED FITTINGS AND PRACTICES.** (a) Drainage or vent piping shall not be drilled and tapped for the purpose of making connections.

(b) Except as specifically provided elsewhere in this section, vent pipes shall not be used as soil or waste pipes.

(c) Fittings, connections, devices, or methods of installation that obstruct or retard the flow of sewage or air in the drainage or venting systems in an amount greater than the normal frictional resistance to flow shall not be used unless approved by the department.

(d) Cracks, holes or other imperfections in materials shall not be concealed by welding, brazing or soldering or by paint, wax, tar or other leak-sealing or repairing agents.

(e) Piping, fixtures or equipment shall be located so as not to interfere with the normal use or with the normal operation and use of windows, doors or other required facilities.

(f) All valves, pipes and fittings shall be installed in correct relationship to the direction of flow.

(3) **PROTECTIVE REQUIREMENTS.** (a) *Cutting structural members.* Structural members shall not be unnecessarily or carelessly weakened by cutting or notching.

(b) *Exposed piping.* All piping, pipe threads, hangers, and supports exposed to the weather, water, mud, and road hazard, and subject to damage therefrom, shall be painted, coated, wrapped, or otherwise protected from deterioration.

(c) *Road damage.* Pipes, supports, drains, outlets, or drain hoses shall not extend or protrude in a manner where they could be unduly subjected to damage during transit.

(d) *Rodent resistance.* All exterior openings around piping and equipment shall be sealed to resist the entrance of rodents.

(e) *Freezing.* All piping and fixtures subject to freezing temperatures shall be insulated or protected to prevent freezing under normal occupancy. All water distribution piping shall be aligned and graded to permit draining.

(4) **MATERIALS—QUALITY AND WEIGHT.** (a) *Minimum standards.* Materials, fixtures, or devices used or entering into the construction of plumbing systems in any mobile home shall be free from defects and shall conform to Wis. Adm. Code section H 62.19, or materials approved by the department.

(b) *Specific usage.* Each of the following subsections indicates specifically the type of material permitted for use in the various parts of the plumbing system.

(5) **JOINTS AND CONNECTIONS.** (a) *Tightness.* Joints and connections in the plumbing system shall be gastight and watertight for the pressures required under testing procedures. See Wis. Adm. Code section H 62.23.

(b) *Assembling of pipe.* All joints and connections shall be correctly assembled for tightness. Pipe threads shall be fully engaged with the threads of the fitting. Plastic pipe and copper tubing shall be inserted to the full depth of the welding sockets or solder cup of each fitting. Pipe threads and slip joints shall not be wrapped with string, paper, putty, or similar fillers.

(c) *Threaded joints.* All burrs shall be removed. Pipe ends shall be reamed out to size of bore, and all chips and cutting oil shall be removed. Pipe joint thread compound shall be applied to male threads only.

(d) *Solder joints.* Solder joints for tubing shall be made with approved solder type fittings. Surfaces to be soldered shall be cleaned bright. The joints shall be properly fluxed with noncorrosive paste type flux and made with approved 50-50 solder or an approved solder having a higher melting temperature.

(e) *Plastic pipe and fittings.* Plastic pipe and fittings shall be joined by installation methods approved by the department.

(f) *Union joints.* Metal unions shall have metal-to-metal ground seats.

(g) *Flared joints.* Flared joints for soft copper water tubing shall be made with approved fittings. The tubing shall be expanded with a proper flaring tool.

(6) **TRAPS.** (a) *Traps required.* Each plumbing fixture shall be separately trapped by an approved water seal "P" trap. All traps shall be vented.

(b) *Two compartment sink.* A 2-compartment sink may be connected to one "P" trap and may be considered as a single fixture for the purpose of drainage and vent.

(c) *Prohibited traps.* A trap which depends for its seal upon concealed interior partitions shall not be used. Full "S" traps, bell traps, drum traps, crown-vented traps, and running traps are prohibited. Fixtures shall not be double trapped.

(d) *Material and design.* 1. *Material.* Traps shall be manufactured of cast iron, cast brass, or drawn brass tubing of not less than No. 17 Brown and Sharpe gauge, or approved plastic, or other approved material.

2. *Design.* a. Each trap shall be self-cleaning with a smooth and uniform interior waterway. Union joints for a trap shall be beaded to provide a shoulder for the union nut. Each trap shall have the manufacturer's name stamped or cast on the trap. Each tubing trap shall show the gauge of the tubing.

b. *Trap cleanouts.* All fixture traps shall be so designed and installed that stoppages may be removed. All small fixture traps shall be provided with cleanouts of the screw plug or removable dip type. Where the "U" or dip is removable the coupling nut on the discharge side shall be within the dip of the trap. Traps for urinals rising from the floor and traps serving shower baths and floor drains, when inaccessible, shall be so installed as to make the removable inlet serve as a cleanout.

(e) *Trap seal.* Each "P" trap shall have a water seal of not less than 2 inches and not more than 4 inches and shall be set true to its seal.

(f) *Size.* Traps shall be not less than 1¼ inches in diameter. A trap shall not be larger than the waste pipe to which it is connected. See Wis. Adm. Code section H 62.03 (1), table 1, for proper trap size.

(g) *Location.* Each trap shall be located as close as possible to its fixture outlet.

(h) *Distance from trap to vent.* The distance between a "P" trap and its vent or vented waste line shall be in accordance with table 28. See sketch following table 28.

Table 28
DISTANCE OF FIXTURE TRAP FROM VENT

Size of Fixture Drain (Inches)	Distance Trap to Vent
1¼	3 feet
2	4 feet
3	6 feet

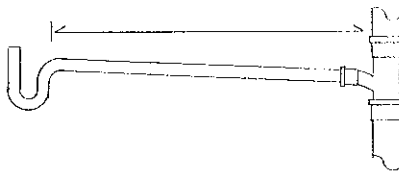

(i) *Length of tailpiece.* The vertical distance of any waste connection between the top of the fixture strainer or opening to the center line of the horizontal waste pipe shall be as close as possible but shall not exceed 15 inches, except floor drains shall not exceed 24 inches. Floor outlet water closets may have a distance of 36 inches between the water level of the fixture and the center line of the horizontal soil pipe serving same.

(j) *Installation.* 1. Grade of trap arm. The piping between a "P" trap and the fixture tee or the vented waste line shall be graded $\frac{1}{4}$ inch per foot towards the vent and in no event shall have a slope greater than its diameter. The vent opening at fixture tees shall not be below the invert of the "P" trap outlet.

2. Trap arm offset. The piping between the "P" trap and vent may change direction or be offset horizontally with the equivalent of no more than 180 degrees.

3. Concealed "P" traps. "P" traps with slip joint connections shall be readily accessible for repair and inspection.

(7) **CLEANOUTS.** (a) *When installed.* Cleanouts shall be installed if the drainage system cannot be cleaned through fixtures, drains, or vents. Cleanouts shall also be provided when fittings of more than 45 degrees are used to effect an offset except where long turn ells are used which provide sufficient "sweep" for cleaning.

(b) *Cleaning tool.* A cleaning tool shall not be required to pass through more than 360 degrees of fittings, excluding removable "P" traps, to reach any part of the drainage system.

(c) *Access to cleanouts.* Cleanouts shall be accessible through an unobstructed minimum clearance of 12 inches directly in front of the opening. Each cleanout fitting shall open in a direction opposite to the flow or at right angles to the pipe. Concealed cleanouts that are not provided with access covers shall be extended to a point above the floor or outside of the mobile home, with pipe and fittings installed, as required, for drainage piping without sags and pockets.

(d) *Material.* Plugs shall be brass or approved plastic with screw pipe threads.

(e) *Design.* Cleanout plugs shall have raised heads except that plugs at floor level shall have inverted sockets.

(8) **PLUMBING FIXTURES.** (a) *Quality of fixtures.* Plumbing fixtures shall have smooth impervious finishes, be free from defects and concealed fouling surfaces, be capable of resisting road shock and vibration and shall conform in quality and design to approved standards.

(b) *Strainers.* The waste outlet of all plumbing fixtures, other than water closets, shall be equipped with a drain fitting that will provide an adequate unobstructed waterway.

(c) *Fixture connections.* Fixture tailpieces and continuous wastes in exposed or accessible locations shall be not less than No. 17 Brown and Sharpe gauge seamless drawn-brass tubing or other approved pipe or tubing materials. Inaccessible fixture connections shall be constructed according to the requirements for drainage piping. Each fixture tailpiece, continuous waste, or waste and overflow shall be not less than $1\frac{1}{2}$ inches for sinks of two or more compartments,

dishwashers, clothes washing machines, laundry tubs, bathtubs, and not less than 1½ inches for lavatories.

(d) *Concealed connections.* Approved concealed slip joint connections shall be provided with adequately sized unobstructed access panels and shall be accessible for inspection and repair.

(e) *Directional fitting.* An approved "Y" or other directional type branch fitting shall be installed in every tailpiece or continuous waste that receives the discharge from food waste disposal units, dishwashing, or other force-discharge fixture or appliance. See section H 62.16 (8) (h) 2.

(f) *Water closets.* 1. Each water closet shall be designed and manufactured according to approved standards and shall be equipped with a water flushing device capable of adequately flushing and cleaning the bowl at each operation of the flushing mechanism. See Wis. Adm. Code section H 62.19.

2. Water closet flushing devices shall be designed to replace the water seal in the bowl after each operation. Flush valves, flushometer valves, and ballcocks shall operate automatically to shut off at the end of each flush or when the tank is filled to operating capacity.

3. Flush tanks shall be fitted with an overflow pipe large enough to prevent flooding at the maximum flow rate of the ballcock. Overflow pipes shall discharge into the water closet through the tank.

4. Water closets that have fouling surfaces that are not thoroughly washed at each discharge shall be prohibited. Any water closet that might permit the contents of the bowl to be siphoned back into the water system shall be prohibited.

5. Floor connection. Water closets shall be securely bolted to the floor by means of an approved flange or other approved fitting. Bolts and screws, when used, shall be of solid brass or other corrosive resistant materials approved by the department and shall be not less than ¼ inch in diameter. A watertight seal shall be made between the water closet and flange or other approved fitting by use of a gasket or sealing compound.

(g) *Shower stalls.* 1. Each shower stall shall be provided with an approved watertight receptor with sides and back extending one inch above the finished dam or threshold. In no case shall the depth of a shower receptor be less than 2 inches or more than 9 inches measured from the top of the finished dam or threshold to the top of the drain. The wall area in shower compartments shall be constructed of smooth, noncorrosive, and nonabsorbent waterproof materials to a height not less than 6 feet above the floor level. Such walls shall form a watertight joint with each other and with the receptor or shower floor. The floor shall slope uniformly to the drain at not less than ¼ nor more than ½ inch per foot.

2. The joint around the drain connection and around the water closet outlet in combination compartments shall be made watertight by a flange, clamping ring, or other approved means.

3. Shower doors and tub and shower enclosures shall be constructed so as to be waterproof and, if glazed, glazing shall comply with A.N.S.I. Z97.1—1966.

4. Prefabricated shower stalls shall be approved and shall comply with all the requirements of this chapter relating to plumbing fixtures and shower stalls.

(h) *Dishwashing machines.* 1. Dishwashing machines shall not be directly connected to any waste piping, but shall discharge its waste through a fixed air-gap installed above the machine. The drain connection from the air-gap may connect to an individual trap or to a directional fitting installed in the sink tailpiece.

2. The drain from a dishwashing machine shall not be connected to a food waste disposal unit, sink tailpiece or continuous waste on the discharge side of a food waste disposal unit. Two traps shall be used when a sink, food waste disposal, and dishwashing machine are installed. See following sketches.

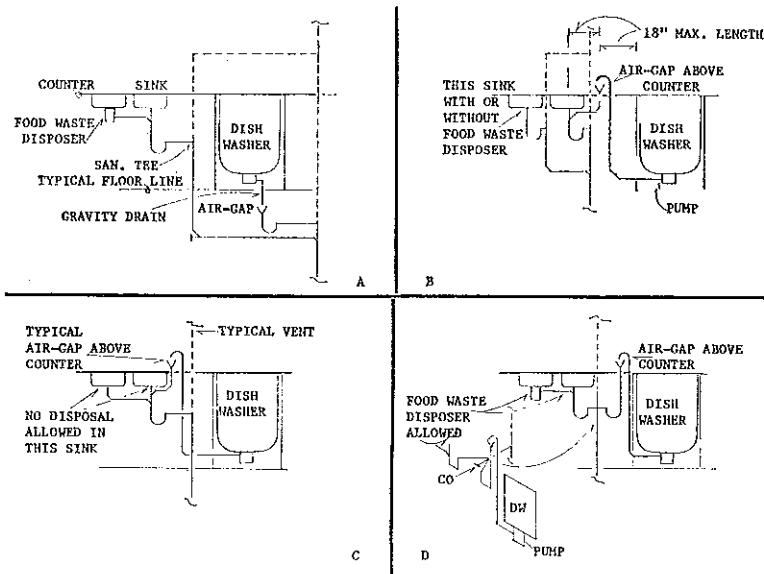

(i) *Clothes washing machines.* 1. Clothes washing machines shall drain either into a properly vented trap, into a properly vented and trapped open standpipe, or over the rim of a laundry tub.

2. Standpipes shall be 1½ inches minimum inside diameter pipe size or 1½ inches brass tubing not less than No. 17 Brown and Sharpe gauge. Standpipes shall discharge into a vented trap. Each standpipe shall extend not less than 18 inches or more than 30 inches above its trap and shall terminate in an accessible location not less than 6 inches above the highest water level of the clothes washing machine.

3. A clothes washing machine drain shall not be connected to the tailpiece, continuous waste, or trap of any sink or dishwashing machine.

(j) *Installation.* 1. Access. Each plumbing fixture shall be located and installed in a manner to provide easy access for cleaning and repair.

2. Alignment. Fixtures shall be set level and in true alignment with adjacent walls. Where practical, piping from fixtures shall extend to the nearest wall.

3. Brackets. Wall-hung fixtures shall be rigidly attached to walls by metal brackets or supports without any strain being transmitted to the piping connections. Flush tanks shall be securely fastened to water closets or to the wall with approved corrosive resistant materials.

(9) HANGERS AND SUPPORTS. (a) 1. *Strains and stresses.* Piping in the plumbing system shall be installed without undue strains and stresses, and provision shall be made for expansion, contraction, and structural settlement.

2. Piping supports. Piping shall be secured at sufficiently close intervals to keep the pipe in alignment and carry the weight of the pipe and contents.

(b) *Hangers and anchors.* 1. Hangers and anchors shall be of sufficient strength to support their proportional share of the pipe alignments and prevent rattling.

2. Piping shall be securely attached to the structure by proper hangers, clamps, or brackets which provide protection against motion, vibration, road shock, torque in the chassis, or other unusual conditions.

(10) WATER DISTRIBUTION SYSTEM. (a) *Water supply.* 1. Supply piping. Piping systems shall be sized to provide an adequate quantity of water to each plumbing fixture at a flow rate sufficient to keep the fixture in a clean and sanitary condition without any danger of backflow or back-siphonage. See table 29.

2. Hot water supply. Each mobile home equipped with a kitchen sink, and bathtub and/or shower shall be provided with a hot water supply system including a water heater.

(b) *Water outlets and supply connections.* 1. Water connection. Each mobile home with a water distribution system shall be equipped with a $\frac{3}{4}$ inch inlet coupling located within the rear half of the length of the mobile home. This inlet should be located as near as possible to a point 30 feet from the front of the mobile home, and left (road side) of the center line. This connection shall be tagged or marked "Fresh Water Connection" or "Fresh Water Fill". A matching cap or plug shall be provided to seal the water inlet when it is not in use, and shall be attached with a substantial chain.

2. The installation of potable water supply piping or fixture or appliance connections shall be made in a manner to preclude the possibility of backflow or back-siphonage. No part of the water system shall be connected to any drainage or vent piping. Wis. Adm. Code section H 62.14 shall also be applicable.

3. Rim outlets. The outlets of faucets, spouts, and similar devices shall be spaced at least one inch above the flood level of the fixture.

4. Appliance connections. Water supplies connected to clothes washing or dishwashing machines shall be protected by an approved fixed air-gap provided within the appliance by the manufacturer.

5. Flushometer valves or manually operated flush valves. A department approved vacuum breaker shall be installed and maintained in the water supply line on the discharge side of a water closet flushometer valve or manually operated flush valve. Vacuum breakers shall have a minimum clearance of 6 inches above the flood level of the fixture to the critical level mark unless otherwise permitted in their approval.

6. Flush tanks. Water closet flush tanks shall be equipped with an approved anti-siphon ballcock which shall be installed and maintained with its outlet or critical level mark not less than one inch above the full opening of the overflow pipe.

(c) *Water heater safety devices.* 1. Relief valves. All water heaters shall be installed with approved fully automatic valve or valves designed to provide temperature and pressure relief.

2. Any temperature relief valve or combined pressure and temperature relief valve installed for this purpose shall have the temperature sensing element immersed in the hottest water within the upper 6 inches of the tank. It shall be set to start relieving at a pressure not exceeding the rated working pressure of the tank and at or below a water temperature of 210 degrees F.

3. Relief valves shall be provided with full-sized drains and the drain outlets shall be directed downward. When the drain is terminated within the mobile home, the outlet shall be located within 6 inches of the floor. Drain lines shall drain fully by gravity, shall be protected from freezing and plugging, shall not be trapped, nor their outlets threaded.

(d) *Water heaters.* Each storage water heater shall be provided with a $\frac{3}{4}$ inch pipe tapping for a temperature relief valve within the top 6 inches of the tank. The tapping shall be in a location which will permit easy access for installing, testing and maintenance of the valve. This tapping may also be used for a combined pressure temperature relief valve.

(e) *Materials.* 1. Piping material. Water pipe shall be of standard weight brass, galvanized wrought iron, galvanized steel, type K or L copper tubing or other material approved by the department.

2. Fittings. Appropriate fittings shall be used for all changes in direction or size and where pipes are joined. The material and design of fittings shall conform to the type of piping used.

3. Fittings for screw piping shall be standard weight galvanized iron for galvanized iron and steel pipe, and of brass for brass piping. They shall be installed where required for change in direction, reduction of size, or where pipes are joined together.

4. Fittings for copper tubing shall be cast brass or drawn copper sweat solder pattern or flare type.

5. Prohibited material. Used piping materials shall not be permitted. Pipe dope, solder flux, oils, solvents, chemicals, or other substances that are toxic, corrosive, or otherwise detrimental to the water system shall not be used.

(f) *Installation of piping.* 1. Minimum requirement. All piping equipment, appurtenances, and devices shall be installed in workmanlike manner and shall conform with the provisions and intent of this chapter.

2. Screw pipe. Iron pipe size brass or galvanized iron or steel pipe and fittings shall be joined with approved standard pipe threads fully engaged in the fittings. Pipe ends shall be reamed to the full bore of the pipe. Pipe-joint compound shall be insoluble in water, shall be nontoxic and shall be applied to male threads only.

3. Solder fittings. Joints in copper water tube shall be made by the appropriate use of approved cast brass or wrought copper fittings, properly soldered together. The surface to be soldered shall

be thoroughly cleaned bright by mechanical methods. The joints shall be properly fluxed and made with approved solder.

4. Flared fittings. A flaring tool shall be used to shape the ends of flared tubing to match the flare of fittings.

(g) *Size of water supply piping.* 1. Minimum size. The size of water supply piping and branch lines shall not be less than sizes shown in table 29.

Table 29
MINIMUM SIZE TUBING AND PIPE FOR WATER
DISTRIBUTION SYSTEMS*

Number of Fixtures	Tubing		Pipe
	Inside Diameter (Inches)	Outside Diameter (Inches)	Iron Pipe Size Inside Diameter (Inches)
1-----	$\frac{1}{4}$ †	$\frac{3}{8}$	$\frac{1}{2}$
2-----	$\frac{3}{8}$	$\frac{1}{2}$	$\frac{1}{2}$
3-----	$\frac{1}{2}$	$\frac{5}{8}$	$\frac{1}{2}$
4-----	$\frac{1}{2}$	$\frac{6}{8}$	$\frac{3}{4}$
5 or more-----	$\frac{3}{4}$	$\frac{1}{2}$	$\frac{3}{4}$

†6 feet maximum length for $\frac{1}{4}$ inch ID tubing.

*Exceptions to table: $\frac{3}{8}$ inch ID nominal or $\frac{1}{2}$ inch OD minimum size for clothes washing or dishwashing machines, unless larger size is recommended by the fixture manufacturer.

* $\frac{1}{2}$ inch ID nominal or $\frac{3}{4}$ inch OD minimum size for flushometer or metering type valves unless otherwise specified in their listing.

*No galvanized screw piping shall be less than $\frac{1}{2}$ inch inside diameter iron pipe size.

2. Sizing procedure. Both hot and cold water piping systems shall be computed by the following method:

Start at the most remote outlet on any branch of the hot or cold water piping and progressively count towards the water service connection, computing the total number of fixtures supplied along each section of piping. Where branches are joined together, the number of fixtures on each branch shall be totaled so that no fixture is counted twice. Following down the left-hand column of table 29, a corresponding number of fixtures will be found. The required pipe or tubing size is indicated in the other columns on the same line.

3. A water heater or food waste disposal unit shall not be counted as a water-using fixture when computing pipe sizes.

4. Line valves. Valves, when installed in the water supply distribution system (except those immediately controlling one fixture supply) and when fully opened, shall have a cross-sectional area of the smallest orifice or opening, through which the water flows, at least equal to the cross-sectional area of the inside diameter size of the pipe in which the valve is installed.

(11) DRAINAGE SYSTEMS. (a) *Materials.* 1. Piping. Drainage piping shall be standard weight galvanized steel; wrought iron; cast iron; brass; K, M, L, or DWV type copper; ABS or PVC plastic or other materials approved by the department.

a. ABS plastic pipe and fitting materials shall be type 1, grade 2, schedule 40 DWV or heavier, as defined in A.S.T.M. specifications D 1788-68 and D 2661-68. They shall also bear the NSF (National Sanitation Foundation) Seal of Approval for drain, waste and vent systems.

b. PVC plastic pipe and fitting materials shall be type 1, grade 1, schedule 40 DWV or heavier, as defined in A.S.T.M. specifications D 1784-69 and D 2665-68. They shall also bear the NSF (National Sanitation Foundation) Seal of Approval for drain, waste and vent systems.

2. Fittings. Drainage fittings shall be recessed drainage pattern with smooth interior waterways of the same diameter as the piping and shall be of a material conforming to the type of piping used. Drainage fittings shall be designed to provide for a $\frac{1}{4}$ inch per foot grade in horizontal piping.

3. Fittings for screw pipe shall be cast iron, malleable iron, brass, or approved plastic with standard pipe threads.

4. Fittings for copper tubing shall be cast brass or wrought copper.

5. Socket-type fittings for plastic piping shall comply with standards approved in this section.

6. Brass or bronze adaptor or wrought copper fittings shall be used to join copper tubing to threaded pipe.

(b) *Drain outlets.* 1. Location of drain. Each mobile home shall have only one drain outlet which shall terminate in the rear half section. This outlet should be located as close as possible to a point 40 feet from the front of the mobile home.

2. Clearance from drain outlet. The drainage outlet and couplers shall be provided with a minimum clearance of 3 inches in any direction from all parts of the structure or appurtenances and with not less than 18 inches unrestricted clearance directly in front of the drainage outlet.

(c) *Hose couplers and caps.* 1. Hose couplers for drain outlets shall be a quick disconnect type not requiring any special tools or knowledge to make the connection or remove the drain hose.

2. Hose couplers and drain connectors shall not be smaller than the piping to which they are connected and shall be equipped with a watertight cap or plug matching the drainage outlet or coupler. The cap or plug shall be permanently attached to the structure by means of a substantial chain.

3. Drain outlet or attached drain connectors for drain piping connected to a mobile home shall be 3 inches minimum inside diameter.

4. Preassembly of drain lines. Drain lines, provided by the manufacturer, located under the mobile home, designed to bring the drain system to one distribution point and which may be damaged in transit, must be designed for proper site assembly.

5. Fixture connections. Drainage piping shall be provided with approved inlet fittings for fixture connections, correctly located according to the size and type of fixture to be connected.

6. Water closet connection. The drain connection for each water closet shall be 4 inches minimum inside diameter. The 4 inch soil pipe shall be fitted with an iron, brass, or approved plastic floor flange adaptor ring securely screwed, soldered or otherwise permanently attached to the drain piping, in an approved manner and securely fastened to the floor.

(d) *Size of drainage piping.* 1. Fixture load. The number of fixture units connected to any stack or branch or vent and the size and length of piping shall not exceed that shown in tables 1 and 2, Wis. Adm. Code section H 62.03.

2. Wet vented drainage system. Plumbing fixture traps may connect into a wet vented drainage system which shall be designed and installed to accommodate the passage of air and waste in the same pipe.

3. Horizontal piping. All parts of a wet vented drainage system, including the connected fixture drains, shall be horizontal except for wet vented vertical risers which shall terminate with a 1½ inch minimum inside diameter continuous vent. Where required by structural design, wet vented drain piping may be offset vertically when other vented fixture drains or relief vents are connected to the drain piping below the vertical offsets.

4. Size. A wet vented drain pipe shall be 2 inches minimum inside diameter and at least one pipe size larger than the largest connected trap or fixture drain. Not more than one fixture may connect to a 2 inch inside diameter wet vented drain system. See section H 62.16 (12) (f).

5. Length of trap arm. Fixture traps shall be located within the distance given in table 28, section H 62.16 (6) (h). Not more than one trap shall connect to a trap arm except for two compartment sinks which are considered as one fixture.

(e) *Offsets and branch fittings.* 1. Changes in direction. Changes in direction of drainage piping shall be made by the appropriate use of approved fittings, and shall be of the following angles: 11¼, 22½, 45, 60, or 90 degrees; or other approved fittings or combination of fittings with equivalent radius or sweep.

2. Horizontal to vertical. Horizontal drainage lines, connecting with a vertical pipe shall enter through 45 degree "Y" branches, 60 degree "Y" branches, long-turn "TY" branches, sanitary "T" branches, or other approved fittings or combination of fittings having equivalent sweep. Fittings having more than one branch at the same level shall not be used unless the fitting is constructed so that the discharge from any one branch cannot readily enter any other branch. However, a double sanitary "T" may be used when the drain line is increased not less than two pipe sizes.

3. Horizontal to horizontal and vertical to horizontal. Horizontal drainage lines connecting with other horizontal drainage lines or vertical drainage lines connected with horizontal drainage lines shall enter through 45 degree "Y" branches, long-turn "TY" branches, or other department approved or combination of fittings having equivalent sweep.

4. Slope of horizontal drainage piping. Horizontal drainage piping shall be run in practical alignment and have a uniform slope of not less than ¼ inch per foot toward the mobile home drain outlet. Where it is impractical, due to the structural features or arrangement of any mobile home, to obtain a slope of ¼ inch per foot, the pipe or piping may have a slope of not less than ⅓ inch per foot, when a full size cleanout is installed at the upper end.

(12) VENTS AND VENTING. (a) *General.* Each plumbing fixture trap shall be protected against siphonage and back pressure, and air circulation shall be ensured throughout all parts of the drainage system by means of vents installed in accordance with the requirements of this section.

(b) *Back vent.* A back vent or continuous vent pipe shall be provided to serve each trap except as otherwise specified in this chapter.

(c) *Crown vent.* In no case shall a vent be connected to the crown of a trap.

(d) *Main soil or waste vent.* Every mobile home having plumbing fixtures or a plumbing system shall have installed therein at least one main soil or waste vent (stack vent) of at least 2 inches inside diameter.

(e) *Unit vent.* Two identical fixtures located on the same floor level discharging through the same approved drainage pattern fitting into a vertical soil or waste pipe may be served by a unit vent pipe as hereafter indicated. (Also referred to as a common vent.)

(f) *Wet vent.* Fixtures with a unit value of only one or less may be used to wet vent floor outlet fixtures located on the same floor level as the fixture creating the wet vent.

(g) *Vent installation.* 1. Vent relocation. Where fixtures are afterwards installed on a soil or waste pipe above existing vent connections to the main soil or waste vent, the vent piping system shall be rearranged to conform to the provisions of this chapter.

2. Vent pipe grades. All vent pipes shall be free from drops or sags and shall be so graded and connected as to drain back to the soil or waste pipe by gravity. Whenever it becomes necessary to trap a horizontal vent pipe, it shall be drained back into a waste pipe by gravity with a 1½ inch minimum inside diameter drip pipe.

3. Vent connections. All vent pipes shall be run separately through the roof, be connected to other vent pipes or vent stacks a minimum of 4 inches below the roof, or be reconnected to the main vent pipe not less than 38 inches above the highest floor on which fixtures are installed. All changes in direction from vertical to horizontal on any vent shall be made above the overflow rim of the fixture, but not less than 36 inches above the floor wherever possible. No fitting or fittings for future waste connections shall be placed in any soil or waste pipe above the point of revent connection.

4. Alternate venting systems. Design of venting arrangements other than set forth in this section shall be submitted to the department for approval prior to installation.

5. Materials. Vent piping shall be standard weight galvanized steel; wrought iron; cast iron; brass; K, M, L, or DWV type copper; ABS or PVC plastic; or other materials approved by the department.

a. ABS plastic pipe and fitting materials shall be type 1, grade 2, schedule 40 DWV or heavier, as defined in A.S.T.M. specifications D 1788-68 and D 2661-68. They shall also bear the NSF (National Sanitation Foundation) Seal of Approval for drain, waste and vent systems.

b. PVC plastic pipe and fitting materials shall be type 1, grade 1, schedule 40 DWV or heavier as defined in A.S.T.M. specifications D 1784-69 and D 2665-68. They shall also bear the NSF (National Sanitation Foundation) Seal of Approval for drain, waste and vent systems.

c. Fittings. Appropriate fittings shall be used for all changes in direction or size and where pipes are joined. The material and design of vent fittings shall conform to the type of piping used.

d. Fittings for screw pipe shall be cast iron, malleable iron, plastic, or brass, with standard pipe threads.

e. Fittings for copper tubing shall be cast brass or wrought copper.

f. Brass adaptor or wrought copper fittings shall be used to join copper tubing to threaded pipe.

(h) *Vent terminal.* 1. Roof extension. Each soil, waste or vent stack shall be increased to at least 4 inches inside diameter or terminate with a department approved frostproof flashing. No vent shall terminate less than 2 inches above the roof. Vent openings shall not be less than 3 feet from any motor driven air intake that opens into habitable areas.

2. Flashing. The opening around each vent pipe shall be made watertight by an adequate flashing or flashing material.

(13) TEST AND INSPECTION. (a) *Water system.* All water piping in the water distribution system shall be subjected to a pressure test before any portion is covered or concealed. The test shall be made by subjecting the system to air or water at 100 psi for 15 minutes without leakage or loss of pressure. An adequate and accurate pressure gauge shall be used on all tests.

(b) *Drainage and vent system and plumbing fixtures.* The waste and vent system shall be tested by one of the following methods for evidence or indication of leakage.

1. Water test. Before plumbing fixtures are connected, all of the openings into the piping shall be plugged and the entire piping system subjected to a static water test for 5 minutes by filling it with water to the highest opening above the roof. There shall be no evidence of leakage.

2. Air test. After all fixtures have been installed, the traps filled with water, and the remaining openings securely plugged, the entire system shall be subjected to a 2 inch (manometer) water column air pressure test. If the system loses pressure, leaks may be located with smoke pumped into the system, or with soap suds spread on the exterior of the piping (bubble test).

(c) *Flood level test.* The mobile home shall be in a level position, all fixtures shall be connected, and the entire system shall be filled with water to the rim of the water closet bowl. (Tub and shower drains shall be plugged.) After all trapped air has been released, the test shall be sustained for not less than 5 minutes without evidence of leaks. Then the system shall be unplugged and emptied. The waste piping above the level of the water closet bowl shall then be tested and show no indication of leakage when the high fixtures are filled with water and emptied simultaneously to obtain the maximum possible flow in the drain piping.

(d) *Fixture test.* The plumbing fixtures and connections shall be subjected to a flow test by filling them with water and checking for leaks and retarded flow while they are being emptied.

(e) *Shower stalls.* Nonmetallic shower stalls and receptors shall be tested for leaks prior to being covered by finish material. Each pan shall be filled with water to the top of the dam for not less than 15 minutes.

Note: Copies of standards promulgated by the following technical societies referred to above are on file in the offices of secretary of state, health and social services and revisor of statutes and may be obtained for personal use from the following addresses:

American National Standards Institute, Inc.
1430 Broadway, New York, New York 10018

American Society for Testing and Material
1916 Race St., Philadelphia, Pa. 19103

National Sanitation Foundation
Testing Laboratory, Inc., P. O. Box 1468
Ann Arbor, Michigan 48106

History: 1-2-56; r. and recr. (1) and (2), Register, August, 1961, No. 68, eff. 9-1-61; r. and recr. Register, November, 1972, No. 203, eff. 12-1-72.

H 62.17 Mobile home parks. (1) **PLAN APPROVAL.** (a) *Plans and specifications.* Complete plans and specifications shall be submitted to the department and written approval received before letting contracts or commencing work for all mobile home park sewerage, mobile home park water main and water services and for the addition to or replacement of existing systems.

(b) *Local approval.* The approval by county or other local governmental agency shall not exempt the requirements for state approval for the installation of sewerage and water systems serving mobile home parks.

(c) *Submission of plans and specifications.* All plans and specifications shall be submitted in triplicate and shall include the following:

1. Detailed plan of the proposed sewerage and water system showing mobile home site and service building location with all building sewers and water services indicated.

2. Legal description of the property on which the park is to be constructed.

3. Availability of plans. There shall be maintained at the project site one set of plans bearing the department's stamp of approval.

4. Plans and specifications submitted for private sewage disposal systems shall meet the criteria set forth in Wis. Adm. Code section H 62.20.

(2) **MOBILE HOME PARK SEWERAGE SYSTEM.** (a) *General.* The park main sewerage system shall be constructed of materials approved by the department, and installed to limit infiltration of surface or subsoil waters. The infiltration of surface or subsurface waters shall not exceed 200 gallons per inch of diameter per mile per day. See Wis. Adm. Code section H 62.23 (2) (h).

(b) *Design and construction.* 1. Main sewer size and gradient. The main sewers shall be sized and graded in accordance with table 30. Main sewers 8 inches or larger shall be designed and constructed to give mean velocity, when flowing full, of not less than 2.0 feet per second, based on Kutter's formula using an "n" value of 0.013. Use of other practical "n" values may be permitted by the department, if deemed justifiable on the basis of research or field data presented.

Table 30

Inside Diameter of Pipe (inches)	Maximum Number Mobile Homes		
	$\frac{1}{8}$ " per ft. slope	$\frac{1}{8}$ " per ft. slope	$\frac{1}{4}$ " per ft. slope
4	None	7	10
6	12	13	24
8	26	34	49

Mobile home parks containing 50 or more homes or sites shall have a minimum 8 inch sewer main.

2. Sewer installation construction shall comply with Wis. Adm. Code section H 62.04.

(c) *Manholes*. A manhole or cleanout shall be installed at the end of each line. Manholes shall be installed at all changes in gradient, size, or alignment; at all intersections; and at distances not greater than 400 feet.

1. Diameter. The minimum diameter of manholes shall be 42 inches.

2. Water tightness. Solid manhole covers shall be used. Manholes of brick or segmented block shall be waterproofed on the exterior by partering with a cement mortar.

3. Terminal manhole. The park sewerage system shall connect to one or more terminal manholes from which the park sewerage system shall extend to a municipal sewerage system or an approved private domestic sewage disposal system. See "Typical Sewerage and Vent System" sketch.

(d) *Cleanouts*. Cleanouts shall comply with the following specifications:

1. All cleanouts shall extend at least 4 inches above established grade.

2. Size. See Wis. Adm. Code section H 62.10 (2).

3. Location. Cleanouts shall be installed with a maximum distance of 100 feet between cleanouts or 200 feet between cleanout and manhole.

4. Protection. Cleanouts shall be surrounded by a concrete slab at least 4 inches thick extending at least 9 inches on all sides, sloping away from the cleanout.

(e) *Mobile home building sewer*. 1. Storm and clear water connections to the park sanitary sewerage system are prohibited. See Wis. Adm. Code section H 62.04 (8) (c).

2. Building sewers—mobile homes. a. Each mobile home site shall be provided with a minimum 4 inch inside diameter building sewer which shall terminate with a 4 inch inside diameter P trap. The trap shall be located within the immediate boundary lines of the pad occupied by the mobile home. Each trap inlet connection shall extend at least 4 inches above final grade and be encased in a concrete pad measuring not less than 4 inches in thickness and 18 inches square. The building sewer shall extend full size to the trap connection which shall be provided with a back vent or a circuit vent. Each trap inlet connection shall be effectively capped or plugged when not in use.

b. Back venting. The developed distance of the horizontal building sewer shall not exceed 48 times the inside diameter of the pipe from the point of vent to the trap weir. See following sketch.

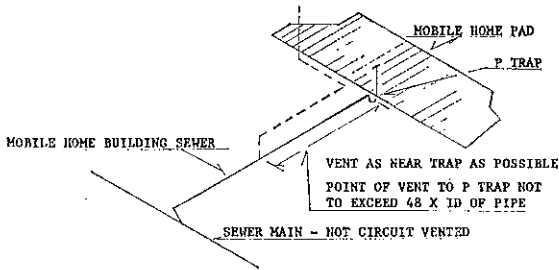

c. Circuit venting. Circuit vents for mobile home P traps shall have a minimum diameter of 4 inches. The size of the circuit vent shall be determined by table 31. Circuit vents shall be constructed as specified in Wis. Adm. Code section H 62.07 (2), except the number of units served shall be determined by table 31. Also, see sketch indicating typical mobile home park sewerage and vent system.

Table 31

Diameter of vent pipe (inches)	Maximum number of mobile homes served by circuit vent
4	15
5	30
6	50

d. Vent terminals. Vents shall terminate either a minimum of 12 inches above the mobile home or not less than 25 feet from any mobile home and terminate with a return bend at least 18 inches above final grade. See following sketch.

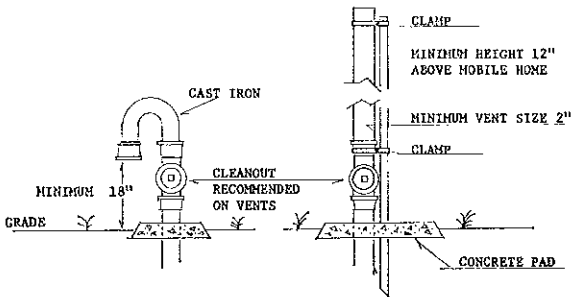

e. Mobile home drain connector. The piping between the soil or waste outlet of the mobile home to the building sewer shall have a minimum pitch of $\frac{1}{4}$ inch per foot, be as short as possible, and made gastight and watertight with rigid or semi-rigid approved materials. All piping should be protected against freezing.

TYPICAL MOBILE HOME PARK SEWERAGE AND VENT SYSTEM

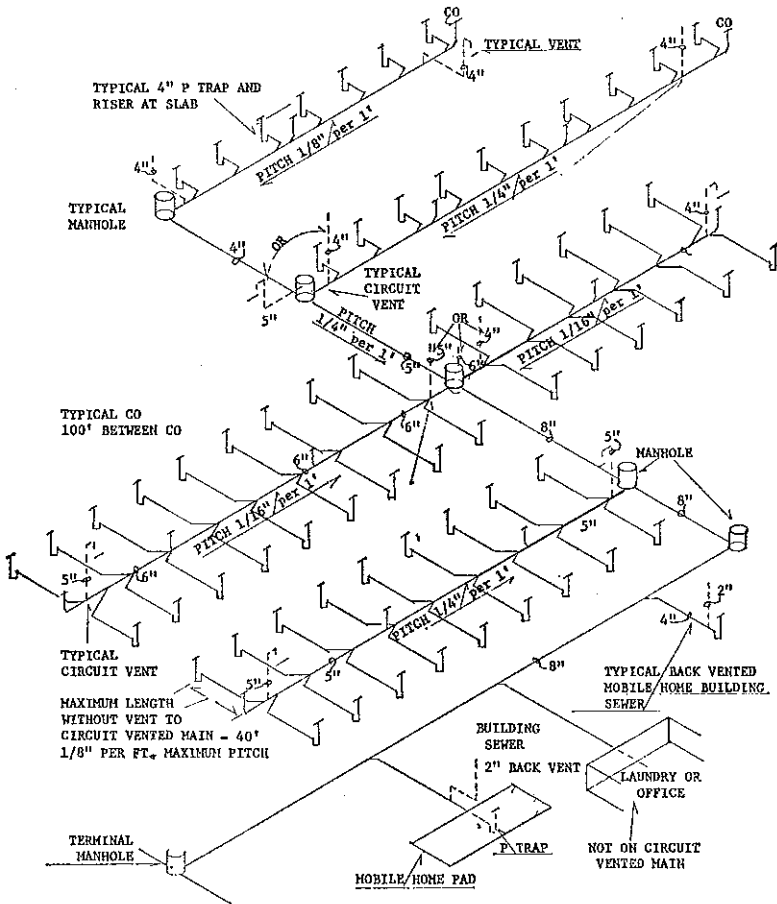

(3) PARK WATER DISTRIBUTION SYSTEM. (a) *General*. An adequate supply of potable water shall be supplied to each mobile home site. The minimum pressure within the park distribution main shall be sufficient to maintain 20 psi at each mobile home site. All water distribution mains shall be installed at a depth to prevent freezing.

(b) *Water distribution main*. 1. *Materials*. Water distribution mains shall be type K copper, lead, brass, asbestos cement, cast iron water pipe, galvanized wrought iron, galvanized open hearth iron, galvanized steel, plastic or other materials approved by the department. Any of the above materials used shall be acceptable to the local or municipal water utility.

2. *Valving*. Water distribution mains shall be provided with a gate or full flow valve at its source and at each branch connection.

Such valves shall be accessible for operation by installing in valve manholes or stop boxes.

3. Water and sewer separation. See Wis. Adm. Code section H 62.13 (2).

(c) *Mobile home water service.* 1. Size. Every mobile home site shall be served by a separate water service not less than $\frac{3}{4}$ inch inside diameter.

2. Materials. Materials shall meet the requirements of Wis. Adm. Code section H 62.13 (2) (b).

3. Valving. Each water service shall be provided with: a corporation valve at the main, a curb stop and box located at the site lot line of the parking pad, and a $\frac{3}{4}$ inch inside diameter valve located on the upper end of the water service riser pipe. The water service riser and valve shall extend at least 6 inches above established grade. Underground stop and waste valves are prohibited.

4. Optional riser valves. An approved freezeless type of hydrant with a minimum outlet of $\frac{3}{4}$ inch inside diameter for connection to the mobile home water supply inlet may be used. It shall extend at least 6 inches above the established surface and be protected by a concrete pad at least 4 inches in thickness with an apron extending at least 9 inches on all sides, sloped so that all surface water will drain away from it.

5. Depth of water service and valves. All water service piping shall be protected against freezing.

6. Connection of water service to mobile home. Connection of the mobile home water distribution piping system to the water service riser pipe shall be made with approved materials.

(4) LOCATION OF SEWER INLET AND WATER SERVICE RISER PIPING. The building sewer and water service riser pipes shall terminate in concrete pads located to one side of the rear third of the length of the mobile home hard stand or pad. The water service riser shall extend at least 6 inches above established grade. Each building sewer trap inlet riser shall be encased in a concrete pad measuring not less than 4 inches in thickness and 18 inches square. Each trap inlet connection shall extend not less than 4 inches above final grade and not exceed the elevation of the water service riser valve. See following sketch.

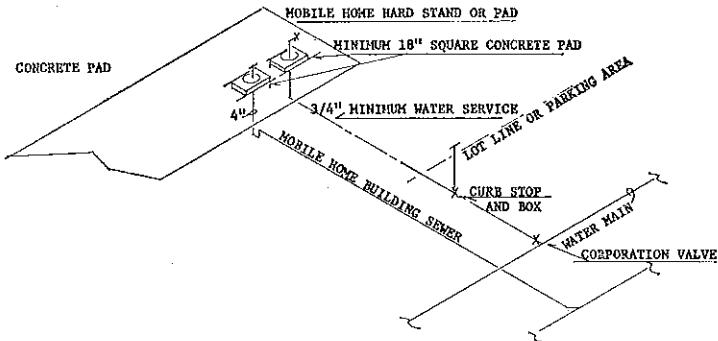

History: 1-2-56; r. and recr. Register, November, 1972, No. 203, eff. 12-1-72.

Register, November, 1972, No. 203

H 62.18 Joints and connections. (1) **TIGHTNESS.** Joints and connections in the plumbing system shall be watertight and gastight for the pressure required by test or system design, whichever is greater, with the exception of perforated or open joint piping which is installed for the purpose of collecting and conveying groundwater, seepage water or septic tank effluent to the point of disposal.

(2) **TYPES OF JOINTS.** (a) *Asbestos cement pipe joints.* Asbestos cement pipe joints shall be made with a sleeve type coupling of the same material as the pipe and sealed with 2 rubber rings.

(b) *Bituminized fiber pipe joints.* Bituminized fiber pipe joints shall be made with tapered type couplings of the same material as the pipe or equal.

(c) *Borosilicate glass pipe joints.* Borosilicate glass pipe joints shall be made with a bolt compression type stainless steel (300 series) coupling with contoured Buna-N resilient compression ring and a fluorocarbon inner seal ring.

(d) *Joints on brass pipe.* Joints on brass pipe shall conform to the provisions of section H 62.18 (2) (i) except that exposed threads do not require coating.

(e) *Cast iron pipe.* 1. Joints in cast iron bell and spigot soil, waste and vent pipe shall be made by first inserting a roll of hemp, oakum or jute and thoroughly caulking in place, and then filled with pure molten lead to a depth of not less than one inch. The lead shall be caulked thoroughly at the inside and outside edges of the joint. No paint, varnish or other coatings shall be permitted on the jointing material until after the joints have been tested.

2. Rubber gasket joints in bell and spigot cast iron pipe made by means of a preformed molded rubber ring, secured by pulling the pipe and fittings together in such a way as to compress the molded rubber ring in a manner that will assure a gastight and watertight joint are permitted in underground building sewers and underground building drains. The rubber sealing ring shall conform to A.S.T.M. C-564-70.

3. Joints in cast iron water pipe shall be lead caulked bell and spigot, mechanical joint bell and spigot or push-on bell and spigot conforming to A.W.W.A. C600-64 specifications section 9a, 9b or 9c. When mechanical joint or push-on joints are installed, bonding provision shall be made for electrical thawing.

(f) *Cement mortar joints.* Cement mortar joints are prohibited except for repairs and connections to existing piping installed with such joints. When permitted, cement mortar joints shall be made in the following manner: A layer of jute or hemp shall be inserted into the base of the annular joint space and packed tightly to prevent mortar from entering the interior of the pipe or fitting. Not more than 25% of the annular space shall be used for jute or hemp. The remaining space shall be filled in one continuous operation with a thoroughly mixed mortar composed of one part cement and 2 parts sand with only sufficient water to make the mixture workable by hand. Additional mortar of the same composition shall then be applied to form a 1 to 1 slope with the barrel of the pipe. The bell or hub of the pipe shall be left exposed. When necessary, the interior of the pipe shall be swabbed to remove any mortar or other material which may have found its way into the pipe or fitting.

(g) *Joints in concrete pipe.* Joints in concrete pipe shall be made with rubber type gaskets and conform to A.S.T.M. "Specifications for Joints for Circular Concrete Sewer and Culvert Pipe, Using Flexible, Watertight, Rubber Gaskets", designation C 443-67. For building sanitary sewers, they shall be of an oil resistant type having a maximum swell of 90% when tested in accordance with A.S.T.M. designation D 471-72 in A.S.T.M. Oil No. 3.

(h) *Copper tube and fittings.* 1. Joints for copper tube for soil, waste and vent piping shall be soldered or sweated. The surfaces to be soldered or sweated shall be cleaned bright, properly fluxed and soldered or sweated with noncorrosive 50-50 lead-tin (new metals) or tin-antimony containing 90 to 96% tin and 4 to 10% antimony (95-5).

2. Joints for copper water tube may be soldered, flared or flanged provided that all aboveground water tube which will be concealed shall be soldered or sweated. The process for soldering or sweating shall be as specified in section H 62.18 (2) (h) 1. Flared joints, permitted with soft copper, shall be made by the use of a proper flaring tool. Silver soldering will be permitted only on copper water tube installed underground.

(i) *Wrought iron and steel pipe and fittings.* 1. Joints in wrought iron and steel pipe and fittings shall be standard taper pipe thread. All burrs shall be removed. Pipe ends shall be reamed or filed out to full size of bore and all chips removed. All screw joints shall be made with mineral paint or pipe thread compound which is insoluble in water and nontoxic, applied to the male thread.

2. Welded joints are permitted only on black wrought iron or steel pipe aboveground in rainwater conductors with weld type fittings. Mitered joints are prohibited, Joints to be welded shall be free from rust, paint, oil, scale or other objectionable material and the welding performed in accordance with acceptable procedure.

(j) *Hot poured joints.* Hot poured compound joints are prohibited except for repair or replacement where it is impractical to use any other jointing method. Hot poured compound for clay or concrete sewer pipe shall not be water absorbent and when poured against a dry surface shall have a bond of not less than 100 pounds per square inch in shear. All surfaces of the joint shall be cleaned and dried before pouring. If wet surfaces are unavoidable, a suitable primer shall be applied. The compound shall not soften sufficiently to destroy the effectiveness of the joint when subjected to a temperature of 160 degrees F. nor be soluble in any of the waste carried by the drainage system. Approximately 25 per cent of the joint space at the base of the socket shall be filled with jute or hemp. A pouring collar, rope or other device shall be used to hold the hot compound during pouring. Each joint shall be poured in one operation until the joint is filled. Joints shall not be tested until one hour after pouring.

(k) *Wiped joints.* Wiped joints in lead pipe shall have an exposed surface on each side of the joint not less than $\frac{3}{4}$ inch and a minimum thickness at the thickest part of the joint of not less than $\frac{3}{8}$ inch.

(l) *Joints in vitrified clay pipe.* Joints in vitrified clay pipe shall be prefabricated of resilient materials, bonded to the pipe at the pro-

ducing plant. The resilient materials shall conform to the A.S.T.M. "Specifications for Compression Joints for Vitrified Clay Bell and Spigot Pipe," Designation C425-71. Only virgin materials shall be used. The composition of the jointing material shall be periodically checked after fabrication by an accredited laboratory. Prior to making the installation, the joint material on both the bell and spigot ends shall be wiped clean and coated with a lubricant. The spigot end shall be inserted into the bell and pressure applied until the pipe is properly seated.

(3) JOINTS BETWEEN DIFFERENT PIPING MATERIALS. Refer to either material in this section.

(a) Asbestos cement pipe. See material to which it is to be joined.

(b) Bituminous fiber. Joints between bituminous fiber and asbestos cement or concrete pipe shall be made by means of a department approved adapter.

(c) 1. Joints between brass, wrought iron or steel and copper or lead shall be made by the use of a copper or brass adapter with standard screw threads.

2. Joints between wrought iron or steel and glass pipe shall be made by the use of a department approved adapter.

(d) 1. Joints between cast iron soil pipe and asbestos cement or bituminous fiber pipe shall be made by the use of a proper adapter and a caulked joint conforming to section H 62.18 (2) (e) 1.

2. Joints between cast iron, copper, brass or steel pipe shall be made by the use of a screw thread joint or ferrule and lead caulked joints except a ferrule will not be required when steel pipe and cast iron are of the same diameter.

(e) Joints between vitrified clay tile and asbestos cement, bituminous fiber or cast iron pipe shall be made by the use of a department approved adapter.

(f) Joints between concrete pipe or fittings and asbestos cement, cast iron, vitrified clay, borosilicate glass or lead pipe shall be made by the use of department approved adapters.

(g) 1. Joints between copper tube and vitrified clay or concrete pipe shall be made by soldering or sweating a ferrule or hub onto the copper tube and the use of a department approved adapter.

2. Joints between copper tube and glass pipe shall be made by the use of a copper to American National taper pipe thread adapter and a glass manufacturer's conversion connection.

3. Joints between borosilicate glass and vitrified clay pipe shall be made by acid resistant oakum or hemp and department approved sealing compound.

(h) 1. Joints between borosilicate glass pipe and cast iron bell and spigot or lead pipe shall be made with department approved adapters except a lead caulked joint may be used to join spigot end glass pipe to hub end cast iron pipe of the same diameter.

2. Joints between copper tube and lead pipe shall be made by the use of threaded lead ferrules and screw thread copper or brass adapters.

(i) Joints between lead and cast iron pipe shall be made by means of a wiped joint to a caulking ferrule and lead caulked joint.

(j) Joints between plastic pipe and pipe or fittings of other materials shall be made by the use of department approved adapters.

(4) SPECIAL JOINTS. (a) Slip joints. Slip joints using packing or gasket material may be used on the inlet side of a trap or within the dip of the trap, but are prohibited on the sewer side of the trap. See following sketch.

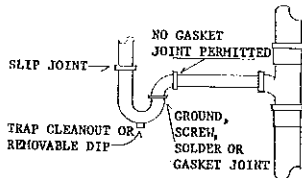

(b) Ground joints. Brass or copper ground faced ferrule type connections which allow adjustment of tubing but provide a rigid joint when made up may be used on the discharge side of a brass tube trap or a fixture water supply but may not be concealed.

(c) Ground faced unions of drainage pattern may be used in waste piping but may not be concealed.

(d) Adapters with IPS thread with caulking hub are permitted in soil, waste and vent piping provided the caulked joint is made in a vertical position.

(e) 1. Fixture connections between drainage pipes and water closets, floor outlet service sinks, wall mounted urinals and earthenware trap standards, shall be made by means of brass, hard lead, or iron flanges soldered, caulked or screwed to the drainage pipe. The connection shall be bolted with an approved gasket, washer or setting compound between the earthenware and the connection. For floor outlet fixtures, the bottom of the flange shall be set on top of the finished floor on a firm base.

2. Wall mounted water closets and wall mounted urinals shall be securely bolted to a carrier fitting. The connecting piping between the carrier fitting and the fixture shall be an approved metal and designed to accommodate an adequately sized gasket. The gasket material shall be graphite impregnated asbestos, felt or similar approved type.

(5) PROHIBITED JOINTS AND CONNECTIONS. (a) *Drainage system.*

1. Any fitting or connection which has an enlargement, chamber or recess with a ledge, shoulder or reduction of pipe area that offers an obstruction to flow through the drains is prohibited.

2. No fitting or connection that offers abnormal obstruction to flow shall be used. The enlargement of a 3 inch closet bend to 4 inch shall not be considered an obstruction.

3. Where different sizes of pipes or pipes and fittings are to be connected, the proper size adapters, increasers, reducers or reducing fittings shall be used between the two sizes. Hexagon screwed bushings shall not be used in drainage piping.

(6) WATERPROOFING OF OPENINGS. Joints at the roof around vent pipes shall be made watertight by the use of lead, copper, galvanized iron flashings or flashings of other material approved by the department.

Note: Copies of standards promulgated by the following technical societies referred to above are on file in the offices of secretary of state, health and social services and revisor of statutes and may be obtained for personal use from the following addresses:

American Society for Testing and Material
1916 Race St., Philadelphia, Pa. 19103
American Water Works Association
2 Park Avenue, New York, New York 10016

History: 1-2-56; r. and recr. (2) (f), Register, October, 1968, No. 154, eff. 11-1-68, r. and recr. Register, November, 1972, No. 203, eff. 12-1-72.

H 62.19 Materials. (1) **MINIMUM STANDARDS.** (a) Unless otherwise provided for in this chapter, all materials, fixtures or devices sold, used or entering into the construction of plumbing systems or parts thereof, shall be submitted to the department for approval and shall conform to approved applicable standards or to other equivalent standards acceptable to the department and shall be free from defects.

(b) Each length of pipe and each pipe fitting, trap, fixture material and device used in a plumbing system shall have cast, embossed, stamped, or indelibly marked on it the maker's mark or name, the weight and quality of the product or identified in accord with the applicable approved standard. All materials and devices used in the construction of a plumbing system or parts thereof shall be marked and identified in a manner satisfactory to the department.

(c) Standards listed or referred to in this section cover materials which will conform to the requirements of this chapter when used in accordance with the limitations imposed in this or other sections thereof. Designs and materials for special conditions or materials not provided for herein may be used only after the department has been satisfied as to their adequacy and granted approval. Table 32 contains generally accepted and department approved plumbing materials and their applicable standards. See Wis. Adm. Code section H 62.24.

(d) In existing buildings or premises in which plumbing installations are to be altered, repaired or renovated, the department has discretionary powers to permit deviation from the provisions of this chapter provided that such a proposal to deviate is first submitted to the department for proper determination and approval.

(e) The department may require tests to be made or repeated if, at any time, there is reason to believe that any material or device no longer conforms to the requirements on which its approval was based.

(2) **MATERIAL STANDARDS.** (a) *Specification standards.* Each material listed in table 32 shall conform to at least one of the standards opposite it. Products conforming to one or more of the specifications listed shall be considered acceptable subject to limitations specified. See Wis. Adm. Code section H 62.02 (119) for list of abbreviations. For materials not listed, consult the department.

1. Standard strength clay sewer pipe shall not be installed at a depth exceeding 12 feet. See Wis. Adm. Code sections H 62.04 (2) and H 62.05 (2).

2. Extra strength concrete pipe in sizes 6 inch through 10 inch for sewers laid at a depth of less than 12 feet. Concrete pipe 12 inches and larger shall be reinforced concrete. See Wis. Adm. Code sections H 62.04 (2) and H 62.05 (2).

Table 32

Materials	See Limitations of Subsection H 62.19 (2) (a) Below	Standards and Specifications		
		ANSI	ASTM	Other
Asbestos cement—pressure pipe class 150 and class 200.....			C296-69a	AWWA C400-65
Asbestos cement—nonpressure sewer pipe 8 inch and larger.....			C423-71	
Asbestos cement—nonpressure sewer pipe 4, 5 and 6 inch.....			C644-71	
Asbestos cement—storm sewer pipe.....	14		C663-70	
Asbestos cement—perforated pipe—general drainage.....			C908-67	
Bituminous fiber sewer pipe—homogeneous.....			D1861-69	
Bituminous fiber—homogeneous perforated pipe—general drainage.....			D1862-64	
Bituminous fiber—homogeneous perforated pipe—septic tank tile fields.....			D2311-69	
Bituminous fiber—laminated pipe—general drainage.....			D2312-69	
Bituminous fiber—laminated pipe—septic tank tile fields.....			D2417-69	
Bituminous fiber—perforated pipe—glazed.....			D2313-65	
Clay sewer pipe—standard strength—unglazed.....	1		C18-69	
Clay sewer pipe—extra strength—glazed.....	1		C18-69	
Clay sewer pipe—extra strength—unglazed.....	1		C200-69	
Clay pipe—perforated—footing and foundation drains.....	1		C200-69	
Clay drain tile.....			C211-69 1	
Concrete sewer pipe—non-reinforced.....	2		C4-62	
Concrete sewer pipe—reinforced.....	2		C74-67	
Concrete—perforated pipe.....			C74-67	
Concrete—drain tile.....			C444-68	
Corrugated iron or steel pipe.....	13		C412-71	
Cast iron soil pipe and fittings—service and extra heavy.....	3 & 4			F. S. WWP-405a-1968
Cast iron soil pipe and fittings—No-Hub.....	5		A74-69	Cast Iron Soil Pipe Institute 301-72
Cast iron threaded drain, waste and vent fittings.....				
Cast iron soil pipe—threaded.....	6	B16.12-1965		
Cast iron water pipe—cast in metal molds.....		A40.5-1943		
Cast iron water pipe—cast in sand lined molds.....				AWWA C106-62
Cast iron water pipe pressure fittings.....				AWWA C108-62
Cast iron pipe flanges and flanged fittings.....				AWWA C110-64
Cast iron water pipe fittings screwed.....		B16.4-1963		AWWA C110-64
High silicon cast iron soil pipe and fittings.....				
Wrought iron pipe.....			A74-69	
Welded and seamless steel pipe.....			A72-68	
			A59-71a	
			A120-71	

Table 32 (Continued)

Materials	See Limitations of Specification H 62.13 (2) (a) Below	Standards and Specifications		
		ANSI	ASTM	Other
Malleable iron fittings.....		B16.3-1963		
Steel pipe flanges and fittings.....		B16.5-1968		
Nipples threaded.....				See section H 62.19 (1) (a) and (c), Wis. Adm. Code
Wrought seamless copper and copper alloy pipe and tube—general requirements.....	7		B253-68a	
Copper pipe—seamless.....	7		B42-66	
Copper pipe—threadless (TP).....	7		B302-66a	
Copper tube—seamless—types K-L-M.....	7		B88-66a	
Copper drainage tube—type DWV.....	7		B306-66a	
Copper tube—seamless.....	7		B75-68	
Cast bronze screwed fittings 125 & 250 lbs.....		E16.15-1964		
Cast bronze solder joint pressure fittings.....		E16.18-1968		
Cast bronze solder joint drainage fittings.....		E16.23-1969		
Bronze flanges & flanged fittings.....	8	E16.24-1982		
Wrought copper and bronze solder joint pressure fittings.....		E16.22-1968		
Wrought copper and bronze solder joint drainage fittings.....	8	E16.29-1966		
Seamless red brass pipe.....			B43-66	
Seamless brass tube.....			B135-67	
Brass fittings for flared copper tube.....		E16.26-1958		
Acrylonitrile-butadiene-styrene (ABS) Type 1, Schedule 40, DWV and building sewer.....	9		D1738-68	NSF 14
Acrylonitrile-butadiene-styrene (ABS) (water service).....			D2651-68	
	10		D1527-68	NSF 14
			D2382-68	
Polybutylene (water service).....	10		D2632-68	NSF 14
			D2666-68T	
Polyethylene (PE) (water service).....	10		D2104-68	NSF 14
			D2289-68	
Polyvinyl chloride (PVC) (water service).....	10		D2241-69	NSF 14
			D1785-68	
Polyvinyl chloride (PVC).....	9		D2665-68	NSF 14
Schedule 40 unthreaded.....				
Schedule 80 can be threaded.....				
DWV and building sewer.....				

Table 32 (Continued)

Materials	See Limitations to Subsection H 62.19 (2) (a) Below	Standards and Specifications		
		ANSI	ASTM	Other
Solvent cement for acrylonitrile-butadiene-styrene (ABS) plastic pipe and fittings.	9		D2235-67	
Solvent cement for polyvinyl chloride (PVC) plastic pipe and fittings.	9		D2564-67	
Atmospheric vacuum breakers.				ASSE 1001
Caulking materials (water).				AWWA C600-64
Cement lining for cast iron pipe.				AWWA C104-64
Coal tar enamel (protective coating).		B16.4-1963		AWWA C203-66
Ferrous plugs, bushings and locknuts with pipe threads.			A525-71	
Galvanized iron and steel sheets.	11	Z124.1		
Gel-coated glass-fiber reinforced polyester resin bath units.	11	Z124.2		
Gel-coated glass-fiber reinforced polyester resin shower units.	15			
Plumbing fixtures—land use.				F.S. WW-P-541b and interim amendments 4 and 6
Precast jointing material for clay pipe.				See section H 62.19 (1) (a) and (c), Wis. Adm. Code
Rubber gasket for cast iron soil pipe and fittings.	12		C564-68	
Sheet brass.			B36-67	
Sheet copper.			B152-66	
Sheet lead.			B243-71	Min. weight—4 lb. per sq. ft.
Soft solder.			B32-68T	
Valves.			A181-65	See section H 62.19 (1) (a) and (c), Wis. Adm. Code
Water hammer arrestors.		C72.1-1949		ASSE 1003
Water heaters.		Z21.10.1-1966		ASSE 1010
Manhole frames and covers.		Z21.10.2a-1963		See section H 62.19 (1) (a) and (c), Wis. Adm. Code

3. The wall thickness of fittings and hubs shall correspond with that of the pipe of the same size and kind. Change of direction, 45° elbows, 45° Y and 1/8 bend or fittings producing a like radius may be used in lieu of the elbows listed.

4. Cast iron soil pipe fittings. Change in direction. When direction of flow changes from horizontal to vertical, the radius of bends shall be as follows: (All dimensions are given as inches.)

Size of pipe -----	2	3	4	5	6
Minimum radius -----	3	3½	4	4½	5

When direction of flow changes from vertical to horizontal or when it is at right angles and changes in the same horizontal plane, the radii of bends shall be as follows: (All dimensions are given as inches.)

Size of pipe -----	2	3	4	5	6
Minimum radius -----	8	8½	9	9½	10

5. Building sewer and drain application prohibited. See Wis. Adm. Code section H 62.24.

6. Cast iron threaded drainage fittings. The face to center measurements for screw thread drainage fittings shall be as follows:

PIPE SIZE

1¼"	1½"	2"	2½"	3"	4"
-----	-----	----	-----	----	----

When change of direction is from horizontal to vertical:

2¼"	2½"	3⅛"	3⅞"	4¼"	5⅝"
-----	-----	-----	-----	-----	-----

When change of direction is from vertical to horizontal or horizontal to horizontal:

3"	3½"	4"	4½"	5¼"	6¼"
----	-----	----	-----	-----	-----

Change of direction, 45° elbows, 45° Y and 1/8 bend or fittings producing a like radius may be used in lieu of the elbows listed.

7. Copper water tube used for underground water lines may be soft or hard temper. Copper water tube used for interior aboveground water lines shall be hard temper, except concealed vertical tube may be soft temper for repair or replacement lines. Copper tube used for soil, waste and vent piping shall be hard temper. See Wis. Adm. Code sections H 62.05 (2), H 62.06 (4), H 62.07 (18), H 62.13 (2) (b) and H 62.13 (4) (b).

8. Copper, brass and bronze drainage fittings. Change of direction, 45° elbows, 45° Y and 1/8 bend or fittings producing a like radius may be used in lieu of the elbows listed.

The radii of wrought copper or cast brass or bronze waste fittings shall be as follows:

PIPE SIZE

1¼"	1½"	2"	2½"	3"	4"
-----	-----	----	-----	----	----

When change of direction is from horizontal to vertical:

1½"	1¾"	2⅞"	3⅝"	4½"
-----	-----	-----	-----	-----

When change of direction is from vertical to horizontal or horizontal to horizontal:

2¾"	2¾"	3¾"	4⅝"	5⅝"
-----	-----	-----	-----	-----

9. Plastic pipe and fittings—DWV. a. Plastic pipe and fittings shall not be embedded in masonry or concrete and shall be installed exposed or in frame partitions or in accessible tunnels, shafts or crawl spaces. For installations in excess of 3 stories or 35 feet, detailed plans and specifications shall be submitted to the department for approval prior to installation.

b. Schedule 40 plastic pipe and fittings shall not be threaded. When threaded construction is necessary, adapter fittings shall be used to make the transition. Only ABS-DWV socket type fittings shall be used with ABS pipe, and PVC-DWV socket type fittings with PVC pipe. The intermixing of the two type of plastic pipe and fittings is prohibited. The solvent cement for jointing shall meet the requirements of ASTM D-2235-67 for ABS plastic pipe and fittings, and ASTM D-2564-67 for PVC plastic pipe and fittings.

c. An approved plastic expansion joint shall be installed immediately above the cleanout in all vertical soil and waste stacks extending one or more floors in height. When the horizontal offset precedes the vertical rise, an expansion joint shall not be required. See following sketch.

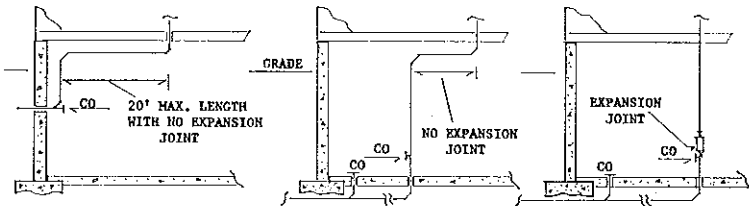

All stacks or piping extending through the roof of the structure shall terminate with an approved expandable type roof terminal flashing or an approved no-caulk neoprene ring roof flashing.

d. All pipe and fitting materials are to be identified as set forth in ASTM Standards D 2661-68 and D 2265-68.

10. Plastic water service piping. a. Plastic water service piping may be installed for cold water only. The use of plastic water service piping from the water main in the street to the curb stop is subject to water department ordinances or local governmental acceptance. Plastic water service piping entering the building shall terminate within 5 feet inside the point of entering the building.

b. The plastic pipe, fittings and solvent cements shall be approved by the National Sanitation Foundation for potable water supply and bear the NSF seal of approval. They also shall comply with the applicable ASTM standards.

c. The plastic pipe and fittings shall have a pressure rating of no less than 160 pounds per square inch; pipe 2 inches and larger shall have a safety factor ratio of 4 to 1 and shall require approval by the department prior to installation. The pressure rating shall be marked on the pipe.

d. Electric grounding to water distribution systems which have utilized plastic water service piping is prohibited.

e. Plastic materials shall be installed according to manufacturer's recommendation or applicable ASTM Standards.

11. Gel-coated fiberglass bath and shower units. All units shall be approved by the department. All nonexposed areas, those not gel-coated, shall have an outer coating of self-extinguishing resin at least $\frac{1}{8}$ of an inch in thickness or shall be constructed entirely of self-extinguishing resin. The resin shall be rated self-extinguishing according to ASTM D 635-68. Domes or ceilings shall meet the same specifications. If wood or other materials are used for structure stability or sound deadening, the material used shall be completely enclosed with self-extinguishing resin. When urethane foam is used, it shall meet ASTM D 1692-68 rating as self-extinguishing.

12. See Wis. Adm. Code section H 62.18 (2) (e) 2.

13. Corrugated steel pipe may be used for storm building sewers subject to the following conditions:

a. The pipe is sized according to tables 11, 11a, 11b and 12, Wis. Adm. Code section H 62.12, with adjustments considered to allow for flow characteristics and configuration of the pipe.

b. The connection from a building storm drain to a corrugated steel building storm sewer shall be made at least 10 feet outside the building wall or foundation.

14. Asbestos cement storm drainage pipe conforming to ASTM C663-70 may be installed for storm sewers from a point at least 10 feet outside the building wall or foundation.

15. Brass tubing. All brass tubing used for fixtures, traps and overflows between wall or floor and fixtures shall be made of seamless brass tube with a thickness of at least 0.0453 inch (No. 17 Brown and Sharpe gauge) and shall conform to A.S.T.M. "Standard Specifications for Seamless Brass Tubes," serial number B-135-67.

(b) *Miscellaneous materials.* 1. Backwater valves. Backwater valves shall have cast iron or brass bodies, noncorrosive bearings, seats and self-aligning disks, and shall be so constructed as to insure a positive mechanical seal and to remain closed, except when discharging wastes. Such valves shall remain sufficiently open during periods of low flows to avoid screening of solids and shall not restrict capacities or cause excessive turbulence during peak loads. Valve access covers shall be bolted type with gasket and each valve shall bear the manufacturers name cast into the body.

2. Caulking ferrules. a. Caulking ferrules for lead pipe or copper tube to cast iron shall be of red brass, free from sand holes, flaws or other defects, uniform in thickness, and at least $4\frac{1}{2}$ inches long, of a size and weight as shown in table 33.

Table 33

Inside diameter, inches	Weight
1½	1 lb. 1 oz.
2	1 lb. 4 oz.
3	1 lb. 14 oz.
4	2 lb. 8 oz.
5	3 lb. 0 oz.
6	3 lb. 8 oz.

b. Caulking ferrules for connection between national taper pipe thread and cast iron pipe shall be brass or cast iron. Brass ferrules shall conform to section H 62.19 (2) (b) 2. a. as to materials. Cast

iron ferrules shall conform to Wis. Adm. Code section H 62.10 (5), table 7.

3. Cleanout ferrules and plugs. See Wis. Adm. Code section H 62.10 (5) (a) and (7).

4. Closet bolts, nuts and screws for floor outlet fixtures connecting to a floor flange shall be brass or copper. Bolts and nuts for wall outlet fixtures shall be brass or corrosive resistant plated steel.

5. Dishwasher air-gaps as approved by the department.

6. Floor flanges for water closets and similar fixtures shall be brass not less than $\frac{1}{8}$ inch thick, cast iron not less than $\frac{1}{4}$ inch thick or galvanized malleable iron, hard lead or other material approved by the department. Caulked-on flanges shall have a caulking depth of at least 2 inches.

7. Footing, foundation and groundwater collecting piping within a building shall be asbestos cement, bituminous fiber, cast iron, concrete, vitrified tile or other material approved by the department.

8. Lead soil, waste and vent piping shall be the best quality drawn lead pipe, having a minimum weight per foot as follows:

Inside diameter, inches	1 $\frac{1}{4}$	1 $\frac{1}{2}$	2	3	4
Weight per foot, pounds	2 $\frac{1}{2}$	3 $\frac{1}{2}$	4 $\frac{3}{4}$	6	8

Lead traps and lead bends shall have a minimum wall thickness of $\frac{1}{8}$ inch. Lead water piping shall have minimum weights as indicated in table 34.

Table 34

Inside diameter, inches	Weight lbs. per foot	Wall thickness inches
$\frac{3}{8}$	2	
$\frac{1}{2}$	2	
$\frac{5}{8}$	3	
$\frac{3}{4}$	3 $\frac{1}{4}$.231
1	4 $\frac{3}{4}$.246
1 $\frac{1}{4}$	7 $\frac{3}{4}$.820
1 $\frac{1}{2}$	11 $\frac{1}{4}$.386
2	19 $\frac{1}{2}$.504

Sheet lead for safin pans shall weigh not less than 4 pounds per square foot. Sheet lead for flashings and roof terminals shall weigh not less than 3 pounds per square foot.

9. Solder bushings shall be red brass with minimum weights as follows:

Pipe size inches	Minimum weight each
1 $\frac{1}{4}$	6 oz.
1 $\frac{1}{2}$	8 oz.
2	14 oz.
2 $\frac{1}{2}$	1 lb. 6 oz.
3	2 lb. 0 oz.
4	3 lb. 8 oz.

10. Sheet copper for the following uses: a. General use including safe pans—minimum 12 ounces per square foot.

b. Flashings for vent terminals—minimum 8 ounces per square foot.

11. Galvanized sheet iron or steel for vent terminal flashings shall not be lighter than number 28 Brown and Sharpe gauge.

Note: Copies of standards promulgated by the following technical societies, referred to above are on file in the offices of secretary of state, health and social services and revisor of statutes and may be obtained for personal use from the following addresses:

American National Standards Institute, Inc.
1430 Broadway, New York, New York 10018
American Society for Testing and Material
1916 Race St., Philadelphia, Pa. 19103
American Water Works Association
2 Park Avenue, New York, New York 10016
Cast Iron Soil Pipe Institute
2029 K Street, NW
Washington, D. C. 20006
National Sanitation Foundation
Testing Laboratory, Inc.
P. O. Box 1468
Ann Arbor, Michigan 48106
American Society of Sanitary Engineering
960 Illuminating Building
Cleveland, Ohio 44113

History: 1-2-56; r. and recr. Register, November, 1972, No. 203, eff. 12-1-72.

H 62.20 Private domestic sewage treatment and disposal systems.

(1) **APPROVALS AND LIMITATIONS.** (a) *Allowable use.* Septic tank and effluent absorption systems or other treatment tank and effluent disposal systems as may be approved by the department may be constructed when no public sewerage system is available to the property to be served or likely to become available within a reasonable time. All domestic wastes shall enter the septic or treatment tank unless otherwise specifically exempted by the department or this section.

(b) *Public sewer connection.* Private domestic sewage treatment and disposal systems shall be discontinued when public sewers become available to the building served. The building sewer shall be disconnected from the private system and be connected to the public sewer. All abandoned septic tanks and seepage pits shall have the contents removed and shall be immediately filled with sand, gravel or similar material.

(c) *Plans and specifications.* 1. Public buildings. Complete plans and specifications shall be submitted to the department and written approval received before letting contracts or commencing work for all private domestic sewage treatment and disposal systems, and for the addition to or replacement of existing systems for all public buildings. Included as public buildings but not limited by enumeration herewith are:

- a. Theaters and assembly halls
- b. Schools and other places of instruction
- c. Apartment buildings, hotels and places of detention
- d. Factories, office and mercantile buildings
- e. Mobile home parks, camp grounds and camping resorts
- f. Parks

2. Local approval. The approval by county or other local governmental agency shall not exempt the requirements for state approval for the installation of sewage treatment and disposal systems serving public buildings.

3. Submission of plans and specifications. All plans and specifications shall be submitted in triplicate and shall include the following:

a. Detailed plan of the proposed septic tank or treatment tank and effluent disposal system showing building location with all lateral distances indicated, including distance from building served to system, from system to well, lot line, lake, stream or other watercourse.

b. Legal description of the property on which the system is to be installed.

c. Soil boring and percolation test data.

d. Ground slope and lot size.

e. Complete data relative to the expected use and occupancy of the building to be served.

4. Availability of plans. There shall be maintained at the project site one set of plans bearing the department's stamp of approval.

(d) *Specific limitations.* 1. Cesspools. Cesspools are prohibited.

2. Revised plans. Approved plans and specifications shall not be revised except with the written approval of the department.

3. Industrial wastes. When industrial wastes are intended to be disposed of by soil absorption, the department shall be consulted as to requirements.

4. Clear water. The discharge of surface, rain and other clear water into a private domestic sewage disposal system is prohibited.

(2) SOIL TESTS AND SITE REQUIREMENTS. (a) *Soil tests supervision.* Soil boring and percolation tests shall be made by or under the direction and control of a master plumber, or master plumber restricted licensed in Wisconsin to install private sewage disposal systems or an engineer, architect, surveyor or sanitarian registered in Wisconsin. Certification of the tests shall be signed by the person providing supervision and control on blank forms furnished by the department.

(b) *Percolation and boring tests.* 1. The size and design of each proposed soil absorption system shall be determined from the results of soil percolation tests and soil borings conducted in accordance with this section. At least 3 percolation tests shall be conducted with the holes located uniformly over the area and to the depth of the proposed absorption system. At least 3 soil borings shall be dug to a depth at least 3 feet below the bottom of the proposed system. The borings shall be distributed uniformly in the area of the proposed system.

2. When a property consists entirely of soils having very severe limitation for on-site liquid waste disposal as determined by use of a detailed soil map drawn at a scale of not more than 2,000 feet to the inch and interpretive data, prepared by the U.S.D.A. Soil Conservation Service or the University of Wisconsin, showing soil series, types and phases, that map and interpretive data may be used as a basis for denial of a state or local permit or approval of an on-site waste disposal system. Permits or approval can also be denied for properties comprised entirely of soils having severe limitations for on-site liquid waste disposal until appropriate action is taken to overcome that limitation. Nevertheless, in all cases the property owner shall be permitted to present evidence using soil percolation test data, bore hole data and topographic survey data to support the contention that a suitable site for an on-site liquid waste disposal system does exist.

(c) *Septic tank location.* No tank shall be located within 5 feet of any building or its appendage, 2 feet of any lot line, 10 feet of any cistern, 25 feet from any well, reservoir, swimming pool or the high

water mark of any lake, stream, pond or flowage. Where practicable, greater distances should be maintained.

(d) *Soil absorption site.* 1. Location. All soil absorption disposal systems should be located at a point lower than the surface grade of any nearby water well. The soil absorption system shall be located not less than 25 feet from any building, dwelling or cistern, 50 feet from any water well, reservoir or swimming pool, 5 feet of any lot line, 25 feet of any water service or 50 feet of the high water mark of any lake, stream or other watercourse. Where possible, greater distances should be maintained.

2. Percolation rate—trench or bed. A subsurface soil absorption system of the trench or bed type shall not be installed where the average percolation rate of the 3 tests for the site is slower than 60 minutes for water to fall one inch.

3. Percolation rate—seepage pit. For a seepage pit, percolation tests shall be made in each vertical stratum penetrated below the inlet pipe. Soil strata in which the percolation rates are slower than 30 minutes per inch shall not be included in computing the absorption area. The average of the results shall be used to determine the absorption area.

4. Flood plain. A soil absorption system shall not be installed in a flood plain.

5. Slope. The soil absorption system shall be constructed on that portion of the lot which does not exceed the slope here specified for the class. In addition, the soil absorption system shall be located at least 20 feet from the top of the slope.

Minutes Required for Water to
Fall One Inch

Class	Shallow Absorption Systems	Deep Absorption Systems	Slope
1.....	Under 3	Under 2	20%
2.....	3 to 45	2 to 30	15%
3.....	45 to 60	30 to 60	10%

6. Filled area. A soil absorption system shall not be installed in a filled area unless written approval is received from the department.

7. Ground water and bedrock. There shall be at least 3 feet of soil between the bottom of the soil absorption system and high ground water or bedrock.

(3) PERCOLATION TEST PROCEDURE. (a) *Type of hole.* The hole shall be dug or bored. It shall have vertical sides and have a horizontal dimension of 4 to 12 inches.

(b) *Preparation of hole.* The bottom and sides of the hole shall be carefully scratched with a sharp pointed instrument to expose the natural soil interface. All loose material shall be removed from the bottom of the hole which shall then be covered with 2 inches of coarse sand or gravel when necessary to prevent scouring.

(c) *Test procedure, sandy soils.* For tests in sandy soils containing little or no clay, the hole shall be carefully filled with clear water to a minimum depth of 12 inches over the gravel and the time for this amount of water to seep away shall be determined. The procedure shall be repeated and if the water from the second filling of the hole

at least 12 inches above the gravel seeps away in 10 minutes or less, the test may proceed immediately as follows: Water shall be added to a point not more than 6 inches above the gravel. Thereupon, from a fixed reference point, water levels shall be measured at 10-minute intervals for a period of one hour. If 6 inches of water seeps away in less than 10 minutes, a shorter interval between measurements shall be used, but in no case shall the water depth exceed 6 inches. The final water level drop shall be used to calculate the percolation rate. Soils not meeting the above requirements shall be tested as in subsection (d) below.

(d) *Test procedure, other soils.* The hole shall be carefully filled with clear water and a minimum water depth of 12 inches shall be maintained above the gravel for a 4-hour period by refilling whenever necessary or by use of an automatic siphon. Water remaining in the hole after 4 hours shall not be removed. The soil shall be allowed to swell not less than 16 hours or more than 30 hours. Immediately following the soil swelling period, the percolation rate measurements shall be made as follows: Any soil which has sloughed into the hole shall be removed and water shall be adjusted to 6 inches over the gravel. Thereupon, from a fixed reference point, the water level shall be measured at 30-minute intervals for a period of 4 hours unless 2 successive water level drops do not vary by more than $\frac{1}{8}$ of an inch. The hole shall be filled with clear water to a point not more than 6 inches above the gravel whenever it becomes nearly empty. Adjustment of the water level shall not be made during the last 3 measurement periods except to the limits of the last measured water level drop. When the first 6 inches of water seeps away in less than 30 minutes, the time interval between measurements shall be 10 minutes and the test run for one hour. The water depth shall not exceed 6 inches at any time during the measurement period. The drop that occurs during the final measurement period shall be used in calculating the percolation rate.

(e) *Verification.* 1. Physical characteristics. Depth to high ground water and bedrock, ground slope and percolation test results shall be subject to verification by the department. Verification of high ground water shall include, but not be limited to, a morphological study of soil conditions with particular reference to soil color and sequence of horizons.

2. Filling. Where the natural soil condition has been altered by filling or other attempts to improve wet areas, verification may require observation of high ground water levels under saturated soil conditions.

Note: Detailed soil maps are of value for determining estimated percolation rates and other soil characteristics.

(4) **TREATMENT TANKS.** (a) *Design.* 1. General requirements. a. Septic tanks shall be fabricated or constructed of welded steel, monolithic concrete or other materials approved by the department. All tanks shall be watertight and fabricated so as to constitute an individual structure.

b. The design of prefabricated septic tanks shall be approved by the department.

c. Plans for site-constructed concrete tanks shall be approved by the department prior to construction.

d. The liquid depth shall not be less than 3 feet nor more than an average of 6 feet. The total depth shall be at least 8 inches greater than the liquid depth.

e. Rectangular tanks shall have a minimum width of 36 inches and shall be constructed with the longest dimensions parallel to the direction of flow.

f. Cylindrical tanks shall have an inside diameter of not less than 48 inches.

g. Each prefabricated tank shall be clearly marked to show liquid capacity and the name and address or registered trademark of the manufacturer. The markings shall be inscribed into or embossed on the outside wall of the tank immediately above the outlet opening. Each site-constructed concrete tank shall be clearly marked at the outlet opening to show the liquid capacity. The marking shall be inscribed into or embossed on the outside wall of the tank immediately above the outlet opening.

h. Precast concrete tanks shall have a minimum wall thickness of 2 inches.

2. Materials and joints. a. The concrete used in constructing a precast or site-constructed tank shall be a mix to withstand a compressive load of at least 3,000 pounds per square inch. All concrete tanks shall be designed to withstand the pressures to which they are subjected.

b. The floor and sidewalls of site-constructed concrete tanks shall be monolithic except a construction joint will be permitted in the lower 12 inches of the sidewall of the tank. The construction joint shall have a key way in the lower section of the joint. The width of the key way shall be approximately 30% of the thickness of the sidewall with a depth equal to the width. A continuous water stop or baffle at least 6 inches in width shall be set vertically in the joint, embedded one-half its width in the concrete below the joint with the remaining width in the concrete above the joint. The water stop or baffle shall be copper, neoprene, rubber or polyvinylchloride designed for this specific purpose.

c. Joints between the septic tank and its cover and between the septic tank cover and manhole riser shall be tongue and groove or shiplap type and sealed watertight using neat cement, cement or bituminous compound.

d. Steel tanks shall be fabricated of new, hot rolled commercial steel. The tanks, including cover with rim, inlet and outlet collars and manhole extension collars shall be fabricated with welded joints in such manner as to provide structural stability and watertightness. Steel tanks shall be coated, inside and outside, in compliance with the U. S. Department of Commerce Commercial Standard 177.

Note: Commercial standard CS 177-62 of the U. S. Department of Commerce is available for inspection at the office of the department of Health and Social Services, the Secretary of State and the Revisor of Statutes, or may be procured for personal use from the Superintendent of Documents, U. S. Government Printing Office, Washington 25, D. C.

Any damage to the bituminous coating shall be repaired by recoating prior to installation of the tank. The gauge of the steel shall be as follows:

Septic Tank Capacity	Tank Component	Gauge of Steel
500 to 1,000 gallons-----	Bottom and sidewalls-----	14
	Cover-----	12
	Baffles-----	12
1,000 to 2,000 gallons-----	Complete tank-----	10
2,000 or more gallons-----	Complete tank-----	7

3. Tank accessories. a. The inlet and outlet openings shall contain a "boss," stop or other provision which will prevent the insertion of the sewer piping beyond the inside wall of the tank.

b. The inlet and outlet on all tanks or tank compartments shall be provided with open-end coated iron sanitary tees or baffles made of approved materials, so constructed as to distribute flow and retain scum in the tank or compartments. The tees or baffles shall extend at least 6 inches above and 9 inches below the liquid level, but not to exceed $\frac{1}{2}$ the liquid depth. At least 2 inches of clear space shall be provided over the top of the baffles or tees. The bottom of the outlet opening shall be at least 2 inches lower than the bottom of the inlet.

c. Each single compartment tank and each unit of a multicompartment tank shall be provided with at least one manhole opening no less than 24 inches square or 24 inches in diameter. Manholes shall terminate no more than 6 inches below the ground surface and be provided with a substantial, fitted, watertight concrete, steel or cast iron cover. Steel tanks shall have a collar for the manhole extensions permanently welded to the tank. The collar shall have a minimum height of 2 inches.

d. An airtight inspection opening shall be provided over the inlet baffle of all septic tanks which may be either a manhole or a cast iron pipe at least 4 inches in diameter. The upper end of the inspection pipe or manhole shall terminate not more than 6 inches below the ground surface.

(b) *Capacity and sizing.* 1. Minimum capacity. The capacity of a septic tank shall be based on the number of persons using the building to be served or upon the volume and type of waste. The minimum liquid capacity shall be 500 gallons.

2. Multiple tanks. When increased capacity is to be provided by a multiple number of tanks, the capacity of any tank shall be a minimum of 500 gallons. When 2 or more tanks are installed, approval of the design of the system shall be obtained from the department. The installation of more than 4 tanks in series is prohibited. Installation of septic tanks in parallel is prohibited.

3. Sizing of tank. a. The minimum liquid capacity for one and two family residences shall be as established in the following table:

Number of Bedrooms	Septic Tank Capacity One and Two Family Residences	
	Normal Plumbing Fixtures	With Food Waste Grinder, Automatic Washer, Dishwasher Singly or in Combination
2 or less-----	500	750
3-----	650	975
4-----	800	1200
5-----	950	1375
6-----	1100	1650
7-----	1250	1875
8-----	1400	2200

b. For buildings other than one and 2 family residences the liquid capacity shall be increased above the 500-gallon minimum as established in the following table. For buildings having kitchen and/or laundry waste, the tank capacity shall be increased to receive the anticipated volume for a 24-hour period from the kitchen and/or laundry.

Apartment buildings (per bedroom).....	150	gals.
Assembly hall (per person—no kitchen).....	2	"
Bars and cocktail lounges (per patron space).....	9	"
Bowling alley (per alley).....	125	"
Bowling alley with bar (per alley).....	225	"
Camp grounds and camping resort (per camp space).....	100	"
Camps, day use only—no meals served (per person).....	15	"
Camps, day and night (per person).....	40	"
Car wash—subject to state approval		
Churches—no kitchen (per person).....	3	"
Churches—with kitchen (per person).....	7.5	"
Country clubs—subject to state approval		
Dance halls (10 sq. ft. per person).....	3	"
Dining hall—kitchen and toilet waste (per meal served).....	10	"
Dining hall—kitchen waste only (per meal served).....	3	"
Drive-in restaurants (per car space).....	30	"
Drive-in theaters (per car space).....	5	"
Factories and offices, (per employee—total all shifts—exclusive of industrial wastes).....	20	"
Hospitals (per bed space).....	200	"
Hotels or motels and tourist rooming houses (per room 2 persons per room).....	100	"
Migrant labor camp, central bath house (per employee).....	30	"
Mobile home parks, homes with bathroom groups (per site).....	200	"
Nursing and rest homes (per bed space).....	100	"
Parks, toilet wastes (per person—75 persons per acre).....	5	"
Parks, with showers and toilet wastes (per person—75 persons per acre).....	10	"
Restaurant—kitchen and toilet wastes (per seating space).....	30	"
Retail store (per employee).....	20	"
Retail store—customers (10 sq. ft. per person).....	1.5	"
Schools (per classroom).....	450	"
Schools with meals served (per classroom).....	600	"
Schools with meals served and showers provided (per classroom).....	750	"
Self-service laundries (per machine, toilet wastes only).....	50	"
Service stations (per car).....	10	"
Swimming pool bath houses (per person).....	10	"

(c) *Installation.* 1. Location. Tanks shall not be installed within the interior foundation walls of a building nor shall a new building or addition to an existing building be constructed or located over, or within 5 feet of a tank.

2. Bedding. A 3-inch thick tamped bedding shall be provided for all septic tank installations. The bedding material shall be sand, gravel, granite, limerock or other noncorrosive materials of such size that 100% will pass a ¼-inch screen.

3. Backfill. a. The backfill material for steel tanks shall be as specified for bedding and shall be tamped into place, care being taken to prevent damage to the coating.

b. The backfill for concrete tanks shall be soil material, 100% of which shall pass a 2-inch screen and shall be tamped into place.

4. Piping. The inlet and outlet piping between a septic or other sewage tank and the firm ground beyond the excavation made to install the tank shall be cast iron pipe or other pipe approved by the department for the specific purpose. The joints between pipe and tank openings shall be made with lead and oakum.

5. Manhole riser joints. a. All joints on steel risers shall be welded or flanged and bolted and be watertight. All manhole extensions shall be bituminous coated inside and outside.

b. All joints on concrete risers and manhole covers shall be tongue and groove or shiplap type and sealed watertight using neat cement, cement or bituminous compound.

(5) SOIL ABSORPTION SYSTEM. (a) *Disposal of tank effluent.* The effluent from septic tanks shall be disposed of by soil absorption systems or by such other manner approved by the department.

(b) *Sizing—residential.* The area required for a soil absorption system serving residential property shall be determined from the following table using soil percolation test data:

Percolation Rate Minutes Required for Water to Fall One Inch	Minimum Absorption Area in Square Feet Per Bedroom			
	Normal Plumbing Fixtures	With Garbage Grinder	With Automatic Washer	With Both Grinder and Automatic Washer
Less than 3	50	65	75	85
3 to 10	100	120	135	155
10 to 30	150	180	205	250
30 to 45	180	215	245	300
45 to 60	200	240	275	330

(c) *Sizing—Other.* The required area for a soil absorption system serving installations other than residential property shall equal the absorption area specified for normal plumbing fixtures according to the percolation test results multiplied by the applicable unit specified in column 2, multiplied by the applicable factor in column 3 of the following table:

Column 1 Building Classification	Column 2 Units	Column 3 Factor
Apartment buildings	1 per bedroom	1.0
Assembly hall—no kitchen	1 per person	0.02
Bar and cocktail lounge	1 per patron space	0.2
Bowling alley	1 per bowling lane	2.5
Bowling alley with bar	1 per bowling lane	4.5
Camps, day use only	1 per person	0.2
Camps, day and night	1 per person	0.45
Camp ground and camping resort	1 per camping space	0.9
Church—no kitchen	1 per person	0.04
Church—with kitchen	1 per person	0.09
Dance hall	1 per person	0.06
Dining hall—kitchen and toilet	1 per meal served	0.2
Dining hall—kitchen only	1 per meal served	0.1
Drive-in restaurant	1 per car space	0.6
Drive-in theater	1 per car space	0.1
Factories, office buildings, exclusive of industrial waste	1 per person	0.4
Hotels or motels and tourist rooming houses	1 per room	0.9
Hospital	1 per bed space	2.0
Migrant labor camp—central bath house	1 per employee	0.25
Mobile home park	1 per mobile home site	2.0
Nursing and rest homes	1 per bed space	1.0
Parks—toilet waste only	1 per acre	4.0
Parks—showers and toilets	1 per acre	8.0
Restaurant—kitchen and toilet	1 per seating space	0.6
Retail store	1 per employee	0.4
Retail store	1 per customer	0.08
Self-service laundry—toilet wastes only	1 per machine	1.0
Service station	1 per car served	0.15
Swimming pool bath house	1 per person	0.2
School—no meals, no showers	1 per classroom	5.0
School—meals served or showers	1 per classroom	6.7
School—meals and showers	1 per classroom	8.0

(d) *Installation.* 1. Shallow system. a. A seepage trench or a seepage bed having a depth of 36 inches or less below final grade shall be termed a shallow absorption system.

b. The bottom of the seepage trench shall be level. Seepage trench excavations shall be from 1 to 3 feet in width. The absorption area of a seepage trench shall be computed by using the bottom area only. Trench excavations shall be spaced at least 10 feet apart. The individual laterals preferably should not be over 100 feet long.

c. Seepage beds shall meet the requirements of a seepage trench except that the excavation is more than 3 feet wide and has more than one distribution line. Distribution lines in a seepage bed shall be uniformly spaced no more than 6 feet apart and no less than 3 feet apart and no more than 3 feet from the sidewall.

d. Seepage trenches or beds shall not be excavated when the soil is excessively wet.

e. All smeared or compacted surfaces in the seepage trench or bed shall be scarified to the depth of the compaction and the loose material removed.

f. Distribution piping shall be perforated clay tile, bituminous fiber or cement asbestos or short lengths of clay or concrete drain pipe. In seepage trenches or beds the bottom of the distribution piping shall be laid 12 to 24 inches below the surface in continuous straight or curved lines. A slope of 2 to 4 inches per 100 feet shall be maintained. Drain pipe shall be spaced approximately $\frac{1}{4}$ inch apart and blinded at the top with tar paper.

g. Fresh air inlets of cast iron pipe shall be provided and be placed so as to assure a free flow of air throughout the entire installation. The vent pipes shall be at least 4 inches in diameter and extend at least 12 inches above the ground surface and terminate with an approved vent cap. Fresh air inlets shall be located at least 25 feet from any window, door or air intake of any building used for human habitation. A maximum of 4 distribution lines may be served by one common 4-inch vent when interconnected by a common header pipe.

h. A minimum of 12 inches of clean, graded rock or similar aggregate ranging in size from 1 to $2\frac{1}{2}$ inches shall be laid into the trench or bed below the distribution pipe and such aggregate shall extend at least 2 inches over the top of the distribution pipe. The aggregate shall be covered with untreated building paper or 2 inches of marsh hay or equal. The first 4 to 6 inches of soil backfill shall be hand tamped.

i. Where the total lineal feet of drain pipe in a seepage trench or bed exceeds 1,000 feet, discharge of septic tank effluent into the absorption system should preferably be regulated by an automatic siphon. The dosing tank in which the siphon is situated shall have a capacity equal to 75% of the combined volume of the distribution lines in the absorption system.

2. Deep system. a. A seepage trench, seepage bed or a seepage pit developed to a depth of more than 36 inches below the final grade shall be termed a deep absorption system.

b. The bottom of the distribution line shall be laid 12 to 48 inches below the surface in continuous straight or curved lines. Slope, spacing and venting shall be equal to section H 62.20 (5) (d) 1.

c. Credit may be given for the added absorption area provided for the depth that exceeds 12 inches of aggregate below the distribution line. Such credit shall be in accord with the following table which

establishes the percentage of length of a standard absorption trench. The standard absorption trench is one which the aggregate material extends 12 inches below the distribution pipe.

Depth of Aggregate Below Distribution Line	Percent of Length of Standard Trench			
	Trench Width 12"	Trench Width 18"	Trench Width 24"	Trench Width 36"
12	100	100	100	100
18	75	78	80	83
24	60	64	66	71
30	50	54	57	62
36	43	47	50	55
42	37	41	44	50
48	33	37	40	46

d. The area of a seepage bed having aggregate to a depth that exceeds 12 inches below the distribution pipe may be computed as follows:

$$\text{Percent of standard bed area} = \frac{w + 2}{w + 1 + 2d} \times 100$$

w = width of bed in feet

d = depth of aggregate below distribution pipe in feet minus 6 inches

e. A seepage pit shall have a minimum inside diameter of 5 feet and shall consist of a chamber walled up with material such as a perforated precast concrete ring, concrete block, brick or other material approved by the department which allows effluent to percolate into the surrounding soil. Seepage pits shall be located 10 feet or more apart. The pit bottom shall be left open to the soil. Crushed rock or similar aggregate 1 to 2½ inches in size shall be placed into a 6-inch minimum annular space separating the outside wall of the chamber and sidewall excavation. Depth of the annular space shall be measured from the inlet pipe to the bottom of the walled-up chamber. Each seepage pit shall be provided with a 24-inch manhole extending within 6 inches of the ground surface and a 4-inch fresh air inlet which shall meet the requirements of sections H 62.20 (4) (a) and H 62.20 (5) (d). Excavation and scarifying shall be in accord with section H 62.20 (5) (d). The effective area of a seepage pit shall be the vertical wall area of the walled-up chamber for the depth below the inlet for all strata for which the percolation rates are lower than 30 minutes per inch. Six inches of annular opening outside the vertical wall area may be included for determination of effective area. The following table may be used for determining the effective sidewall area of circular seepage pits:

Effective Absorption Area Seepage Pit*

Inside Diameter of Walled-Up Chamber in Feet*	Depth Below Inlet					
	3	4	5	6	7	8
7	75	101	126	151	176	201
8	85	113	142	170	198	226
9	94	126	157	188	220	251
10	104	138	173	208	242	277
12	123	163	204	245	286	327

*The 6 inch annular opening credit is included.

(6) MAINTENANCE AND SLUDGE DISPOSAL. (a) *Maintenance.* Septic tanks shall be cleaned whenever the sludge and scum occupies $\frac{1}{2}$ of the tank volume. All sludge, scum, liquid and any other material removed from a private domestic sewage treatment and disposal system is hereafter referred to as sludge.

(b) *Sludge disposal.* Sludge shall be disposed of as follows:

1. Public sewer. By discharge into a public sewerage system when practical. The point and method of discharge into the system shall be subject to the requirements of the municipality.

2. Approved site. By discharge at a disposal site designated by the local governmental authority.

3. Other. In the absence of a public sewerage system or designated disposal site by one of the following methods:

a. By burial under 36 inches of earth on the premises on which produced at a distance of at least 50 feet from a well or if on other premises at a distance of at least 500 feet from a place of habitation provided that there is also at least 36 inches of soil between the buried sludge and the high ground water level or bedrock.

b. By spreading on land, not used for pasturing livestock or for growing vegetables, at a distance of at least 1,000 feet from a place of habitation or any stream, lake, pond or flowage.

4. Prohibited sites. The sludge shall not be disposed of by discharge into a lake, stream, ditch or dry run or be buried within 50 feet of such watercourses or in a flood plain.

(7) HOLDING TANKS. (a) *Approval.* Holding tanks shall be considered on an individual basis. Three complete sets of plans shall be submitted to the department for each request to install a holding tank. The installation of the holding tank shall be made in accord with the following criteria.

(b) *Installation.* 1. Materials. The tank shall be constructed of material approved by the department.

2. Location. Tanks shall be located in accord with section H 62.20 (2) (c) except the tanks shall be 20 feet from a building or its appendage.

3. Capacity. Tanks shall have a minimum 5-day holding capacity. Sizing shall be based in accord with section H 62.20 (4) (b).

4. Warning device. A high water warning device shall be installed. This device shall be either an audible or an illuminated alarm. If the latter, it shall be conspicuously mounted.

5. Manhole. Each tank shall be provided with a round manhole at least 24-inch inside diameter extending at least 6 inches above ground surface. Each manhole cover shall have an effective locking device.

6. Septic tank. If an approved septic tank is installed to serve as a holding tank, the inlet and outlet baffles shall be removed and the outlet sealed.

7. Vent. Each tank shall be provided with a minimum 2-inch fresh air inlet extending 12 inches above final grade terminating with a return bend fitting.

8. Servicing. Holding tanks shall be serviced in accord with chapter 146, Wis. Stats., Wis. Adm. Code chapter RD 13, and section H 62.20 (6).

History: 1-2-56; am. (1) (f), Register, June, 1956, No. 6, eff. 7-1-56; am. (2) (a), (2) (b), (2) (c) 2, Register, February, 1957, No. 14, eff. 3-1-57; am. (1) (b), (d) and (e), Register, April, 1962, No. 76, eff. 10-1-62; r. and recr. Register, November, 1969, No. 167, eff. 12-1-69; am. (5) (d) 2, e., Register, October, 1971, No. 190, eff. 11-1-71; r. and recr. (2) (b), Register, November, 1972, No. 203, eff. 12-1-72.

Register, November, 1972, No. 203

H 62.21 Hangers and supports. (1) **GENERAL.** All piping in a plumbing system shall be installed without undue strains and stresses and provision shall be made for expansion, contraction and structural settlement and backgrounds where necessary.

(2) **PIPE SUPPORTS.** (a) *Stacks.* All pipes shall be supported so that alignment is retained and the weight of the pipes shall not bear upon a caulked joint, except where the spigot end of one vertical pipe rests in the hub end of the next lower vertical pipe. All vertical stacks extending 3 floors or more in height shall be supported on concrete or masonry piers. All vertical piping shall be provided with an approved support at each floor or approximately every 10 feet.

(b) *Pipe supports—water distribution.* All piping shall be supported to prevent undue strains upon connections or fixtures and shall be so aligned and graded that the entire system or parts thereof can be controlled and drained. The formation of traps and/or sags in water piping shall be avoided where possible. When unavoidable, such sags, traps or inverts shall have provisions for properly draining same.

(3) **HANGERS.** (a) All horizontal piping above the floor shall be supported or anchored by approved wall brackets, copper, iron or steel hangers, concrete or masonry piers set at intervals not to exceed 10 feet. Cast iron pipe shall be supported at the joint and intervals not to exceed 5 feet. Copper tubing shall be supported at approximately 6 feet for piping $1\frac{1}{4}$ inches inside diameter and less, and at intervals not to exceed 10 feet for piping $1\frac{1}{2}$ inches inside diameter and larger. Lead pipe shall be supported in its entirety. Bracket, hanger and support materials in contact with the pipe or tubing shall be compatible. Plastic DWV piping shall be supported at intervals of not more than 4 feet, at the end of branches and change of direction or elevation. Supports shall allow free movement. Vertical piping shall be maintained in a straight alignment. Support trap arms in excess of 3 feet in length as close as possible to the trap. Closet rings shall be securely fastened with corrosive resistant fasteners to the floor. Closet bends or stubs shall be stabilized against all horizontal or vertical movement. Pipe exposed to damage by sharp surfaces shall be protected with grommets or sleeves of rubber or plastic. Hangers and straps shall not compress, distort, cut or abrade the piping and shall allow free movement of pipe. All horizontal piping exceeding 20 feet in length shall have an approved ABS or PVC expansion joint installed. See following sketch.

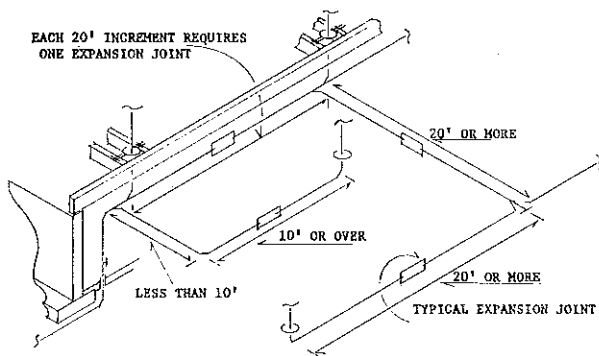

(b) Metal hangers used on pipe or tubing in excess of 4 inches inside diameter shall be of ring and rod, trapeze or other approved type. Perforated band iron or extension bar a minimum of $\frac{3}{4}$ inch wide and 20 gauge thickness may be used for pipe and tubing 2 inches inside diameter and less, and a minimum of $\frac{7}{8}$ inch wide and 18 gauge thickness for pipe and tubing $1\frac{1}{4}$ to 4 inches inside diameter inclusive. Bolts, screws and anchors shall be of sufficient strength to sustain their proportional share of the pipe weight and contents and maintain alignment. Approved wire hooks will be allowed for pipe and tubing one inch inside diameter and less.

(c) *Concrete inserts.* 1. In concrete construction, approved inserts set in the concrete may be installed for the support of hangers. The use of wood plugs is not permitted.

2. Hangers should be installed without regard to the support of the sleeves where pipes are run through concrete beams. Such sleeves should not normally be used for the support of pipes.

3. Expansion shields for supporting pipes under concrete construction should preferably be used in a horizontal position in the sides of beams, but in good, sound concrete having gravel or crushed stone aggregate, they may be used in the vertical position to support pipes 4 inches or less in diameter. In all cases, the suitability of the concrete shall be determined before using expansion shields. Where increaser couplings are used, they shall be attached immediately adjacent to the expansion shield.

4. For the support of pipes 4 inches and larger, expansion shields if used in the vertical position shall alternate with hangers connected directly to the structural members such as trusses and girders, or to the sides of concrete beams. In the absence of convenient structural members, pipes 4 inches and larger may be supported entirely by expansion shields in the vertical position, but spaced not over 10 feet apart.

5. Expansion shields shall not be used in ceilings of gypsum, cinder concrete or similar soft material.

6. Expansion shields used in the vertical position shall have holes made of the proper size and be drilled with care to provide for a uniform contact with the shield over its entire circumference. Depth of the hole shall in no case be less than specified for the type of shield used.

7. Holes for shields in the side of concrete beams shall ordinarily be above or as close to the center line as possible.

8. Where pipes are run through concrete beams, sleeves shall be at least one size larger than the piping used.

(4) **BACKGROUNDS.** Substantial backgrounds or approved manufactured supporting devices shall be provided for all fixtures.

History: 1-2-56; r. and rec. Register, November, 1972, No. 203, eff. 12-1-72.

H 62.22 History: 1-2-56; r. Register, October, 1971, No. 190, eff. 11-1-71.

H 62.22 Repairs and reconstruction. (1) **GENERAL.** Whenever it shall appear upon inspection that any part of an existing plumbing system is defective, or fails to conform to the requirements of this chapter and by reason of such failure tends to create a health hazard, it shall be repaired, renovated, replaced or removed.

(2) **FIXTURES REPLACED.** When an old or defective fixture is removed, to be replaced by a new one, and no other fixture or piping is to be added or remodeled, it will not be necessary to reconstruct the soil, waste or vent piping to make it conform to this chapter, unless the same is in a defective condition. In such cases, if found necessary, the fixtures shall be provided with efficient deep seal traps or deep seal resealing traps of the self-scouring centrifugal type.

(3) **RECONSTRUCTION.** When old or defective plumbing is to be remodeled, additional fixtures installed or the whole plumbing system moved to another part of the building, the remodeled system shall be made to conform to this chapter.

(4) **MATERIALS RE-USED.** All fixtures, soil, waste and vent pipes removed from a building, if found to be in good condition, may be used in the same building or may be used in another building, provided they are approved by the department or local plumbing inspector and the owner of the building in which they are to be installed gives his written consent.

(5) **EXISTING BUILDING SEWERS AND DRAINS.** Existing building sewers and drains may be used in connection with new buildings only when they are found on examination and test to conform to the requirements of this chapter governing building sewers and drains. If the existing work is found defective, the local or state inspector shall notify the owner of the changes necessary to make it conform to the requirements of this chapter.

(6) **REPAIRS.** All repairs to fixtures or piping shall be done in a substantial, sanitary and workmanlike manner.

History: Cr. Register, November, 1972, No. 203, eff. 12-1-72.

H 62.23 History: Cr. Register, February, 1957, No. 14, eff. 3-1-57; r. Register, October, 1970, No. 173, eff. 11-1-70 (see H 62.015).

H 62.23 Inspection and tests. (1) **APPROVED INSTALLATIONS.** Plumbing installations in newly annexed territory complying with the requirements of this chapter shall be approved by the local governing body of the municipality of which such territory becomes a part, and the owner of the property shall be granted permission to connect to the public water supply and sewerage system upon the payment of permit fees where such fees are required.

(2) **LOCAL INSPECTION.** (a) *Testing.* All piping of a drainage or plumbing system in cities and villages having local plumbing supervisors, except in case of repairs as specified in section H 62.23 (6), shall be tested by the plumber in charge, in the manner herein provided, in the presence of the local supervisor of plumbing or his authorized deputies. The material and labor for tests shall be furnished by the plumber in charge.

(b) *Notice for inspection.* The plumber in charge or the owner of the single family residential property (145.06 (4), Wis. Stats.), in case no plumber is employed, shall notify the supervisor in person, by telephone or in writing when the work is ready for inspection. If the inspection is not made by the end of the normal work day following notification, not including Saturday, Sunday or legal holidays, the plumber in charge or the owner may proceed with the work.

Register, November, 1972, No. 203

(c) *Preparations for inspection.* When work is ready for inspection, the plumber in charge, or in case none is employed, the owner, shall make such arrangements as will enable the supervisor to inspect all parts of the plumbing system. The plumber or owner shall have present the proper apparatus and appliances for making the tests, and shall furnish such assistance as may be necessary in making proper inspection.

(d) *Building drain tests.* The entire building drain with all its branches, receptacles and connections shall be brought so far as practicable to the surface or grade of basement floor and tested with water or air.

(e) *Storm water and clear water piping systems.* Rainwater conductors, roof connectors and clear water waste piping systems shall be tested with water or air.

(f) *Roughing in tests.* All work known as "roughing in" and "underfloor work" between the building drain connections to points above the finished floor and beyond the finished face of walls and partitions shall be tested.

(g) *Water and air test.* 1. *Water test.* The water test shall be applied to the drainage system in its entirety or in sections. If applied to the entire system, all openings shall be tightly closed, except the highest openings above the roof, and the system filled with water to the point of overflow above the roof. If the system is tested in sections, each opening shall be tightly plugged, except the highest opening of the section under test, and each section shall be filled with water. No section shall be tested with less than a 10 foot head of water or a 5 pound per square inch air pressure. In testing successive sections, at least the upper 10 feet of the next section shall be retested so that no joint or pipe in the building shall have been submitted to a test of less than a 10 foot head of water or 5 pounds per square inch air pressure. Under this test, the water pressure shall remain constant for not less than 15 minutes without further addition of water.

2. *Air test.* The air test applied to the drainage system shall be made by attaching the air compressor test apparatus to any suitable opening and closing all other inlets and outlets to the system, then forcing air into the system until there is a uniform pressure sufficient to balance a column of mercury 10 inches in height or 5 pounds pressure per square inch on the entire system. This pressure shall be maintained for a period of not less than 15 minutes without further addition of air.

(h) *Building sewer test.* The building sewer and/or the private interceptor main sewer beginning at the public sewer main or private domestic sewage disposal system (septic tank) to the building drain shall be inspected before covering and tested before or after backfilling. The tests may be performed with water or air.

1. *Water test.* The water test shall be applied to the building sewer and/or private interceptor main sewer in its entirety or in sections. The entire sewer or sections of the sewer shall be tightly closed and filled with water. Each section to be tested or the entire sewer shall not be tested with less than a 7 foot head of water or 3 pounds per square inch pressure. Under this test, the acceptable tolerances of infiltration or exfiltration shall not exceed 8½ gallons per hour, per inch of diameter, per mile.

2. Air test. The air test shall be applied to the building sewer and/or private interceptor main sewer in its entirety or in sections. The test shall be made by attaching the air compressor test apparatus to a suitable opening and closing all other openings, then forcing air into the sewer until there is a uniform pressure of 3 pounds per square inch on the entire sewer. Under this test, the acceptable tolerance shall be equivalent to the exfiltration or infiltration of not more than 8½ gallons per hour, per inch of diameter, per mile.

(3) COVERING OF WORK. No part of any plumbing or drainage system shall be covered until it has been inspected, tested and approved. If any part is covered before being tested and approved, it shall be uncovered at the direction of the supervisor. See section H 62.23 (2) (b).

(4) FINAL INSPECTION. When the plumbing or drainage system is completed and fixtures are installed, the final inspection shall be made. See section H 62.23 (2) (b).

(5) INSPECTION FOR CHANGES OR ALTERATIONS. When additional fixtures are installed or the style or location of any fixture is changed or when changes are made in the piping system, the work shall be inspected and tested if deemed necessary by the plumbing supervisor.

(6) TESTS FOR REPAIRS. Inspections may be made, but tests shall not be required after replacing an old fixture, faucet or valve by a new one to be used for the same purpose. Such repairs or alterations may not be construed to include cases where new vertical or horizontal lines of soil, waste, vent, or interior rainwater conductors are used or their relative locations changed. In a building condemned by the proper authorities because of insanitary conditions of house drainage or plumbing, such repairs or alterations as are necessary to make the plumbing sanitary shall be made to conform to the provisions of this chapter. Tests and inspections of such alterations shall be made as for new buildings. No test or inspection shall be required where a house drainage and plumbing system or part thereof is set up for temporary exhibition purposes.

(7) DEFECTS IN MATERIALS. If tests or inspection discloses defective material, leakage, or unworkmanlike construction, which does not conform to the requirements of this chapter, the same shall be removed and replaced and retested when necessary. The presence of any foreign substance about a joint or any part of a plumbing or drainage system shall be sufficient cause for condemning such joint or part of the system. Any split fittings, hubs or defective material which do not conform to the requirements of this chapter shall be removed and not used again. Poor workmanship, design or methods of installation likewise shall be sufficient cause for the condemnation of the whole or any part of the system.

History: Cr. Register, November, 1972, No. 203, eff. 12-1-72.

H 62.24 History: 1-2-56; renum. from H 62.23, Register, February, 1957, No. 14, eff. 3-1-57; r. Register, October, 1971, No. 190, eff. 11-1-71.

H 62.24 Alternate and experimental materials. (1) ACCEPTANCE OF ALTERNATE AND EXPERIMENTAL MATERIALS. (a) The provisions of this chapter are not intended to prevent the use of any alternate material or method of construction provided any such alternate has been first approved and its use authorized by the department.

Register, November, 1972, No. 203

(b) The department may approve any such alternate provided the findings of the proposed design are satisfactory and comply with the intent of this chapter and the material offered is for the purpose intended, at least the equivalent of that prescribed in this chapter or that the methods of installation proposed conform to other acceptable nationally recognized plumbing standards.

(c) The department shall require that sufficient evidence or proof be submitted to substantiate any claims that may be made regarding the sufficiency of any proposed material or type of construction.

(d) Test shall be made in accordance with approved standards, but in the absence of such standards, the department shall specify the test procedure.

(e) The department may require tests to be made or repeated if, at any time, there is reason to believe that any material or device no longer conforms to the requirements on which its approval was based.

(2) LISTING ALTERNATE AND EXPERIMENTAL MATERIALS. (a) Standards listed or referred to in table 35 cover materials which will conform to the requirements of this section when used in accord with the limitations imposed in this table or other sections of this chapter.

1. Reduced pressure zone principle type backflow preventers. a. Use limitations. Reduced pressure zone principle type backflow preventers may be used on cold water lines (maximum 110° F.) with a working pressure maximum of 150 pounds per square inch. The reduced pressure zone principle type backflow preventer may be installed with any plumbing fixture or equipment, the potable water supply outlet of which may be submerged and which cannot be protected by a vacuum breaker or a minimum air-gap. The use of a reduced pressure zone principle type backflow preventer does not eliminate requirements of this chapter for individual fixture devices such as vacuum breakers on flushometer valves, aspirators, sterilizers, etc., but not limited by enumeration.

b. Specifications. Reduced pressure zone principle type backflow preventers shall be manufactured to conform to the requirements of the American Water Works Association standard C506-69 and be approved by the department.

c. Installation. 1) Backflow preventers shall be installed above flood level. The location shall be accessible for testing, inspection and maintenance.

2) The reduced pressure zone principle type backflow preventer shall not be bypassed, made inoperative or removed without department approval. A complete history of each device shall be maintained by the owner to include a comprehensive listing from purchase to retirement, of all tests, inspections and repairs. The department reserves the right to require removal of the unit and replacement with an approved type installation if the unit does not provide full time protection against backflow or if inspections are not made regularly and reported to the department.

d. Approval. Approval shall be obtained from the department for each specific application prior to installation of the device. The request for approval shall be accompanied with detailed plans for the installation which must include the following information:

1) Location within building and elevation.

2) Piping diagrams detailing water supply inlet and detailed downstream piping diagrams indicating all fixtures, appliances, equipment, devices or appurtenances which the unit is serving. Anticipated flow rates are to be included on detailed plans along with manufacturer's name, model and size of reduced pressure zone principle type backflow preventer.

3) A copy of the annual inspection and maintenance agreement between owner and manufacturer's service representative or local plumbing inspector.

e. Testing. A reduced pressure zone principle type backflow preventer is a mechanical device that requires surveillance and periodic testing. An annual test shall be conducted in accordance with the following test procedure:

DIFFERENTIAL PRESSURE GAUGE TESTING METHOD FOR REDUCED PRESSURE BACKFLOW PREVENTER

Install test equipment as shown on following sketch.

Test No. 1

Purpose: To test operation of pressure differential relief valve.

Requirement: The pressure differential relief valve must operate to maintain the zone between the two check valves at least 2 psi less than the supply pressure.

Steps:

- a. Close No. 2 gate valve tight.
- b. Install bypass hose from test cock #2 through a control valve to test cock #3.
- c. Open test cocks #2 and #3 and vent gauge.
- d. Open control valve on bypass hose slowly and note differential on gauge at initial opening of differential relief valve. Enter pressure differential in psi report.
- e. Close bypass control valve.

Test No. 2

Purpose: To test No. 1 check valve for tightness against reverse flow.

Requirement: Valve must be tight against reverse flow under all pressure differentials.

Steps:

- a. If the pressure differential relief valve is operating properly, and there is no drainage from it with the No. 2 gate valve closed tight, the No. 1 check valve shall be noted in the report as "closed tight". If there is drainage from the pressure relief valve, the check shall be noted as "leaked".
- b. If the check valve is closed tight, the gauge will read approximately 6 psi minimum to 10 psi maximum. If the check valve leaks, the gauge will read the same as step d., test no. 1.

Test No. 3

Purpose: To test No. 2 check valve for tightness against reverse flow.

Requirement: Valve must be tight against reverse flow under all pressure differentials.

Steps:

- a. Install a bypass hose from test cock #2 through a control valve to test cock #4.

b. Open test cock #4 and control valve. If water is discharged from the pressure differential relief valve, the #2 check valve shall be noted in the report as "leaked". If no water is discharged, the check valve shall be noted as "closed tight". Remove all test equipment and return gate valves to original setting.

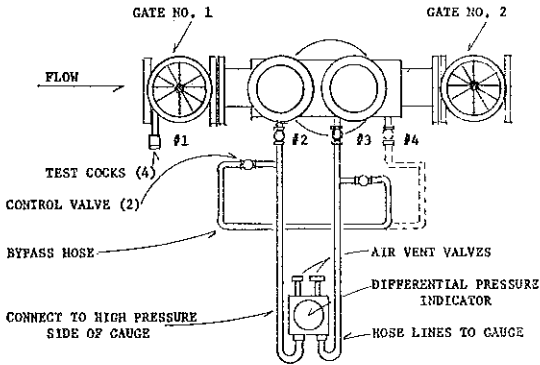

TESTING DIAGRAM

DIFFERENTIAL PRESSURE INDICATOR METHOD FOR REDUCED
PRESSURE BACKFLOW PREVENTERS

If this test is not performed by the local plumbing inspector, it must be performed by the company from whom the device was purchased. The owner shall have an agreement with the manufacturer's service representative or local plumbing inspector. A copy of the agreement and test reports shall be submitted to the department's district office. The district office shall be notified 3 days in advance by the owner or manufacturer's service representative when tests are to be conducted or scheduled repairs made. In addition to the annual test, the owner shall inspect the unit at least weekly for evidence of leakage through the relief valve port and submit monthly reports to the district office of the department. Defects found during inspection, testing or overhaul shall be corrected without delay.

2. Polyvinyl chloride (PVC) water distribution piping. a. Use limitations and specifications. Rigid PVC plastic pipe and fittings conforming to ASTM standard specifications D 2241-69 and 2466-69 may be used for potable cold water distribution systems in single family residences and mobile homes. Plastic used in the cold water distribution piping shall be of schedule 40, and shall have a pressure rating of not less than 200 psi at 73.4 degrees Fahrenheit. Plastic pipe, fittings, and solvent cement for rigid plastic pipe shall have received the seal of approval of the National Sanitation Foundation and all materials shall bear the stamped seal of approval. All plastic pipe and fittings shall be marked for identification purposes at intervals of not more than 5 feet and include the manufacturer's name or trademark, the ASTM designation, the SDR number, type of plastic, nominal size and the NSF seal of approval.

b. Approval shall be obtained from the department for each specific building prior to installation of the material. The request for approval

shall indicate the owner's name, type of building and street address. Installations not having prior approval by the department will be rejected.

3. Chlorinated Poly (vinyl chloride) (CPVC) plastic hot and cold water distribution piping. a. Use limitations and specifications. Rigid CPVC plastic pipe and fittings conforming to ASTM Standard specification D 2846-69T may be used for potable hot and cold water distribution piping systems in single family residences and mobile homes. CPVC plastic pipe and fittings shall not be used for hot water with temperatures exceeding 180° F. The CPVC plastic pipe and fittings used in the water distribution system shall have a pressure rating of not less than 200 psi at 73.4 degrees Fahrenheit. Plastic pipe, fittings, and solvent cement for rigid plastic pipe shall have received the seal of approval of the National Sanitation Foundation and all materials shall bear the stamp, seal of approval. All plastic pipe and fittings shall be marked to include the manufacturer's name or trademark, NSF seal of approval, ASTM D 2846-70, material designation, pressure rating, nominal size, the SDR number, the code number identifying the compound and date of manufacture.

b. Approval shall be obtained from the department for each specific building prior to installation of the material. The request for approval shall indicate the owner's name, type of building and street address. Installations not having prior approval by the department will be rejected.

4. Acid or corrosive waste piping systems. A written approval by the department shall be obtained prior to installation. A request shall be in writing by the architect, engineer or owner with 3 copies of the system piping diagram (schematic or isometric). Contact the department for approved materials.

5. Polyvinyl chloride (PVC) sewer pipe and fittings. a. Use limitations and specifications. Polyvinyl chloride (PVC) sewer pipe and fittings conforming to ASTM standards specifications D 3033-72 and D 3034-72 may be used for building sewer and private interceptor main sewer construction. The pipe shall be clearly marked at intervals of 5 feet or less with the manufacturer's name or trademark, nominal pipe size, the PVC cell classification (for example, 12454-B), the legend "type PSM PVC sewer pipe" (3034) or "type PSP SDR 41" (except 4 inch size shall be SDR 33.5 (3033) and the ASTM designation D 3033-72 or D 3034-72. Fittings shall be clearly marked with the manufacturer's name or trademark, nominal size, the material designation PVC, type PSM or PSP, and the ASTM designation.

b. PVC pipe and fittings shall be installed in accordance with ASTM recommended practices D 2321-72 and Wis. Adm. Code section H 62.04 (4) (f) 1. and (g).

c. Elastomeric gaskets for joint assembly shall meet all the requirements of ASTM C 443-70 and C 425-71 and be approved by the department.

d. The mixing of manufacturers' pipe or fittings is prohibited.

e. The building sewer and its relation to the water service pipe shall be installed in accord with Wis. Adm. Code section H 62.13.

6. No-Hub cast iron pipe and fittings. a. Use limitations. No-Hub cast iron pipe and fittings conforming to specifications set forth in

table 35 may be installed in lieu of materials specified in Wis. Adm. Code section H 62.05 (2) for building drains serving one and two family dwelling structures.

7. PVC or ABS perforated plastic pipe and fittings. a. Use limitations. PVC or ABS perforated plastic pipe and fittings conforming to specifications set forth in table 35 may be installed in lieu of materials specified in Wis. Adm. Code section H 62.20 for distribution piping for septic tank effluent soil absorption systems.

b. Identification. All pipe and fitting materials are to be identified as set forth in Wis. Adm. Code section H 62.19 (1) (b). Piping shall be marked at intervals of 5 feet or less and shall include the manufacturer's name or trademark, nominal size and the legend PVC or ABS sewer pipe.

c. Material specification. The PVC or ABS sewer pipe and fittings shall be manufactured in accord with the ASTM specifications indicated in table 35. The perforations in the plastic pipe shall be circular, $\frac{5}{8}$ inch plus or minus $\frac{1}{16}$ inch in diameter and arranged in two rows parallel to the axis of the pipe. The perforations shall be spaced approximately 3 inches center to center along the rows. These rows may be 90 to 125 degrees apart.

d. Solvent cement. The solvent cements used shall comply with the appropriate ASTM specification for PVC or ABS piping material.

e. Installation. The PVC or ABS plastic pipe and fittings shall be installed and subjected to the same installation criteria as set forth in Wis. Adm. Code section H 62.20.

8. Acrylonitrile-Butadiene-Styrene (ABS) composite sewer pipe and fittings.

a. Use limitations and specifications. ABS composite sewer pipe and fittings conforming to specification in table 35 may be used for building sewer and private interceptor main sewer construction. The pipe shall be marked at intervals not exceeding 5 feet in letters not less than $\frac{3}{8}$ inch in height and of bold type style. The markings shall indicate the name of the manufacturer, ASTM designation D 2680-70, ABS and the nominal diameter. Couplings and fittings shall be marked to indicate the name of the manufacturer, ASTM designation D 2680-70 and nominal diameter.

b. Installation. ABS composite pipe and fittings shall be installed in accordance with ASTM specification D 2321-72. The mixing of other manufacturers' pipe and fittings is prohibited. Joints shall be made by solvent welding according to manufacturer's recommendations and ASTM specification D 2680-70.

(b) The department may issue supplemental bulletins for table 35 for materials, designs or methods of installation not included in this section.

(c) The department shall review all materials listed in this section on an annual basis to determine the acceptability of the material for inclusion in table 32, Wis. Adm. Code section H 62.19, rejection of its use or continue its use on experimental basis because of insufficient use.

Table 35

Materials	See Limitations or Subsection H 62.24 (2) (a) Below	Standards and Specifications		
		ANSI	ASTM	Other
Reduced pressure zone principle type backflow preventers	1			
Polyvinyl chloride (PVC) (cold water distribution)	2		D2241-69 D2243-69 D3038-72 D3039-72	AWWA C506-69 NSF 14
Polyvinyl chloride (PVC) (building sewer)	5		D2846-69T	NSF 14
Chlorinated Poly (vinyl chloride) (CPVC) plastic (hot water distribution systems)	3			Departmental approval required for each product or system
Acid or corrosive waste piping systems	4			
Polyethylene	4			
Polypropylene	4			
Polyethylene	4			
Polyglass	4			
No-Hub cast iron (building drain)	4			
Acrylonitrile-butadiene-styrene (ABS) (perforated pipe)	6			Cast Iron Soil Pipe Institute 301-71
	7		D1788-68 D2751-71 D2235-67	
Acrylonitrile-butadiene-styrene (ABS) (composite sewer pipe and fittings)	8		D2680-68T	
Polyvinyl chloride (PVC) (perforated pipe)	7		D1784-69 D2729-71 D2864-67	

Note: Copies of standards promulgated by the following technical societies referred to above are on file in the offices of the secretary of state, health and social services, and revisor of statutes and may be obtained for personal use from the following addresses:

American Water Works Association
2 Park Avenue, New York, New York 10016

American Society for Testing and Material
1916 Race St., Philadelphia, Pa. 19103

Cast Iron Soil Pipe Inst.
2029 K St. NW
Washington, D. C. 20006

National Sanitation Foundation
Testing Laboratory, Inc., P. O. Box 1468
Ann Arbor, Michigan 48106

History: Cr. Register, November, 1972, No. 203, eff. 12-1-72.

