

# **Wisconsin Administrative Code**

**Rules of**

**DEPARTMENT OF INDUSTRY,  
LABOR AND HUMAN  
RELATIONS**

**PLUMBING**

**Cite the rules in this Code as**

**(for example)**

**s. ILHR 81.01, Wis. Adm. Code**

**DEPARTMENT OF INDUSTRY, LABOR AND  
HUMAN RELATIONS**

**201 East Washington Avenue**

**Madison, Wisconsin 53702**

**608-266-3815**

## INTRODUCTION

### Purpose and Structure

The legislature, by s. 35.93 and ch. 227, Stats., directed the publication of the rules of administrative agencies having rule-making authority in a loose-leaf, continual revision system known as the Wisconsin Administrative Code. The code is kept current by means of new and replacement pages. The pages are issued monthly, together with notices of hearings, notices of proposed rules, emergency rules, new rules, instructions for insertion of new material, and other information relating to administrative rules. This service is called the Wisconsin Administrative Register, and comes to the subscriber after the 10th and the 25th of each month. Code pages are issued to subscribers only with the end of the month Register. The editing and publishing of the Register and Code is done by the Revisor of Statutes Bureau, 411 W. State Capitol, Madison, Wisconsin, 53702. (608-266-7275).

### Availability

The complete code and the upkeep service are distributed to the county law libraries; to the libraries of the University of Wisconsin Law School and Marquette University Law School; to the State Historical Society; to the Legislative Reference Bureau and to the State Law Library, and to certain designated public libraries throughout the state.

The sale and distribution of the Register, Code and of its parts is handled by Department of Administration, Document Sales and Distribution, 202 S. Thornton Ave., Madison, Wisconsin 53702. (608-266-3358)

### Table of Contents

Each code with more than one chapter will have a table of chapters. After the title of each chapter will be the page numbers on which the chapter begins. Each chapter will have a table of sections. When a chapter has more than 10 sections and is over 10 pages in length the page number which that particular section begins on will be inserted after the title of the section.

### History Notes

Each page of the code as it was originally filed and printed pursuant to the 1955 legislation, is dated "1-2-56". A rule which is revised or created subsequent to the original printing date is followed by a history note indicating the date and number of the Register in which it was published and the date on which the revision or creation of the rule became effective. The absence of a history note at the end of a section indicates that the rule has remained unchanged since the original printing in 1956. The date line at the bottom of the page indicates the month in which the page was released. Some common abbreviations used in the history notes are: cr. - created, am. - amend, r. - repeal, recr. - recreate, renum. - renumber, eff. - effective and emerg. - emergency.

In some instances an *entire* chapter has been repealed and recreated or renumbered subsequent to the original printing date. When this occurs a history note has been placed at the beginning of the chapter to contain this information. A separate history note appears after each section indicating the date when the revision became effective.

### Index

The index for the complete Wisconsin Administrative Code will be found in the last volume. It will be recompiled, reprinted and distributed annually. Some codes have a separate index prepared by the agency involved. See the Building and Heating Code (chs. ILHR 50-64) for an example.



## TABLE OF CONTENTS

*Chapter*

ILHR 81	Apprenticeships, licensures, registrations and certificates (p. 1)
ILHR 82	Design, construction, installation, supervision and inspection of plumbing (p. 39)
ILHR 83	Private sewage systems (p. 259)
ILHR 84	Plumbing fixtures and materials (p. 377)
ILHR 85	Subdivisions not served by public sewers (p. 423)
ILHR 86	Boat and on-shore sewage facilities (p. 447)



Chapter ILHR 81

APPRENTICESHIPS, LICENSURES, REGISTRATIONS AND  
CERTIFICATIONS

<b>SUBCHAPTER I — Apprenticeships, Licensures and Registrations</b>		ILHR 81.302	Scope (p. 23)
ILHR 81.001	Purpose (p. 1)	ILHR 81.304	Certification processing times (p. 23)
ILHR 81.002	Scope (p. 2)	ILHR 81.31	Definitions (p. 23)
ILHR 81.004	Permit processing times (p. 2)	ILHR 81.32	Administration and enforcement (p. 25)
ILHR 81.01	Definitions (p. 2)	ILHR 81.33	Authority (p. 25)
ILHR 81.02	Plumbing apprenticeship (p. 3)	ILHR 81.34	Inspector certification (p. 26)
ILHR 81.03	Registered learners (p. 6)	ILHR 81.35	Independent inspection agency certification — in-plant inspections (p. 28)
ILHR 81.04	Qualifications for licensure examinations (p. 8)	ILHR 81.36	Independent inspection agency certification — on-site inspections (p. 30)
ILHR 81.05	Plumbing licensure examinations (p. 8)	ILHR 81.37	Suspension or revocation of certification (p. 31)
ILHR 81.06	Temporary permits (p. 10)	ILHR 81.38	Certification fees (p. 33)
ILHR 81.07	Exchange of licenses without examination (p. 10)	ILHR 81.39	Petition for rules or declaratory rulings (p. 33)
ILHR 81.08	Plumber licensure-retiree (p. 11)	ILHR 81.40	Private sewage system inspections (p. 33)
ILHR 81.09	Utility contractor license and registration of pipe layers (p. 11)	<b>SUBCHAPTER III — Certification of Soil Testers</b>	
ILHR 81.10	Licensing of automatic fire sprinkler fitters and contractors (p. 12)	ILHR 81.601	Scope (p. 33)
ILHR 81.11	Registration for the maintenance of automatic fire sprinklers (p. 15)	ILHR 81.603	Certification processing times (p. 34)
ILHR 81.12	Expiration of licenses and registrations (p. 17)	ILHR 81.61	Definitions (p. 34)
ILHR 81.13	License and registration renewal (p. 18)	ILHR 81.62	Reports (p. 34)
ILHR 81.14	Suspension and revocation of licenses (p. 19)	ILHR 81.63	Examining committee (p. 34)
ILHR 81.15	Suspension and cancellation of registrations (p. 20)	ILHR 81.64	Application and examination (p. 35)
ILHR 81.16	Examination, licensure and registration fees (p. 20)	ILHR 81.65	Issuance of certificate (p. 36)
<b>SUBCHAPTER II — Certification of Plumbing Inspectors</b>		ILHR 81.66	Renewal of certificate; delinquency and reinstatement (p. 36)
ILHR 81.301	Purpose (p. 23)	ILHR 81.67	Revocation or suspension of certificate (p. 36)

Note: Chapters H 61 and 64 as they existed on April 30, 1983 were repealed and a new chapter ILHR 81 was created effective May 1, 1983.

**SUBCHAPTER I — APPRENTICESHIPS, LICENSURES AND REGISTRATIONS**

**ILHR 81.001 Purpose.** The purpose of this subchapter is to protect the health of the public by establishing minimum standards as to the qualification, activities and responsibilities of persons engaging or offering to engage in plumbing work or the installation of automatic fire sprinkler systems.

## ILHR 81

**ILHR 81.002 Scope.** The provisions of this subchapter apply to any person engaging or offering to engage in the construction, installation or maintenance of plumbing or automatic fire sprinkler systems.

**History:** Cr. Register, April, 1983, No. 328, eff. 5-1-83.

**ILHR 81.003 Saving and severable clauses.** **History:** Cr. Register, April, 1983, No. 328, eff. 5-1-83; r. under s. 13.93 (2m) (b) 16, Stats., Register, February, 1985, No. 350.

**ILHR 81.004 Permit processing times.** Licenses, permits and registrations issued under this subchapter shall be granted or denied by the department within 30 business days after passage of examination or receipt of the applicable application and fees.

**History:** Cr. Register, February, 1985, No. 350, eff. 3-1-85.

**ILHR 81.01 Definitions.** For the purpose of this subchapter, the following terms are defined:

- (1) "Approved" means acceptable to the department.
  - (2) "Automatic fire sprinkler contractor" means an individual, firm or corporation as defined in s. 145.01 (9), Stats.
  - (3) "Automatic fire sprinkler fitter" means a person as defined in s. 145.01 (10), Stats.
  - (4) "Automatic fire sprinkler system" means an installation as defined in s. 145.01 (8), Stats.
  - (5) "Automatic fire sprinkler system apprentice" means a person as defined in s. 145.01 (11), Stats.
  - (6) "Business establishment" means any industrial or commercial organization or enterprise operated for profit, including but not limited to a proprietorship, partnership, firm, business trust, joint venture, syndicate, corporation or association.
  - (7) "Department" means the bureau of plumbing within the department of industry, labor and human relations.
  - (8) "Gross negligence" means a high degree of failure to exercise ordinary care of judgement and failure by omission or commission to discharge the duty required to protect the public health, safety and welfare.
  - (9) "Incompetence" means conduct which evidences a lack of competence or ability to discharge the duty required to protect the health, safety and welfare of the public, lack of knowledge of the fundamental principles of plumbing or an inability to apply those principles, or failure to maintain competency in the current practices and methods applicable to plumbing and the state uniform plumbing code.
  - (10) "Journeyman plumber" means a person as defined in s. 145.01 (3), Stats.
  - (11) "Master plumber" means a person as defined in s. 145.01 (2), Stats.
  - (12) "Misconduct" means an act performed in the discharge of enforcement duties which jeopardizes the interests of the public, including violation of federal or state laws, local ordinances or administrative rules relating to the position; preparation of deficient or falsified reports; fail-
- Register, February, 1985, No. 350

ure to submit information or reports required by law or contract when requested by the municipality or the department; conduct which evidences a lack of trustworthiness; misrepresentation of qualifications such as education, experience or certification; illegal entry of premises; misuse of funds; or misrepresentation of authority.

(13) "Pipe layer" means a person as defined in s. 145.01 (13), Stats.

(14) "Plumbing" means an installation as defined in s. 145.01 (1), Stats.

(15) "Plumbing apprentice" means a person as defined in s. 145.01 (4), Stats.

(16) "Registered learner" means a person as defined in s. 145.01 (7), Stats.

(17) "Restricted plumber licensee" means a person as defined in s. 145.01 (6), Stats.

(18) "Utility contractor" means a person as defined in s. 145.01 (12), Stats.

History: Cr. Register, April, 1983, No. 328, eff. 5-1-83.

**ILHR 81.02 Plumbing apprenticeship.** (1) **QUALIFICATIONS FOR REGISTRATION.** All applicants for registration as plumbing apprentices shall have reached the age of 16 years and shall have completed the 12th grade in school or its equivalent.

(2) **REGISTRATION.** Every plumbing apprentice shall register with the department immediately. Registration forms shall be furnished by the department which shall require the applicants to indicate their name, age, preliminary schooling, beginning date of indenture, name and address of employer and such other information as the department may require. Persons beginning an accredited plumbing trade school approved by the department may also register.

(3) **RESPONSIBILITY OF EMPLOYER.** (a) Registration as a plumbing apprentice may not be accepted unless the particular shop in which the apprentice is to work and the employing master plumber are equipped and qualified to have an apprentice and that the requirements as to both shop and school training will be complied with. All changes in relation to the continued employment of plumbing apprentices shall be subject to the joint approval of the divisions of the department of industry, labor and human relations having jurisdiction.

(b) Master plumbers employing plumbing apprentices shall be owners or co-owners with a monetary interest in a firm or corporation engaged in the installation of plumbing. Master plumbers in the employ of state agencies shall be considered employing master plumbers for the purpose of this section. Master plumbers shall be licensed by this state.

(4) **SUSPENSION OF REGISTRATION.** (a) Whenever a plumbing apprenticeship ceases to exist or whenever a registration is accepted under such conditions as would not warrant an acceptance if the facts are presented, or when there is willful noncompliance with the shop and school training requirements, the department shall suspend such registration until the conditions are remedied or shall cancel such registration, if necessary.



(b) A registration which has lapsed either through suspension or cancellation may be renewed in the same manner as new registrations and the department may grant such credit toward completion of the 4-year apprenticeship as it may deem proper in each case.

(5) PLUMBING INSTRUCTION. A plumbing apprentice's education shall include both day school and night school instruction.

(a) *Day school instruction.* Unless a graduate of an accredited plumbing trade school approved by the department, a plumbing apprentice shall complete a minimum of 400 hours of day school in plumbing related instruction.

1. All day school courses shall be approved by the department and the state joint apprenticeship committee.

2. The 400 hours of day school shall include instruction in:

- a. The state uniform plumbing code;
- b. Related plumbing science; and
- c. Plumbing trade mathematics.

3. The 400 hours of day school instruction shall include at least 36 hours per year in each of the following:

- a. Related plumbing science; and
- b. Plumbing trade mathematics.

4. All day school courses shall include a final written competency examination.

a. Competency examinations shall be approved by the department and the state joint apprenticeship committee.

b. In order to receive the hourly credit for a day school course, a plumbing apprentice shall successfully pass the course's final competency examination.

c. In order to pass a competency examination, a grade of 75% or greater shall be obtained.

d. Failure to pass a competency examination shall necessitate the plumbing apprentice to repeat the day school course in order to receive credit for the course.

e. The results of the competency examinations shall be immediately forwarded to the apprenticeship and training division of the department of industry, labor and human relations.

Note: The mailing address for the apprenticeship and training division is:

APPRENTICESHIP AND TRAINING DIVISION  
Department of Industry, Labor and Human Relations  
P.O. Box 7946  
Madison, WI 53707

(b) *Night school instruction.* A plumbing apprentice shall complete a minimum of 180 hours of night school instruction.

1. All night school courses shall be approved by the department and the state joint apprenticeship committee.

2. Every night school course shall include a final examination.
  - a. Final examinations shall be approved by the department.
  - b. Completion of each night school course shall be contingent upon the successful passage of the final examination.
  - c. The minimum passing grade for a final examination shall be established by the state joint apprenticeship committee.
  - d. Failure to pass a final examination shall necessitate the plumbing apprentice to repeat the night school instruction in order to receive credit for the course.
  - e. The results of the final examinations shall be immediately forwarded to the apprenticeship and training division of the department of industry, labor and human relations.

Note: The mailing address for the apprenticeship and training division is:

APPRENTICESHIP AND TRAINING DIVISION  
Department of Industry, Labor and Human Relations  
P.O. Box 7946  
Madison, Wisconsin 53707

3. The 180 hours of night school shall include instruction in:
  - a. Welding;
  - b. First aid;
  - c. Transit;
  - d. Domestic water heating;
  - e. Related plumbing science;
  - f. Blueprint reading;
  - g. Basic properties of water including water conditioning;
  - h. State uniform plumbing code; or
  - i. Miscellaneous subjects whose courses have been requested by the local joint apprenticeship committee and approved by the department and the state joint apprenticeship committee.
4. Every plumbing apprentice shall complete night school courses in welding, first aid and transit.
5. Credit toward the required minimum 180 hours of night school instruction shall not include more than:
  - a. Sixty hours of courses in welding;
  - b. Fifteen hours of courses in first aid; and
  - c. Twenty hours of courses in transit.

(6) PRACTICAL TRAINING. A plumbing apprentice shall receive practical training in all phases of plumbing.

(a) *First 3 years.* During the first 3 years of apprenticeship plumbing apprentices shall be given the opportunity to install plumbing material

## ILHR 81

as their skill may permit under the immediate supervision of a journeyman or master plumber licensed in Wisconsin.

(b) *Fourth year.* During the fourth year of apprenticeship plumbing apprentices may make plumbing installations as their acquired skill will permit under general supervision of a master plumber licensed in Wisconsin.

History: Cr. Register, April, 1983, No. 328, eff. 5-1-83.

**ILHR 81.03 Registered learners.** (1) **QUALIFICATION FOR REGISTRATION.** All applicants for registration as registered learners shall have reached the age of 16 years and shall have completed the 12th grade in school or its equivalent.

(2) **REGISTRATION.** Pursuant to s. 145.07 (7) (a), Stats., every plumbing learner shall register with the department. Registration forms shall be furnished by the department which shall require the applicants to indicate their name, age, schooling, beginning date of employment, name and address of employer, work classification and such other information as the department may require.

Note: See s. 145.14 (2), Stats., for type of work classifications and the work permitted under each.

(3) **RESPONSIBILITY OF EMPLOYER.** (a) Registration as a registered learner may not be accepted unless the particular organization in which the learner is to work and the master plumber or master plumber-restricted are equipped and qualified to train a learner in the specific restricted classifications for which the learner is requesting registration. Master plumbers or master plumbers-restricted supervising registered learners shall see that the requirements as to both shop and school training will be complied with, and shall report to the department any changes made in relation to the continued employment of such learners. Such changes shall be subject to the approval of the department.

(b) In the particular organization in which the registered learner is to work, there shall be at least one master plumber or master plumber-restricted. For each registered learner there shall be at least one journeyman plumber or journeyman plumber-restricted. For this purpose, a master plumber or master plumber-restricted may act as a journeyman plumber or a journeyman plumber-restricted, respectively.

(4) **SUSPENSION OR CANCELLATION OF REGISTRATION.** (a) Whenever the employment of a registered learner is terminated or whenever a registration is accepted under such conditions as would not warrant an acceptance if the facts are presented, or when there is willful noncompliance with the shop and school training requirements, the department shall suspend such registration until the conditions are remedied or shall cancel such registration, if necessary.

(b) A registration which has lapsed either through suspension or cancellation may be renewed in the same manner as a new registration and the department may grant such credit toward completion of the 1-year learner program as it may deem proper in each case.

(c) A person's registration as a registered learner shall be cancelled if the registrant has not completed the plumbing instruction requirements of sub. (5) and has not applied and taken the initial examination for a

journeyman plumber-restricted license within 18 months from the date of learner registration.

(d) A person whose learner registration is cancelled shall consult with the department and obtain department approval before re-registering. The department may permanently cancel a learner's registration.

(5) **PLUMBING INSTRUCTION.** Unless a graduate of an accredited plumbing trade school approved by the department, a registered learner shall complete a minimum of 100 units of educational credit in plumbing related instruction.

(a) All educational courses and their corresponding units of credit shall be approved by the department.

1. All approved courses shall be set up in a competency based instruction format.

2. Courses may be taken through a correspondence format with the approval of the department.

3. All approved courses shall include a final examination.

4. Completion of an approved course shall be contingent upon the successful passage of the final examination.

5. In order to pass a final examination, a grade of 75% or greater shall be obtained.

6. Failure to pass a final examination shall necessitate the registered learner to repeat the course.

a. Failure of a final examination shall result in the probation of a learner's registration for a period of not more than one year.

b. A second failure in the final examination of the same course shall result in the cancellation of a learner's registration.

7. The results of the final examinations shall be immediately forwarded to the department.

(b) A registered learner in a sewer service classification shall obtain a minimum of 100 units of educational credit in the courses specified in Table 81.03-1.

**TABLE 81.03-1**  
**REGISTERED LEARNER-SEWER SERVICE**

Subject Areas	Minimum Educational Credits in Units
State Uniform Plumbing Code	40
Blueprint Reading	20
Transit or Builder's Level	10
Construction Related Mathematics	20
First Aid and Safety	10
Other Approved Substitute Subjects	(As permitted by the department)

## ILHR 81

(c) A registered learner in an appliances, equipment and devices classification shall obtain a minimum of 100 units of educational credit in the courses specified in Table 81.03-2.

TABLE 81.03-2

REGISTERED LEARNER-APPLIANCE, EQUIPMENT  
AND DEVICES

Subject Areas	Minimum Educational Credits in Units
State Uniform Plumbing Code	40
Blueprint Reading	20
Plumbing Related Mathematics	10
Appliance & Equipment Servicing	30
Other Approved Substitute Subjects	(As permitted by the department)

(6) **PRACTICAL TRAINING.** The learner shall receive instruction and experience in all branches of the type of plumbing as restricted under registration. The learner shall be given the opportunity to install plumbing materials as the learner's skill will permit under the specific registration. All work shall be performed under the immediate supervision of a journeyman or master plumber or journeyman plumber or master plumber-restricted, licensed in Wisconsin.

History: Cr. Register, April, 1983, No. 328, eff. 5-1-83.

**ILHR 81.04 Qualifications for licensure examinations.** (1) **GENERAL.** Applicants for examination for licensure as a master plumber, master plumber-restricted, journeyman plumber, or journeyman plumber-restricted shall comply with the qualification requirements specified in s. 145.07, Stats.

(2) **MASTER PLUMBER APPLICANTS.** A person who has acquired a journeyman plumber license from the department and who has obtained, in less than 3 years from the acquisition date of the journeyman plumber license, a master plumber license from another state or a municipality outside the state shall acquire at least 1,000 hours of experience per year for 3 or more consecutive years as a licensed plumber to be eligible for licensure examination as a Wisconsin master plumber.

(3) **ENGINEERING GRADUATES.** Engineering graduates of an approved engineering school or college who are applying for examination for licensure as a master plumber shall have received a degree in civil engineering, mechanical engineering, agricultural engineering or other approved engineering curriculum related to plumbing. Such applicants shall submit their college transcripts to the department along with their licensure applications. Department acceptance of such applications shall be contingent upon the approval of the applicant's college transcripts.

History: Cr. Register, April, 1983, No. 328, eff. 5-1-83.

**ILHR 81.05 Plumbing licensure examinations.** (1) **GENERAL.** Not less than 4 examinations for the licensing of journeyman and master plumbers and journeyman plumber and master plumbers-restricted shall be conducted annually at such time and place as the department may direct. Application forms for examination for licensure may be obtained from the department.

Register, February, 1985, No. 350

(2) **APPLICATIONS.** (a) All applications for licensure examination shall be received by the department at least 4 weeks prior to the date of the examination. Failure to have the application on file with the department within the required time shall necessitate postponement of the applicant's appearance to the next examination.

(b) All applications shall expire after a period of one year from the date of filing.

(c) All applicants for licensure examinations shall submit the appropriate proof of experience, skill and proof of completion of the required educational instruction as required by either s. ILHR 81.02 (5) or 81.03 (5) including, but not limited to, grades for competency examinations and course examinations.

Note: See s. ILHR 81.04 and ss. 145.07 and 145.09, Stats., for the types of experience, skill and instruction required.

(3) **FEES.** Fees for the examinations are regulated by s. 145.08, Stats. Fees for licensure examination shall be nonrefundable.

(4) **NOTICE OF EXAMINATION TO APPLICANTS.** Notice of the time and place of examination shall be sent by first class mail to those who have approved applications on file. Such notice shall be mailed to the address given on the application form and shall be presented by the applicant to gain admittance to the examination room. Failure to receive the notice due to change in address shall not be the responsibility of the department.

(5) **NONATTENDANCE AT EXAMINATION.** Failure to appear at a scheduled licensure examination without giving prior notice to the department shall necessitate the submittal of a reexamination fee in order to maintain a valid examination application.

(6) **CHARACTER OF EXAMINATIONS.** (a) The examination shall be conducted by the plumbers' council. The examination shall consist of written and practical tests. No oral examinations shall be given. The examination shall cover the theory and practice of plumbing, the interpretation of charts, blueprints and plans of plumbing installations, and such other tests as the committee may deem necessary.

(b) Examinations shall consist of the following:

1. Written work based on the state uniform plumbing code;
2. Chart work based on the state uniform plumbing code; and
3. Practical plumbing work.

(c) Applicants shall participate in all portions of examination and shall acquire a passing grade in each portion to become eligible for licensure. A grade of 75% or greater in each portion shall be considered a passing grade.

(d) The department may conduct oral reviews with applicants after completion of the examination.

(7) **MATERIALS USED IN EXAMINATION.** Applicants shall furnish the necessary tools and material for the examination as requested by the examiners.

## ILHR 81

(8) **REEXAMINATION.** (a) Qualified applicants failing a licensure examination may apply for reexamination in accordance with the procedures of sub. (2).

(b) Qualified persons who fail the licensure examination for a journeyman plumber or journeyman plumber-restricted and who are no longer indentured apprentices or registered learners may apply for reexamination in accordance with the procedures of sub. (2) only once in a calendar year.

Note: Pursuant to ss. 145.03, 145.06, and 145.14, Stats., after the expiration of an apprenticeship term or a learner's registration term, no apprentice or registered learner may engage in or work at plumbing, unless the person secures a journeyman plumber license, a journeyman plumber-restricted license or is re-indentured as an apprentice or is re-registered as a learner.

(c) Applicants failing a licensure examination shall be reexamined only in those portions failed.

(9) **APPLICATION FOR LICENSE.** An applicant who has successfully passed a licensure examination may submit an application for the appropriate license within 60 days from the date the department has mailed the examination results. Failure to apply for a license within this time period shall necessitate reexamination.

History: Cr. Register, April, 1983, No. 328, eff. 5-1-83.

**ILHR 81.06 Temporary permits.** The department may issue a temporary permit upon receipt of a completed application and the appropriate fee for a qualified person to engage in plumbing work as a master plumber, master plumber-restricted, journeyman plumber or journeyman plumber-restricted. Applicants for temporary permits shall comply with all other applicable rules and statutes.

(1) **SPECIAL EXAMINATION.** (a) The department shall require passage of a special examination to determine the qualifications of an applicant before a temporary permit may be issued.

(b) Special examinations for temporary permits shall be conducted in accordance with s. ILHR 81.05 (6).

(2) **EXPIRATION.** Temporary permits shall become void upon the date of the first corresponding licensure examination following issuance of a temporary permit and shall be surrendered to the department.

(3) **LIMITATIONS.** Not more than 2 temporary permits shall be issued to an individual in any 12-month period.

History: Cr. Register, April, 1983, No. 328, eff. 5-1-83.

**ILHR 81.07 Exchange of licenses without examination.** All master plumbers or master plumbers-restricted in good standing and currently licensed by the department who work as journeyman plumbers or journeyman plumbers-restricted may, upon application and upon payment of the appropriate initial license fee, be issued either journeyman plumber licenses or journeyman plumber-restricted licenses, respectively, without licensure examination. A currently licensed journeyman plumber or journeyman plumber-restricted who has renewed a master plumber's license within 5 years preceding the date of application for exchange, may be relicensed as either a master plumber or master

plumber-restricted, respectively, upon the payment of the renewal fee and without licensure examination.

History: Cr. Register, April, 1983, No. 328, eff. 5-1-83.

**ILHR 81.08 Plumber license-retiree.** The department may issue to a person who has a valid license as a master plumber, master plumber-restricted, journeyman plumber or journeyman plumber-restricted and who is at least 62 years old or is physically unable to carry out the responsibilities of the profession, a plumber's license designated as retiree for the respective category.

(1) **ISSUANCE.** A plumber license-retiree shall be issued upon receipt of a completed application and the fee as specified in s. ILHR 81.16.

(2) **EXPIRATION.** A plumber license-retiree shall not have an expiration date, but may be suspended or revoked as specified in s. ILHR 81.14.

(3) **RESTRICTION.** A person holding a plumber license-retiree may not engage or offer to engage in any plumbing work except that which is permitted under s. 145.06 (4), Stats.

(4) **RENEWAL.** A person holding a plumber license-retiree may renew their old active license without licensure examination provided the appropriate license renewal fee as specified in s. ILHR 81.16.

History: Cr. Register, April, 1983, No. 328, eff. 5-1-83.

**ILHR 81.09 Utility contractor license and registration of pipe layers.** (1) **PROOF OF EXPERIENCE.** Proof of experience and skill in the planning, superintending and practical installation shall be provided by all persons making application for a utility contractor license. The application shall be presented to the department on forms provided by the department. The application shall be accompanied by the appropriate license fee specified in s. ILHR 81.16. In addition, the following documents shall be provided to the department:

(a) At least 2 letters from municipalities, or metropolitan sewage districts, where utilities were installed, or an architect or engineer, evidencing skill in the planning, superintending and practical installation of sanitary sewers, storm sewers or water service piping installations;

(b) An indication of the length of skilled utility contracting experience;

(c) A description of all related experience and training of the person seeking licensure; and

(d) A document providing such other information the department may require.

(2) **APPLICATION AND QUALIFICATION.** (a) All applicants for a utility contractor license, if not self-employed, shall provide the name of their employer.

(b) Should the licensed utility contractor leave the employ of a utility contracting firm, the firm may not be qualified to do business as a utility contracting firm after 30 days unless another employe becomes licensed as a utility contractor.



(3) **REGISTRATION.** The person who qualifies a utility contracting firm shall register with the department, on forms furnished by the department.

(4) **PIPE LAYERS.** The utility contractor shall be responsible for employing registered pipe layers.

(a) *Registration.* The utility contractor shall submit the names of employees to be registered as pipe layers with the department. Registration forms shall be furnished by the department. The name, age, education, beginning date of employment of each pipe layer and such other information as the department may require shall be submitted.

(b) *Qualifications for registration.* All applicants for registration as pipe layers shall be at least 18 years of age.

History: Cr. Register, April, 1983, No. 328, eff. 5-1-83.

**ILHR 81.10 Licensing of automatic fire sprinkler fitters and contractors.**

(1) **APPRENTICESHIP.** (a) *General.* The department may determine and prescribe the conditions under which any person may serve an automatic fire sprinkler system apprenticeship. Credit shall be granted for educational and training programs approved by the department. Every person, regardless of age, commencing an automatic fire sprinkler system apprenticeship after July 1, 1973, shall be indentured under ch. 106, Stats. The term of an automatic fire sprinkler system apprentice shall be 4 years, but the department may upon application of the apprentice or the apprentice's employer or both, extend the term, but an extension shall not exceed one year. After expiration of an apprenticeship term no apprentice may engage in the business of automatic fire sprinkler system work either as an apprentice or as journeyman automatic fire sprinkler fitter unless after the expiration of the apprenticeship term the apprentice secures a journeyman automatic fire sprinkler fitter's license. In case of failure to pass the examination for the license, the apprentice may continue to serve as an apprentice but not beyond the time for reexamination for a journeyman automatic fire sprinkler fitter's license, as prescribed in sub. (4) (f).

(b) *Registration.* Every automatic fire sprinkler system apprentice shall register with the department within 30 days after beginning the apprenticeship. Registration forms shall be furnished by the department. All applicants shall indicate their name, age, preliminary schooling, beginning date of indenture, name and address of employer and such other information as the department may require.

(c) *Qualifications.* All applicants for registration as apprentices shall have reached the age of 16 years and have completed the 12th grade in school or its equivalent. Applicants who have not completed the 12th grade or its equivalent shall attend part-time school at least 4 hours per week during the entire period of their apprenticeship or until such time the apprentice graduates from 12th grade.

(d) *Practical training.* 1. The apprentice shall receive instruction and experience in all branches of automatic fire sprinkler system installations.

2. During the first 2 years of apprenticeship, the apprentice shall be given the opportunity to install automatic fire sprinkler system material as the apprentice's skill permits. The apprentice shall be under the immediate supervision of a journeyman automatic fire sprinkler fitter.

diate supervision of a journeyman automatic fire sprinkler fitter licensed in Wisconsin.

3. During the third and fourth years of apprenticeship an apprentice may, under general supervision of a licensed journeyman automatic fire sprinkler fitter, make only those automatic fire sprinkler system installations as the apprentice's skill permits.

(e) *School credits.* Apprentice applicants who have attended accredited trade school courses in automatic fire sprinkler systems may receive up to 6 months credit toward their apprenticeship for each school year completed. Any attendance of less than one year may not receive recognition.

(f) *Responsibility of employer.* The contractor for whom the apprentice is to work shall be equipped and qualified to train apprentices. Shop and school training requirements established in s. 106.01 (5) (d), Stats., shall be met. Any changes made in relation to the continued employment and training of apprentices shall be reported to the department.

(g) *Suspension.* If an apprenticeship ceases to exist, if registration is accepted with incomplete or inaccurate information, or if willful non-compliance with the shop and school training requirements exists, the department shall suspend a registration until the deficiencies are remedied. The department may cancel registration. A registration which has lapsed either through suspension or cancellation may be renewed in the same manner as new registrations. The department may grant credit toward completion of the 4-year apprenticeship.

(2) **JOURNEYMAN AUTOMATIC FIRE SPRINKLER FITTER LICENSE.** (a) *Application.* Application for a journeyman automatic fire sprinkler fitter license shall be made on forms provided by the department.

(b) *Proof of experience.* Proof of experience, skill and related instruction shall be provided by all applicants for licenses as part of the application. Proof shall consist of a completed accredited apprenticeship program in automatic fire sprinkler systems installation or a list of 5 installations installed in a one-year period prior to March 1, 1967, with the following items included for each specific installation listed:

1. Installation hours per job and number of sprinkler heads installed in each system. Sprinkler heads taken off domestic water supply shall not qualify;
2. A minimum of 1,000 hours per year engaged in automatic fire sprinkler systems installation; and
3. Other information the department may require.

(3) **AUTOMATIC FIRE SPRINKLER CONTRACTOR LICENSE.** (a) *Application.* Application for an automatic fire sprinkler contractor license shall be made on forms provided by the department.

(b) *Proof of experience.* Proof of experience, skill and background shall be provided by all applicants for an automatic fire sprinkler contractor license. Proof shall consist of a letter of past business contact from a general contractor, a customer, an architect or engineer and the approving agency, such as, but not limited to, an insurance company and a list of 5 installations of automatic fire sprinkler systems installed in a one-year period prior to March 1, 1967, with the following items included for each specific installation listed:

1. Installation hours per job and number of sprinkler heads installed in each system. Sprinkler heads taken off domestic water supply shall not qualify;

2. Approval agency for each installation listed; and

3. Other information the department may require.

(c) *Responsibility.* The individual making application or writing the examination for the automatic fire sprinkler contractor license shall be a principal or officer of the firm who shall be knowledgeable and responsible for the design, installation and certification of all automatic fire sprinkler systems or portions of systems installed by the licensed contractor.

(d) *Termination.* The individual who has qualified the contractor for licensure shall remain as a principal or officer of the firm. Upon separation of such individual for any reason from the contractor's employ, the firm shall be required to have the replacement show evidence of qualifications by application to the department. The change shall be registered with the department within 90 days. Where deemed necessary, the department may require a written or oral examination to evaluate the qualification of the replacement. An individual may qualify only one automatic fire sprinkler contracting firm at any one time.

(e) *Registration.* The automatic fire sprinkler contractor shall register with the department the principal or officer who qualifies the contractor for licensure on forms provided by the department.

(4) **EXAMINATIONS.** (a) *General.* At least 2 automatic fire sprinkler system examinations for the licensing of journeyman and contractors shall be conducted annually at such time and place as the department may direct. An apprentice shall be eligible to make application for examination 90 days prior to the expiration and completion date of the indentured apprenticeship. A license shall be issued upon receipt of a passing grade in the examination and expiration of the apprenticeship. Application forms for examination for licensure and renewal of licenses may be obtained from the department.

(b) *Date of filing application.* All applications for examination shall be received by the department at least 4 weeks prior to the date of examination. Failure to have the application on file with the department within the required time shall necessitate postponement of the applicant's appearance to the next examination. All applications shall expire after a period of one year from the date of filing.

(c) *Notice of examination.* Notice of the time and place of examination shall be sent by first class mail to those who have approved applications on file. Such notice shall be mailed to the address given on the application form and shall be presented by the applicant to gain admittance to the examination room. Failure to receive the notice due to change in address shall not be the responsibility of the department.

(d) *Character of examinations.* 1. The examination shall be conducted by the automatic fire sprinkler system contractors and journeymen council. The examinations shall consist of written tests and may be practical or oral in part. The examination shall cover the theory and practice of automatic fire sprinkler systems, the interpretation of charts, blueprints and plans of automatic fire sprinkler system installations, and such other tests as the committee may deem necessary.

2. Applicants shall participate in all portions of the examination and shall acquire a grade of 75% or greater to be eligible for licensure. Applicants who fail to acquire a passing grade shall be required to rewrite the complete examination.

(e) *Materials used in examination.* Applicants shall furnish the necessary tools and materials for the examination as requested by the examiners.

(f) *Reexamination.* Applicants failing an initial examination may be reexamined within 3 months. Applicants may not be eligible for a second reexamination until the expiration of 6 months after the first reexamination, and not for the third and subsequent reexaminations until the expiration of one year after the last reexamination.

(5) **TEMPORARY PERMITS.** Temporary permits shall become void upon the date of the first examination following issuance of the permit and shall be surrendered to the department. Not more than 2 temporary permits may be issued to an individual or contractor in any 12-month period, or not more than 3 temporary permits shall be issued in a 5-year period. Applicants for temporary permits shall comply with all other applicable rules and statutes.

(6) **ALLOWABLE MAINTENANCE.** The weekly or monthly testing of sprinkler alarm equipment, fire pumps, valves, or appurtenances; the refilling of storage and pressure tanks; or the replacement of automatic fire sprinkler heads under emergency conditions, shall not require licensure under ch. 145, Stats.

History: Cr. Register, April, 1983, No. 328, eff. 5-1-83; am. (1)(a), (d)2. and 3. and (g), Register, January, 1984, No. 337, eff. 2-1-84.

**ILHR 81.11 Registration for the maintenance of automatic fire sprinklers.**

(1) **GENERAL.** Unless a temporary permit is secured in accordance with sub. (4), a business establishment shall obtain a registration certificate from the department prior to initiating any repair or maintenance activities to an existing automatic fire sprinkler system within its facilities.

(2) **APPLICATION FOR REGISTRATION CERTIFICATE.** A business establishment applying for an automatic fire sprinkler maintenance registration certificate shall:

(a) Submit to the department a completed application on forms furnished by the department;

Note: Application for registration certificate is to be made on form SBD 6796.

(b) Submit to the department the registration fee specified in s. ILHR 81.16; and

(c) Employ at least one person:

1. Who is to be responsible for the repair and maintenance activities to the existing automatic fire sprinkler system; and

2. Who has demonstrated a knowledge of repairing and maintaining an automatic fire sprinkler system by passing a department examination.

(3) **DEPARTMENT EXAMINATION.** (a) At least 3 department examinations for a person of a business establishment which is seeking an auto-

matic fire sprinkler maintenance registration certificate shall be conducted annually at such time and place as the department may direct.

(b) All applications for examination shall be received by the department at least 4 weeks prior to the date of examination. Failure to have the application on file with the department within the required time shall necessitate postponement of the applicant's appearance until the next examination. All applications shall expire after a period of one year from the date of filing.

(c) An examination fee for each applicant shall be submitted to and received by the department prior to the date of the examination. Examination fees are specified in s. ILHR 81.16.

(d) Notice of the time and place of examination shall be sent by first class mail to those who have approved applications on file. Such notice shall be mailed to the address given on the application form and shall be presented by the applicant to gain admittance to the examination room. Failure to receive the notice due to change in address shall not be the responsibility of the department.

(e) Applicants shall participate in all portions of the examination. A grade of 75% or better is required in order to pass the examination. Applicants who fail to acquire a passing grade shall be required to rewrite the complete examination.

(4) **TEMPORARY PERMIT.** (a) *General.* Prior to obtaining an automatic fire sprinkler maintenance registration certificate, the department may issue a temporary permit to a business establishment to engage in the repair and maintenance activities specified in sub. (5) upon submission of:

1. A completed application for an automatic fire sprinkler maintenance registration certificate;
2. Satisfactory evidence documenting the knowledge of automatic fire sprinkler systems of the person responsible for the repair and maintenance activities; and
3. The temporary permit fee specified in s. ILHR 81.16.

(b) *Expiration.* A temporary permit shall be void upon the date of the first examination following issuance of the permit.

(5) **REPAIR AND MAINTENANCE ACTIVITIES.** A business establishment possessing a valid automatic fire sprinkler maintenance registration certificate or a temporary permit may, within its facilities:

(a) Replace or repair any component of an existing automatic fire sprinkler system including daily maintenance and emergency repairs to underground fire mains and fire pumps; and

(b) Modify or extend an existing automatic fire sprinkler system by no more than 15 sprinkler heads per project.

Note: Section ILHR 51.23 requires that all installed automatic fire sprinkler systems be maintained for efficient service as specified in NFPA No. 13A.

(6) **TERMINATION OF QUALIFYING PERSON.** If the person who is responsible for the repair and maintenance activities permitted under sub. (5) and who has qualified a business establishment for an automatic fire Register, February, 1985, No. 350

sprinkler maintenance registration certificate under sub. (2) (c) leaves the employment of the business establishment, the business establishment:

(a) Shall surrender to the department its automatic fire sprinkler maintenance registration certificate; and

(b) May apply for a new automatic fire sprinkler system registration certificate or a temporary permit.

(7) **FITTER MAINTENANCE REGISTRATION.** An employe of a business establishment possessing a valid automatic fire sprinkler maintenance registration certificate shall obtain from the department an automatic fire sprinkler fitter maintenance registration certificate before engaging in any of the repair or maintenance activities specified in sub. (5).

(a) *Limitations of registration certificate.* 1. A person possessing a valid automatic fire sprinkler fitter maintenance registration certificate may perform the repair and maintenance activities specified in sub. (5) for only one business establishment.

2. The automatic fire sprinkler fitter maintenance registration certificate shall indicate the specific business establishment for which a person may perform the repair and maintenance activities specified in sub. (5).

3. Upon the expiration, revocation or nonrenewal of the automatic fire sprinkler maintenance registration certificate of the business establishment, all automatic fire sprinkler fitter maintenance registration certificates issued under that business establishment shall become invalid.

(b) *Application.* A person seeking an automatic fire sprinkler fitter maintenance registration certificate shall submit to the department:

1. A completed application on forms furnished by the department; and

Note: Application for fitter registration certificate is to be made on form SBD 6796.

2. The registration certificate fee specified in s. ILHR 81.16.

(c) *Termination of employment.* If for any reason an employe possessing a valid automatic fire sprinkler fitter maintenance registration certificate leaves the employment of the business establishment for which the person may perform the repair and maintenance activities specified in sub. (5), the registration certificate shall expire on the day of termination.

(8) **REVOCAION OF CERTIFICATES.** Pursuant to s. ILHR 81.14, the department may revoke any automatic fire sprinkler maintenance registration certificate of a business establishment or any automatic fire sprinkler fitter maintenance registration certificate.

(9) **TESTING AND EMERGENCY REPAIRS.** The weekly or monthly testing of sprinkler alarm equipment, fire pumps, valves, or appurtenances; the refilling of storage and pressure tanks; or replacement of automatic fire sprinkler heads under emergency conditions, shall not require registration under this subchapter.

History: Cr. Register, April, 1983, No. 328, eff. 5-1-83.

**ILHR 81.12 Expiration of licenses and registrations.** No license or registration issued under this subchapter shall be valid for longer than one year and all licenses and registrations shall expire on December 31 of

## ILHR 81

each year. Licenses and registrations may be renewed upon application made prior to the date of expiration. The department may renew licenses upon application made after January 1, if it is satisfied that the applicant has good cause for not making application within the month of December and upon payment of the renewal and additional fees prescribed in s. ILHR 81.16.

History: Cr. Register, April, 1983, No. 328, eff. 5-1-83.

**ILHR 81.13 License and registration renewal.** (1) **ANNUAL NOTICE FOR RENEWAL OF LICENSES AND REGISTRATIONS.** Notice for the renewal of licenses and registrations issued under this subchapter shall be sent to all licensees and registrants whose licenses or registrations were in force during the previous year.

(a) A renewal notice shall be sent to the address given on the latest license or registration renewal form on file with the department.

(b) A licensee shall be responsible for notifying the department of any change in the licensee's mailing address.

(c) Failure to receive a notice for license or registration renewal shall not be an excuse for failure to renew.

(2) **RENEWAL APPLICATION.** License renewal shall be contingent upon the completion of the appropriate renewal application. The renewal application may include a department survey relative to the use of the applicant's license or registration. Failure to complete the survey shall result in the denial for renewal of a license or registration.

(3) **DELINQUENT OR ELAPSED LICENSES.** (a) *Plumber licenses.* 1. Master plumber and master plumber-restricted licenses shall be renewed within 5 years from the date of issuance. Failure to do so shall require reexamination to again qualify for licensure. Renewal of a delinquent or elapsed master plumber license or master plumber-restricted license that has not been renewed annually shall require the applicant to have a valid journeyman plumber license or journeyman plumber-restricted license, respectively. Upon the renewal of the master license, a licensee may exchange their license for the appropriate journeyman license in accordance with s. ILHR 81.07.

2. Journeyman plumber and journeyman plumber-restricted licenses shall be renewed every year. Failure to do so shall require reexamination to again qualify for licensure.

3. With respect to s. 145.05 (1), Stats., a person, who as a municipal plumbing inspector of a city of the first, second or third class, having a system of waterworks or sewerage, has not renewed their respective plumbing license annually, upon termination as a municipal plumbing inspector may renew their respective plumbing license without payment of a late renewal fee and without licensure re-examination, if a renewal application is submitted within the licensure year when termination occurs. Failure to do so shall require reexamination to again qualify for licensure. Municipal inspectors who do not renew their respective plumbing licenses annually may not engage in the installation of plumbing in accordance with s. 145.06, Stats.

(b) *Utility contractor licenses.* Whenever a person fails to renew a utility contractor license for a period of 3 years, the department shall require Register, February, 1985, No. 350

evidence to show that the renewal applicant is competent to perform the work of utility contractor before such license is renewed.

(c) *Automatic sprinkler licenses.* Whenever a person fails to renew a sprinkler fitter or contractor license for a period of 2 years, the department shall require evidence to show that the applicant for renewal is competent to perform the work of either a contractor or journeyman fire sprinkler fitter before such a license is renewed.

History: Cr. Register, April, 1983, No. 328, eff. 5-1-83.

**ILHR 81.14 Suspension and revocation of licenses.** Pursuant to ss. 145.10 and 145.17, Stats., the department may suspend or revoke the license of any master plumber, journeyman plumber, master plumber-restricted, journeyman plumber-restricted, utility contractor, automatic fire sprinkler contractor, or journeyman automatic fire sprinkler fitter.

(1) **GENERAL.** The department may suspend or revoke a license for any of the following reasons:

(a) The practice of fraud or deceit in obtaining a license;

(b) Gross negligence, incompetence or misconduct in the practice or work allowed by the license;

(c) Failure to correct an installation for which the licensee is responsible within the time prescribed by the department; and

Note: Section 145.10 (1) (b), Stats., indicates that the correction of an installation must take place within 30 days following notification by the department of a violation.

(d) Falsified information on an inspection form under s. 144.24 (10) (c), Stats.

(2) **INVESTIGATIONS.** The department may conduct an investigation of any alleged violations of this chapter or chs. ILHR 82 and 83. If it is determined that no further action is warranted, the department shall notify the persons affected. If the department determines that there is probable cause, it shall order a hearing and notify the persons affected.

(3) **SUMMARY SUSPENSION.** In accordance with s. 145.10 (1), Stats., the department may summarily suspend any license after providing not less than 10 days notice to the licensee, if it has reason to believe that the allegations in the complaints are justified. The summary suspension shall remain in effect until after a hearing finding is reached.

(4) **HEARINGS.** Hearings for the suspension or revocation of licenses shall be conducted as contested case hearings in accordance with ch. 227, Stats., and s. 145.10, Stats.

(5) **FINDINGS.** The department may make findings and enter its order on the basis of the facts revealed by its investigation. Any findings as a result of petition or hearing shall be in writing and shall be binding unless appealed to the secretary.

(a) *Suspension.* The period for suspension shall be determined by the hearing examiner or the department. The period for suspension may not exceed one year. A person whose license has been suspended may have the license reinstated by filing a new application for licensure and payment of the appropriate fee specified in s. ILHR 81.16.



## ILHR 81

(b) *Revocation.* The period for revocation shall be determined by the hearing examiner or the department. The period for revocation shall not exceed one year. A person whose license has been revoked shall be eligible for licensure only after the time set for revocation by department order has passed. A person whose license has been revoked may have the license reinstated only after submitting a completed application for licensure examination, payment of the examination fee, passing of the examination and payment of the license fee specified in s. ILHR 81.16.

History: Cr. Register, April, 1983, No. 328, eff. 5-1-83.

**ILHR 81.15 Suspension and cancellation of registrations.** The department may suspend or cancel the registration of any plumbing apprentice, registered learner, pipe layer, automatic fire sprinkler system apprentice, automatic fire sprinkler maintenance registration certificate or automatic fire sprinkler fitter maintenance registration certificate.

(1) **GENERAL.** The department may suspend or cancel a registration for any of the following reasons:

- (a) The practice of fraud or deceit in obtaining registration;
- (b) Failure to complete the apprenticeship or learner educational requirements of this subchapter;
- (c) Gross negligence, incompetence or misconduct in the practice or work allowed by the registration; and
- (d) Willful noncompliance with the apprenticeship or learner shop requirements needed to obtain registration.

(2) **COMPLAINTS TO APPRENTICESHIP AND TRAINING DIVISION.** The department may file a complaint with the apprenticeship and training division of the department of industry, labor and human relations regarding violations of this chapter or chs. ILHR 82 and 83 and request that action be taken to terminate or reassign the apprenticeship contract or agreement.

(3) **NOTICE OF SUSPENSION OR CANCELLATION.** Upon suspension or cancellation of any registration, the department shall notify the affected persons in writing stating the reasons for suspension or cancellation. The notice shall be made by affidavit of mailing or certified mail sent to the address filed with the application for registration.

(4) **HEARINGS.** Upon receipt of notice of registration, suspension or cancellation, the registrant may submit a written request for a contested case hearing in accordance with ch. 227, Stats. The right to hearing shall be considered waived, if the registrant fails to submit the request within 30 days after notice of registration, suspension or cancellation. Hearings shall be conducted by the department.

History: Cr. Register, April, 1983, No. 328, eff. 5-1-83.

**ILHR 81.16 Examination, licensure & registration fees.** (1) **MASTER PLUMBER.** The fees shall be as follows for master plumber:

- (a) *Examination fee.* Master plumber examination, \$50. Each subsequent examination, \$30.

Register, February, 1985, No. 350

(b) *License fee.* Master plumber license, \$75 and \$75 for each renewal of license, if application is made prior to January 1, annually; after that date an additional fee of \$20.

(c) *Temporary permit fee.* Temporary permit pending examination and issuance of license for master plumber, \$200. The fee shall cover the examination fee prescribed and the license fee for the year in which issued.

(2) **JOURNEYMAN PLUMBER FEES.** The fees shall be as follows for journeyman plumber:

(a) *Examination fee.* Journeyman plumber examination, \$30. Each subsequent examination, \$20.

(b) *License fee.* Journeyman plumber license, \$30 and \$30 for each renewal of license, if application is made prior to January 1, annually; after that date an additional fee of \$10.

(c) *Temporary permit fee.* Temporary permit pending examination and issuance of license for journeyman plumber, \$75. The fee shall cover the examination fee prescribed and the license fee for the year issued.

(3) **PLUMBING APPRENTICE.** A \$15 registration fee shall be paid at the time of registration and for each subsequent calendar year during which the apprentice is engaged in the plumbing apprenticeship.

(4) **MASTER PLUMBER-RESTRICTED.** The fees shall be as follows for master plumber-restricted:

(a) *Examination fee.* Master plumber-restricted examination, \$50. Each subsequent examination, \$30.

(b) *License fee.* Master plumber-restricted license, \$75 and \$75 for each renewal of license, if application is made prior to January 1, annually; after that date an additional fee of \$20.

(c) *Temporary permit fee.* Temporary permit pending examination and issuance of license for master plumber-restricted, \$200. The fee shall cover the examination fee prescribed and the license fee for the year in which issued.

(5) **JOURNEYMAN PLUMBER-RESTRICTED.** The fees shall be as follows for journeyman plumber-restricted:

(a) *Examination fee.* Journeyman plumber-restricted examination, \$30. Each subsequent examination, \$20.

(b) *License fee.* Journeyman plumber-restricted, \$30 and \$30 for each renewal of license, if application is made prior to January 1, annually; after that date an additional fee of \$10.

(c) *Temporary permit fee.* Temporary permit pending examination and issuance of license for journeyman plumber-restricted, \$75. The fee shall cover the examination fee prescribed and the license fee for the year issued.

(6) **REGISTERED LEARNER.** A \$15 fee shall be paid at the time of registration and for each subsequent calendar year during which the learner is engaged in the registered learner program.

(7) **PLUMBER LICENSE-RETIREE.** The fee for a plumber license-retiree in the categories of a master plumber, master plumber-restricted, journeyman plumber or journeyman plumber-restricted shall be equivalent to the current renewal fee for the applicable journeyman plumber license or journeyman plumber-restricted license. A plumber license-retiree shall be valid for the lifetime of the licensee.

(8) **UTILITY CONTRACTOR.** The fees for the utility contractor shall be \$75 and \$75 for each renewal of license, if application is made prior to January 1, annually; after that date an additional fee of \$20.

(9) **PIPE LAYER.** The registration fees for pipe layer shall be \$30 and \$30 for each renewal of registration, if application is made prior to January 1, annually; after that date an additional fee of \$10.

(10) **AUTOMATIC FIRE SPRINKLER CONTRACTOR.** The fees shall be as follows for automatic fire sprinkler contractor:

(a) *Examination fee.* Automatic fire sprinkler contractor examination, \$100. Each subsequent examination, \$100.

(b) *License fee.* Automatic fire sprinkler contractor license, \$500 and \$500 for each renewal of license, if application is made prior to January 1, annually; after that date an additional fee of \$25.

(c) *Temporary permit fee.* A temporary permit pending examination will be issued upon receipt of application and a fee of \$350 which covers the examination fee and the temporary permit fee. When the contractor successfully passes the examination an additional fee of \$250 shall be paid prior to the issuance of the license for the remainder of the calendar year.

(11) **JOURNEYMAN AUTOMATIC FIRE SPRINKLER FITTER.** The fees shall be as follows for journeyman automatic fire sprinkler fitter:

(a) *Examination fee.* Journeyman automatic fire sprinkler fitter examination, \$20. Each subsequent examination, \$20.

(b) *License fee.* Journeyman automatic fire sprinkler fitter license, \$30 and \$30 for each renewal of license, if application is made prior to January 1, annually; after that date an additional fee of \$10.

(c) *Temporary permit fee.* Temporary permits pending examination and issuance of license for a journeyman automatic fire sprinkler fitter, \$50. The fee shall cover the examination fee prescribed and the license fee for the calendar year issued.

(12) **AUTOMATIC FIRE SPRINKLER SYSTEM APPRENTICESHIP.** A fee of \$15 shall be paid at the time of registration and for each subsequent calendar year during which the apprenticeship is active.

(13) **AUTOMATIC FIRE SPRINKLER MAINTENANCE.** The fees shall be as follows for automatic fire sprinkler maintenance registration certificate:

(a) *Examination fee.* Automatic fire sprinkler maintenance examination, \$50. Each subsequent examination, \$30.

(b) *Registration certificate fee.* Automatic fire sprinkler maintenance registration certificate, \$100 and \$100 for each renewal of registration, if

application is made prior to January 1, annually; after that date an additional fee of \$25.

(c) *Temporary permit fee.* Temporary permit pending examination and issuance of an automatic fire sprinkler maintenance certificate, \$125 which covers the examination fee. Upon successful passage of the examination an additional \$100 shall be paid prior to the issuance of the registration certificate for the remainder of the year.

(14) **AUTOMATIC FIRE SPRINKLER FITTER MAINTENANCE.** The registration certificate fees for an automatic fire sprinkler fitter maintenance shall be \$15, and \$15 for each renewal of registration, if application is made prior to January 1, annually; after that date an additional fee of \$10.

History: Cr. Register, April, 1983, No. 328, eff. 5-1-83.

## SUBCHAPTER II — CERTIFICATION OF PLUMBING INSPECTORS

**ILHR 81.301 Purpose.** The purpose of this subchapter is to promote effective and uniform enforcement of the state uniform plumbing code for one- and 2-family dwellings, manufactured buildings for dwellings and private sewage systems. Pursuant to ch. 101, subchs. II and III, Stats., and ch. 145, Stats., this subchapter establishes the standards and procedures for certification, including suspension and revocation, of plumbing inspectors and independent plumbing inspection agencies.

History: Cr. Register, April, 1983, No. 328, eff. 5-1-83.

**ILHR 81.302 Scope.** The rules of this subchapter apply to all persons, independent inspection agencies, municipalities and state governmental agencies engaged in administering and enforcing the state uniform plumbing code for one- and 2-family dwellings, manufactured buildings for dwellings and private sewage systems, or engaged in educating, training and testing persons for state certification as a plumbing inspector.

History: Cr. Register, April, 1983, No. 328, eff. 5-1-83.

**ILHR 81.303 Saving and severable clauses.** History: Cr. Register, April, 1983, No. 328, eff. 5-1-83; r. under s. 13.93 (2m) (b) 16, Stats., Register, February, 1985, No. 350.

**ILHR 81.304 Certification processing times.** Certifications issued under this subchapter shall be granted or denied by the department within 30 business days after passage of examination or receipt of the applicable application and fees.

History: Cr. Register, February, 1985, No. 350, eff. 3-1-85.

**ILHR 81.31 Definitions.** For the purpose of this subchapter, the following terms are defined:

- (1) "Approved" means acceptable to the department.
- (2) "Certified inspection" means an inspection performed by a certified plumbing inspector.
- (3) "Certified plumbing inspector I" means an individual certified by the department to administer and enforce ch. ILHR 82.

(4) "Certified plumbing inspector II" means an individual certified by the department to administer and enforce ch. ILHR 83. Inspection responsibilities may include building sewers where no certified plumbing inspector I is available.

(5) "Certified plumbing inspector III" means an individual certified by the department to administer and enforce chs. ILHR 82 and 83.

(6) "Conflict of interest" means a certified inspector inspecting plumbing work in which the inspector or the inspector's employer or employee has participated or has a monetary or personal interest.

(7) "Department" means the department of industry, labor and human relations.

(8) "Dwelling" as defined in s. Ind 20.07 (25), means any building, the initial construction of which is commenced on or after June 1, 1980, which contains one or 2 dwelling units.

(9) "Governmental unit responsible for regulation of private sewage systems" means a county or other governmental unit as defined in s. 145.01 (15), Stats.

(10) "Gross negligence" means a high degree of failure to exercise ordinary care of judgement and failure by omission or commission to discharge the duty required to protect the health, safety and welfare of the public.

(11) "Incompetence" means conduct which evidences a lack of competence or ability to discharge the duty required to protect the health, safety and welfare of the public, lack of knowledge of the fundamental principles of plumbing inspection or an inability to apply those principles, or failure to maintain competency in the current practices and methods applicable to inspection services and the state uniform plumbing code.

(12) "Independent inspection agency" means any person, firm, association, partnership or corporation, other than a municipal corporation, certified by the department to perform certified plumbing inspections under the state uniform plumbing code.

(13) "Manufactured building", as defined in s. Ind 20.07 (52), means:

(a) Any structure or component thereof which is intended for use as a dwelling and:

1. Is of closed construction and fabricated or assembled on site or off site in manufacturing facilities for installation, connection or assembly and installation at the building site; or

2. Is a building of open construction which is made or assembled in manufacturing facilities away from the building site for installation, connection or assembly and installation on the building site and for which certification is sought by the manufacturer.

(b) The term manufactured building does not include a building of open construction which is not subject to s. Ind 20.07 (52) (a) 2. A single or double width mobile home is not considered a manufactured building.

(14) "Misconduct" means an act performed in the discharge of enforcement duties which jeopardizes the interests of the public, including violation of federal or state laws, local ordinances or administrative rules relating to the position; preparation of deficient or falsified reports; failure to submit information or reports required by law or contract when requested by the municipality or the department; conduct which evidences a lack of trustworthiness; misrepresentation of qualifications such as education, experience or certification; illegal entry of premises; misuse of funds; or misrepresentation of authority.

(15) "Municipality" means any city, village, town or county in this state.

(16) "Person" includes partnerships, associations and bodies politic or corporate.

(17) "Private sewage system" means a sewage treatment and disposal system as defined in s. 145.01 (14), Stats.

(18) "Secretary" means the secretary of the department of industry, labor and human relations.

History: Cr. Register, April, 1983, No. 328, eff. 5-1-83.

**ILHR 81.32 Administration and enforcement.** (1) **INSPECTIONS.** All inspections of one- and 2-family dwellings for the purpose of administering and enforcing the state uniform plumbing code shall be performed by certified plumbing inspectors.

(2) **PRIVATE SEWAGE SYSTEMS.** In accordance with s. 145.20, Stats., all inspections of private sewage systems of one- and 2-family dwellings shall be performed by a certified plumbing inspector II or III.

(3) **RECORDS.** Each certified plumbing inspector shall record and keep on file, in numerical order, the number of plumbing inspections made. The inspector shall record the name of the owner of the premises, the location of each inspection, and note any violation. All records and files shall be accessible to the department for inspection and review.

History: Cr. Register, April, 1983, No. 328, eff. 5-1-83.

**ILHR 81.33 Authority.** (1) **DEPARTMENTAL AUTHORITY.** Pursuant to chs. 101 and 145, Stats., the department has been granted the authority and jurisdiction over the certification, including suspension and revocation of certified inspectors or independent inspection agencies for the purpose of inspecting plumbing of one- and 2-family dwellings and manufactured buildings for dwellings.

(2) **MUNICIPALITY AUTHORITY.** Pursuant to ss. 59.065, 101.65 (1) (a), 101.66 (2), 101.76 (1) (a), 145.04 and 145.20, Stats., all municipalities exercising jurisdiction over the construction and inspection of one- and 2-family dwellings and manufactured buildings for dwellings shall provide for inspections performed by persons certified under the rules of this subchapter.

(a) Any termination of employment or disciplinary action against a certified plumbing inspector or independent inspection agency for cause directly related to the conditions of certification shall be reported to the department.

## ILHR 81

(b) Municipal termination of employment or disciplinary action shall not constitute suspension or revocation of the state certification.

(c) No certified plumbing inspector or independent inspection agency carrying a valid state certification may be required to obtain any municipal certification or license to enforce the state uniform plumbing code.

(d) 1. Certified plumbing inspectors of private sewage systems shall be employes of the respective local governmental unit responsible for the regulation of private sewage systems.

2. Inspections of private sewage systems may not be delegated to certified independent inspection agencies.

(e) Except for the regulation of private sewage systems, municipalities may jointly exercise jurisdiction, pursuant to ss. 66.30 (2), 101.65 (1) (b), 101.76 (1) (b), 145.04 and 145.13, Stats., by adopting the state uniform plumbing code and providing for inspections by certified inspectors or certified independent inspection agencies.

Note: These rules are not intended to prevent a municipality from enacting more restrictive hiring practices.

(3) INDEPENDENT INSPECTION AGENCY AUTHORITY. Pursuant to ss. 101.63 (2), 101.66 (2), 101.73 (3), (5) and (6), 101.75 (1), 101.76 (1) (a) and 145.04, Stats., certified independent inspection agencies may enter into contractual agreement with municipalities, building manufacturers or the department to provide the certified inspections required for the state uniform plumbing code.

(4) CERTIFIED INSPECTOR AUTHORITY. Pursuant to ss. 101.63 (2), 101.66 (2), 101.73 (3) and (5), 101.75 (1), 101.76 (1) (a), 145.04 and 145.20, Stats., a certified inspector may perform certified inspections in accordance with the requirements of the state uniform plumbing code.

History: Cr. Register, April, 1983, No. 328, eff. 5-1-83.

**ILHR 81.34 Inspector certification.** A person performing or offering to perform inspections for on-site dwellings or manufactured dwellings under the state uniform plumbing code shall be certified and shall satisfy the requirements of this section.

(1) APPLICATION FOR CERTIFICATION OR RECERTIFICATION. (a) All applicants shall be at least 18 years of age.

(b) Application for certification and recertification shall be made to the department together with the payment of the fee specified in s. ILHR 81.38.

(c) Applications shall be made on forms provided by the department and may be obtained by writing to:

Certification Coordinator  
Safety and Buildings Division  
Department of Industry, Labor and Human Relations  
P.O. Box 7969  
Madison, Wisconsin 53707

(d) Upon receipt of the completed application form, the department shall review and evaluate the application and make all necessary notifications to the applicant. If it is determined that the applicant does not

qualify for certification or recertification, the applicant shall be notified of the findings in writing.

(2) **REQUIREMENTS FOR CERTIFICATION OF PLUMBING INSPECTORS.** (a) Eligibility for certification shall be based upon acceptance of the application and successful completion of the approved educational training and testing programs required for the designated categories of certification and upon passage of the examination. Existing state or municipal inspectors who have the equivalent of one year of inspection experience shall be exempt from examination for initial certification.

(b) Credit shall be given for educational and training programs approved by the department.

(c) If an individual has one year of experience in plumbing inspections, the individual shall be exempt from examination but shall participate in and successfully complete the department's approved training program. A minimum of 20 units of continuing education shall be required annually.

(3) **EXAMINATION.** (a) *Application for examination.* All applications for examination shall be received by the department prior to examination. The applicant shall be advised by the department of the date and place of the examination.

(b) *Time and place of examinations.* Scheduled examinations shall be offered at least semiannually. Specific details regarding time and place are available from the department upon request.

(c) *Scope of examination.* The examination shall test the applicant's ability to inspect plumbing installations and designs to ascertain compliance with the rules of the state uniform plumbing code, and more specifically to test for:

1. Code knowledge;
2. Code administration;
3. Inspection and enforcement techniques; and

4. Skills such as, but not limited to, general mathematics, reading of plans and specifications, materials and methods of construction, construction safety and oral and written communications.

(d) *Grading of examinations.* The final grading of all examinations shall be by persons approved by the department. A grade of 75% or greater in each part shall be considered a passing grade for certification as an inspector.

(e) *Examination retake.* Applicants failing an examination, upon request and payment of the re-examination fee specified in s. ILHR 81.38, may retake the examination within one year of the original examination. All applications for re-examination shall be received by the department at least 3 weeks prior to the scheduled date of the examination to be retaken. Failure to apply for re-examination requires successful completion of approved educational courses.

(4) **RECIPROCITY.** Inspector certification may be accomplished through reciprocity provided the certification program of the state in which the inspector is certified is approved by the department.



(5) **ISSUANCE OF CERTIFICATE.** Upon completing the requirements for certification, the department shall notify the applicant in writing and shall issue an inspection certificate. The certificate shall bear the name of the applicant, certificate number and expiration date. No certificate may be valid for longer than one year and all certifications shall expire on June 30 of each year.

(6) **RENEWAL OF CERTIFICATE.** The certification of an inspector may be renewed in accordance with the requirements of sub. (1). Certification renewal shall be contingent on participation and completion of 20 units of credit annually in on-going approved education programs.

(7) **DENIAL OF CERTIFICATION.** (a) *Notice of denial.* Upon denial of certification or recertification, the department shall notify the applicant in writing stating the reasons for denial. The notice of denial shall be made by mail sent to the address filed with the application.

(b) *Hearing.* Upon receipt of denial, any applicant may submit a written request for hearing. The right to hearing shall be considered waived, if the applicant fails to submit the request within 30 days. Hearings shall be conducted by the department and the proceedings recorded.

History: Cr. Register, April, 1983, No. 328, eff. 5-1-83.

**ILHR 81.35 Independent inspection agency certification — in-plant inspections.** An independent inspection agency offering to perform in-plant plumbing inspections of manufactured dwellings and certify compliance for manufactured dwellings under the state uniform plumbing code shall be certified and shall satisfy the requirements of this section. In accordance with s. ILHR 82.25, the department shall review all plans for plumbing systems installed in factory constructed one- and 2-family dwellings.

(1) **APPLICATION FOR INDEPENDENT INSPECTION AGENCY CERTIFICATION OR RECERTIFICATION.** Application for certification and recertification shall be made to the department together with the payment of the fee specified in s. ILHR 81.38.

(a) Applications shall be made on forms provided by the department and may be obtained by writing to:

Certification Coordinator  
Safety and Buildings Division  
Department of Industry, Labor and Human Relations  
P.O. Box 7969  
Madison, Wisconsin 53707

(b) All applications for certification shall be submitted in duplicate and shall contain the following information:

1. Location of offices;
2. Names and certification numbers and qualifications of all in-plant inspectors employed by the agency;
3. A list of structures which the agency has inspected;
4. A list of states in which the agency is authorized to inspect or evaluate manufactured dwellings or components;

5. An affidavit certifying independence and absence of conflicts of interest;

6. Procedures and facilities, including record-keeping used in providing services which assure compliance with the rules of ch. ILHR 82; and

7. A list of all certified inspectors having contracts with the independent inspection agency to perform certified inspections.

(c) Any independent inspection agency to be certified by the department shall agree in writing:

1. That the department may monitor by inspection and require verification of any or all conditions specified in par. (b);

2. To make all inspection records available to the department upon request;

3. To enforce all applicable rules of ch. ILHR 82; and

4. To provide the department, upon request, with a current list of all municipalities, manufacturers or others for which it is performing certified inspections.

(d) Upon receipt of the completed application form, the department shall review and evaluate the application and make all necessary notifications to the applicant. If it is determined that the applicant does not qualify for certification or recertification, the applicant shall be notified of the findings in writing and instructed of the appeals procedure.

(2) **RECIPROCITY.** Independent inspection agency certification may be accomplished through reciprocity provided the certification program of the state in which the agency is certified is approved by the department.

(3) **ELIGIBILITY FOR CERTIFICATION.** Eligibility for certification shall be based upon acceptance of the application and the applicant's ability to perform system analysis and develop and implement a compliance assurance program.

(4) **ISSUANCE OF INDEPENDENT INSPECTION AGENCY CERTIFICATE.** Upon acceptance of the application and finding of eligibility, the department shall notify the agency in writing and shall issue an independent inspection agency certificate. The certificate shall bear the name of the independent inspection agency, certificate number and expiration date. No certificate may be valid for longer than one year and all certifications shall expire on June 30 of each year.

(5) **RENEWAL OF CERTIFICATE.** The certification of an independent inspection agency may be renewed in accordance with the requirements of sub. (1).

(6) **DENIAL OF CERTIFICATE.** (a) *Notice of denial.* Upon denial of certification or recertification, the department shall notify the applicant in writing stating the reasons for denial. The notice of denial shall be made by mail sent to the address filed with the application.

(b) *Hearing.* Upon receipt of denial, any applicant may submit a written request for hearing. The right to hearing shall be considered waived if

the applicant fails to submit the request within 30 days. Hearings shall be conducted by the department and the proceedings recorded.

History: Cr. Register, April, 1983, No. 328, eff. 5-1-83.

**ILHR 81.36 Independent inspection agency certification — on-site inspections.** An independent inspection agency offering to perform inspections for on-site dwellings under the state uniform plumbing code shall be certified and shall satisfy the requirements of this section.

(1) **APPLICATION FOR INDEPENDENT INSPECTION AGENCY CERTIFICATION.** Application for certification and recertification shall be made to the department together with the payment of the fee specified in s. ILHR 81.38.

(a) Applications shall be made on forms provided by the department and may be obtained by writing to:

Certification Coordinator  
Safety and Buildings Division  
Department of Industry, Labor and Human Relations  
P.O. Box 7969  
Madison, Wisconsin 53707

(b) All applications for certification shall be submitted in duplicate and shall contain the following information:

1. Identification of agency entity; if an individual, the full name under which the agency intends to do business shall be submitted;

2. Name, address and qualifications of all officers, directors and management personnel responsible for the administration and enforcement of the agency;

3. Location of offices of the independent inspection agency;

4. Names of certified plumbing inspectors employed by the agency;

5. An affidavit certifying independence and absence of conflicts of interest;

6. Programs, procedures and facilities, including record-keeping used in providing services which assure compliance with the rules of ch. ILHR 82; and

7. A list of all certified inspectors having contracts with independent inspection agencies to perform certified inspections.

(c) Any independent inspection agency to be certified by the department shall agree in writing:

1. That all inspections for compliance with the state uniform plumbing code shall be by certified plumbing inspectors and to make all records available to the department upon request;

2. That the department may monitor by inspection and require verification of any or all conditions specified in par. (b);

3. To enforce all applicable rules of ch. ILHR 82; and

4. To provide the department, upon request, with a current list of all municipalities, manufacturers or others for which it is performing certified inspections.

(d) Upon receipt of the completed application form, the department shall review and evaluate the application and make all necessary notifications to the applicant. If it is determined that the applicant does not qualify for certification or recertification, the applicant shall be notified of the findings in writing and instructed of the appeals procedure.

(2) **RECIPROCITY.** Independent inspection agency certification may be accomplished through reciprocity provided the certification program of the state in which the agency is certified is approved by the department.

(3) **ISSUANCE OF INDEPENDENT INSPECTION AGENCY CERTIFICATE.** Upon acceptance of the application and findings of eligibility, the department shall notify the agency in writing and shall issue an independent inspection agency certificate. The certificate shall bear the name of the independent inspection agency, certificate number and expiration date. No certificate shall be valid for longer than one year and all certifications shall expire on June 30 of each year.

(4) **RENEWAL OF CERTIFICATE.** The certification of an independent inspection agency may be renewed in accordance with the requirements of sub. (1).

(5) **DENIAL OF CERTIFICATE.** (a) *Notice of denial.* Upon denial of certification or recertification, the department shall notify the applicant in writing stating the reasons for denial. The notice of denial shall be made by mail sent to the address filed with the application.

(b) *Hearing.* Upon receipt of denial, any applicant may submit a written request for hearing. The right to the hearing shall be considered waived if the applicant fails to submit the request within 30 days. Hearings shall be conducted by the department and the proceedings recorded.

History: Cr. Register, April, 1983, No. 328, eff. 5-1-83.

**ILHR 81.37 Suspension or revocation of certification.** (1) **SUSPENSION OR REVOCATION.** The department may suspend or revoke the certification of any inspector or independent inspection agency for any of the following reasons:

(a) Fraud or deceit in obtaining certification;

(b) Knowingly aiding or abetting the unauthorized examination and inspection of dwellings by persons not certified by the department;

(c) Any gross negligence, incompetence or misconduct in the discharge of the duties required under this subchapter and the state uniform plumbing code;

(d) Conviction of a criminal charge, misdemeanor or local regulation substantially related to the circumstances of the certified inspection activity or adjudication of mental incompetence by the courts; and

(e) Conflict of interest.

(2) **FILING OF COMPLAINT.** Proceedings to revoke or suspend a certificate may be initiated by any person on a signed, written complaint filed with the department. Any alleged violation of the law or the administra-

tive rules of the department shall be set forth in the complaint with particular reference to time, place and circumstance.

(3) **INVESTIGATION AND NOTIFICATION.** The department may investigate alleged violations on its own initiative or upon the filing of a complaint. If it is determined that no further action is warranted, the department shall notify the persons affected. If the department determines that there is probable cause, it shall order a hearing and notify the persons affected.

(4) **MAILING.** Unless otherwise provided by law, all orders, notices and other papers may be served by the department by mail addressed to the party at the last known address. If the service is refused, service may be made by a sheriff without amendment of the original order, notice or other paper.

(5) **RESPONSE.** Upon receipt of notification of hearing from the department, the charged party may submit to the department a written response within 30 days of the date of service. Failure to respond within the prescribed time limit, or failure to appear at the scheduled hearing, may result in the allegations specified in the complaint being taken as true.

(6) **HEARINGS.** (a) *Subpoenas; witness fees.* Subpoenas may be signed and issued by the department or the clerk of any court of record. Witness fees and mileage of witnesses subpoenaed on behalf of the department shall be paid at the rate prescribed for witnesses in circuit court.

Note: See s. 885.05, Stats., as to the specific amounts for witness and interpreter's fees.

(b) *Conduct of hearing.* All hearings shall be conducted by persons selected by the department. Persons so designated may administer oaths or affirmations and may grant continuances and adjournments for cause shown. The respondent shall appear in person and may be represented by an attorney-at-law. Witnesses may be examined by persons designated by the department.

(7) **FINDINGS.** The department may make findings and enter its order on the basis of the facts revealed by its investigation. Any findings as a result of petition or hearing shall be in writing and shall be binding unless appealed to the secretary.

(a) *Suspension.* The period for suspension shall be determined by the hearing examiner or the secretary and may not exceed 2 years. The certification of an inspector or an independent inspection agency that has been suspended may be reinstated by filing a new application for certification and payment of the appropriate fee specified in s. ILHR 81.38.

(b) *Revocation.* The period for revocation shall be determined by the hearing examiner or the secretary and may not exceed 5 years. An inspector or independent inspection agency whose certification has been revoked may be eligible for recertification only after that time set for revocation by departmental order has passed. Certification may be reinstated only after submitting a completed application for examination, payment of the examination fee, passing of the examination and payment of the certification fee specified in s. ILHR 81.38.

(8) **APEAL ARGUMENTS.** Appeal arguments shall be submitted to the department in writing unless otherwise ordered.

History: Cr. Register, April, 1983, No. 328, eff. 5-1-83.

Register, February, 1985, No. 350

**ILHR 81.38 Certification fees.** All applicants for certification as a certified inspector or independent inspection agency shall submit, with the application form, fees in accordance with this section,

(1) **CERTIFIED INSPECTORS.** Persons applying for initial certification or recertification as a certified plumbing inspector shall submit a fee of \$25.00.

(a) *Examinations for certification.* Upon determination of eligibility for the examination for certification, fees shall be collected in accordance with the following schedule:

- 1. Initial examination..... \$25.00
- 2. Examination retakes ..... \$25.00

(b) *Educational and training seminars.* Fees shall be assessed on a per seminar basis for educational and training programs sponsored by the department.

(2) **INDEPENDENT INSPECTION AGENCIES.** Fees for the initial certification of independent inspection agencies shall be \$25.00, and for recertification, \$25.00 annually.

History: Cr. Register, April, 1983, No. 328, eff. 5-1-83.

**ILHR 81.39 Petition for rules or declaratory rulings.** Petitions for the adoption, repeal or amendment of rules and for declaratory rulings shall be in accordance with ch. 227, Stats.

History: Cr. Register, April, 1983, No. 328, eff. 5-1-83.

**ILHR 81.40 Private sewage system inspections.** All inspections of private sewage systems shall be performed by inspectors certified by the department.

(1) **CERTIFICATION.** Inspectors for private sewage systems shall be certified in accordance with the requirements of this subchapter.

(2) **LOCAL GOVERNMENTAL EMPLOYEES.** Pursuant to s. 145.20, Stats., certified plumbing inspectors of private sewage systems shall be employees of the respective local governmental unit responsible for the regulation of private sewage systems.

(3) **INDEPENDENT INSPECTION AGENCIES.** Inspections of private sewage systems may not be delegated to certified independent inspection agencies.

History: Cr. Register, April, 1983, No. 328, eff. 5-1-83.

### SUBCHAPTER III — CERTIFICATION OF SOIL TESTERS

**ILHR 81.601 Scope.** The provisions of this subchapter as authorized by s. 145.045, Stats., apply to all persons engaged in the conducting and reporting of percolation tests, other tests required by applicable rules of the state uniform plumbing code and the evaluation of bore holes or soil exposures for the purpose of determining the suitability of soils on a parcel of land for the installation of private sewage systems. The tests and soil evaluations and reporting thereof on forms supplied by the department shall apply to individual parcels on which a private sewage disposal

## ILHR 81

system is proposed for installation and to lands proposed for subdivision not served by public sewers.

History: Cr. Register, April, 1983, No. 328, eff. 5-1-83.

**ILHR 81.602 Saving and severable clauses.** History: Cr. Register, April, 1983, No. 328, eff. 5-1-83; r. under s. 13.93 (2m) (b) 16, Stats., Register, February, 1985, No. 350.

**ILHR 81.603 Certification processing times.** Certifications issued under this subchapter shall be granted or denied by the department within 30 business days after passage of examination or receipt of the applicable application and fees.

History: Cr. Register, February, 1985, No. 350, eff. 3-1-85.

**ILHR 81.61 Definitions.** For the purpose of this subchapter, the following terms are defined:

(1) "Approved" means acceptable to the department.

(2) "Department" means department of industry, labor and human relations.

(3) "Certified soil tester" means a person satisfactorily passing the examination offered to achieve certification and possessing a current certificate.

(4) "Gross negligence" means a high degree of failure to exercise ordinary care of judgement and failure by omission or commission to discharge the duty required to protect the health, safety and welfare of the public.

(5) "Incompetence" means conduct which evidences a lack of competence or ability to discharge the duty required to protect the health, safety and welfare of the public, lack of knowledge of the fundamental principles of plumbing inspection or an inability to apply those principles, or failure to maintain competency in the current practices and methods applicable to inspection services and the state uniform plumbing code.

(6) "Misconduct" means an act performed in the discharge of enforcement duties which jeopardizes the interests of the public, including violation of federal or state laws, local ordinances or administrative rules relating to the position; preparation of deficient or falsified reports; failure to submit information or reports required by law or contract when requested by the municipality or the department; conduct which evidences a lack of trustworthiness; misrepresentation of qualifications such as education, experience or certification; illegal entry of premises; misuse of funds; or misrepresentation of authority.

History: Cr. Register, April, 1983, No. 328, eff. 5-1-83.

**ILHR 81.62 Reports.** Reports for individual parcels on which a private sewage disposal system is proposed for installation shall be received by the department and the appropriate local authority on all sites investigated within 30 days of completion of testing.

History: Cr. Register, April, 1983, No. 328, eff. 5-1-83.

**ILHR 81.63 Examining committee.** (1) **CREATION.** The secretary of the department or designee shall appoint an examining committee.

Register, February, 1985, No. 350

(2) **MEMBERSHIP.** The committee shall consist of 7 members. One member shall be an employe of the department and shall serve as committee secretary. One member shall be a Wisconsin registered engineer, architect or designer; one shall be a Wisconsin registered land surveyor or sanitarian; one shall be a Wisconsin licensed plumber having experience in the installation of private sewage disposal systems; one shall be a person educated and experienced in the field of soil science; and 2 shall be public members. All members except the 2 public members shall be certified soil testers. The department shall appoint the members for terms of 3 years.

(3) **LIMITATION.** Members, other than the secretary, shall not be appointed for more than 2 successive terms.

(4) **ORGANIZATION.** The committee shall elect from its membership, not including the secretary, a chairperson and vice-chairperson. Such election shall be held at the first meeting of each calendar year.

(5) **DUTIES.** It shall be the duty of the examining committee to advise the department on a continuing basis on program considerations and on examination content relative to this subchapter.

(6) **MEETINGS.** The committee shall hold meetings as deemed necessary to fulfill its responsibilities. Meetings shall be called by the committee secretary.

History: Cr. Register, April, 1983, No. 328, eff. 5-1-83.

**ILHR 81.64 Application and examination.** (1) **APPLICATION.** Any person seeking certification as a soil tester shall be at least 18 years old and shall submit a completed application for examination on the form supplied by the department. A nonreturnable fee of \$25 shall accompany each application that is submitted to the department.

(2) **EXAMINATION.** To be eligible for certification, an applicant shall be required to pass an examination conducted by the department. Examinations shall be conducted at such frequency as the department shall decide. All applications for examination shall be received by the department at least 4 weeks prior to the date of the examination.

(3) **NOTICE OF EXAMINATION TO APPLICANTS.** Notice of the time and place of examination shall be sent by the department by first class mail to those who have completed and approved applications on file. At least 2 weeks' notice of examination shall be given to applicants. Such notice shall be mailed to the address given on the application on file and shall be presented by the applicant to gain admittance to the examination room. It shall be the applicant's responsibility to inform the department of a change in address. Failure of an applicant to receive the examination notice due to a change in address shall not be the responsibility of the department.

(4) **NONATTENDANCE AT EXAMINATION.** Failure to appear at a scheduled examination without giving prior notice to the department shall necessitate the submittal of an additional \$25 fee in order to maintain a valid examination application.

(5) **NOTICE OF EXAMINATION RESULTS.** Each person taking the examination shall receive notice of their examination grade. This notice shall be sent by the department by first class mail to the address given on the



application. The department shall keep certification examinations on file for the purpose of applicant review for no longer than 30 days after the department has mailed notification of the results of the examination.

(6) **REVIEW.** Any applicant for certification may review their examination results by appearing in person before the department. Request for review shall be in writing and received by the department within 30 days after the department has mailed notification of the results of the examination. Unless requested otherwise, examination papers may be destroyed after the 30-day review period.

(7) **APPLICATION FOR CERTIFICATE.** A person who has successfully passed a certification examination may submit an application for certificate within 60 days from the date the department has mailed the examination results. Failure to apply for a certificate within this time period shall necessitate reexamination.

History: Cr. Register, April, 1983, No. 328, eff. 5-1-83.

**ILHR 81.65 Issuance of certificate.** (1) **SCORE AND FEE.** Each person receiving an examination grade of at least 75 of a possible score of 100 shall upon receipt of the appropriate fee by the department be issued a certificate stating that they are a "Certified Soil Tester". Certificates shall expire on June 30 of each year commencing on July 1, 1983, unless duly renewed.

(2) **FEE AND ADJUSTMENTS.** The fees for certification and renewal commencing on July 1, 1983, shall be \$30. The fees may be increased by the department in \$5 increments every year after fiscal year 1983-1984 if necessary to support the program.

History: Cr. Register, April, 1983, No. 328, eff. 5-1-83.

**ILHR 81.66 Renewal of certificate; delinquency and reinstatement.** Renewal of the certificate shall be submitted by July 1 of every year commencing on July 1, 1983. Notice for the renewal of certificate and the renewal application shall be sent to all certified soil testers whose certificates were in force during the previous applicable certification period. Such notice and application shall be sent by the department by first class mail to the address given on the latest renewal application on file unless written notice of another address has been given. Failure to receive the notice for renewal of certificate may not be an excuse for failure to renew. If the renewal application and appropriate fee under s. ILHR 81.65 (2) are not postmarked by July 1, the certificate shall be revoked automatically. Within 12 months after revocation, the department may reinstate a revoked certificate upon receipt of a completed certification renewal application and payment of the appropriate renewal fee under s. ILHR 81.65 (2), plus a late filing fee of \$10. A certificate which has lapsed for a period of more than 12 months shall be reinstated by the department only after filing a new application, payment of \$25 examination fee, passing an examination and payment of the appropriate certification fee.

History: Cr. Register, April, 1983, No. 328, eff. 5-1-83.

**ILHR 81.67 Revocation or suspension of certificate.** (1) **GENERAL.** The department may conduct an investigation of any alleged violation of the state uniform plumbing code. In accordance with s. 145.045 (2), Stats., the department may revoke or suspend the certificate of any soil tester after a formal hearing under ch. 227, Stats., for the practice of any fraud

Register, February, 1985, No. 350

or deceit in obtaining the certificate or any gross negligence, incompetence or misconduct related to soil testing.

(2) **SUSPENSION.** The period for suspension shall be determined by the department and may not exceed 2 years. A person whose certificate has been suspended may have the certificate reinstated by filing a new application for certification and payment of the appropriate fee specified in s. ILHR 81.66.

(3) **REVOCATION.** The period for revocation shall be determined by the department and may not exceed 5 years. A person whose certificate has been revoked shall be eligible for recertification only after the time set for revocation by departmental order has passed. A person whose certificate has been revoked shall have the certification reinstated only after submitting a completed application for examination, payment of the examination fee, passing of the examination and payment of the certification fee specified in ss. ILHR 81.64 and 81.65.

History: Cr. Register, April, 1983, No. 328, eff. 5-1-83.



Chapter ILHR 82

DESIGN, CONSTRUCTION, INSTALLATION  
SUPERVISION AND INSPECTION OF PLUMBING

ILHR 82.01	Scope (p. 39)	ILHR 82.34	Interceptors and catch basins for special and industrial wastes (p.96 )
ILHR 82.03	Application (p. 39)	ILHR 82.35	Cleanouts (p. 106)
	<b>SUBCHAPTER I</b>	ILHR 82.36	Storm and clear water drain systems (p. 110)
	Plumbing Principles and Definitions		<b>SUBCHAPTER IV</b>
ILHR 82.10	Basic plumbing principles (p. 39)		Water Supply Systems
ILHR 82.11	Definitions (p. 41)	ILHR 82.40	Water service and water distribution systems (p. 117)
	<b>SUBCHAPTER II</b>	ILHR 82.41	Back-siphonage, cross-connections and potability control (p. 142)
	Administration and Enforcement		<b>SUBCHAPTER V</b>
ILHR 82.20	Plan review and approval (p. 53)		Special Plumbing Installations
ILHR 82.21	Testing and maintenance (p. 57)	ILHR 82.50	Health care related facilities (p. 147)
	<b>SUBCHAPTER III</b>	ILHR 82.51	Mobile home sites and parks (p. 159)
	Drain and Vent Systems		<b>SUBCHAPTER VI</b>
ILHR 82.30	Sanitary drain systems (p. 61)		Installation
ILHR 82.31	Vents and venting systems (p. 76)	ILHR 82.60	Pipe hangers and supports (p. 160)
ILHR 82.32	Traps and direct fixture connections (p. 89)		
ILHR 82.33	Indirect and local waste piping (p. 91)		

Note: Sections ILHR 82.01 to 82.12, 82.15 and 82.17 to 25 as they existed on February 28, 1985 were repealed and new sections ILHR 82.01 to 82.36 and 82.51 and 82.60 were created effective March 1, 1985.

**ILHR 82.01 Scope.** The provisions of this chapter apply to the design, construction and installation of plumbing, including but not limited to sanitary and storm drainage, water supplies, storm water and sewage disposal for buildings.

Note: Chapter ILHR 83 contains provisions for the siting, design, installation, inspection and maintenance of private sewage systems. Chapter ILHR 84 contains provisions and standards for plumbing materials, plumbing fixtures and plumbing appliances.

History: Cr. Register, February, 1985, No. 350, eff. 3-1-85.

**ILHR 82.03 Application.** The provisions of this chapter are not retroactive, unless specifically stated otherwise in the rule.

History: Cr. Register, February, 1985, No. 350, eff. 3-1-85.

**Subchapter I**  
**Plumbing Principles and Definitions**

**ILHR 82.10 Basic plumbing principles.** This chapter is founded upon certain basic principles of environmental sanitation and safety through properly designed, installed, and maintained plumbing systems. Some of the details of plumbing construction may vary, but the basic sanitary and safety principles desirable and necessary to protect the health of people are the same everywhere. As interpretations may be required, and as unforeseen situations arise which are not specifically addressed, the following principles shall be used to define the intent of this chapter.

- (1) Plumbing in all buildings, public and private, intended for human occupancy, shall be installed and maintained in such a manner so as to protect the health, safety and welfare of the public or occupants.
- (2) Every building intended for human occupancy shall be provided with an adequate, safe and potable water supply. A potable water supply shall not be connected to an unsafe water supply or a drain pipe, nor shall it be subject to the hazards of backflow or back siphonage. A building located adjacent to a street in which there is a public water supply, shall be connected to the public water supply by means of individual connections or private mains.
- (3) In accordance with chs. Ind 20 to 25, each dwelling unit connected to a private sewage system or public sewer shall have at least one water closet, one wash basin, one kitchen sink and one bathtub or shower to meet the basic requirements of sanitation and personal hygiene. All other structures for human occupancy shall be equipped with sanitary facilities in sufficient numbers as specified in chs. ILHR 50 to 64.
- (4) Plumbing fixtures, appliances and appurtenances, whether existing or to be installed, shall be supplied with water in sufficient volume and at pressures adequate to enable them to function properly and efficiently at all times and without undue noise under normal conditions of use. Plumbing systems shall be designed and adjusted to use the minimum quantity of water consistent with proper performance and cleaning.
- (5) Hot or tempered water shall be supplied to all plumbing fixtures which normally require hot or tempered water for proper use and function.
- (6) Devices for heating water and storing it in pressure vessels or tanks shall be so designed and installed as to prevent dangers of explosion or overheating.
- (7) Every building with installed plumbing fixtures and intended for human occupancy, located adjacent to a street in which there is public sewer service, shall be connected to the public sewer by means of individual connections or private interceptor mains.
- (8) Where plumbing fixtures exist in a building which is not connected to a public sewer system, suitable provision shall be made for disposing of the building sewage by a method of sewage treatment or disposal satisfactory to the department and the governmental unit responsible for the regulation of private sewage systems.
- (9) Drain systems shall be designed, constructed, and maintained to conduct the waste water or sewage quickly from the fixture to the place of disposal, with velocities which will prevent clogging, fouling and the depositing of solids, and shall have adequate cleanouts so arranged that the drain pipes may be readily cleaned.
- (10) The drain systems shall be designed so that there is an adequate circulation of air in all pipes and no danger of siphonage, aspiration or forcing of trap seals under conditions of ordinary use.
- (11) The piping of a plumbing system shall be of durable material, free from defective workmanship, and designed and constructed to give satisfactory service for its reasonable expected life.

(12) Plumbing fixtures shall be made of durable, smooth, nonabsorbent and corrosion resistant material, and shall be free from concealed fouling surfaces.

(13) Proper protection shall be provided to prevent contamination of food, water, sterile goods and similar materials by backflow of sewage.

(14) All plumbing fixtures shall be installed to provide adequate spacing and accessibility for the intended use and for cleaning.

(15) All rooms in which water closets, urinals or similar fixtures are installed shall be provided with adequate lighting and proper ventilation.

Note: See ss. ILHR 52.53 to 52.55 for toilet rooms located in commercial and public buildings.

History: Cr. Register, February, 1985, No. 350, eff. 3-1-85.

**ILHR 82.11 Definitions. In chs. ILHR 82 and 84:**

(1) "Accepted engineering practice" means a specification, standard, guideline or procedure in the field of construction or related thereto, generally recognized and accepted as authoritative.

(2) "Accessible" when applied to a fixture, appliance, pipe, fitting, valve or equipment, means having access thereto, but which first may require the removal of an access panel or similar obstruction.

(3) "Air-break" means a piping arrangement for a drain system where the wastes from a fixture, appliance, appurtenance or device discharge by means of indirect or local waste piping terminating in a receptor at a point below the flood level rim of the receptor and above the inlet of the trap serving the receptor.

(4) "Air-gap, drain system" means the unobstructed vertical distance through free atmosphere between the outlet of indirect or local waste piping and the flood level rim of the receptor into which it discharges.

(5) "Air-gap, water supply system" means the unobstructed vertical distance through the free atmosphere between the lowest opening from any pipe or faucet supplying water to a tank, vat, plumbing fixture or other device and the flood level rim of the fixture, device or receptor.

(6) "Alignment" means installed in a straight line, either horizontal, vertical or at a given angle.

(7) "Anti-siphon" means a term applied to valves or mechanical devices which eliminate siphonage.

(8) "Anti-siphon ballcock" means an anti-siphon device in the form of an approved air gap or vacuum breaker which is an integral part of the ballcock unit and which is positioned on the discharge side of the water supply control valve.

(9) "Approved" means acceptable to the department.

(10) "Area drain" means a receptor designed to collect surface or storm waters from an open area.

(11) "Areawide water quality management plan" means those plans prepared by the department of natural resources, including those plans

prepared by agencies designated by the governor under the authority of ss. 144.025 (1) and (2), and 147.25, Stats., for the purpose of managing, protecting and enhancing groundwater and surface water of the state.

Note: See Appendix for further explanatory material.

(12) "Aspirator" means a fitting or device supplied with water or other fluid under positive pressure which passes through an integral orifice or constriction causing a vacuum.

(13) "Autopsy table" means a fixture or table used for post-mortem examination.

(14) "Backflow" means the unwanted reverse flow of liquids in a piping system.

(15) "Backflow connection" means any arrangement whereby backflow can occur.

(16) "Back-pressure" means a pressure higher than the water supply pressure which may cause backflow.

(17) "Backflow preventer" means a device or means to prevent backflow.

(18) "Back-siphonage" means backflow caused by the formation of a vacuum or partial vacuum in a water supply pipe.

(19) "Backwater valve" means a device designed to prevent the reverse flow of storm water or sewage into the drain system.

Note: Back vent, see "individual vent".

(20) "Ballcock" means a water supply valve opened or closed by means of a float or similar device used to supply water to a tank.

(21) "Bathroom group" means a water closet, lavatory and a bathtub or shower located together on the same floor level.

(22) "Battery of fixtures" means any group of 2 or more fixtures which discharge into the same horizontal branch drain.

(23) "Bedpan sterilizer" means a fixture used for sterilizing bedpans or urinals by direct application of steam, boiling water or chemicals.

(24) "Bedpan washer and sanitizer" means a fixture designed to wash bedpans and to flush the contents into the sanitary drain system and which may also provide for disinfecting utensils by scalding with steam or hot water.

(25) "Bedpan washer hose" means a device supplied with hot or cold water, or both, and located adjacent to a water closet or clinical sink to be used for cleansing bedpans.

(26) "Bell" means the portion of a pipe which is enlarged to receive the end of another pipe of the same diameter for the purpose of making a joint.

(27) "Boiler blow-off basin" means a vessel designed to receive the discharge from a boiler blow-off outlet and to cool the discharge to a temperature which permits safe entry into the drain system.

(28) "Branch" means a part of a piping system other than a riser, main or stack.

(29) "Branch interval" means the vertical distance along a drain stack measured from immediately below a branch drain connection to immediately below the first lower branch drain connection which is 8 feet or more below.

Note: See Appendix for further explanatory material.

(30) "Branch vent" means a vent serving more than one fixture drain.

(31) "B.T.U." means British Thermal Units.

(32) "Building" means a structure for support, shelter or enclosure of persons or property.

(33) "Building, public" means any structure, including exterior parts of such building, such as a porch, exterior platform or steps providing means of ingress or egress, used in whole or in part as a place of resort, assemblage, lodging, trade, traffic, occupancy or use by the public, or by 3 or more tenants.

(34) "Building drain" means horizontal piping within or under a building, installed below the lowest fixture or the lowest floor level from which fixtures can drain by gravity to the building sewer.

(35) "Building drain branch" means a fixture drain which is individually connected to a building drain and is vented by means of a combination drain and vent system.

(36) "Building drain, sanitary" means a building drain which conveys sewage only.

(37) "Building drain, storm" means a building drain which conveys storm water wastes or clear water wastes, or both.

(38) "Building sewer" means that part of the drain system not within or under a building which conveys its discharge to a public sewer, private interceptor main sewer, private sewage system or other point of disposal.

(39) "Building sewer, sanitary" means a building sewer which conveys sewage only.

(40) "Building sewer, storm" means a building sewer which conveys storm water wastes or clear water wastes, or both.

(41) "Building subdrain" means the horizontal portion of a drain system which does not flow by gravity to the building sewer.

(42) "Burr" means a roughness or metal protruding from the walls of a pipe usually as the result of cutting the pipe.

(43) "Bypass" means an installation of control valves and piping so installed as to isolate or go around a specific fixture, appliance, equipment or area of piping.

(44) "Catch basin" means a watertight receptacle built to arrest sediment of surface, subsoil or other waste drainage, and to retain oily or greasy wastes, so as to prevent their entrance into the building drain or building sewer.



(45) "Circuit vent" means a branch vent that serves 2 or more fixture traps which discharge to a horizontal branch drain and connects to the horizontal drain at a point between the 2 most upstream, floor outlet fixtures.

(46) "Cleanout" means an accessible opening in a drain system used for the removal of obstructions.

(47) "Clear water wastes" means liquids other than storm water, having no impurities or where impurities are below a minimum concentration considered harmful by the department, including, but not limited to noncontact cooling water and condensate drainage from refrigeration compressors and air conditioning equipment, drainage of water used for equipment chilling purposes and cooled condensate from steam heating systems or other equipment.

(48) "Combination fixture" means a fixture combining one sink and laundry tray or a 2 or 3 compartment sink or laundry tray in one unit.

(49) "Combination drain and vent system" means a specially designed system of drain piping embodying the wet venting of one or more fixtures by means of a common drain and vent pipe adequately sized to provide free movement of air in the piping.

(50) "Common vent" means a branch vent connecting at or downstream from the junction of 2 fixture drains and serving as a vent for those fixture drains.

(51) "Conductor" means a drain pipe inside the building which conveys storm water from a roof to a leader, storm drain or storm sewer.

(52) "Contamination" means a general term meaning the introduction into the potable water supply of chemicals, wastes or sewage which will render the water unfit for its intended purpose.

(53) "Corporation cock" means a valve installed in the side of a water main to which a water service pipe is connected or a valve installed in the side of a forced main sewer to which a forced building sewer is connected.

(54) "Critical level" means the reference point on a vacuum breaker which must be submerged before backflow can occur. When the critical level is not indicated on the vacuum breaker, the bottom of the vacuum breaker shall be considered the critical level.

(55) "Cross-connection" means a physical connection or arrangement between two otherwise separate piping systems, one of which contains potable water and the other either water of unknown or questionable safety, steam, gas or chemicals whereby there may be a flow from one system to the other, the direction of flow depending on the pressure differential between the two systems.

(56) "Curb stop" means a valve placed in a water service pipe.

(57) "Dead end" means a branch leading from a drain pipe, vent pipe, building drain or building sewer and terminating at a developed length of 2 feet or more by means of a plug, cap or other closed fitting.

(58) "Department" means the department of industry, labor and human relations.

(59) "Developed length" means the length of pipe line measured along the center line of the pipe and fittings.

(60) "Diameter" means in reference to a pipe the nominal inside diameter of the pipe.

Note: Downspout, see "leader".

(61) "Drain" means any pipe which carries waste water or water borne wastes.

(62) "Drain system" includes all the piping or any portion of the piping within public or private premises which conveys sewage, storm water or other liquid wastes to a legal point of disposal, but does not include the mains of public sewer systems or a private or public sewage treatment or disposal plant.

(63) "Dwelling unit" means a structure, or that part of a structure, which is used or intended to be used as a home, residence or sleeping place by one person or by 2 or more persons maintaining a common household, to the exclusion of all others.

(64) "Ejector" means an automatically operated device to elevate liquid wastes and sewage by the use of air under higher than atmospheric pressure.

(65) "Faucet" means a valve end of a water pipe by means of which water can be drawn from or held within the pipe.

(66) "Ferrule" means a rigid sleeve used to connect dissimilar plumbing materials.

(67) "Fixture drain" means the drain from fixture to a junction with another drain pipe.

(68) "Fixture supply connections" means that part of the piping system within 18 inches from the fixture supply branch to the fixture.

(69) "Fixture unit, drainage, dfu" means a measure of the probable discharge into the drain system by various types of plumbing fixtures. The drainage fixture unit value for a particular fixture depends on its volume rate of drainage discharge, on the time duration of a single drainage operation, and on the average time between successive operations.

(70) "Fixture unit, supply, sfu" means a measure of the probable hydraulic demand on the water supply by various types of plumbing fixtures. The supply fixture unit value for a particular fixture depends on its volume rate of supply, on the time duration of a single supply operation, and on the average time between successive operations.

(71) "Flexible joint" means any joint between two pipes that permits one of the pipes to be deflected or moved without disturbing the other pipe.

(72) "Flood level rim" means the edge of the receptacle from which water overflows.

(73) "Floor sink" means a receptor for the discharge from indirect or local waste piping installed with its flood level rim even with the surrounding floor.

(74) "Flow pressure" means the pressure in the water supply pipe near the faucet or water outlet while the faucet or water outlet is wide open and flowing.

(75) "Flush valve" means a device located at the bottom of a tank for flushing water closets and similar fixtures.

(76) "Flushometer valve" means a device which discharges a predetermined quantity of water to fixtures for flushing purposes and is closed by direct water pressure.

(77) "Garage, private" means a building or part of a building used for the storage of vehicles or other purposes, by a family or less than 3 persons not of the same family and which is not available for public use.

(78) "Garage, public" means a building or part of a building which accommodates or houses self-propelled land, air or water vehicles for 3 or more persons not of the same family.

(79) "Grease interceptor" means a receptacle designed to intercept and retain grease or fatty substances.

(80) "Health care facility" means any building or part of a building used for purposes such as hospitals, nursing or rest homes, homes for the aged, infirmaries, residential care facilities, sanitariums, mortuaries, medical laboratories, and offices and clinics with operatories for dentists and doctors.

(81) "Horizontal pipe" means any pipe or fitting which makes an angle of less than 45° with the horizontal.

(82) "Hot water" means water at a temperature of 110° F. or more.

(83) "Hot water storage tank" means a tank used to store water that is heated indirectly by a circulating water heater or by steam or hot water circulating through coils or by other heat exchange methods internal or external to the tank.

(84) "Hydrostatic test" means a test performed on a plumbing system or portion thereof in which the system is filled with a liquid, normally water, and raised to a designated pressure.

(85) "Indirect waste piping" means drain piping which does not connect directly with the drain system, but which discharges into the drain system by means of an air break or air gap into a receptor.

(86) "Individual vent" means a pipe installed to vent a fixture trap.

(87) "Industrial wastes" means the liquid wastes which result from the processes employed in industrial establishments and which are free from fecal matter.

(88) "Interceptor" or "separator" means a device designed and installed so as to separate and retain deleterious, hazardous or undesirable matter from wastes flowing through it.

(89) "Journeyman plumber" means a person as defined in s. 145.01 (3), Stats.

(90) "Leader" means a pipe or channel outside a building which conveys storm water from the roof or gutter drains to a storm drain, storm sewer or to grade.

(91) "Load factor" means the percentage of the total connected fixture unit flow rate which is likely to occur at any point in the drain system.

(92) "Local waste piping" means a portion of drain piping which receives the wastes discharged from indirect waste piping and which discharges those wastes by means of an air break or air gap into a receptor.

(93) "Local vent" means a pipe connecting to a fixture and extending to outside air through which vapor or foul air is removed from the fixture.

(94) "Main" means the principal pipe artery to which branches may be connected.

(95) "Manhole" means an opening constructed to permit access to a sewer or any underground portion of a plumbing system.

(96) "Master plumber" means a person as defined in s. 145.01 (2), Stats.

(97) "Mechanical joint" means a connection between pipes, fittings or pipes and fittings by means of a device, coupling, fitting or adapter where compression is applied around the center line of the pieces being joined, but which is neither caulked, threaded, soldered, solvent cemented, brazed nor welded.

(98) "Mobile home" means a vehicle as defined in s. 101.91, Stats.

(99) "Mobile home drain connector" means the pipe which joins the drain piping for a mobile or manufactured home to the building sewer.

(100) "Mobile home park" means any plot or plots of ground as defined in s. 66.058, Stats.

(101) "Multiple dwelling" means a building containing more than 2 dwelling units.

(102) "Nonpotable water" means water not safe for drinking, personal or culinary use.

(103) "Nonpublic" means, in the classification of plumbing fixtures, those fixtures in residences, apartments, living units of hotels and motels, and other places where the fixtures are intended for the use by a family or an individual to the exclusion of all others.

(104) "Nuisance" means any source of filth or probable cause of sickness pursuant to the provisions of s. 146.14, Stats.

(105) "Oil interceptor" means a device designed to intercept and retain oil, lubricating grease or other similar materials.

(106) "Offset" means a combination of fittings or bends which brings one section of the pipe out of line but into a line parallel with the other section.

(107) "One or 2-family dwelling" means a building containing not more than 2 dwelling units.

(108) "Open air" means outside the building.

(109) "Pitch" means the gradient or slope of a line of pipe in reference to a horizontal plane.

(110) "Place of employment" means a place as defined in s. 101.01 (2) (a), Stats.

(111) "Plumbing" means piping, fixtures, appliances, appurtenances, devices and systems as defined in s. 145.01 (1), Stats.

(112) "Plumbing appliance" means any one of a special class of plumbing devices which is intended to perform a special function. The operation or control of the appliance may be dependent upon one or more energized components, such as motors, controls, heating elements, or pressure or temperature sensing elements. The devices may be manually adjusted or controlled by the user or operator, or may operate automatically through one or more of the following actions: a time cycle, a temperature range, a pressure range, a measured volume or weight.

(113) "Plumbing appurtenance" means a manufactured device or pre-fabricated assembly of component parts which is an adjunct to the basic piping system and plumbing fixtures. An appurtenance does not demand additional water supply, nor does it add any discharge load to a fixture or the drain system. It is presumed that the appurtenance performs some useful function in the operation, maintenance, servicing, economy, or safety of the plumbing system.

(114) "Plumbing fixture" means a receptacle or device which:

(a) Is either permanently or temporarily connected to the water distribution system of the premises, and demands a supply of water from the system;

(b) Discharges used water, waste materials, or sewage either directly or indirectly to the drain system of the premises; or

(c) Requires both a water supply connection and a discharge to the drain system of the premises.

(115) "Plumbing system" includes all water supply, water services and water distribution piping, plumbing fixtures and traps; drain and vent pipes; building drains, building sewers and private domestic sewage disposal systems including the respective connections, equipment, devices, appliances and appurtenances within the property line of the premises; and water-treating or water-using equipment in connection with the water and drain systems and the installation thereof.

(116) "Potable water" means water which is:

(a) Safe for drinking, personal or culinary use; and

(b) Free from impurities present in amounts sufficient to cause disease or harmful physiological effects and conforming in its bacteriological and chemical quality to the requirements specified in ch. NR 109.

(117) "Pressure relief valve" means a pressure actuated valve held closed by a spring or other means and designed to automatically relieve pressure at a designated pressure.

(118) "Private interceptor main sewer" means a privately owned sewer serving 2 or more buildings and not directly controlled by a public authority.

(119) "Private water main" means a privately owned water main serving 2 or more buildings and not directly controlled by a public authority.

(120) "Process piping" means piping which is separated from the water distribution or drain system by approved methods or means and used exclusively for refining, manufacturing, industrial or shipping purposes of every character and description.

(121) "Public" means, in the classification of plumbing fixtures, those fixtures which are available for use by the public or employees.

(122) "Public sewer" means a sewer owned and controlled by a public authority.

(123) "Public water main" means a water supply pipe for public use owned and controlled by a public authority.

(124) "Quick closing valve" means a valve or faucet that closes automatically when released manually or controlled by mechanical means for fast action closing.

(125) "Receptor" means a fixture or device which receives the discharge from indirect or local waste piping.

(126) "Reduced pressure principle type backflow preventer" means a device consisting of two independently acting check valves, spring loaded to a closed position and separated by an intermediate chamber in which there is an automatic relief vented to atmosphere, spring loaded to the open position.

(127) "Relief vent" means a vent which permits additional circulation of air in or between drain and vent systems.

(128) "Riser" means a water supply pipe which extends vertically one full story or more.

(129) "Roof drain" means a drain installed to receive water collecting on the surface of a roof and to discharge it into a conductor.

(130) "Roughing in" means the installation of all parts of the plumbing system which can be completed prior to the installation of fixtures including drain, water supply and vent piping and the necessary fixture supports.

(131) "Row house" means a place of abode not more than 3 stories in height, arranged to accommodate 3 or more attached row living units in which each living unit is separated from the adjoining unit by a vertical occupancy separation of not less than one-hour fire-resistive construction, extending from the basement or lowest floor to the under side of the roof deck.

(132) "Safing" means a pan or other collector placed beneath a pipe or fixture to prevent leakage from escaping to the floor, ceiling or walls.

(133) "Sand interceptor" means a receptacle designed to intercept and retain sand, grit, earth and other similar solids.

(134) "Sanitary sewer" means a pipe which carries sewage excluding storm water, surface water, ground water and clear water wastes.

(135) "Sewage" means any liquid waste containing animal or vegetable matter in suspension or solution, and may include liquids containing chemicals in solution.

(136) "Sewage grinder pump" means a type of sewage pump which macerates sewage.

(137) "Sewage pump" means an automatic pump for the removal of sewage from a sanitary sump.

(138) "Slip-joint" means a connection in which one pipe slips into another, the joint of which is made tight with a compression type fitting.

(139) "Spigot" means the end of a pipe which fits into a bell or hub.

(140) "Spring line, pipe" means the line or place from which the arch of a pipe or conduit rises.

Note: See Appendix for further explanatory material.

(141) "Stack" means a drain or vent pipe which extends vertically one full story or more.

(142) "Stack vent" means a vent extending from the top of a drain stack.

(143) "Standpipe" means a drain pipe serving as a receptor for the discharge wastes from indirect or local waste piping.

(144) "Sterilizer, boiling type" means a device of nonpressure type, used for boiling instruments, utensils, or other equipment for disinfection.

(145) "Sterilizer, instrument" means a device for the sterilization of various instruments.

(146) "Sterilizer, pressure instrument washer" means a pressure vessel designed to both wash and sterilize instruments during the operating cycle of the device.

(147) "Sterilizer, pressure" means a pressure vessel fixture designed to use steam under pressure for sterilizing.

Note: A pressure sterilizer is also referred to as an autoclave.

(148) "Sterilizer, utensil" means a device for the sterilization of utensils.

(149) "Sterilizer vent" means a separate pipe or stack, indirectly connected to the drain system at the lower terminal, which receives the vapors from nonpressure sterilizers, or the exhaust vapors from pressure sterilizers, and conducts the vapors directly to the outer air.

(150) "Sterilizer, water" means a device for sterilizing water and storing sterile water.

(151) "Storm sewer" means a pipe which carries storm water, surface water, ground water and clear water wastes.

(152) "Subsoil drain" means that part of a drain system which conveys the ground or seepage water from the footings of walls or below the basement floor under buildings to the storm sewer or other point of disposal.

(153) "Sump" means a tank or pit which receives sewage or liquid wastes, usually located below the normal grade of the gravity system and which must be emptied by mechanical means.

(154) "Sump pump" means an automatic water pump for the removal of drainage, other than raw sewage, from a sump, pit or low point.

(155) "Sump vent" means a vent pipe from a nonpressurized sump.

(156) "Supports" means hangers, anchors and other devices for supporting and securing pipes, or fixtures to structural members of a building.

(157) "Swimming pool" means a structure, basin, chamber or tank containing an artificial body of water for swimming, diving or recreational bathing having a depth of 2 feet or more at any point.

(158) "Temperature and pressure relief valve" means a combination relief valve designed to function as both a temperature relief and pressure relief valve.

(159) "Temperature relief valve" means a temperature actuated valve designed to automatically discharge at a designated temperature.

(160) "Trap" means a fitting, device or arrangement of piping so designed and constructed as to provide, when properly vented, a liquid seal which prevents emission of sewer gases without materially affecting the flow of sewage or waste through it.

(161) "Trap seal" means the vertical distance between the top of the trap weir and the top of the dip separating the inlet and outlet of the trap.

(162) "Trap weir" means that part of a trap which forms a dam over which wastes must flow to enter the drain piping.

(163) "Turf sprinkler system" means a system of piping, appurtenances and devices so installed as to distribute water for lawn or other similar irrigation purposes.

(164) "Vacuum" means any pressure less than that exerted by the atmosphere.

(165) "Vacuum breaker" means an atmospheric device installed and designed to protect a water supply against back-siphonage by allowing the entry of air to relieve vacuums in the water distribution systems.

(166) "Vacuum relief valve" means a device which admits air into the water distribution system to prevent excessive vacuum in a water storage tank or heater.

(167) "Vent" means a part of the plumbing system used to equalize pressures and ventilate the system.

(168) "Vent header" means a branch vent which connects 2 or more stack vents or vent stacks or both and extends to the outside air.



(169) "Vent stack" means a vertical vent pipe which extends one or more stories.

(170) "Vent system" means a pipe or pipes installed to provide a flow of air to or from a drain system, or to provide a circulation of air within the system to protect trap seals from siphonage and back pressure.

(171) "Vertical pipe" means any pipe or fitting which makes an angle of 45 degrees or less with the vertical.

(172) "Wall mounted water closet" means a water closet attached to a wall in such a way that it does not touch the floor.

(173) "Waste" means the discharge from any fixture, appliance, area or appurtenance.

(174) "Waste sink" means a receptor for the discharge from indirect or local waste piping installed with its flood level rim above the surrounding floor.

(175) "Water closet" means a water flushed plumbing fixture designed to receive human excrement directly from the user of the fixture.

(176) "Water conditioner" means an appliance, appurtenance or device used for the purpose of ion exchange, demineralizing water or other methods of water treatment.

(177) "Water distribution branch" means a part of the water distribution piping system other than a main, riser or branch main to within 18 inches of one or more fixtures.

(178) "Water distribution branch main" means a water distribution pipe to convey water to a riser, a pipe serving 2 or more branches with or without other branch mains.

(179) "Water distribution main" means the principal water distribution pipe to which risers, branch mains or branches are connected.

(180) "Water distribution riser" means a water distribution pipe which extends vertically one full story or more to convey water to mains, branch mains, branches or a group of fixtures.

(181) "Water distribution system" means piping which conveys water from the service to the plumbing fixtures, appliances, appurtenances, equipment, devices or other systems served including fittings and control valves.

(182) "Water heater" means any heating device with piping connections to the potable water supply system which is intended to supply hot water for domestic or commercial purposes other than space heating.

(183) "Water service" means the pipe from the water main or other source of potable water supply to a point for connection with a water distribution system or other system to be served.

(184) "Water supply system" means the water service pipe, water distribution pipes and necessary connecting pipes, fittings, control valves and all appurtenances in or adjacent to the building or premises.

(185) "Wet vent" means that portion of a vent pipe which receives the discharge of wastes from other than water closets, urinals or other fixtures which discharge like sewage or fecal matter.

(186) "Yoke vent" means a vent connected to a drain stack for the purpose of preventing pressure changes in the drain stack.

History: Cr. Register, February, 1985, No. 350, eff. 3-1-85.

**Subchapter II**  
**Administration & Enforcement**

**ILHR 82.20 Plan review and approval.** (1) **GENERAL.** Plumbing plans and specifications shall be submitted to the department or to an approved agent municipality for review in accordance with pars. (a) and (b). Prior to July 1, 1985, the department shall review and make a determination on an application for plan review within 20 business days of receiving the required information and fees. Beginning on July 1, 1985, and thereafter, the department shall review and make a determination on an application for plan review within 15 business days of receiving the required information and fees.

(a) *Department review.* Plumbing plans and specifications for the types of plumbing installations listed in Table 82.20-1 shall be submitted to the department for review, regardless of where the installation is to be located. Written approval for the plumbing plans shall be obtained prior to installation of the plumbing.

**Table 82.20-1**  
**SUBMITTALS TO DEPARTMENT**

Type of Plumbing Installation
1. All plumbing, new installations, additions and alterations, regardless of the number of plumbing fixtures involved, to be installed in health care facilities.
2. Plumbing, new installations, additions and alterations involving 6 or more plumbing fixtures, to be installed in buildings owned by a metropolitan or sanitary sewer district. <sup>a</sup>
3. Plumbing, new installations, additions and alterations involving 6 or more plumbing fixtures, to be installed in buildings owned by the state. <sup>a</sup>
4. Engineered plumbing systems.
5. Controlled roof drainage systems.
6. Reduced pressure zone principle backflow preventers.

Note a: A water heater is to be counted as a plumbing fixture.

(b) *Department or agent municipality review.* Plumbing plans and specifications for the types of plumbing installations listed in Table 82.20-2 shall be submitted for review to an agent municipality, if the installation is to be located within the agent municipality or to the department, if the installation is not to be located within an agent municipality. A municipality shall be designated as an agent municipality in accordance with sub. (2). Written approval for the plumbing plans shall be obtained prior to installation of the plumbing.

**Table 82.20-2**  
**SUBMITTALS TO DEPARTMENT OR AGENT MUNICIPALITY**

Type of Plumbing Installation
1. New installations, additions and alterations to drain systems, vent systems, water service systems, and water distribution systems involving 6 or more plumbing fixtures to be installed in public buildings. <sup>a,b</sup>
2. Grease interceptors to be installed for public buildings.
3. Garage catch basins and oil interceptors to be installed for public buildings.
4. Car wash interceptors.
5. Sanitary dump stations.
6. Turf sprinkler systems connected to a potable water system.
7. Private water mains.
8. Water supply systems and drain systems to be installed for mobile home parks. <sup>c</sup>
9. Private interceptor main sewers. <sup>c</sup>
10. Chemical waste systems regardless of the number of plumbing fixtures involved. <sup>c</sup>

Note a: A water heater is to be counted as a plumbing fixture.

Note b: For the purpose of plan submittal, public buildings do not include zero-lot-line row houses where each living unit is served by an individual water service and an individual building sewer.

Note c: Only agent municipalities which are cities of the first class may review these types of installations.

1. Plan review and approval of one- and 2-family dwellings. Review and approval of plumbing plans for one- and 2-family dwellings shall be in accordance with the provisions specified in s. Ind. 20.09.

2. Local review. An agent municipality may require by local ordinance the submittal and review of plumbing plans for those installations involving 5 or less plumbing fixtures.

(2) AGENT MUNICIPALITIES. The department may designate to an approved municipality the authority to review and approve plumbing plans and specifications for those plumbing installations to be located within the municipality's boundary limits and which require approval under sub. (1) (b).

(a) An agent municipality shall employ at least 2 full time plumbing inspectors who have been qualified by the department.

1. The primary duties of the plumbing inspectors shall include plumbing plan review.

2. The plumbing inspectors shall be Wisconsin licensed master or journeyman plumbers.

Note: See Appendix for listing of agent municipalities.

(b) An agent municipality may waive its jurisdiction for plan review and approval for any project, in which case plans shall be submitted to the department for review and approval.

(c) Agent municipalities may set by ordinance the fees for plan review services.

(3) **PRIORITY PLAN REVIEW.** An appointment may be made with the department to facilitate the examination of plumbing plans in less than the normal processing time. Complete plumbing plans along with the fee specified in s. Ind 69.23 (1) (d), shall be submitted to the department in person by appointment. The plans shall comply with all of the provisions of this section.

(4) **PLANS AND SPECIFICATIONS.** (a) At least 2 sets of plumbing plans and one copy of specifications which are clear, legible and permanent copies shall be submitted for examination and approval.

(b) If a submitter wants more than 2 sets of approved plans returned, the fees specified in Ind 69.23 shall accompany the plan submittal.

(c) All plans submitted for approval shall be accompanied by sufficient data and information for the department to judge if the plumbing and its performance will meet the requirements of this chapter and ch. ILHR 84.

1. Information to accompany the plans shall include the location or address of the plumbing installation and the name of the owner.

Note: See Appendix for further explanatory material.

2. Plans proposing the installation of a private interceptor main sewer which is to discharge to a municipal treatment facility shall:

a. Be accompanied by a letter from the appropriate designated planning or management agency indicating conformance with an approved areawide water quality management plan under ch. NR 121; and

b. Not be approved, if the municipality is ineligible for sanitary sewer extension approvals under s. NR 110.05.

3. Except as provided in subd. 4., plans proposing the installation of a building sewer for new construction which is to discharge to a municipal treatment facility shall:

a. Be accompanied by a letter from either the appropriate designated management agency or sanitary district indicating conformance with an approved areawide quality management plan; and

b. Not be approved, if the municipality is ineligible for sanitary sewer extension approvals under s. NR 110.05.

4. Plans proposing the installation of a building sewer for new construction which is to discharge to a municipal treatment facility shall not be required to comply with subd. 3., if:

a. The proposed installation is served by an existing building sewer which extends from the lot line to the public sewer; and

b. The proposed installation does not exceed the capacity of the existing building sewer or sewers.

Note: See Appendix for further explanatory material.

(d) Except as provided in par. (e), all plumbing plans and specifications shall be sealed or stamped and shall be signed by a Wisconsin registered architect, engineer or plumbing designer in accordance with ch. A-E 1.

(e) A master plumber may design and submit for approval plumbing plans and specifications for a plumbing system which the master plumber is to install. Each sheet of plans and specifications the master plumber submits shall be signed and dated and shall include the Wisconsin license number of the master plumber. Where more than one sheet is bound together into one volume, only the title sheet or index sheet need to be signed and dated by the master plumber responsible for their preparation, if the signed sheet clearly identifies all of the other sheets in the volume.

(5) **PERMIT TO START.** If the department review of the plumbing plans has not been completed within 30 days after complete plans, specifications, data and the appropriate fee have been received by the department, the department may issue, upon request, a permit to commence installation of the plumbing.

(a) The holders of the permit may proceed at their own risk without assurance that a conditional approval for the plumbing plans will be granted.

(b) The issuance of a permit shall not be construed as plan approval or approval for designs and installations which do not comply with chs. ILHR 82 to 84.

(c) All noncomplying portions of the plumbing installed under the permit prior to department approval shall be removed or replaced.

(6) **REVIEW FOR APPROVAL.** (a) *Conditional approval.* If, upon review, the department determines that the plumbing plans substantially conform to the provisions of chs. ILHR 82 to 84, a conditional approval, in writing, shall be granted. All noncode complying conditions stated in the conditional approval shall be corrected before or during installation.

(b) *Denial of approval.* If, upon review, the department determines that the plumbing plans do not substantially conform to the provisions of chs. ILHR 82 to 84, the request of conditional approval shall be denied in writing.

(7) **EVIDENCE OF APPROVAL.** The plumber responsible for the installation of the plumbing shall keep at the construction site at least one set of plans bearing the department's or the agent municipality's stamp of approval and at least one copy of specifications. The plans and specifications shall be open to inspection by an authorized representative of the department.

(8) **FEES.** Fees for plumbing plan review and petition for variance shall be submitted in accordance with s. Ind 69.23.

Note: See Appendix for further explanatory material.

(9) **REVISIONS.** All changes or modifications, which involve the provisions of chs. ILHR 82 to 84, made to plumbing plans and specifications, which have been granted approval under sub. (1), shall be submitted to the department or agent municipality for examination. All changes and modifications shall be approved in writing by the department or agent municipality prior to installation of the plumbing.

(10) **REVOCATION OF APPROVAL.** The department may revoke any approval, issued under the provisions of this chapter, for any false statements or misrepresentation of facts on which the approval was based.

(11) **DEPARTMENT LIMITATION AND EXPIRATION OF APPROVAL.** (a) A conditional approval of a plan by the department shall not be construed as an assumption by the department of any responsibility for the design; and the department does not hold itself liable for any defects in construction, nor for any damages that may result from the specific installation.

(b) Plan approval by the department or its authorized representative shall expire 2 years after the date indicated on the approval letter, if construction has not commenced within that 2 year period.

(12) **PETITION FOR VARIANCE.** (a) **Procedure.** The department will consider and may grant a variance to an administrative rule upon receipt of a fee and a completed petition for variance form from the owner, provided an equivalency is established in the petition for variance which meets the intent of the rule being petitioned. The department may impose specific conditions in granting a variance to promote the protection of the health, safety or welfare of the public. Violation of those conditions under which the variance is granted constitutes a violation of this chapter.

(b) *Petition processing time.* Except for priority petitions, the department shall review and make a determination on a petition for variance within 30 business days of receipt of all calculations, documents and fees required to complete the review. The department shall process priority petitions within 10 business days.

(13) **PENALTIES.** Penalties for violations of this chapter shall be assessed in accordance with ss. 145.12 and 145.25 (4), Stats.

History: Cr. Register, February, 1985, No. 350, eff. 3-1-85.

**ILHR 82.21 Testing and maintenance.** (1) **TESTING OF PLUMBING SYSTEMS.** Except as provided in par. (a), all new plumbing and all parts of existing systems which have been altered, extended or repaired shall be tested as specified in par. (d) to disclose leaks and defects before the plumbing is put into operation.

(a) *Waiver of testing.* The testing of the plumbing shall not be required where the installation does not include the addition, replacement, alteration or relocation of any water distribution, drain or vent piping.

(b) *Local inspection.* Where the plumbing is installed in a municipality having a local inspector, the testing of the plumbing shall be done in the presence of a plumbing inspector, except as provided in subd. 1. b.

1. **Notice of inspection.** a. The plumber responsible for the installation shall notify the plumbing inspector in person, by telephone or in writing when the work is ready for inspection.

b. If the inspection is not made by the end of the normal business day following the day of notification, not including Saturday, Sunday or legal holidays, the plumber may proceed with the testing and the installation.

2. **Preparations for inspection.** When the installation is ready for inspection, the plumber shall make such arrangements as will enable the plumbing inspector to inspect all parts of the plumbing system. The plumber shall have present the proper apparatus and appliances for making the tests, and shall furnish such assistance as may be necessary in making the inspection.

3. Rough-in inspection. A rough-in inspection shall be made when the plumbing system is roughed-in and before fixtures are set. Except as provided in subd. 1., plumbing work shall not be closed in, concealed, or covered until it has been inspected and approved by the plumbing inspector and permission is granted to do so.

4. Final inspection. a. Upon completion of the plumbing installation and before final approval is given, the plumbing inspector shall inspect the work.

b. When required by a municipality, the plumbing installation shall be subject to a final test conducted in accordance with par. (d) 7. The final test shall be observed by the plumbing inspector.

5. Reinspections. Whenever the plumbing official finds that the work or installation does not pass any initial test or inspection, the necessary corrections shall be made to comply with this chapter. The work or installation shall then be resubmitted for inspection to the plumbing inspector.

(c) *Inspection of one-and 2-family dwellings.* The inspection of plumbing installations for one- and 2-family dwellings shall be in accordance with ss. Ind 20.08 to 20.11.

(d) *Testing provisions.* 1. General. All plumbing shall be tested in accordance with provisions of this paragraph before being put into use.

a. Equipment, material and labor for tests. All equipment, material and labor required for testing a plumbing system or part thereof shall be furnished by the plumber responsible for the installation.

b. Exposure of work. Except as provided in subds. 2. and 5., all new, altered, extended or replaced plumbing shall be left uncovered and un-concealed until it has been tested. Where the work has been covered or concealed before it is tested, it shall be exposed for testing.

2. Building sewer and private interceptor main sewer. A building sewer and a private interceptor main sewer shall be inspected before being covered and shall be tested for leaks and defects with water or air before or after being covered in accordance with either subpar. a. or b. The test for leaks and defects may be applied to the entire building sewer or private interceptor main sewer or in sections.

a. Water test. The building sewer or private interceptor main sewer shall be tested by insertion of a test plug at the point of connection with the public sewer. The sewer shall then be filled with water under a head of not less than 10 feet. The water level at the top of the test head of water shall not drop for at least 15 minutes.

b. Air test. The air test shall be made by attaching an air compressor testing apparatus to any suitable opening, and, after closing all other inlets and outlets to the system, forcing air into the system until there is a uniform gauge pressure of 3 pounds per square inch. This pressure shall be held without introduction of additional air for a period of at least 15 minutes.

3. Building drain. The entire building drain with all its branches, receptacles and connections shall be brought so far as practical to the sur-  
Register, February, 1985, No. 350

face or grade of the basement floor and shall be tested with water or air in accordance with subd. 7.

4. Drain and vent systems. The piping of a drain and vent systems, including conductors, shall be tested upon completion of the rough piping installation with water or air in accordance with subd. 7.

5. Water service piping. Water service piping shall be inspected before being covered. The piping shall be tested and proved water tight under a water pressure not less than the working pressure under which it is to be used. The piping shall be tested before or after being covered or concealed. The water used for tests shall be obtained from a potable source of supply.

6. Water distribution system. The piping of a water distribution system shall be tested and proved water tight under a water pressure not less than the working pressure under which it is to be used. The water used for tests shall be obtained from a potable source of supply.

7. Test methods for drain and vent systems. A test for watertightness may be applied to an entire piping system or in sections after the rough piping has been installed.

a. Water test. If applied to the entire system, all openings in the piping shall be tightly closed, except the highest opening, and the system shall be filled with water to the point of overflow. If the system is tested in sections, each opening shall be tightly plugged except the highest opening of the section under test, and each section shall be filled with water, but a section shall not be tested with less than a 10 foot head of water. In testing successive sections, at least the upper 10 feet of the next preceding section shall be tested, so that no joint or pipe in the building, except the uppermost 10 feet of the system, is subjected to a test of less than a 10 foot head of water. The water shall be kept in the system or in the portion under test for at least 15 minutes before inspection starts. The system shall then be tight at all points.

b. Air test. The air test shall be made by attaching an air compressor testing apparatus to any suitable opening, and, after closing all other inlets and outlets to the system, forcing air into the system until there is a uniform gauge pressure of 5 pounds per square inch or sufficient to balance a column of mercury 10 inches in height. This pressure shall be held without introduction of additional air for a period of at least 15 minutes.

8. Final test. Where required by the local plumbing inspector, after the plumbing fixtures have been installed and the traps filled with water, the connections shall be tested and proved gas and watertight by either one of the methods specified in subpars. a. or b.

a. Smoke test. The smoke test shall be made by introducing a pungent, thick smoke, produced by one or more smoke machines, into the completed system. When the smoke appears at stack openings on the roof, the openings shall be closed and a pressure equivalent to a one inch water column shall be built and maintained for the period of the inspection.

b. Air test. The air test shall be made by attaching an air compressor testing apparatus to any suitable opening, and, after closing all other inlets and outlets to the completed system, forcing air into the system until a pressure equivalent to the gauge pressure of a one inch water column. This shall be accomplished by the use of "U" tube or manometer



inserted in the trap of a water closet. The pressure shall remain constant for the period of inspection without the introduction of additional air.

(2) **MAINTENANCE AND REPAIRS.** All plumbing systems, both existing and new, and all parts thereof, shall be maintained in a safe and sanitary condition. All devices or safeguards which are required by this chapter shall be maintained in good working order. The owner shall be responsible for the maintenance of plumbing systems.

(a) *Reduced pressure principle type backflow preventers.* Reduced pressure principle type backflow preventers shall be maintained and annually tested in accordance with ASSE 1013 and its appendix.

(b) *Existing systems.* Whenever it appears upon inspection that any part of an existing plumbing system is defective, or fails to conform to the requirements of this chapter and if failure tends to create a health hazard, it shall be repaired, renovated, replaced or removed.

(c) *Fixtures replaced.* When an old or defective fixture is removed, to be replaced by a new fixture, and no other fixture or piping is to be added or remodeled, it is not necessary to reconstruct the drain or vent piping to make it conform to the provisions of this chapter, unless the drain or vent piping is in a defective condition. Where the existing drain or vent piping does not conform to the provisions of this chapter, the department may require the new fixtures to be provided with deep seal traps.

(d) *Reconstruction.* When old or defective plumbing is to be remodeled, additional fixtures installed, or the whole plumbing system moved to another part of the building, the remodeled system shall be made to conform to this chapter.

(e) *Materials reused.* All plumbing fixtures, drain and vent pipes removed from a building, if found to be in good condition, may be reused, if the fixtures and pipes are approved by the department or local plumbing inspector and the owner of the building in which they are to be installed gives written consent.

(f) *Existing building sewers and drains.* Existing building sewers and drains may be used in connection with new buildings only when they are found on examination and test to conform to the requirements of this chapter governing building sewers and drains. If the existing work is found defective, the local or state inspector shall notify the owner of the changes necessary to make it conform to the requirements of this chapter.

(g) *Repairs.* All repairs to fixtures or piping shall be done in conformance with the provisions of this chapter, except repair clamps or bands may be used for emergency situations.

(h) *Demolition of structures.* When a structure is demolished or removed, all sanitary sewer, storm sewer and water supply connections shall be sealed and plugged in a safe manner.

(i) *Dead ends.* If a dead end is created in the removal of any part of a drain system, all openings in the drain system shall be properly sealed.

**Subchapter III**  
**Drain and Vent Systems**

**ILHR 82.30 Sanitary drain systems.** (1) **SCOPE.** The provisions of this section set forth the requirements for the design and installation of sanitary drain systems, including building drains and building sewers.

**Note:** The provisions for storm and clear water drain systems are specified in s. ILHR 82.36.

(2) **MATERIALS.** All sanitary drain systems shall be constructed of approved materials in accordance with ch. ILHR 84.

(3) **LOAD ON DRAIN PIPING.** (a) *Intermittent flow fixtures.* The load factor on drain piping shall be computed in terms of drainage fixture unit values specified in Table 82.30-1 for the corresponding fixture listed. Drainage fixture unit values for intermittent flow fixtures not listed in Table 82.30-1 shall be computed on the basis of one fixture unit equalling 7.5 gallons per minute of flow.

(b) *Continuous flow devices.* Drainage fixture unit values for continuous or semicontinuous flow devices such as pumps, ejectors, air conditioning equipment or similar devices shall be computed on the basis of one fixture unit for each 2 gallons per minute of flow rate of discharge into the drain system.

**Table 82.30-1**  
**DRAINAGE FIXTURE UNIT VALUES**

Type of Fixture	Drainage Fixture Unit Value (dfu)	Trap Size Minimum Diameter (in inches)
Automatic clothes washers,		
Commercial, individual.....	4	2
Commercial, large capacity.....	a	a
Self Service Laundry.....	3	1½
Residential.....	3	1½
Bathroom Group, includes: water closet, lavatory, bathtub or shower.....	6	
Bathtubs, all types <sup>b</sup> .....	2	1½
Bedpan Washer.....	6	2
Beer Tap.....	½	1½
Bidet.....	2	1½
Bottle Cooler.....	½	1½
Coffee Maker.....	½	1½
Cuspidor, fountain or dental.....	1	1½
Dipper Well.....	1	1½
Dishwasher, commercial type.....	c	c
Dishwasher, residential type.....	2	1½
Drinking Fountain.....	½	1½
Exhaust Hood Washer.....	4	2
Floor Drain,		
2 inch.....	2	2
3 inch.....	3	3
4 inch.....	4	4
Larger than 4 inch.....	4	d
Glass Filler.....	½	1½
Glass Washer.....	2	1½
Ice Chest.....	½	1½
Laundry Tray, 1 or 2 compartment.....	2	1½
Lavatory.....	1	1½
Refrigerated Food Display Case.....	1	1
Shower Stall		
Residential.....	2	2
Public, individual.....	2	2
Public, group.....	2 per shower head	2

Sinks,		
Cup .....	½	1¼
Factory, wash, per set of faucets .....	1	1½
Fountain wash up, per station .....	1	1½
Fountain or Bar, 4 compartments or less .....	3	1½
Food Waste Grinder, commercial 2 HP or less .....	2	1½ or 2 <sup>e</sup>
Food Waste Grinder, commercial 3 HP or more .....	3	3
Laboratory .....	2	1½
Laboratory, school .....	2	1½
Classroom .....	1	1¼
Pack or plaster .....	3	2
Residential, with or without food waste grinder .....	2	1½
Restaurant,		
Scullyery, pots and pans - 4 compartments or less .....	4	2
Food, rinsing, cleaning or thawing .....	3	2
Service Sink, Flushing Rim .....	6	3
Service Sink, 2 inch diameter, wall outlet .....	2	2
Service Sink, 3 inch diameter, wall outlet .....	3	3
Service Sink, 2 inch diameter, floor outlet .....	2	2
Service Sink, 3 inch diameter, floor outlet .....	3	3
Shampoo Sink, barber or beauty parlor .....	2	1½
Surgeons, wash up .....	3	1½
Wash Fountain, circular and semi-circular .....	3	2
Receptors of Indirect Wastes, gravity flow discharge		
1½ inch receptor outlet diameter .....	2	1½
2 inch receptor outlet diameter .....	3	2
3 inch receptor outlet diameter .....	4	3
4 inch receptor outlet diameter .....	6	4
larger than 4 inch receptor outlet diameter .....	8	f
Soda Dispenser .....	½	1¼
Sterilizers,		
Bedpan .....	4	2
Garbage can washer .....	3	3
Instrument or water .....	1	1½
Urinal .....	2	2
Water Closet, nonpublic .....	4	g
Water Closet, public .....	6	g

a Based on discharge rate of the fixture.

b Includes foot, sitz and infant baths and regular bathtubs with or without showers or whirlpool circulation piping.

c Based on discharge rates and number of outlets; a 4-inch diameter trap and drain pipe minimum recommended.

d Trap size corresponds to the size of the floor drain.

e Minimum trap size corresponds to size of the fixture's tail piece as provided by the manufacturer.

f Trap size corresponds to the size of the receptor drain outlet.

g Trap size specified in referenced standards of s. ILHR 84.20 (4) (a).

(4) SIZE OF DRAIN PIPING. (a) *Maximum loading*. 1. The total drainage load in any portion of drain piping shall not exceed the limits specified in Tables 82.30-2 and 82.30-3.

2. The drainage fixture unit values assigned to a receptor which is to receive only the indirect waste discharge from a relief valve on a domestic water heater may be disregarded when determining the minimum size of the building drain and building sewer. Any drain piping between the receptor and the building drain shall be sized by including the assigned fixture unit values for the type of receptor.

Note: See s. ILHR82.31 (17) for sizing requirements of combination drain and vent systems.

(b) *Minimum size of underground drain piping*. Any pipe of the drain system installed underground, other than the building sewer, shall not be less than 2 inches in diameter. Any portion of underground drain piping which is 2 inches in diameter shall not exceed a length of 20 feet.

(c) *Minimum size of building sewers.* 1. Gravity flow sewers. The minimum size of a gravity flow sanitary building sewer shall be 4 inches in diameter. A municipality or sanitary district by ordinance may require that portion of the building sewer between the lot line and the public sewer to be larger than 4 inches in diameter.

2. Pressurized sewers. a. Sewers pressurized through the use of sewage ejectors, sewage pumps or sewage grinder pumps shall be sized to maintain a minimum flow velocity of 2 feet per second and shall be in accordance with the ejector or pump manufacturer's recommendations.

b. Pressurized building sewers shall be sized not less than 2 inches in diameter for sewage ejectors and sewage pumps, and 1½ inches in diameter for all sewage grinder pumps.

(d) *Minimum size of private interceptor main sewers.* Private interceptor main sewers 6 inches or less in diameter shall not exceed the drainage fixture unit limits specified in Table 82.30-3. Private interceptor main sewers 8 inches or larger in diameter shall comply with the design flow criteria specified in ch. NR 110.

1. One- and 2-family dwellings. a. The portion of a private interceptor main sewer serving not more than 2 one-family dwellings and the attendant garages shall not be less than 4 inches in diameter.

b. The portion of a private interceptor main sewer serving more than 2 one-family dwellings and the attendant garages shall not be less than 6 inches in diameter.

c. The portion of a private interceptor main sewer serving one 2-family dwelling and its attendant garages shall not be less than 4 inches in diameter.

d. The portion of a private interceptor main sewer serving more than one 2-family dwelling and the attendant garages shall not be less than 6 inches in diameter.

2. Public buildings. A private interceptor main sewer serving public buildings shall be not less than 8 inches in diameter.

Note: See Appendix for further explanatory material.

(e) *Future fixtures.* Where provisions are made for the future installation of fixtures, the drainage fixture unit values of such fixtures shall be considered in determining the required sizes of drain and vent pipes. Construction to provide for future installations shall be terminated with a plugged fitting or fittings.

**Table 82.30-2**  
**HORIZONTAL AND VERTICAL DRAIN PIPING**

Pipe Diameter (in inches)	Maximum Number of Drainage Fixture Units Which May Drain Through Any Portion of Horizontal and Vertical Drain Piping			
	Horizontal Drain Piping <sup>a</sup>	Vertical Drain Piping of 3 Branch Intervals or Less <sup>b</sup>	Vertical Piping in Drain Stacks of more than 3 Branch Intervals <sup>b</sup>	
			Total Discharge from Side Connections into One Branch Interval	Total Discharge through Any Portion
1½	1	2	1	2
1½	3	4	2	8
2	6	10	6	24
3	20 <sup>c</sup>	48 <sup>d</sup>	20 <sup>c</sup>	72 <sup>d</sup>
4	160	240	90	500
5	360	540	200	1,100
6	620	960	350	1,900
8	1,400	2,200	600	3,600
10	2,500	3,800	1,000	5,600
12	3,900	6,000	1,500	8,400

Note a: Does not include building drains and building sewers.

Note b: Drain stacks may be reduced in size as the drainage load decreases to a minimum diameter of one half of the diameter required at the base of the stack, but not smaller than that required for a stack vent under s. ILHR 82.31 (14) (a).

Note c: Not more than 2 water closets or similar flush action type fixtures of 4 or more drainage fixture units.

Note d: Not more than 2 water closets or similar flush action type fixtures of 4 or more drainage fixture units within each branch interval nor more than 6 flush action type fixtures on the stack.

**Table 82.30-3**  
**BUILDING DRAINS, BUILDINGS SEWERS AND PRIVATE INTERCEPTOR MAIN SEWERS<sup>a</sup>**

Pipe Diameter (in inches)	Maximum Number of Drainage Fixture Units Which May Drain Through Any Portion of a Building Drain, Building Sewer or Private Interceptor Main Sewer			
	Pitch (inch per foot)			
	1/16	1/8	1/4	1/2
2	NP <sup>b</sup>	NP	6	9
3	NP	36 <sup>c</sup>	42 <sup>c</sup>	50 <sup>c</sup>
4	NP	180	216	250
5	NP	390	480	575
6	NP	700	840	1,000
8	1,400	1,600	1,920	2,300
10	2,500	2,900	3,500	4,200
12	2,900	4,600	5,600	6,700
15	7,000	8,300	10,000	12,000

Note a: Private interceptor main serves 6 inches or less in diameter, see s. NR 110.13 for private interceptor main sewers 8 inches or larger in diameter.

Note b: NP means Not Permitted.

Note c: Not more than 2 water closets or similar flush action type fixtures of 4 or more drainage fixture units.

(5) PITCH OF HORIZONTAL DRAIN PIPING. All horizontal drain piping 4 inches or larger in diameter shall be installed at a pitch which produces a computed velocity of at least 2 feet per second when flowing half full.

(a) *Horizontal branch drains.* 1. The minimum pitch of horizontal branch drains 2 inches or less in diameter shall be ¼ inch per foot.

2. The minimum pitch of horizontal branch drains larger than 2 inches in diameter shall be  $\frac{1}{8}$  inch per foot.

(b) *Building drains and building sewers.* 1. The minimum pitch of building drains shall be in accordance with Table 82.30-3.

2. a. The minimum pitch of building sewers 10 inches or less in diameter shall be in accordance with Table 82.30-3.

b. The minimum pitch of building sewers 12 inches or larger in diameter shall conform with the minimum pitches specified for municipal sewers in s. NR 110.13 (2) (c).

(c) *Private interceptor main sewers.* 1. The minimum pitch of private interceptor main sewers 6 inches or less in diameter shall be in accordance with Table 82.30-3.

2. The minimum pitch of private interceptor main sewers 8 inches or larger in diameter shall conform with the minimum pitches specified for municipal sewers in s. NR 110.13 (2) (c).

(6) **OFFSETS IN VERTICAL DRAINS.** Offsets in vertical drain piping shall be in accordance with this subsection.

(a) *Offsets of 45° or less.* 1. An offset in a vertical drain, with a change in direction of 45° or less from the vertical, shall be sized as a vertical drain piping in accordance with sub. (4).

2. Where a horizontal branch connects to a stack within 2 feet above or below an offset with a change of direction of 30 to 45° from the vertical and the offset is located below 2 or more branch intervals, a relief vent shall be installed in accordance with s. ILHR 82.31 (5).

(b) *Offsets of more than 45°.* A drain stack with an offset of more than 45° from the vertical shall be installed in accordance with subds. 1. to 5.

1. That portion of the stack above the highest offset fitting shall be sized as for vertical drain piping in accordance with sub. (4).

2. That portion of the offset between and including the offset fittings shall be sized as horizontal drain piping in accordance with sub. (4).

3. That portion of stack below the offset shall be not less than the size of the offset and not less than the size required for vertical drain piping in accordance with sub. (4).

4. No horizontal branch drain may connect to the stack offset downstream from the offset's highest fitting within the distance equal to 10 pipe diameters of the offset.

5. Where an offset is located below 2 or more branch intervals, a relief vent and a yoke vent shall be installed in accordance with s. ILHR 82.31 (5).

Note: See Appendix for further explanatory material.

(7) **HORIZONTAL BRANCH DRAIN CONNECTION AT BASE OF A STACK.** (a) A horizontal branch drain shall not connect to a building drain downstream from the base fitting of a drain stack 2 inches or larger in diameter within the distance equal to 10 pipe diameters of the building drain.

(b) A combination drain and vent branch shall not connect to a building drain downstream from the base fitting of a drain stack 2 inches or larger in diameter within the distance equal to 20 pipe diameters of the building drain.

Note: See Appendix for further explanatory material.

(8) PIPING CHANGES IN DIRECTION. Changes in the direction of drain piping shall be accomplished in accordance with the requirements of this subsection.

(a) *Fittings.* All changes in direction of flow in drain piping shall be made by the appropriate use of 45 degree wyes, long or short sweep quarter bends, sixth, eighth, or sixteenth bends, or by a combination of these or other equivalent fittings. Fittings which change the direction of flow for drain piping 8 inches or less in diameter shall conform to the minimum radii specified in Table 82.30-4.

Note: See Appendix for further explanatory material.

**Table 82.30-4**  
MINIMUM RADII OF FITTINGS  
(in inches)

Diameter of pipe (in inches)	Changes in Direction of Flow	
	Horizontal to Vertical	Vertical to Horizontal and Horizontal to Horizontal
1-1/4	1-1/8	2-1/4
1-1/2	1-3/8	2-3/4 <sup>a</sup>
2	1-7/8	3-1/4
3	2-7/8	4-1/16
4	3-3/4	4-7/8
5	4-1/2	6-1/2
6	5	7
8	6	8

Note a: The minimum radius may be reduced to 1 1/4 inches for the first 90° fitting downstream from a trap serving a lavatory or sink. This fitting may be a tee or quarter bend.

(b) *Blowout type fixtures.* Where blowout type fixtures are installed back to back, appropriate fittings shall be installed to prevent the passage of wastes from one fixture to the other.

(9) DRAIN FITTINGS AND CONNECTIONS. Drain fittings, connections, devices and methods of installation shall not obstruct or retard the flow of water, wastes, sewage or air in the drain system or venting system in an amount greater than the normal frictional resistance to flow, unless as otherwise permitted in this chapter or unless approved by the department.

(a) *Closet bend.* The reduction of a 4 × 3 inch closet bend or collar fitting from 4 inches to 3 inches shall not be considered an obstruction.

(b) *Side inlet tees or bends.* The side inlet of a low pattern or high pattern tee or bend shall not be used as a vent connection when the side inlet is placed in a horizontal position or when any arrangement of piping or fittings produces a similar effect.

Note: See Appendix for further explanatory material.

(c) *Prohibited fittings and connections.* The types of fittings and connections specified in subds. 1. to 5. shall not be used for drain piping:

1. A heel inlet bend when the heel inlet is in the horizontal position;
2. A fitting or connection which has an enlargement chamber or recess with a ledge or shoulder, or reduction in pipe area in the direction of flow;
3. A fitting which has running threads;
4. A fitting which has saddles, except as provided in sub. (11) (e) 1.; and
5. A connection by means of tapping or drilling of a drain or vent pipe, unless as otherwise approved by the department.

(10) **SUMPS, EJECTORS AND PUMPS.** (a) *Sumps.* 1. General. All sanitary building subdrains shall discharge into an approved, vented sump with an airtight cover. The sump shall be so located as to receive the sewage by gravity flow, and shall be located at least 25 feet from any water well.

2. Capacity. The minimum capacity of the sump shall be determined in accordance with the provisions of subpars. a. to e.

a. The water supply fixture unit method shall be used to determine peak input flow in gallons per minute; only the fixtures that drain to the sump shall be included.

Note: When converting water fixture units to gallons per minute it is permissible to calculate the load as a supply system with predominantly flush tanks.

b. The sump capacity between the lowest "pump on" switch level and the "pump off" switch level shall equal at least one minute of peak input, but in no case shall the pump that is actuated by the lowest "pump on" switch run less than 20 seconds.

c. Between the highest "pump on" switch level and the sump inlet, the sump shall hold the amount of input that exceeds the discharge of the pumping equipment in a 5 minute peak input period, but in no case shall the vertical distance between the switch and the inlet be less than 3 inches.

d. The low water level shall be maintained in accordance with the pump manufacturer's requirements, but shall not be less than 4 inches above the sump bottom.

e. Minimum sump diameter. Sumps containing one pump shall have an inside diameter of at least 24 inches. Sumps containing 2 pumps shall have an inside diameter of at least 30 inches.

Note: See Appendix for further explanatory material.

3. Vents. All sumps and all drains leading to a sump shall be vented in accordance with s. ILHR 82.31.

4. Materials. All sumps shall be constructed in a watertight manner of approved materials in accordance with ch. ILHR 84.

(b) *Ejectors and pumps.* 1. Where required. The liquid from all sanitary building sumps shall be lifted and discharged into the building sanitary drain system by automatic ejectors, pumps or any other equally efficient method approved by the department.



2. Duplex equipment. a. Public buildings. Duplex ejector or pumping equipment shall be installed in a public building where 3 or more water closets or more than 20 drainage fixture units discharge into a sump.

b. One- and 2-family dwellings. Duplex ejector or pumping equipment shall be installed where the sanitary wastes of 2 or more one- or 2-family dwellings discharge into a sump.

c. Operation. Where duplex ejector or pumping equipment is installed, appropriate devices shall be installed to automatically alternate operation of the pumps or ejectors and to operate both pumps or ejectors when one unit cannot handle the load.

3. Size. The size and design of an ejector or pump shall be determined by the capacity of the sump to be served, the discharge head and discharge frequency. All ejectors and pumps shall provide a minimum flow velocity of 2 feet per second in the forced discharge piping.

Note: Ejectors or pumps discharging to septic tanks may disturb the normal settling properties of the tank environment; contact the bureau of plumbing for more information.

a. Sewage grinder pumps. All sewage grinder pumps shall have a minimum 1½ inch diameter discharge opening and discharge piping.

b. Nongrinder-type sewage pumps. All nongrinder-type sewage pumps serving water closets shall be capable of passing a 2 inch diameter solid ball and shall have a minimum 2 inch diameter discharge opening and discharge piping. All other pumps handling sanitary wastes shall be rated by the manufacturer as an effluent pump, shall be capable of passing a ½ inch diameter solid ball and shall have a minimum 1½ inch diameter discharge opening and discharge piping.

4. Discharge connections. a. The discharge pipe from the ejector or pump shall be connected to the gravity drain by means of a wye pattern fitting. Where the fitting connects to a horizontal drain, the bottom of the wye branch of the fitting shall be located above the horizontal center line.

b. A full flow check valve shall be installed in the discharge piping from each ejector or pump.

c. Where duplicate ejector or pumping equipment is installed, each discharge pipe from an ejector or pump shall be provided with a gate or ball type valve installed downstream of each full flow check valve.

5. Discharge pipe air relief. Air relief valves shall be provided at all high points in the discharge piping of an ejector or pump where the piping arrangement creates an air trap.

6. Prohibited connections. No fixtures may be connected to the discharge pipe between the ejector or pump and the point where it enters the gravity drain.

7. Maintenance. All ejectors, pumps and like appliances shall receive care as needed to keep them in a satisfactory operating condition.

(11) BUILDING DRAINS AND BUILDING SEWERS. The interior plumbing of each building shall be entirely separated and independent of any other building's plumbing. All sanitary or special type drain systems shall be connected, by means of independent connections, with a public sewer,

approved private interceptor main sewer or private sewage system. No building sewer may pass under or through a building to serve another building.

(a) *Building drains.* 1. Elevation. a. All building drains shall be installed below the lowest floor levels on which fixtures may be installed if the public sewer, septic tank or private interceptor main sewer elevation permits.

b. A building drain serving only dwelling units may be located above ground in order to discharge to the building sewer by means of gravity flow. No above ground building drain may be located above the floor of the first story.

c. Where any portion of an above-ground building drain discharges to a vertical pipe, the building drain shall connect to the building sewer at an elevation at least 30 inches above the basement floor.

Note: See Appendix for further explanatory material.

2. Backwater protection. A building drain subject to backflow or backwater shall be protected with a backwater valve or with a sump with pumping equipment in accordance with sub. (10).

a. Backwater valves, when fully open, shall have a capacity not less than that of the pipes in which installed.

b. Backwater valves shall be so located as to be readily accessible for cleaning.

3. Floor drain required. Where a plumbing fixture or appliance is located on a floor which is entirely below grade, a floor drain shall be installed to serve that floor.

(b) *Building sewers.* 1. Minimum depth. a. The top of a building sewer shall be located at a depth of not less than 42 inches below finished grade, except as provided in subpar. b. or as approved by the department.

b. The top of a building sewer which discharges to a septic tank, holding tank or grease interceptor shall be located at a depth of not less than 18 inches below finished grade.

2. Protection from frost. a. Except as provided in subpars. c. and d., a building sewer shall be protected from frost in accordance with subd. 3. in areas where the top of the building sewer is located less than 60 inches below a surface area from which snow will be cleared.

b. Except as provided in subpars. c. and d., a building sewer shall be protected from frost in accordance with subd. 3. in areas where the top of the building sewer is located less than 42 inches below a surface which snow will not be cleared.

c. Where a building sewer discharges to a septic tank, holding tank, or grease interceptor, the portion of a building sewer which is within 30 feet from the connecting building drain and which is under a surface area from which snow will not be cleared shall not be required to be protected from frost.

d. Frost protection for a building sewer shall not be required where the predicted depth of frost as determined from Figure 82.30-1 and Table 82.30-6 does not extend below the top of the building sewer.

3. Insulations for building sewers. Where required by subd. 2. a. or 2. b., building sewer insulation for frost protection shall be provided in accordance with one of the methods specified in subpars. a. to c.

a. Extruded polystyrene. Extruded polystyrene foam insulation shall be installed at a depth of at least 18 inches below finished grade and at least 6 inches above the top of the sewer pipe. The minimum thickness and width of the foam insulation shall be determined from Figure 82.30-1 and Tables 82.30-5 to 82.30-7. If the insulation is to be installed more than 6 inches above the top of the sewer, the number of inches exceeding 6 inches shall be added to the width of insulation determined from Table 82.30-7.

b. Insulating concrete. Lightweight insulating concrete shall be installed to the depth of the spring line of the sewer and shall extend laterally at least 6 inches on both sides of the sewer. The minimum thickness of the insulating concrete shall be determined from Figure 82.30-1 and Table 82.30-5. The thickness shall be measured from the top of the sewer. The top of the insulation shall be installed at least 12 inches below finished grade.

c. Alternative methods. Alternative methods of frost protection shall be approved by the department.

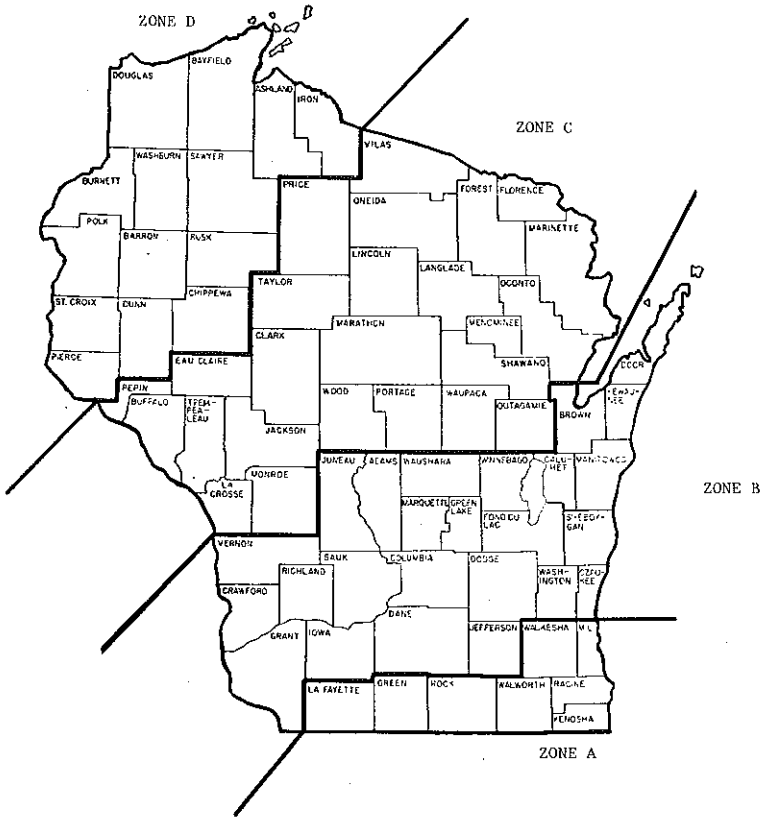

Figure 82.30-1  
INSTALLATION SITE ZONES

**Table 82.30-5**  
MINIMUM THICKNESS OF INSULATION

Installation Site Zone	Extruded Polystyrene Foam (in inches)	Insulating Concrete (in inches)
A	1.0	6
B	1.5	9
C	2.0	12
D	2.5	15

**Table 82.30-6**  
PREDICTED DEPTH OF FROST IN VARIOUS TYPES OF BACKFILL SOIL  
(in feet)

Soil Type	Installation Site Zone			
	A	B	C	D
Clay, Clay Loam	2.5	3.0	3.5	4.0
Silt Loam, Silty Clay Loam	3.5	4.0	4.5	5.5
Sandy Clay Loam	4.0	4.5	5.5	6.0
Sandy Loam, Loamy Sand	4.5	5.0	6.0	6.5
Sand	5.0	5.5	6.5	7.5
Gravelly Sand	6.0	7.5	9.0	10.0

**Table 82.30-7**  
MINIMUM WIDTH OF EXTRUDED POLYSTYRENE FOAM INSULATION  
(in feet)

Predicted Depth of of Frost (in feet)	Depth of Sewer (in feet)					
	2.0	2.5	3.0	3.5	4.0	4.5
2.5	2	NR				
3.0	3	2	NR			
3.5	4	3	2	NR		
4.0	5	4	3	2	NR	
4.5	6	5	4	3	2	NR
5.0	7	6	5	4	3	2
5.5	8	7	6	5	4	3
6.0	9	8	7	6	5	4
6.5	10	9	8	7	6	5
7.0	10	10	9	8	7	6
7.5	10	10	10	9	8	7
8.0	10	10	10	10	9	8
8.5	10	10	10	10	10	9
9.0	10	10	10	10	10	10
10.0	10	10	10	10	10	10

Note: NR means Not Required.

(c) *Location limitations.* Building drains and building sewers shall be separated from water wells by the following minimum distances:

1. Eight feet for building drains and building sewers of cast iron pipe;
2. Eight feet for building drains and building sewers of plastic pipe;
3. Twenty-five feet for building drains and building sewers of all other materials; and
4. Twenty-five feet for all pressurized building drains and building sewers.

Note: See s. ILHR 82.40 for provisions regarding the separation of water supply piping and building sewer piping.

(d) *Installation of building drains and building sewers.* 1. *Trenching.* All excavations for building drains and building sewers shall be open trench  
Register, February, 1985, No. 350

work, unless otherwise permitted by local ordinance or accepted by the local inspector.

2. Stable bottom. Where the bottom of the trench can be maintained in a stable condition and free of water during the time of installation the building drain and the building sewer shall be bedded and initially back-filled as specified in this subdivision. Grade, as used in this subdivision, shall mean the elevation of the bottom of the building drain or the building sewer.

a. Concrete, clay, plastic and asbestos-cement pipe. Except where sand is encountered, the trench bottom throughout its length shall be excavated to a depth at least 3 inches below the grade elevation and shall be brought back to grade with sand, pea gravel, or a graded stone bedding. The bedding material shall be of a size that all the material shall pass a  $\frac{3}{4}$  inch sieve. When sand is used as a bedding material it shall not contain excessive moisture and the bedding in the entire trench width shall be hand or mechanically tamped to compact it to a minimum of 90% Standard Proctor Density. All bedding shall be shaped to accommodate pipe bells or couplings. Initial backfill on the sides of the pipe and to a depth of 12 inches over the pipe shall be sand, gravel, crushed stone or excavated material which is neither corrosive nor organic in nature. A concrete floor may be placed over a building drain having less than 12 inches of initial backfill. Initial backfill material shall be of a size that all the material shall pass a one inch sieve. Initial backfill material shall be placed in increments not exceeding 6 inches in depth and shall be well tamped for the full width of the trench and for the full length of the sewer.

b. Cast iron pipe. Where the trench bottom does not contain stone larger than one inch in size or where bedrock is not encountered, the trench may be excavated to grade. Where stone larger than one inch in size or when bedrock is encountered, the trench shall be excavated to a depth at least 3 inches below the grade elevation and shall be brought back to grade with a bedding of sand, gravel, or crushed stone which shall be of a size that all the material shall pass a  $\frac{3}{4}$  inch sieve. The bedding material shall be shaped to accommodate the pipe bells or couplings. Initial backfill on the sides of the pipe and to a depth of 3 inches over the pipe for that part of the pipe laid on private property shall be well tamped sand, gravel, crushed stone or excavated material which is neither corrosive nor organic in nature. A concrete floor may be placed over a building drain having less than 3 inches of initial backfill. Initial backfill material shall be of a size that all the material shall pass a one inch sieve. For that portion of the sewer in the street right of way, the initial backfill material to a depth of 12 inches over the pipe shall be sand, gravel or crushed stone which shall be of a size that all the material shall pass a one inch sieve. Initial backfill material shall be placed in increments not exceeding 6 inches and shall be well tamped.

3. Unstable bottom. Where a mucky or unstable bottom is encountered in the trench, the required dry and stable foundation conditions shall be provided by sheathing driven and left in place to a depth of 48 inches below the trench bottom or to solid foundation at a lesser depth, the removal of wet and yielding material to a depth of 24 inches or to solid material, and replacement of the unstable material with limestone screenings, pea gravel or equivalent material for the bedding under the pipe. The trench bedding shall be shaped to accommodate pipe bells or

couplings. In lieu of the foregoing, the required dry and stable foundation conditions may be provided by installation of a longitudinally reinforced concrete cradle the width of the trench and at least 3 inches thick or by installation of a longitudinally reinforced concrete slab the width of the trench at least 3 inches thick and bedding material as provided for in subd. 2. Initial backfill material and its placement shall conform to that specified in subd. 2. All sheathing shall be cut off at a depth of 3 feet or more below the ground surface to prevent heaving due to frost action.

4. Backfill completion. Care shall be exercised in placing the balance of the backfill to prevent breakage of the pipe. Large boulders or rock, concrete slabs, or frozen masses shall not be used in the backfill. At least 36 inches of backfill cover shall be provided over the top of the pipe before the pipe trench is wheel-loaded.

5. Pipe openings protected. The ends of all pipes not immediately connected shall be closed so as to prevent the introduction of earth or drainage from an excavation.

(e) *Connection to public sewer.* The connections of building sewers to public sewers shall be in accordance with conditions of approval for the public sewer granted by the department of natural resources under s. 144.04, Stats.

1. Gravity public sewer. When a building sewer connection to the public sewer is not found within 3 feet of the point designated by the local governing body or its authorized representative, the connection shall be made in accordance with one of the provisions specified in subpars. a. to d.

a. A saddle fitting approved by the department and acceptable to the municipality or sanitary district shall be installed.

b. Where acceptable to the municipality or sanitary district a portion of the main sewer may be removed and a tee or wye fitting approved by the department may be inserted with compression joints in the public sewer acceptable to the municipality or the sanitary district. The insertion shall be made under the supervision of the authorized representative of the municipality or the sanitary district.

c. When the public sewer is concrete or clay, the end of the connecting sewer may be set upon or in an opening cut into the top half of the public sewer, but shall not protrude into the public sewer. The connection shall be secured by encasing the main sewer pipe and the connection in concrete at least 3 inches thick so as to assure permanency of the connection and adequate backing of the public sewer pipe.

d. In lieu of the use of a fitting and in the event that an opening cannot be located in the top half of the public sewer, a length of concrete or clay public sewer pipe may be removed and a section with a wye fitting shall be inserted in its place. The joints at the ends of the section shall be encased in concrete at least 3 inches thick. The connection or insertion shall be made under the supervision of the authorized representative of the municipality or the sanitary district.

2. Pressurized public sewer. Where a forced building sewer discharges to a pressurized public sewer, a full flow corporation cock, full flow curb stop, check valve and dresser type coupling shall be installed. The curb stop, check valve and dresser type coupling shall be installed on the

property as close as possible to the connection to the common forced main sewer. The check valve and dresser type coupling shall be accessible.

Note: See Appendix for further explanatory material.

(f) *Prohibited installations.* 1. Harmful discharge. No person may connect to a public sewer any building drain or building sewer through which is discharged any substance likely to cause undue corrosion, obstruction, nuisance, explosion or interference with sewage treatment processes.

2. Storm and clear water connections. Storm and clear water drains shall not discharge to a sanitary building drain or building sewer or to a private sewage disposal system. The building sanitary sewer and building storm sewer shall be installed as two separate piping systems and shall connect to the appropriate street or public sewer.

Note: See s. ILHR 82.36 for provisions relative to storm sewers.

(12) PRIVATE INTERCEPTOR MAIN SEWERS. (a) The connection of a private interceptor main sewer to a public sewer shall be in accordance with the conditions of approval for the public sewer granted by the department of natural resources under s. 144.04, Stats.

(b) Private interceptor main sewers which discharge to a municipal treatment facility shall be designed in accordance with the appropriate water quality management plan.

(c) All private interceptor main sewers shall be tested in accordance with s. ILHR 82.21.

(d) Private interceptor main sewers 6 inches or less in diameter shall be installed in accordance with the criteria for building sewers specified in sub. (11) (b) and (c) and (d) and (e).

(e) Private interceptor main sewers 8 inches or larger in diameter shall be:

1. Provided with frost protection in accordance with sub. (11) (b); and
2. Installed in accordance with the municipal sewer criteria specified in s. NR 110.13.

(13) LOCATION OF DRAIN PIPING. (a) Drain piping located below the ceilings of areas where food, ice or potable liquids are prepared, handled, stored or displayed shall be installed with the least number of joints and shall be installed in accordance with subs. 1. to 5.

1. All pipe openings through floors shall be provided with sleeves bonded to the floor construction and protruding not less than one inch above the top of the finish floor with the space between sleeve and the piping sealed.

2. Plumbing fixtures, except bathtubs and showers, shall be of the wall mounted type. Bathtubs shall have waste and overflow connections made above the floor and piped to a trap below the floor.

3. Floor and shower drains installed shall be equipped with integral seepage pans.



4. Cleanouts for piping shall be extended through the floor construction above.

5. Piping subject to operation at temperatures that will form condensation on the exterior of the pipe shall be thermally insulated.

(b) Where drain piping is located in ceilings of areas where food, ice or potable liquids are prepared, handled stored or displayed, the ceilings shall be of the removable type, or shall be provided with access panels in order to provide an access for inspection of the piping.

(c) Exposed drain piping shall not be located over a pool, surge tank or an open filter for a pool.

History: Cr. Register, February, 1985, No. 350, eff. 3-1-85.

**ILHR 82.31 Vents and venting systems.** (1) **SCOPE.** The provisions of this section set forth the requirements for the design and the installation of vents and venting systems.

(2) **MATERIALS.** All vents and venting systems shall be constructed of approved materials in accordance with ch. ILHR 84.

(3) **GENERAL.** (a) *Vents.* Every trap and trapped plumbing fixture shall be provided with an individual vent, except as otherwise permitted in this chapter. Vents and venting systems shall be designed and installed so that the water seal of a trap shall be subject to a maximum pneumatic pressure differential equal to one inch of water column.

(b) **MAIN STACK.** Each gravity-flow sanitary building sewer shall be served by at least one stack which extends from a building drain to a vent terminal or vent header. The stack shall be not less than 3 inches in diameter from the building drain to the vent terminal or vent header.

(4) **VENT STACKS AND STACK VENTS.** (a) *Where required.* Where individual vents, relief vents, or other branch vents are required, a vent stack and a stack vent shall be installed to serve all drain stacks of 2 or more branch intervals.

(b) *Installation.* 1. The connection of the vent stack to a drain stack shall be at or below the lowest branch drain connection to the drain stack. The connection to the drain stack shall be by means of a wye pattern fitting installed in a vertical portion of the stack.

2. A vent stack and a stack vent shall:

a. Extend to a vent terminal in accordance with sub. (16);

b. Connect to a vent stack which extends to a vent terminal; or

c. Connect to a stack vent at least 6 inches above the flood level rim of the highest fixture discharging into a drain stack.

3. Vent stacks and stack vents may connect into a common vent header and then shall extend to a vent terminal.

Note: See Appendix for further explanatory material.

(5) **RELIEF AND YOKE VENTS FOR STACK OFFSETS.** (a) *Offsets of 30 to 45°.* Where a horizontal branch drain connects to a drain stack within 2 feet above or below a stack offset with a change of direction of 30 to 45° from the vertical and the offset is located below 2 or more branch intervals, a Register, February, 1985, No. 350

relief vent shall be installed in accordance with par. (c), except where an offset of more than 45° from the vertical is located in the drain stack within 12 feet above the offset of 30 to 45 degrees.

(b) *Offsets of more than 45°.* Except as provided in subds. 1. and 2., where a drain stack has an offset of more than 45° from the vertical located below 2 or more branch intervals, a relief vent and a yoke vent shall be installed in accordance with par. (c).

1. Where an offset of more than 45° from the vertical is located in the drain stack within 12 feet above the lower stack offset, the installation of a yoke vent shall not be required.

2. Where the offset of more than 45° is located below the lowest branch drain connection, the installation of the relief vent shall not be required.

(c) *Installation.* 1. Relief vent. a. A relief vent serving a drain stack offset shall be installed as a vertical continuation of the portion of the stack below the offset or as a side connection to the portion of the stack below the offset. No drain connection may be installed between the offset and the side connection of the relief vent.

b. The connection of the relief vent to the drain stack shall be by means of a wye pattern fitting.

c. The connection of the relief vent to another vent shall be not less than 42 inches above the next higher floor level where plumbing fixtures are installed that discharge into the drain stack.

2. Yoke vent. a. A yoke vent serving a drain stack offset shall connect to the drain stack at or below the lowest branch drain connection to the portion of the drain stack above the offset.

b. The connection of the yoke vent to the drain stack shall be by means of a wye pattern fitting.

c. The connection of the yoke vent to another vent shall be not less than 42 inches above the next higher floor level where plumbing fixtures are installed that discharge into the drain stack.

Note: See Appendix for further explanatory material.

(6) **YOKE VENTS FOR STACKS OF MORE THAN 10 BRANCH INTERVALS.** Drain stacks of more than 10 branch intervals shall be provided with yoke vents.

(a) Yoke vents shall be installed not more than 10 branch intervals apart nor more than 10 branch intervals from the top or bottom of the drain stack.

(b) The connection of the yoke vent to the drain stack shall be by means of a wye pattern fitting.

(c) The connection of the yoke vent to another vent shall be not less than 42 inches above the next higher floor level where plumbing fixtures are installed that discharge into the drain stack.

(7) **RELIEF VENTS FOR BUILDING DRAINS.** A building drain with a change in elevation of 12 feet or more and at an angle of 45° or more from the horizontal shall be provided with a relief vent.

(a) The connection of the relief vent to the building drain shall be by means of a wye pattern fitting installed within 2 feet upstream of the top of the change in elevation.

(b) The connection of the relief vent to another vent shall be not less than 42 inches above the next higher floor level where plumbing fixtures are installed that discharge through the building drain.

Note: See Appendix for further explanatory material.

(8) **VENTS FOR SANITARY SUMPS.** Sanitary sumps shall be provided with a vent connecting either to the sump above the drain inlet or to the drain inlet within 12 inches of the sump.

(9) **FIXTURE VENTS.** (a) *Developed length between vent and trap.* Each fixture trap shall be protected with a vent located in accordance with the provisions of subs. 1. and 2.

1. Each fixture trap which is not an integral part of the fixture shall be protected with a vent so located that the developed length of the fixture drain piping from the trap weir to the vent connection is within the limits set forth in Table 82.31-1.

2. Each fixture trap which is an integral part of the fixture shall be protected with a vent so located that the developed length of the fixture drain piping from fixture outlet to the vent connection is within the limits set forth in Table 82.31-1. For a floor outlet water closet or similar fixture, the point where the fixture drain piping turns horizontal shall be considered as the fixture outlet.

(b) *Minimum distance.* A vent shall not connect to a fixture drain within the distance equal to 2 diameters of the drain piping from the weir of a trap.

Note: See Appendix for further explanatory material.

**Table 82.31-1**  
**MAXIMUM DEVELOPED LENGTH BETWEEN VENT AND TRAP**  
(in feet)

Diameter of Fixture Drain <sup>a</sup> (in inches)	Vent Connecting to Horizontal Drain Piping			Vent Connecting to Vertical Drain Piping					
				by means of a Sanitary Tee Fitting			by means of a Wye Pattern Fitting <sup>b</sup>		
	Pitch of Fixture Drain (inch per foot)			Pitch of Fixture Drain (inch per foot)			Pitch of Fixture Drain (inch per foot)		
	½	¾	2.5	½	¾	2.5	½	¾	2.5
1½	NP <sup>c</sup>	5.0	2.5	NP	3.5	2.0	NP	1.5	1.0
2	NP	6.0	3.0	NP	5.0	3.0	NP	4.0	2.0
3	NP	8.0	4.0	NP	6.0	4.0	NP	4.5	4.0
4	24	12.0	6.0	10.0	8.0	6.0	8.0	6.0	6.0
4 <sup>d</sup>	32	16.0	8.0	12.0	10.0	8.0	10.0	8.0	8.0

Note a: Diameters to be selected on the basis of the smallest drain pipe installed downstream from the trap serving a particular fixture.

Note b: The wye pattern fitting refers to a tee-wye fitting, a combination wye and eighth bend fitting or a wye and eighth bend combination of fittings with no more than one inch between the wye fitting and eighth bend fitting.

Note c: NP means Not Permitted.

Note d: The maximum developed length for fixture drains larger than 4 inches in diameter shall be approved by the department.

(10) **CIRCUIT VENTING.** In lieu of providing individual vents, a horizontal drain to which at least 2 but not more than 8 similar floor outlet fixtures, other than blowout type water closets, are connected in battery, may be vented by a circuit vent in accordance with pars. (a) to (e). For the purposes of this subsection flush action type floor outlet fixtures of 4 or more drainage fixture units shall be considered as one group of similar fixtures; all other types of floor outlet fixtures shall be considered as another group of similar fixtures.

(a) The circuit vent shall connect to the horizontal drain at a point between the 2 most upstream, floor outlet fixtures.

(b) 1. A circuit vented horizontal drain into which 4 or more floor outlet fixtures discharge shall be provided with a relief vent, unless the horizontal drain connects to a drain stack with no other drain connections located above the circuit vented horizontal drain. The relief vent shall connect to the circuit vented horizontal drain downstream of the most downstream fixture drain which is vented by the circuit vent and upstream of any other drain connections.

2. Two circuit vented horizontal drains serving a total of 8 fixtures, 4 on each branch, shall be provided with at least one relief vent, unless the horizontal drains connect to a drain stack with no other drain connections located above the circuit vented horizontal drains. One relief vent may serve both horizontal drains, if installed downstream of the point where the 2 horizontal drains are joined.

Note: See Appendix for further explanatory material.

(c) A horizontal drain served by a circuit vent shall not diminish in size from the connection to the drain stack to the circuit vent connection. Where a relief vent is installed, the horizontal drain served by the circuit vent shall not diminish in size from the relief vent connection to the circuit vent connection.

(d) Fixture drains served by a circuit vent shall conform to the provisions of sub. (9). The connection of the fixture drain to the branch drain served by the circuit vent shall be considered as the vent connection.

(e) Only wall outlet fixtures with a drainage fixture unit value of one or less which are served by individual vents or common vents may discharge into a horizontal drain served by a circuit vent.

(11) **COMMON VENTS.** In lieu of providing individual vents, fixtures may be common vented in accordance with pars. (a) and (b).

(a) *Vertical drains.* A common vent may serve 2 fixture traps where both fixture drains connect to a vertical drain at the same elevation. The drain connection of a blowout type fixture or a kitchen sink served by a common vent shall not be by means of a double sanitary tee fitting.

(b) *Horizontal branches.* The fixture drains from 2 lavatories or 2 compartments of one residential kitchen sink may connect to a horizontal branch drain without individual venting provided a common vent connects to the branch drain downstream of both fixture drains. Both fixture drains shall be of the same diameter. The developed length of the drain from the vent to the farthest trap shall conform to sub. (9).

Note: See Appendix for further explanatory material.

(12) **ISLAND FIXTURE VENTING.** Island plumbing fixtures may be vented in accordance with pars. (a) to (d).

(a) Island plumbing fixtures may be vented by extending an individual vent or a common vent as high as possible under the fixture enclosure and returning the vent vertically downward and connecting it to the fixture drain by means of a wye pattern fitting.

(b) Horizontal vent piping shall connect to the vertical section of the fixture vent and extend to a point where it can extend vertically to a vent terminal in accordance with sub. (16) or connect to another vent in accordance with sub. (15).

(c) Drainage fittings shall be used on all sections of the vent pipe below the floor level and a minimum slope of  $\frac{1}{4}$  inch per foot to the drainage point shall be provided.

(d) Cleanouts shall be provided on the vent piping in accordance with s. ILHR 82.35.

Note 1: See Appendix for further explanatory material.

Note 2: See sub. (17) for venting provisions relating to laboratory sinks.

(13) **WET VENTING.** In lieu of providing individual vents, fixtures may be wet vented in accordance with pars. (a) to (c).

(a) *Vertical wet vents.* 1. Where 2 wall outlet fixtures are located on the same floor level with their fixture drains connecting to the same vertical drain pipe at different elevations, the lower fixture drain may be wet vented in accordance with subpars. a. to e.

a. No other fixtures may discharge into the vertical drain pipe above or between the 2 wall outlet fixtures. Additional fixtures may discharge into the vertical drain pipe below the 2 wall outlet fixtures.

b. A branch vent shall connect to the vertical drain pipe immediately above the higher fixture drain connection.

c. The entire vertical drain shall be at least one pipe size larger than the upper fixture drain, but not smaller than the lower fixture drain.

d. Both fixture drains shall conform to sub. (9). The connection of the lower fixture drain to the vertical drain shall be considered as the vent connection.

e. The higher fixture drain may not serve a water closet or urinal.

Note: See Appendix for further explanatory material.

2. The fixtures of a nonpublic bathroom group may be wet vented in accordance with subpars. a. to e.

a. No other fixtures may discharge into the vertical drain pipe above or between the fixtures of the bathroom group. Additional fixtures may discharge into the vertical drain pipe below the fixtures of the bathroom group.

b. A branch vent at least 2 inches in diameter shall connect to the vertical drain pipe immediately above the highest fixture drain connection.

c. Each fixture drain of the fixtures to be wet vented shall connect individually to a vertical drain at least 3 inches in diameter.

d. Each fixture drain shall conform to sub. (9). The connection of the fixture drain to the vertical drain shall be considered as the vent connection.

e. The fixture drains of the water closet and bathtub or shower shall connect to the vertical drain at the same elevation. Where this connection is by means of a sanitary tee fitting with a side inlet, the centerline of the side inlet opening shall not be below the centerline of the larger opening.

(b) *Horizontal wet vents.* A drain from a lavatory or lavatories which are either provided with individual vents or a common vent may serve as the wet vent for not more than 2 bathtubs or showers and not more than 2 water closets in accordance with subs. 1. to 7. No other fixtures may discharge into or be served by the wet vent.

1. All of the fixtures shall be located in nonpublic bathroom groups.

2. The lavatories and bathtubs or showers shall have a common horizontal drain with the drain for the lavatories serving as a wet vent for the bathtubs or showers.

3. Where 2 bathtubs or showers are served by the same wet vent, their fixture drains shall connect independently to the common horizontal drain downstream of the vertical drain serving the lavatory or lavatories.

4. Where 2 bathtubs or showers and 2 water closets are served by the same wet vent a relief vent shall be provided, unless the wet vented horizontal drain connects to a drain stack with no other drain connections located above the wet-vented horizontal drain. The relief vent shall connect to the horizontal drain at a point downstream of the fixture drains for the water closets and upstream of any other fixture drain connections.

5. One or 2 water closets may connect to the common horizontal drain with the drain from the lavatories and bathtubs or showers also serving as a wet vent for the water closets. Where 2 water closets are served by the same wet vent, their fixture drains shall connect independently to the common horizontal drain at the same point.

6. The wet vent shall be at least 2 inches in diameter. No more than 4 drainage fixture units may discharge into a 2 inch diameter wet vent.

7. A branch vent shall connect immediately above the highest fixture drain connection and shall be sized in accordance with sub. (14).

(c) *Floor outlet fixtures.* An individual vent serving a floor outlet fixture, a common vent serving floor outlet fixtures, a circuit vent, a relief vent serving a circuit vented drain or a relief vent serving a wet vented horizontal drain may serve as a wet vent in accordance with subs. 1. to 4.

1. One or 2 wall outlet fixtures, each with a drainage fixture unit value of one or less may have their fixture drains connected individually into the individual vent, common vent, circuit vent or relief vent serving the floor outlet fixtures thereby forming a wet vent.

2. The wet vent shall be at least 2 inches in diameter.

3. The branch vent to which the wet vent connects shall be sized in accordance with sub. (14). The branch vent may serve the wall outlet fixtures in lieu of individual vents or a common vent.

4. The fixtures discharging into the wet vent shall be located on the same floor level as the floor outlet fixtures.

(14) **VENT SIZE.** (a) *Stack vents and vent stacks.* Stack vent and vent stack pipe sizes shall be determined in accordance with Table 82.31-2 on the basis of developed length and the diameter of the drain stack at its base.

1. The developed length of the stack vent shall be measured along the vent pipe, from the highest drain branch connection to the vent terminal or to the connection to a vent header.

2. The developed length of the vent stack shall be measured along the vent pipe from the vent stack base connection to the vent terminal or to the connection to a vent header.

Note: See Appendix for further explanatory material.

(b) *Vent headers.* 1. Vent header pipe sizes shall be determined in accordance with Table 82.31-3 with the number of drainage fixture units being the sum of the fixture unit loads of the stacks vented through that portion of the header. The diameter of a vent header shall not be less than any vent connecting to it.

2. The developed length of the vent header shall be measured along the pipe from the most distant vent stack or stack vent base connection to the vent terminal.

Note: See Appendix for further explanatory material.

(c) *Branch vents.* Branch vent pipe sizes shall be determined in accordance with Table 82.31-3. The developed length of the branch vent shall be measured along the pipe from the furthest fixture drain served by the branch vent to the point where it connects to a vent pipe of a larger diameter or to a vent terminal.

Note: See Appendix for further explanatory material.

(d) *Individual vents.* Individual vent pipe sizes shall be determined in accordance with Table 82.31-3. The developed length of an individual vent shall be measured along the vent pipe from the fixture drain served by the vent to the point where it connects to a vent pipe of a larger diameter or to a vent terminal.

Note: See Appendix for further explanatory material.

(e) *Common vents.* Common vent pipe sizes shall be determined in accordance with Table 82.31-3. The developed length of a common vent shall be measured along the vent pipe from the drain served by the vent to the point where it connects to a vent pipe of a larger diameter or to the vent terminal.

(f) *Circuit vents.* Circuit vent pipe sizes shall be determined in accordance with Table 82.31-3. The developed length of the circuit vent shall be measured along the vent from the connection with the branch drain

served by the vent to the point where it connects to a vent pipe of a larger diameter or to a vent terminal.

Note: See Appendix for further explanatory material.

(g) *Relief vents.* Relief vents shall be sized in accordance with the provisions of subds. 1. to 4. The developed length of a relief vent shall be measured along the vent from the connection with the branch drain served by the vent to the point where it connects to a vent pipe of a larger diameter or to a vent terminal.

1. Circuit vented branch drain. The diameter of a relief vent for a branch drain served by a circuit vent shall be at least one half the diameter of the branch drain. The maximum developed length shall be determined from Table 82.31-3 based on the number of drainage fixture units served by the vent.

2. Drain stacks. A relief vent serving a drain stack shall be sized as a stack vent in accordance with par. (a).

3. Building drain. The diameter of a relief vent serving a building drain, as required in sub. (7), shall be at least one half the diameter of the building drain. The maximum developed length shall be determined from Table 82.31-3 based on the number of drainage fixture units served by the vent.

4. Horizontal wet vent. The diameter of a relief vent serving a horizontal wet vent shall be at least 1½ inches. The maximum developed length shall be determined from Table 82.31-3 based on the number of drainage fixture units served by the vent.

(h) *Yoke vents.* A yoke vent serving a drain stack shall be sized as a vent stack in accordance with par. (a).

(i) *Vents for sumps.* 1. a. Except as provided in subpar. b., the size of a vent for a sanitary pump with other than a pneumatic ejector, shall be determined in accordance with Table 82.31-4.

b. The size of a vent for a sanitary sump located outside with other than a pneumatic ejector shall be determined in accordance with Table 82.31-4, but shall not be less than 2 inches in diameter.

2. The air pressure relief pipe from a pneumatic ejector shall not be connected to vent or vent system serving a sanitary drain system, storm drain system or chemical waste system.

a. The relief pipe shall be of a size to relieve the air pressure inside the ejector to atmospheric pressure, but shall not be less than 2 inches in diameter where the ejector is located outside and 1½ inches in diameter for all other ejector locations.

b. The vent shall terminate in accordance with the provisions of sub. (16).



Table 82.31-2

SIZE AND LENGTH OF VENT STACKS AND STACK VENTS

Diameter of Drain Stack at Base (inches)	Maximum Developed Length of Vent (feet)										
	Diameter of Vent (inches)										
	1½	1½ <sup>a</sup>	2	3	4	5	6	8	10	12	
1½	50	150	NL <sup>b</sup>								
2	NP <sup>c</sup>	50	150	NL							
3		NP	50	400	NL						
4		NP	20	180	700	NL					
5			NP	50	200	700	NL				
6			NP	20	70	200	700	NL			
8				NP	25	60	250	800	NL		
10					NP	25	60	250	800	NL	
12						NP	25	100	300	900	

Note a: Not more than 2 water closets or similar flush action type fixtures of 4 or more drainage fixture units.

Note b: NL means No Limit.

Note c: NP means Not Permitted.

Table 82.31-3

MINIMUM DIAMETERS AND MAXIMUM LENGTH OF INDIVIDUAL, COMMON, BRANCH AND CIRCUIT VENTS AND VENT HEADERS

Drainage Fixture Units (dfu)	Maximum Developed Length of Vent (feet)										
	Diameter of Vent (inches)										
	1½ <sup>a</sup>	1½ <sup>b</sup>	2	3	4	5	6	8	10	12	
2	50	NL <sup>c</sup>									
4	40	200	NL								
8	NP <sup>d</sup>	150	250	NL							
10	NP	100	200	NL							
24	NP	50	150	NL							
42	NP	30	100	500	NL						
72		NP	50	400	NL						
240		NP	40	250	NL						
500		NP	20	180	700	NL					
1100			NP	50	200	700	NL				
1900			NP	20	70	200	700	NL			
3600				NP	25	60	250	800	NL		
5600					NP	25	60	250	800	NL	

Note a: No water closets permitted.

Note b: Not more than 2 water closets or similar flush action type fixtures of 4 or more drainage fixture units.

Note c: NL means No Limit.

Note d: NP means Not Permitted.

**Table 82.31-4**  
**SIZE AND LENGTH OF VENTS FOR SANITARY SUMPS**

Discharge Capacity of Ejector (gpm)	Maximum Developed Length of Vent <sup>a</sup> (feet)				
	Diameter of Vent (inches)				
	1¼	1½	2	3	4
10	NL <sup>b</sup>				
20	270	NL			
40	72	160	NL		
60	31	75	270	NL	
80	16	41	150	NL	
100	10	25	97	NL	
150	NP <sup>c</sup>	10	44	370	NL
200		NP	20	210	NL
250		NP	10	132	NL
300		NP	10	88	380
400			NP	44	210
500			NP	24	130

Note a: The developed length of the vent is measured along the pipe from the connection to the sump, to the point where it connects to a vent pipe of a larger diameter.

Note b: NL means No Limit.

Note c: NP means Not Permitted.

(15) **VENT GRADES AND CONNECTIONS.** (a) *Vent grade.* All vent and branch vent pipes shall be graded and connected so as to drain back to a drain pipe by means of gravity.

(b) *Installation.* Vents shall be installed in accordance with subs. 1. to 3.

1. Except for wet vent piping, the connection of a vent to horizontal drain piping shall be at a point above the horizontal center line of the drain piping.

2. Except as provided in subs. (12) and (17), vent piping serving a wall-outlet fixture may not offset horizontally less than 36 inches above the floor, but in no case lower than the elevation of the highest flood level rim of any fixture served by the vent.

3. Vent piping may not connect to a branch vent less than 38 inches above the floor, but in no case lower than 2 inches above the elevation of the highest flood level rim of any fixture served by the vent.

Note: See Appendix for further explanatory material.

(16) **VENT TERMINALS.** All vents and vent systems shall terminate in the open air in accordance with this subsection.

(a) *Extension above roofs.* Extensions of vents through a roof shall terminate at least 8 inches above the roof. Where the roof is to be used for any purpose other than weather protection, the vents shall extend at least 7 feet above the roof.

(b) *Waterproof flashings.* The penetration of a roof system by a vent shall be made watertight with an approved flashing.

(c) *Prohibited uses.* Vent terminals shall not be used as flag poles, support for antennas or other similar purposes.

(d) *Location of vent terminals.* 1. A vent shall not terminate under the overhang of a building.

2. All vent terminals shall be located:

- a. At least 10 feet from an air intake;
- b. At least 5 feet from a power exhaust vent;
- c. At least 10 feet horizontally from or 2 feet above roof scuttles, doors and openable windows; and
- d. At least 5 feet from or 2 inches above parapet walls.

3. Where a structure has an earth covered roof extending from surrounding grade, the vent extension shall run at least 7 feet above grade and terminate with an approved vent cap. The portion of vent pipe outside the structure shall be without joints, except one fitting may be installed where the pipe leaves the top or side of the structure.

(e) *Extension through wall.* Where approved by the department, a vent may terminate through an exterior wall. Such a vent shall terminate at least 10 feet horizontally from any lot line and shall terminate downward. The vent shall be screened and shall comply with par. (d).

(f) *Extensions outside buildings.* Drain or vent pipe extensions shall not be located or placed on the outside of an exterior wall of any new building, but shall be located inside the building.

(g) *Frost closure.* For protection against frost closure, each vent terminal shall be at least 2 inches in diameter. Where it is necessary to increase the diameter of the vent, the change in diameter shall be made at least 6 inches inside the building.

(h) *Vents penetrating grade.* Vents penetrating grade shall be of cast iron above the point one foot below grade.

Note: See Appendix for further explanatory material.

(17) COMBINATION DRAIN AND VENT SYSTEMS. In lieu of providing individual vents, fixtures may be vented in accordance with pars. (a) to (c).

(a) *Stacks.* 1. A drain stack may serve as a combination drain and vent system for identical fixtures in accordance with subpars. a. to e.

a. The drain stack shall not serve more than 3 identical fixtures. Each fixture shall be located on a separate floor level.

b. The drain stack shall be limited to serving kitchen sinks with or without food waste grinders or dishwasher connections within dwelling units, drinking fountains and lavatories.

c. The drain stack shall not be offset horizontally above the lowest fixture drain connection.

d. The developed length of any fixture drain from the trap weir to the drain stack shall not exceed the limits specified in Table 82.31-1.

e. The drain stack shall be sized in accordance with Table 82.31-5 and shall extend undiminished in diameter from the connection to the building drain to a vent terminal in accordance with sub. (16).

Note: See Appendix for further explanatory material.

Table 82.31-5

Fixtures Connected	Size of stack (inches)
Drinking Fountains	1½
Lavatories	2
Kitchen Sinks	3

2. A drain stack may serve as a combination drain and vent system for a kitchen sink and a laundry tray in accordance with subpars. a. to d.

a. One kitchen sink within a dwelling unit, with or without a food waste grinder or dishwasher connection shall connect to the drain stack above the laundry tray. No other fixtures may connect to the drain stack.

b. The drain stack shall be at least 2 inches in diameter below the kitchen sink connection and it shall be at least 4 inches in diameter below the laundry tray connection.

c. In lieu of the minimum sizes as required in subpar. b., the entire stack below the kitchen sink connection may be 3 inches in diameter.

d. The drain stack shall not offset horizontally above the fixture drain connection for the laundry tray.

Note: See Appendix for further explanatory material.

(b) BUILDING DRAINS. A building drain may serve as a combination drain and vent system for floor drains and floor outlet fixtures in accordance with subds. 1. to 6.

1. A vent stack or a drain stack at least 2 inches in diameter shall be connected upstream of any building drain branch.

2. No more than 2 water closets may connect to the building drain by means of building drain branches.

3. a. That portion of the building drain between the connection of the building drain branch and the vent stack or drain stack required in subd. 1. shall be at least one pipe size larger than the minimum size permitted in Table 82.30-3 based on the total drainage fixture unit load.

b. The vent stack or drain stack required in subd. 1. shall be at least one-half the diameter of that portion of the building drain which is vented by the stack, but shall not be less than 2 inches in diameter. The stack shall not diminish in size from the building drain to its termination at a vent terminal.

4. The trap of a floor drain or a floor outlet fixture, except a water closet, connected to a building drain branch shall be at least 3 inches in diameter.

5. A building drain branch shall not connect to a building drain downstream from the base fitting of a drain stack 2 inches or larger in diameter within the distance equal to 20 pipe diameters of the building drain.

6. The pitch and the developed length of the building drain branch shall not exceed the limits specified in Table 82.31-1.

Note: See Appendix for further explanatory material.

(c) *Laboratory sink venting.* A horizontal drain may serve as a combination drain and vent system for island laboratory sinks in accordance with subs. 1. to 7.

1. A vent stack or a drain stack at least 2 inches in diameter shall be connected upstream of any fixture drain vented by the combination drain and vent system.

2. a. That portion of the horizontal drain between the connection of fixture drain and the vent stack or drain stack required in subd. 1. shall be at least one pipe size larger than the minimum size permitted in Table 82.30-2 based on total drainage fixture unit load.

b. The vent stack or drain stack required in subd. 1. shall be at least one-half the diameter of that portion of the horizontal drain which is vented by the stack, but shall not be less than 2 inches in diameter. The stack shall not diminish in size from the building drain to its termination at a vent terminal.

3. All fixture drains vented by the horizontal drain shall be at least 3 inches in diameter.

4. Fixture drains vented by the horizontal drain shall be at least 3 inches in diameter.

5. An individual vent or common vent shall be extended as high as possible under the sink enclosure and then returned vertically downward and connected to the horizontal drain. A cleanout shall be provided on the vent piping.

6. In lieu of connecting the vent to the horizontal drain which forms the combination drain and vent system, the vent may connect to a horizontal fixture drain vented by the combination drain and vent system. The pitch and developed length of the horizontal fixture drain shall not exceed the limits specified in Table 82.31-1.

7. Fixture drains to be vented by the horizontal drain shall not connect to a horizontal drain downstream from the base fitting of a drain stack 2 inches or larger in diameter within the distance equal to 20 pipe diameters of the horizontal drain serving the stack.

Note: See Appendix for further explanatory material.

(18) **PROHIBITED USES.** A vent or vent system shall not be used for purposes other than the venting of the plumbing system.

(a) *Boiler blowoff basin vents.* Vent piping from boiler blowoff basins shall not be connected to a vent or vent system serving a sanitary drain system, storm drain system or chemical waste system.

(b) *Chemical waste vents.* Vent piping for chemical waste systems shall not be connected to a vent system serving a sanitary drain system or storm drain system.

(c) *Steam vents.* Vents serving steam operated sterilizers, cleansing or degreasing equipment, pressing machines or any other apparatus which

normally discharges steam into the vent shall not be connected to a vent or a vent system serving a sanitary drain system, storm drain system or chemical waste system.

History: Cr. Register, February, 1985, No. 350, eff. 3-1-85.

**ILHR 82.32 Traps and direct fixture connections.** (1) **SCOPE.** The provisions of this section set forth the requirements for the types and installation of traps and direct fixture connections.

(2) **MATERIALS.** All traps and fixture connections shall be of approved materials in accordance with ch. ILHR 84.

(3) **GENERAL.** Each plumbing fixture, each compartment of a plumbing fixture and each floor drain shall be separately trapped by a water seal trap, except as provided in par. (a). A fixture shall not be double trapped.

(a) *Trap exceptions.* The plumbing fixtures listed in subsds. 1. to 3. shall not be required to be separately trapped:

1. Fixtures having integral traps;
2. Compartments of a combination plumbing fixture installed on one trap, provided:
  - a. No compartment is more than 6 inches deeper than any other;
  - b. The distance between the compartments' waste outlets farthest apart does not exceed 30 inches; and
  - c. No compartment waste outlet is equipped with a food waste grinder.
3. Storm drains as provided in s. ILHR 82.36 (14) (b).

(b) *Trap seals.* Each trap shall provide a liquid seal depth of not less than 2 inches and not more than 4 inches, except as otherwise specified in this chapter.

(c) *Loss of trap seal.* A trap seal primer valve may be installed on a trap subject to high rates of evaporation.

1. A trap seal primer valve shall be installed on a receptor of indirect wastes not subject to year round use.
2. Trap seal primer valves shall conform to ASSE 1018.

Note: A list of referenced standards is contained in ch. ILHR 84.

(d) *Design.* Traps shall be self-scouring and shall not have interior partitions, except where such traps are integral with the fixture. Uniform diameter P-traps shall be considered self-scouring.

(e) *Size.* Traps shall be of diameters not less than those specified in Table 82.30-1 of s. ILHR 82.30.

(f) *Prohibited traps.* The installation of the types of traps listed in subsds. 1. to 6. shall be prohibited:

1. Bell traps;
2. Drum traps, except where specifically approved by the department;
3. S-traps which are not integral parts of fixtures;

4. Separate fixture traps which depend on interior partitions for the trap seal;
5. Traps which depend upon moving parts to maintain the trap seal; and
6. Traps which in case of defect would allow the passage of sewer air.

(4) **INSTALLATION.** (a) *Setting of traps.* All traps shall be so located as to be accessible, rigidly supported and set true with respect to the water level and so located as to protect the water seals, and shall be protected from freezing and evaporation.

(b) *Distance from fixture drain outlets.* 1. Vertical distance. Except as provided in subpars. a. to c., the vertical distance between the top of the fixture drain outlet and the horizontal center line of the trap outlet shall not exceed 15 inches.

a. The vertical distance between the top of the strainer of a floor drain or the opening of a standpipe receptor and the horizontal center line of the trap outlet shall not exceed 36 inches.

b. The vertical distance between the top of the fixture drain outlet of a pedestal drinking fountain and the horizontal center line of the trap outlet shall not exceed 60 inches.

c. The vertical distance between the water level in the bowl of a floor outlet water closet and the center line of the horizontal portion of the fixture drain shall not exceed 36 inches.

2. Horizontal distance. The horizontal distance between the vertical center line of a fixture drain outlet and the vertical center line of the trap inlet shall not exceed 15 inches, except the horizontal distance for a pedestal drinking fountain shall not exceed 24 inches.

Note: See Appendix for further explanatory material.

(5) **DIRECT FIXTURE DRAIN CONNECTIONS.** (a) *Floor drains.* 1. Floor drains shall be so located as to be accessible for cleaning purposes.

2. A floor drain receiving the wash from garbage cans shall be at least 3 inches in diameter.

(b) *Kitchen sinks.* Horizontal drain piping serving a kitchen sink trap shall not connect to vertical drain piping by means of a double sanitary tee.

(c) *Water closets.* A water closet shall discharge through a drain pipe or fitting with a minimum diameter of 3 inches.

1. A floor mounted wall outlet water closet shall connect to a 4 inch or 4 × 3 inch closet collar fitting or to a horizontal or vertical carrier type fitting.

2. A floor outlet water closet shall connect to a 4 inch or 4 × 3 inch closet collar fitting. A 4 × 3 inch closet bend fitting may be installed where a 4 inch closet collar fitting is used.

3. A wall mounted wall outlet water closet shall connect to a horizontal or vertical carrier type fitting.

4. Two water closets discharging to a vertical drain from opposite sides by means of the same fitting shall be installed in accordance with subpars. a. and b.

a. Where the vertical drain is 3 inches in diameter, the fitting for floor outlet water closets shall be a 3 inch double wye pattern fitting.

b. Where the water closets are wall outlet types the fitting shall be a double wye pattern fitting or a carrier-type fitting.

History: Cr. Register, February, 1985, No. 350, eff. 3-1-85.

**ILHR 82.33 Indirect and local waste piping.** (1) **SCOPE.** (a) The provisions of this section set forth the requirements for the installation of indirect waste piping and local waste piping.

(b) Indirect waste piping and local waste piping draining the fixtures, appliances and devices having a public health concern, including but not limited to those listed in Table 82.33-1, shall be considered as plumbing and shall comply with the provisions of this section.

**Table 82.33-1**  
**TYPES OF FIXTURES, APPLIANCES AND DEVICES UTILIZING INDIRECT WASTE PIPING AND LOCAL WASTE PIPING**

Refrigerated Food Storage	Coffee Makers and Urns
Rooms and Compartments	Food Processing Equipment
Refrigerated Food Display Cases	Baptismal Founts
Ice Compartments	Clothes Washers and Extractors
Vending Machines	Dishwashers
Steam Tables	Stillls
Steam Kettles	Sterilizers
Potato Peelers	Bar and Soda Fountains
Egg Boilers	Boiler Blowoff Basin Outlet Drains

(2) **MATERIALS.** Indirect waste piping more than 30 inches in length and all local waste piping shall be of approved materials in accordance with ch. ILHR 84.

(3) **SIZE.** Indirect waste piping more than 30 inches in length and all local waste piping shall be sized in accordance with s. ILHR 82.30, except indirect or local waste piping not exceeding 20 feet in length for refrigerated food display cases may be one inch in diameter.

(4) **INSTALLATION.** Indirect waste piping and local waste piping shall be so installed as to permit access for flushing and cleaning.

(5) **TRAPS.** (a) *Indirect waste piping.* 1. Gravity flow indirect waste piping more than 30 inches in length shall be provided with a trap in accordance with s. ILHR 82.32 (4), except indirect waste piping draining a sterilizer shall not be trapped.

2. All indirect waste piping draining a refrigerated compartment shall be provided with a trap in accordance with s. ILHR 82.32 (4).

(b) *Local waste piping.* Local waste piping handling sanitary wastes and more than 30 inches in length shall be provided with a trap in accordance with s. ILHR 82.32 (4).



(6) **MAXIMUM LENGTH.** Indirect waste piping and local waste piping handling sanitary wastes shall not exceed 30 feet in length horizontally nor 15 feet in length vertically.

(7) **AIR-GAPS AND AIR-BREAKS.** All indirect waste piping and all local waste piping shall discharge by means of an air-gap or air-break into a receptor.

(a) *Air-gap installation.* 1. The distance of an air-gap between indirect waste piping one inch or less in diameter and the receptor shall be at least twice the diameter of the indirect waste piping.

2. The distance of an air-gap between indirect waste piping larger than one inch in diameter and the receptor shall be not less than 2 inches.

(b) *Air-break installation.* The air-break between indirect waste piping or local waste piping and the receptor shall be accomplished by extending the indirect waste piping or local waste piping below the flood level rim of the receptor.

Note: See Appendix for further explanatory material.

(8) **RECEPTORS.** A receptor receiving the discharge from indirect waste piping or local waste piping shall be of a shape and capacity as to prevent splashing or flooding. Receptors shall be installed in accordance with this subsection and shall be accessible.

(a) *Waste sinks and standpipes.* 1. A waste sink or a standpipe serving as a receptor shall have its rim at least one inch above the floor.

2. A waste sink or a standpipe serving as a receptor shall be individually trapped in accordance with s. ILHR 82.32.

(b) *Floor sinks.* A floor sink serving as a receptor shall be equipped with a removable metal basket over which the indirect waste piping or local waste piping is to discharge, or the floor sink shall be equipped with a dome strainer. Indirect waste piping or local waste piping shall not discharge through a traffic grate, but shall terminate over an ungrated portion of the floor sink.

(c) *Local waste piping.* 1. Local waste piping serving as a receptor shall discharge to a waste sink, standpipe or floor sink, except as provided in subd. 2.

2. Local waste piping serving as a receptor for a water heater safety relief valve may discharge to a floor drain.

(d) *Prohibited receptors.* Except as provided in subds. 1. and 2., a plumbing fixture which is used for domestic or culinary purposes shall not be used as a receptor for indirect waste piping or local waste piping.

1. The indirect waste piping of a portable dishwasher may discharge into a kitchen sink of a dwelling unit.

2. The indirect waste piping of an automatic clothes washer may discharge into a laundry tray.

Note: See Appendix for further explanatory material.

(9) INDIRECT WASTE PIPING REQUIRED. (a) *Boilers, pressure tanks and relief valves.* Boilers, pressure tanks, relief valves and similar equipment discharging to a drain system shall be by means of an air-gap.

1. Steam pipes shall not connect or discharge to any part of a plumbing system.

2. Waste water more than 160° F. in temperature shall not discharge into any part of a plumbing system.

(b) *Clear water wastes.* 1. Clear water wastes, except those from a drinking fountain, discharging to a drain system shall be by means of an air-gap.

2. The clear water wastes from a drinking fountain discharging to a drain system shall be by means of a direct connection.

(c) *Clothes washers.* 1. Residential types. Residential-type clothes washers shall discharge into the sanitary drain system by means of an air-break.

a. A standpipe receptor shall not extend more than 36 inches nor less than 18 inches above the top of the trap inlet.

b. The top of a standpipe receptor shall terminate at least 32 inches but not more than 42 inches above the floor on which the washer is located.

2. Self-service laundries. Pumped-discharge automatic clothes washing equipment in laundrettes, laundromats and self-service laundry establishments shall have the wastes discharge to a drain system by means of standpipes. The standpipes shall be installed in accordance with subd. 1.

a. The maximum number of washers which may be connected to a trap shall be in accordance with Table 82.33-2.

b. Washer wastes shall not be discharged to gutters, troughs, local waste piping, indirect waste manifold or other similar connections.

Table 82.33-2  
WASHER CONNECTIONS

Trap Diameter	Maximum Number of Washers
2 inches	2 machines
3 inches	3 machines
4 inches	4 machines

3. Commercial. Gravity discharge-type clothes washing equipment shall discharge by means of an air-break or by other approved methods into a floor receptor, trench or trough.

a. The receptor shall be sized to hold one full simultaneous discharge load from every machine draining into the receptor.

b. The size of the receptor drain shall be determined by the manufacturer's discharge flow rate and the frequency of discharge.

Note: See Appendix for further explanatory material.

c. All wastes from the washers shall flow through a commercial laundry interceptor as specified in s. ILHR 82.34.

(d) *Dishwashing machines.* 1. Residential-type. A residential-type dishwashing machine shall discharge to the sanitary drain system by means of a fixed air-gap or air-break located above the high water level of the dishwashing machine. The indirect waste piping or hose from the dishwashing machine shall not exceed a developed length of 10 feet. The indirect waste piping shall be installed in accordance with one of the methods specified in subpars. a. and b.

a. An air-gap or air-break may be located below a countertop. Where the air-gap or air-break is located below a countertop, the indirect waste piping from the dishwashing machine shall discharge into a standpipe. The standpipe shall be at least 1½ inches in diameter and shall extend at least 12 inches above the trap inlet.

b. An air-gap may be located above a countertop. Where the air-gap is located above a countertop, the indirect waste piping from a dishwashing machine shall discharge into either a standpipe or local waste piping. The standpipe shall be at least 1½ inches in diameter and shall extend at least 12 inches above the trap inlet. The local waste piping shall connect to the fixture drain of a kitchen sink above the trap inlet. Where a hose is used for local waste piping, the developed length shall not exceed 18 inches.

2. Commercial. Commercial dishwashing machines shall discharge into a sanitary drain system by means of a fixed air-gap into a trapped and vented receptor. The indirect waste piping shall not be more than 30 inches in length.

3. Prohibited installations. No dishwashing machine may discharge into or through a food waste grinder.

Note: See Appendix for further explanatory material.

(e) *Drips and drain outlets.* Appliances, devices and apparatus not defined as plumbing fixtures which have drip or drain outlets shall be drained through indirect waste piping into an open receptor by means of an approved air-gap or air-break.

(f) *Elevator pit subsoil and floor drains.* A subsoil or floor drain installed in an elevator pit shall discharge through indirect waste piping for disposal in accordance with s. ILHR 82.36 (3).

1. A sump pump shall not be located in an elevator pit.

2. The sump containing the pump for an elevator pit shall have a submerged inlet constructed to maintain a minimum 6 inch trap seal.

Note: See Appendix for further explanatory material.

(g) *Food handling establishments.* Plumbing fixtures, devices and appurtenances installed in food handling establishments engaged in the storage, preparation, selling, serving or processing of food shall be installed in accordance with this paragraph.

1. Bar and soda fountain sinks. Where a bar or soda fountain sink is so located that the trap for the sink cannot be vented as specified in s. ILHR 82.31, the sink drain shall discharge to the sanitary drain system through indirect waste piping.

a. Where the indirect waste piping is not trapped, the wastes shall be discharged by means of an air-gap.

b. Where the indirect waste piping is trapped, the wastes shall be discharged by means of an air-gap or air-break.

2. Beer taps, coffee makers, glass fillers and soda dispensers. The drip pan from a beer tap, coffee maker, glass filler, soda dispenser or similar equipment shall discharge to the sanitary drain system through indirect waste piping by means of an air-break or air-gap.

3. Novelty boxes, ice compartments and ice cream dipper wells. Novelty boxes, ice compartments and ice cream dipper wells shall discharge to the sanitary drain system through indirect waste piping by means of an air-gap.

a. The indirect waste piping shall not exceed 30 inches in length.

b. The indirect waste piping draining a novelty box or ice compartment shall not discharge or connect to the indirect waste piping or local waste piping of any other fixture, appliance or device other than a novelty box or ice compartment.

4. Refrigerated food storage rooms, compartments and display cases. Drains serving refrigerated food storage rooms, compartments or display cases shall discharge to the sanitary drain system through indirect waste piping. The indirect waste piping shall drain by gravity to a receptor by means of an air-gap or air-break. Where an air-break is installed, the flood level rim of the receptor shall be at least 2 inches below the top of fixture strainer or drain opening in the refrigerated room, compartment or display case.

5. Other equipment. Coffee urns, egg boilers, potato peelers, steam kettles, steam tables, vending machines and similar types of enclosed equipment shall discharge to the sanitary drain system through indirect waste piping by means of an air-gap.

Note: See Appendix for further explanatory material.

(h) *Sterilizers*. Appliances, devices or apparatus, such as stills, sterilizers and similar equipment requiring waste connections and used for sterile materials, shall discharge through indirect waste piping to the sanitary drain system by means of an air-gap.

Note: See s. ILHR 82.50 regarding sterilizer wastes.

(i) *Swimming pools*. 1. Waste water from swimming or wading pools, including pool drainage and backwash from sand filters, shall be discharged to the storm sewer through indirect waste piping.

2. Waste water from floor drains which serve interior walks around pools and backwash from diatomaceous earth filters shall be discharged to the sanitary sewer through indirect waste piping.

3. Where a recirculation pump is used to discharge waste pool water to the drain system, the pump shall discharge to the drain system through indirect waste piping.

4. All indirect waste piping serving pools and pool areas shall discharge by means of an air-gap.

## ILHR 82

5. The requirements for sewer connections as specified in ch. HSS 171 shall apply to all swimming pools.

(j) *Vacuum systems — central units.* Central vacuum units shall discharge by means of an air-gap or air break.

**Note:** For appliances, devices and equipment not included in this section or other sections contact the department for information and proposed installation review.

**History:** Cr. Register, February, 1985, No. 350, eff. 3-1-85.

**ILHR 82.34 Interceptors and catch basins for special and industrial wastes.** (1) **SCOPE.** The provisions of this section set forth the requirements for design and installation of interceptors and catch basins to handle special and industrial wastes.

(2) **MATERIALS.** All piping, interceptors and catch basins for special and industrial wastes shall be of approved materials in accordance with ch. ILHR 84.

(3) **GENERAL.** Any deleterious waste material which is discharged into a plumbing system shall be directed to an interceptor, catch basin or other approved device. The interceptor, catch basin or approved device shall be capable of separating the deleterious waste material from the normal sewage and retaining the deleterious waste material to facilitate its periodic removal or treatment or both.

(a) *Deleterious waste materials.* For the purpose of this subsection, deleterious waste materials include any waste material, other than that from dwelling units, which may:

1. Congeal, coagulate or accumulate in drains and sewers, thereby, creating stoppages or retarding the discharge flow;
2. Retard or interfere with municipal sewage treatment processes;
3. Pass through a treatment process and pollute the watercourse receiving the treatment effluent;
4. Create explosive, flammable, noxious, toxic or other hazardous mixtures of materials; or
5. Damage, destroy or deteriorate sewers or piping materials or structures.

**Note:** See Chapter Ind 8 as to flammable and combustible liquids.

(b) *Private disposal systems.* The special or industrial wastes from any plumbing system which are not discharged into a public sewer system shall be treated or disposed in compliance with the rules of the state agency having jurisdiction. The treatment or disposal system shall be installed so as not to endanger any water supply which is or may be used for drinking, culinary or bathing purposes, or which may create a nuisance, unsanitary conditions or water pollution.

(c) *Velocity control.* Interceptors, catch basins and other similar devices shall be designed, sized and installed so that flow rates shall be developed and maintained in a manner that solid and floating materials of a harmful, hazardous or deleterious nature will be collected in the interceptor for disposal.

(d) *Maintenance.* All devices installed for the purpose of intercepting, separating, collecting, or treating harmful, hazardous or deleterious materials in liquid or liquid-borne wastes shall be operated and cleaned of intercepted or collected materials or of any residual from treatment at such intervals which may be required to prevent their passage through the interceptor.

(e) *Service reassembly.* Any fixed orifice, vent or trap of an interceptor, catch basin or other similar device shall remain intact and shall not be removed or tampered with except for cleaning purposes. After service, all parts of the interceptor, collector or treatment device, such as baffles, weirs, orifice plates, channels, vents, traps, tops, and fastening bolts or screws shall be replaced in proper working position.

(f) *Location.* 1. Interceptors, catch basins and other similar devices shall be accessible for service, maintenance, repair and inspection.

a. No interceptor, catch basin or similar device may be surrounded or covered as to render it inaccessible for service or inspection.

b. No interceptor, catch basin or similar device may have its top located more than 6 feet above the surrounding floor.

c. Enough space shall be provided to enable the removal of any interior parts of the interceptor, catch basin or similar device.

d. At least 18 inches of clear space shall be provided above the top of the interceptor, catch basin or similar device.

2. An interceptor, catch basin, or similar device shall not be located within 25 feet of a water well.

(g) *Construction.* 1. Base. Site-constructed catch basins and interceptors shall have at least a 6 inch thick air-entrained concrete base with a minimum estimated compressive strength at 28 days of 3000 psi or an approved precast base.

2. Sides and tops. The sides and tops of poured-in-place concrete catch basins and interceptors shall be at least 6 inches thick air-entrained concrete with a minimum estimated compressive strength at 28 days of 3000 psi.

3. Prefabricated catch basins and interceptors. Prefabricated catch basins and interceptors shall be approved by the department prior to installation.

(h) *Disposition of retained materials.* Deleterious waste materials retained by an interceptor, catch basin or similar device shall not be introduced into any drain, sewer or natural body of water without approval of the state agency having jurisdiction.

(4) GARAGE CATCH BASINS AND INTECEPTORS. (a) *Public buildings.* Except as provided in subd. 1., the discharge waste from floor areas of public buildings on which self-propelled land, air or water vehicles can be driven, stored or serviced or on which engines or motorized equipment is serviced or stored shall be discharged through a garage catch basin or through a sand interceptor and an oil interceptor.

1. Exception. The discharge wastes of those floor areas where only vehicles such as forklift trucks are utilized shall not be required to be discharged through a garage catch basin or interceptor.

2. Design of garage catch basins. a. The base for a site-constructed garage catch basin shall extend at least 4 inches beyond the outside of the catch basin wall.

b. The catch basin shall have a minimum inside diameter or horizontal dimension of 36 inches and a minimum inside depth of 48 inches. The catch basin shall have a minimum liquid capacity of one cubic foot for each 300 square feet of surface area to be drained into the catch basin.

c. The outlet for a catch basin shall be at least 4 inches in diameter. The outlet shall be submerged to form a trap with a water seal of at least 6 inches. The bottom of the trap's water seal shall be at least 18 inches above the bottom of the catch basin. The outlet pipe shall be of cast iron material, if installed inside the catch basin.

d. The drain from the catch basin shall be provided with a cleanout extended to grade. The cleanout shall be sized in accordance with s. ILHR 82.35.

e. The waterline in the catch basin shall be at least 2 inches below horizontal drains discharging into the catch basin.

f. The catch basin shall be provided with an open grate cover of at least 24 inches in diameter.

g. Where the outlet for a catch basin is installed so that the waterline is more than 12 inches below the floor level, a local vent pipe of at least 4 inches in diameter shall be provided. The local vent pipe shall connect to the catch basin at least 2 inches above the waterline and shall terminate in accordance with s. ILHR 82.31 (16) or to the outside of the building with a cast iron return bend fitting terminating not less than one foot above grade.

h. Not more than 8 trapped floor drains of at least 3 inches in diameter may connect individually to the lowest horizontal portion of a local vent where that lowest horizontal portion of the local vent does not exceed a length of 100 feet. The change in elevation of the fixture drain between the trap weir of the floor drain and the local vent shall not exceed the diameter of the fixture drain pipe.

i. Trapped floor drains, at least 3 inches in diameter, may connect to a garage catch basin. The change in elevation of the fixture drain between the trap weir of the floor drain and the catch basin shall not exceed the diameter of the fixture drain pipe.

3. Trench drain. a. Each open grate trench shall discharge to a catch basin by means of a fixture drain of at least 4 inches in diameter.

b. The fixture drain from a trench drain shall extend at least 6 inches below the waterline of the catch basin.

c. The developed length of the fixture drain between the trench drain and the catch basin shall not exceed the distance equal to 24 times the diameter of the fixture drain.

Note: See Appendix for further explanatory material.

(b) *Garages for one- and 2-family dwellings.* 1. Floor drains serving garages for one- and 2-family dwellings shall be provided with a solid bottom sediment basket.

Note: See Appendix for further explanatory material.

2. Catch basins serving garages for one- and 2-family dwellings shall be in accordance with par. (a).

(c) *Grates for garage catch basins, floor drains and trenches.* A garage catch basin, floor drain and trench drain shall be provided with an approved, removable cast iron or steel grate of a thickness and strength for the anticipated loads. The grate shall have an available inlet area equal to at least the outlet drain for the catch basin, floor drain or trench drain.

(5) **GREASE INTERCEPTORS.** All plumbing installations for occupancies, other than dwelling units, where grease, fats, oils or similar waste products of cooking or food are introduced into the drain system shall be provided with interceptors in accordance with this subsection. All drains and drain piping carrying oil, grease or fats shall be directed through one or more interceptors as specified in par. (a).

(a) *General.* 1. Public sewers. All new, altered or remodeled plumbing systems which discharge to public sewers shall be provided with interior or exterior grease interceptors. Only kitchen wastes shall be discharged to an exterior grease interceptor.

2. Private sewage systems. All new, altered or remodeled plumbing systems which discharge to private sewage systems shall be provided with exterior grease interceptors.

a. Except as provided in subpar. b., only kitchen and food wastes shall be discharged to an exterior grease interceptor.

b. Where approved by the department combined kitchen wastes and toilet wastes may be discharged directly to a septic tank or tanks which conform to par. (b). The required capacity of a grease interceptor shall be added to the required septic tank capacity as specified in ch. ILHR 83.

3. Existing installations. The department may require the installation of either interior or exterior grease interceptors for existing plumbing installations where the waterway of a drain system, sewer system or private sewage system is reduced or filled due to congealed grease.

(b) *Exterior grease interceptors.* Exterior grease interceptors shall receive the entire waste discharge from kitchens or food processing areas. All exterior interceptors shall be designed and constructed in accordance with this paragraph, so as to constitute an individual structure.

1. Design. a. Liquid depth. The liquid depth of the interceptor shall not be less than 42 inches nor more than an average of 72 inches.

b. Rectangular tanks. A rectangular interceptor tank shall have a minimum width of 36 inches and a minimum length of 72 inches. The longest dimension of the tank shall be parallel to the direction of waste flow.

c. Horizontal-cylindrical tanks. A horizontal-cylindrical interceptor tank shall have a minimum inside diameter of 52 inches and a minimum length of 72 inches. The longest dimension of the tank shall be parallel to the direction of waste flow.



d. Vertical-cylindrical tanks. Vertical-cylindrical interceptor tanks shall have a minimum inside diameter of 72 inches.

e. Label. Each prefabricated interceptor tank shall be clearly marked to indicate liquid capacity and the name and address or registered trademark of the manufacturer. The markings shall be impressed into or embossed onto the outside wall of the tank immediately above the outlet opening. Each site-constructed concrete tank shall be clearly marked at the outlet opening to indicate the liquid capacity. The marking shall be impressed into or embossed onto the outside wall of the tank immediately above the outlet opening.

f. Inlets and outlets. The inlet and outlet openings of interceptor tanks or tank compartments shall be provided with cast-iron, open-end sanitary tee fittings or baffles of approved materials, so designed and constructed as to distribute the flow and retain the grease in the tank or tank compartments. The inlet and outlet openings shall be provided with stops or other provisions to prevent the insertion of drain piping beyond the inside wall of interceptor tank. The sanitary tee fittings or baffles shall extend at least 6 inches above the liquid level. At least 2 inches of clear space shall be provided above the top of the sanitary tee fittings or baffles. The sanitary tee fitting or baffle at the inlet opening shall extend below the liquid level of the tank a distance equal to  $\frac{1}{2}$  of the total liquid depth. The sanitary tee fitting or baffle at the outlet opening shall extend below the liquid level of the tank a distance equal to  $\frac{2}{3}$  of the total liquid depth. The waterline in the interceptor shall be at least 2 inches below the horizontal drain discharging to the interceptor.

g. Manholes. Each compartment of an interceptor tank shall be provided with at least one manhole opening located over either the inlet or outlet opening. Additional manhole openings shall be provided such that no interior compartment wall of a tank is more than 4 feet from the edge of the manhole opening. The distance between manhole openings serving the same compartment shall not exceed 8 feet. Manhole openings shall be not less than 24 inches in the least dimension. Manholes shall terminate at or above ground surface and be of approved materials. Steel tanks shall have a minimum 2 inch collar for the manhole extensions permanently welded to the tank. The manhole extension on fiberglass tanks shall be of the same material as the tank and an intergal part of the tank. The collar shall have a minimum height of 2 inches.

h. Manhole covers. Manhole risers for interceptor tanks shall be provided with a substantial, fitted, watertight cover of concrete, steel, cast iron or other approved material. Manhole covers shall terminate at or above grade and shall have an approved locking device.

i. Cover labels. A minimum 4 × 6 inch permanent label shall be affixed to the manhole cover, identifying the interceptor tank with the words GREASE INTERCEPTOR. Where the tank acts as the septic tank and grease interceptor the label shall identify it as such. The wording used on the warning label shall be approved by the department, as part of the materials approval for the tank under ch. ILHR 84.

j. Inspection opening. An inlet or outlet opening which does not have a manhole opening as specified in subpar. g. shall be provided with an airtight inspection opening located over the inlet or outlet. The inspection

opening shall be a cast iron pipe at least 4 inches in diameter. The inspection opening shall terminate at or above grade.

Note: See Appendix for further explanatory material.

2. Capacity and sizing. The minimum liquid capacity of a grease interceptor shall be determined in accordance with the provisions of this subdivision, except no grease interceptor may have a capacity of less than 1000 gallons.

a. The minimum capacity of a grease interceptor serving a restaurant with seating shall be equal to C, where

$$C = S \times H \times A$$

Where, S = Number of seats, with each drive-in car service space counting as 3 seats and each drive-up service window counting as 60 seats.

H = Hours per day that meals are served, at least 6 hours but not more than 12 hours.

A = Appliance factor:  
 0.75 for a kitchen with no dishwashing machine and no food waste grinder.  
 1.0 for a kitchen with either a dishwashing machine or a food waste grinder.  
 1.25 for a kitchen with both a dishwashing machine and a food waste grinder.

b. The minimum capacity of a grease interceptor serving a dining hall, hospital, nursing home, school kitchen, church kitchen or a kitchen for carryout or delivery service shall be equal to C, where:

$$C = \frac{M \times G \times H}{2 \times P}$$

Where, M = Meals served per day.  
 G = 3 gallons per meal served.  
 H = Hours per day that meals are served, at least 6 hours but not more than 12 hours.  
 P = Meal periods per day; 1, 2 or 3.

c. The minimum capacity of a grease interceptor as determined in subpar. a. or b. may be halved for establishments with all paper service, but shall not be less than 1000 gallons.

3. Installation. a. Grease interceptor tanks shall not be located within 5 feet of a building or any portion of the building; 5 feet of a water service; 2 feet of a lot line; 10 feet of a cistern; 15 feet of a pool; 25 feet of a reservoir or high water mark of a lake, stream, pond or flowage.

b. Where a grease interceptor tank is installed in groundwater, the tank shall be adequately anchored.

c. Grease interceptor tanks shall be installed on a bedding of at least 3 inches in depth. The bedding material shall be sand, gravel, granite, limerock or other noncorrosive materials of a size that all will pass through a 3/4 inch sieve.

d. The backfill material for steel and fiberglass grease interceptor tanks shall be as specified in subpar. c. for bedding and shall be tamped into place. The backfill material for concrete grease interceptor tanks shall be soil material, of a size that will pass through a 4 inch screen and shall be tamped into place.

e. All piping leading to and from a grease interceptor shall be of cast iron material to a point at least 3 feet beyond the excavation for the interceptor. The joints between piping and tank openings shall be caulked with lead and oakum or through other approved methods.

f. All joints on concrete risers and manhole covers for a grease interceptor shall be tongue and groove or shiplap type and sealed watertight using neat cement, mortar or bituminous compound. All joints on steel risers for a grease interceptor shall be welded or flanged and bolted and be watertight. All steel manhole extensions from a grease interceptor shall be bituminous coated inside and outside. All methods of attaching fiberglass risers for a grease interceptor shall be watertight and approved by the department.

(c) *Interior grease interceptors.* No interior grease interceptor may receive the waste discharge from a dishwasher, food waste grinder, or sanitizing compartment of a sink.

1. Flow rating. An interior grease interceptor shall be capable of accommodating a flow of at least 15 gallons per minute.

2. Flow rate related to connected capacity. Three-fourths of the total holding capacity in gallons of all fixtures and devices discharging to an interior grease interceptor, shall not exceed the value of the maximum flow rate which the interceptor can accommodate.

3. Grease holding capacity as related to flow rate. The grease holding capacity in pounds shall not be less than double the value of the maximum flow rate which the interceptor can accommodate.

4. Flow controls. Where required by the manufacturer, devices which control the rate of flow through an interior grease interceptor shall be installed.

a. The flow control devices shall be accessible for inspection, service and cleaning.

b. Flow controls shall be installed in the drain branch leading to each fixture and shall be so rated that the combined flow from all combinations of discharge will not develop either sufficient static or velocity head so the established flow rate of the interceptor can be exceeded.

Note: See Appendix for further explanatory material.

5. Flow control vents. Orifice type flow controls for an interior grease interceptor shall be vented in accordance with s. ILHR 82.31.

6. Prohibited locations and types. No water-cooled grease interceptor may be installed. No grease interceptor may be located where the surrounding temperatures, under operating conditions, are less than 40° F.

(d) *Prohibited treatment.* The introduction of grease or fat emulsifiers into a grease interceptor shall be prohibited.

(6) **AUTOMATIC CAR WASHES.** The wastes of floor drains and drain inlets of automatic car washes shall discharge through an approved car wash interceptor.

(a) *Design.* Except as provided in subds. 1. and 2. and par. (b), car wash interceptors shall be constructed and installed in accordance with sub. (4) (a).

1. The interceptor's outlet shall be submerged to form a trap with a water seal of at least 15 inches.

2. The bottom of the trap's water seal shall be at least 30 inches above the bottom of the interceptor.

(b) *Capacity.* The minimum liquid capacity of the interceptor shall be based on the maximum flow rate of water through the interceptor in gallons per minute.

1. Between the waterline and the bottom of the trap seal of the outlet, the interceptor shall have a capacity value equal to at least 5 times the maximum flow rate.

2. Below the bottom of the trap seal of the outlet, the interceptor shall have a capacity value equal to at least 15 times the maximum flow rate.

Note: See Appendix for further explanatory material.

(c) *Hand-held car washing wands.* The wastes of floor drains and drain inlets serving 2 or more hand-held car washing wands shall discharge through an approved car wash interceptor. The wastes of one hand-held car washing wand may discharge to a garage catch basin.

(d) *Recirculated water.* Where recirculated water is used for washing, the recirculated water shall be drawn from a separation chamber located upstream from the car wash interceptor.

(7) **COMMERCIAL LAUNDRIES.** Wastes from gravity dump-type clothes washing equipment shall be discharged through an approved laundry interceptor in accordance with this subsection.

(a) *Screening apparatus.* A laundry interceptor shall be equipped with a wire basket or other device which will prevent the passage of solids, ½ inch or larger in diameter, string, buttons and other detrimental materials into the drain system.

(b) *Trench type interceptors.* A floor receptor, trench or trough as specified in s. ILHR 82.33 (9) (c) 3., may serve as a laundry interceptor, if no oils or quantities of sand are discharged into it.

Note: See Appendix for further explanatory material.

(c) *In-line interceptor.* 1. In-line interceptors shall have a minimum inside diameter or horizontal dimension of 24 inches.

2. An in-line interceptor shall be provided with an air-tight cover.

3. An in-line interceptor shall be provided with a vent.

a. The vent shall extend from above the flow line to a vent terminal in accordance with s. ILHR 82.31 (16) or shall be connected to the venting system serving the sanitary drain system.

b. The diameter of the vent shall be at least one-half of the diameter of the interceptor's outlet, but not less than 2 inches.

4. The outlet for an in-line interceptor shall be at least 4 inches in diameter. The outlet shall be submerged to form a trap with a water seal of at least 12 inches. The bottom of the trap's water seal shall be at least 12 inches above the bottom of the interceptor.

5. The waterline in an in-line interceptor shall be at least 2 inches below the bottom of the inlet opening for the interceptor.

(8) **OIL AND FLAMMABLE LIQUIDS.** Oily and flammable wastes discharging to a building sewer shall be discharged through an approved interceptor. Where oily and flammable wastes may overflow by spillage or other circumstances, protective dikes or other similar devices shall be provided to prevent the wastes from entering the drain system.

(a) *Site-constructed interceptors.* 1. Garage catch basins. Site-constructed garage catch basins which serve as an interceptor for oily or flammable wastes shall be constructed and installed in accordance with sub. (4).

2. In-line interceptors. Site-constructed in-line interceptors for oily or flammable wastes shall be constructed and installed in accordance with this subdivision.

a. The base for an in-line interceptor shall extend at least 4 inches beyond the outside of the interceptor.

b. The in-line interceptor shall have a minimum inside diameter or horizontal dimension of 36 inches and a minimum inside depth of 48 inches. The interceptor shall have a minimum liquid capacity of one cubic foot for each 300 square feet of surface area to be drained into the interceptor.

c. The outlet for an in-line interceptor shall be at least 4 inches in diameter. The outlet shall be submerged to form a trap with a water seal of at least 6 inches. The bottom of the trap's water seal shall be at least 18 inches above the bottom of the interceptor. The outlet pipe shall be of cast iron material, if installed inside the interceptor.

d. The drain from the in-line interceptor shall be provided with a cleanout extended to grade. The cleanout shall be sized in accordance with s. ILHR 82.35.

e. The waterline in the in-line interceptor shall be at least 2 inches below all horizontal drains discharging into the interceptor.

f. Covered in-line interceptors shall be vented in accordance with par. (c).

(b) *Prefabricated oil interceptors and separators.* Prefabricated oil interceptors and separators shall be of a capacity for the anticipated load and shall be installed in accordance with the manufacturer's written specifications. A manufacturer's rated capacity shall be accepted upon the approval of the department.

1. An oil interceptor or separator shall be provided with an oil storage tank for storing the residue from the interceptor or separator.

2. The oil storage tank shall be provided with a high liquid warning device which will be activated when the liquid level is less than 6 inches below the inlet pipe.

a. The warning device shall be either an audible or illuminated alarm.

b. Illuminated alarms shall be conspicuously mounted.

Note: Electrical installations are to be in accord with ch. ILHR 16.

(c) *Venting.* Oil and flammable interceptors and separators shall be so designed to prevent the accumulation of explosive gases.

1. A covered interceptor or separator shall be provided with an individual vent of at least 3 inches in diameter. The vent shall extend from the top of the interceptor or separator or as high as possible, from the side of the interceptor or separator to a point at least 12 feet above grade.

2. The drain pipe to the interceptor or separator shall be provided with a fresh air inlet connected within 2 feet of the inlet of the interceptor or separator. The fresh air inlet shall terminate at least one foot above grade, but not less than 6 feet below the terminating elevation of the vent serving the interceptor or separator. The fresh air inlet shall be at least 3 inches in diameter.

Note: See Appendix for further explanatory material.

(9) **BOTTLING ESTABLISHMENTS.** Wastes containing glass of bottling establishments shall be discharged through an interceptor.

(10) **DAIRY PRODUCT PROCESSING PLANTS.** Dairy wastes from dairy product processing plants shall be discharged through an interceptor.

(11) **MEAT PROCESSING PLANTS AND SLAUGHTERHOUSES.** The wastes from meat processing areas, slaughtering rooms and meat dressing rooms shall be discharged through an approved interceptor to prevent the discharge of feathers, entrails, blood and other materials.

(12) **SAND INTERCEPTORS.** Sand interceptors and other similar interceptors for heavy solids shall be so designed and located as to be accessible for cleaning. The outlet for the interceptor shall be submerged to form a trap with a water seal of at least 12 inches.

(13) **PLASTER AND HEAVY SOLIDS TRAP TYPE INTERCEPTORS.** Plaster sinks shall be provided with plaster and heavy solids trap type interceptors.

(a) The interceptor shall be installed as the fixture trap.

(b) The drain piping between the sink and the interceptor shall not exceed a length of 36 inches.

Note: See Appendix for further explanatory material.

(14) **CHEMICAL WASTE PIPING SYSTEMS.** All chemical wastes having a pH level of less than 5.5 or more than 10.0 shall discharge to a holding tank for proper disposal or to a drain system in accordance with this subsection.

(a) *Chemical dilution and neutralizing basins.* 1. All chemical wastes discharging into a drain system shall be diluted, neutralized or treated to a pH level of 5.5 to 10.0 by passing through an approved dilution or neutralizing basin before discharging to a building sewer.

2. Dilution and neutralizing basins shall have the minimum retention capacities as specified in Table 82.34. For quantities of fixtures exceeding 150 sinks or for special uses or installations, the department shall be consulted as to the minimum capacity of the basin.

Table 82.34

## MINIMUM CAPACITIES FOR DILUTION AND NEUTRALIZING BASINS

Maximum Number of Sinks	Minimum Retention Capacity in Gallons
1	5
4	15
8	30
16	55
25	100
40	150
60	200
75	250
100	350
150	500

3. Where a sufficient supply of diluting water cannot be provided to a dilution or neutralizing basin, the basin shall be filled with marble or limestone chips of not less than one inch nor more than 3 inches in diameter to the level of the basin's outlet.

4. Either the inlet or outlet of a dilution or neutralizing basin shall be submerged to form a trap with a water seal of at least 4 inches.

(b) *Vents*. Vents for chemical waste systems shall be sized and installed in accordance with s. ILHR 82.31.

1. Dilution and neutralizing basins with submerged inlets shall have a sanitary vent connected to the basin and a chemical waste vent connected to the inlet pipe. The pitch and the developed length of the drain between the submerged basin inlet and the chemical waste vent shall be in accordance with Table 82.31-1.

2. Dilution and neutralizing basins with submerged outlets shall have a chemical waste vent connected to the basin and a sanitary vent connected to the outlet pipe. The pitch and the developed length of the drain between the submerged basin outlet and the sanitary vent shall be in accordance with Table 82.31-1.

Note: See Appendix for further explanatory material.

History: Cr. Register, February, 1985, No. 350, eff. 3-1-85.

**ILHR 82.35 Cleanouts.** (1) **SCOPE.** The provisions of this section set forth the requirements for the installation of cleanouts and manholes for all drain piping.

(2) **MATERIALS.** Cleanouts shall be constructed of approved materials in accordance with ch. ILHR 84.

(3) **WHERE REQUIRED.** (a) *Horizontal drains.* All horizontal drains within or under a building shall be accessible through a cleanout. Cleanouts shall be located so that the developed length of drain piping between cleanouts does not exceed 75 feet. For the purpose of this requirement, cleanouts in drain stacks may serve horizontal drains.

Note: See Appendix for further explanatory material.

(b) *Sanitary building sewers.* 1. Sanitary building sewers 6 inches or less in diameter shall be provided with cleanouts or manholes such that:

Register, February, 1985, No. 350

- a. Cleanouts are located not more than 100 feet apart;
  - b. Manholes are located not more than 400 feet apart;
  - c. The distance from a cleanout to a manhole located upstream is not more than 200 feet; or
  - d. The distance from a manhole to a cleanout located upstream is not more than 300 feet.
2. Sanitary building sewers 8 inches or larger in diameter shall be provided with manholes at:

- a. Every change in direction of 45 degrees or more;
- b. Every change in pipe diameter; and
- c. Intervals of not more than 400 feet.

(c) *Storm building sewers.* 1. Storm building sewers 10 inches or less in diameter shall be provided with cleanouts or manholes such that:

- a. Cleanouts are located not more than 100 feet apart;
- b. Manholes are located not more than 400 feet apart;
- c. The distance from a cleanout to a manhole located upstream is not more than 200 feet; or
- d. The distance from a manhole to a cleanout located upstream is not more than 300 feet.

2. Storm building sewers 12 inches or larger in diameter shall be provided with manholes or storm drain inlets with an inside diameter of at least 36 inches at:

- a. Every change in direction of 45 degrees or more;
- b. Every change in pipe diameter; and
- c. Intervals of not more than 400 feet.

(d) *Private interceptor main sewers.* 1. Private interceptor main sewers 5 inches or less in diameter shall be provided with a cleanout or manhole at the most upstream point of the private interceptor main sewer and such that:

- a. Cleanouts are located not more than 100 feet apart;
- b. Manholes are located not more than 400 feet apart;
- c. The distance from a cleanout to a manhole located upstream is not more than 200 feet; or
- d. The distance from a manhole to a cleanout located upstream is not more than 300 feet.

2. Private interceptor main sewers 6 inches or larger in diameter shall be provided with a manhole at:

- a. The most upstream point of the private interceptor main sewer;
- b. Every change in direction;



- c. Every change in pipe diameter; and
- d. Intervals of not more than 400 feet.

(e) *Junction of building drain and building sewer.* A cleanout shall be provided near the junction of a building drain and a building sewer.

1. The cleanout shall be located within 5 feet of where the building drain and the building sewer connect. The cleanout may be located either inside or outside the building.

2. A cleanout in a drain stack may serve as the cleanout at the junction of the building drain and building sewer, if the stack is within 5 feet of where the building drain and building sewer connect.

(f) *Stacks.* Where a cleanout is provided in a drain stack, the cleanout shall be located 28 to 60 inches above the lowest floor penetrated by the stack.

(g) *Branches.* Cleanouts shall be provided in connection with batteries of fixtures at such points that all parts of the branch drain pipes may be reached for cleaning or removal of stoppages. For the purposes of this requirement, removable fixture traps may serve as a cleanout opening.

(h) *Greasy wastes.* Drain pipes carrying greasy wastes shall be provided with cleanouts located not more than 40 feet apart and at all changes in direction of more than 45.

(i) *Double sanitary tees.* A cleanout shall be provided immediately above or below a double sanitary tee drain fitting which is installed in a vertical drain pipe of less than 3 inches in diameter, unless a stack cleanout is provided in accordance with par. (e).

(j) *Traps.* All fixture traps shall be designed and installed so that stoppages may be removed from the traps.

1. Except as provided in subd. 2., all fixture traps 2 inches or less in diameter shall have cleanouts of the screw plug or removable dip type. Where the dip is removable, the coupling nut on the discharge side of the trap shall be within the dip of the trap.

2. Traps for urinals rising from the floor and traps serving showers, bathtubs and floor drains, when inaccessible, shall be so installed as to make the removable inlet serve as a cleanout for the trap.

(k) *Conductors.* Where a cleanout is provided in a conductor, the cleanout shall be located 28 to 60 inches above the lowest floor penetrated by the conductor.

(1) *Sampling manholes.* Municipalities or sanitary sewage districts by ordinance or rule may require the installation of sampling manholes for periodic sewage monitoring.

Note: The installation of sampling manholes may be needed for the monitoring of industrial wastes under chs. NR 200 to 299.

(4) **DIRECTION OF FLOW.** Every cleanout shall be installed so as to open in the direction of the waste flow or at a right angle thereto.

(5) **ACCESSIBILITY.** Cleanout plugs shall not be covered with cement, plaster, or any other similar permanent finishing material.

(a) *Underground piping.* Cleanouts installed in underground drain piping shall be extended vertically to or above the finish grade.

1. The cleanout extension to grade shall connect to the drain piping through a wye pattern fitting.

2. A cleanout located outside of a building shall be provided with a frost sleeve.

a. The frost sleeve shall be of a material approved for building sewers in accordance with s. ILHR 84.30 (1) (c).

b. Where a cleanout is located in an area subject to vehicular traffic the top of the frost sleeve shall terminate in a concrete pad at least 4 inches thick and extending at least 9 inches from the sleeve on all sides, sloping away from the sleeve.

c. The bottom of the frost sleeve shall terminate 6 to 12 inches above the top of the drain piping.

d. The frost sleeve shall have a removable watertight top of sufficient thickness and strength to sustain the weight of anticipated traffic.

Note: See Appendix for further explanatory material.

(b) *Concealed piping.* Cleanout access for drain piping located in concealed spaces shall be provided by either extending the cleanout to at least the surface of a wall or floor or by providing access panels of a sufficient size to permit removal of the cleanout plug and proper cleaning of the pipe.

(6) **CLEANOUT SIZE.** Cleanouts and cleanout extensions shall be sized in accordance with Table 82.35.

**Table 82.35**  
**CLEANOUT SIZES**

Diameter of Pipe Served by Cleanout (inches)	Minimum Diameter of Cleanout Extension (inches)	Minimum Diameter of Cleanout Opening (inches)
1½	1½	1½
2	1½	1½
3	3	2½
4	4	3½
5	5	4
6	6	5
8 and larger	6	6

(7) **PROHIBITED USE OF CLEANOUT OPENINGS.** Cleanout openings shall not be used for the installation of fixtures or floor drains, except where another cleanout of equal access and capacity is provided.

(8) **MANHOLES.** (a) *Diameter.* The minimum diameter of manholes shall be 42 inches. A manhole shall have a minimum access opening of 24 inches.

(b) *Materials.* Manholes shall be constructed of approved materials in accordance with ch. ILHR 84 and in accordance with the design provisions of NR 110.13.

**Note 1:** The provisions of NR 110.13 regarding the manhole's flow channel, watertightness, and drop pipe indicate the following specifications:

- The flow channel through manholes shall be made to conform to the shape and slope of the sewer. See Appendix for further explanatory material.

- Solid watertight manhole covers are to be used wherever the manhole tops may be flooded by street runoff or high water. Where groundwater conditions are unfavorable, manholes of brick or block shall be waterproofed on the exterior with plastic coatings supplemented by a bituminous waterproof coating or other approved coatings. Inlet and outlet pipes are to be joined to the manhole with a gasketed flexible watertight connection or any watertight connection arrangement that allows differential settlement of the pipe and manhole wall to take place.

- An outside drop pipe is to be provided for a sewer entering a manhole where the invert elevation of the entering sewer is 2 feet or more above the spring line of the outgoing sewer. The entire drop connection shall be encased in the concrete. Inside drop connection may be approved on a case-by-case basis.

**Note:** See Appendix for further explanatory material.

**History:** Cr. Register, February, 1985, No. 350, eff. 3-1-85.

**ILHR 82.36 Storm and clear water drain systems.** (1) **SCOPE.** The provisions of this section set forth the requirements for the design and installation of storm and clear water drain systems including storm building drains and sewers.

(2) **MATERIALS.** All storm and clear water drain systems shall be constructed of approved materials in accordance with ch. ILHR 84.

(3) **DISPOSAL.** (a) *Storm sewer.* Storm water, surface water, groundwater and clear water wastes shall be drained to a storm sewer where available.

(b) *Other disposal methods.* 1. Where no storm sewer system is available or exists or is not adequate to receive the anticipated load, the storm water, surface water, groundwater and clear water wastes shall be discharged in accordance with local governmental requirements.

2. Where approved by the local governmental authority, storm water, surface water, groundwater and clear water wastes of the properties of one- and 2-family dwellings may be discharged onto flat areas, such as streets or lawns, so long as the water flows away from the buildings and does not create a nuisance.

(c) *Segregation of wastes.* 1. Storm and clear water wastes shall not discharge to any part of a sanitary drain system, nor shall sanitary wastes discharge to any part of a storm or clear water drain system; except the clear water wastes of a refrigerated drinking fountain, water heater relief valve or water softener may discharge to a sanitary drain system.

2. Storm water wastes and clear water wastes shall not be combined until discharging into the storm building drain.

(4) **LOAD ON DRAIN PIPING.** (a) *Storm water drainage.* The load factor on storm water drain piping shall be computed in terms of gallons per minute or on the square footage of the horizontal projection of roofs, paved areas, yards and other tributary areas.

(b) *Continuous flow devices.* Where there is a continuous or semicontinuous discharge into the storm building drain or storm building sewer, as from a pump, air conditioning unit, or similar device, each gallon per minute of such discharge shall be computed as being equivalent to 26 square feet of roof area.

(5) **SELECTING SIZE OF STORM AND CLEAR WATER DRAIN PIPING.** (a) *Horizontal storm water drain piping.* The pipe size for horizontal drain piping for storm water shall be determined from Tables 82.36-1 to 82.36-4.

**Table 82.36-1**  
**MINIMUM SIZE OF STORM WATER HORIZONTAL DRAIN PIPING**  
**SERVING ROOF AREAS**

Pipe Diameters (in inches)	Maximum Roof Areas (in square feet)			
	Pitch of Piping Per Foot			
	1/16 inch	1/8 inch	1/4 inch	1/2 inch
3	650	910	1,300	1,820
4	1,300	1,950	2,990	3,770
5	2,470	3,640	5,070	7,020
6	4,160	5,980	8,320	11,700
8	9,320	13,000	18,200	26,000
10	17,680	24,700	33,800	50,440
12	27,300	41,080	57,200	81,900
15	52,000	72,800	105,300	146,640
18	85,800	121,550	174,200	247,000
21	156,520	179,660	256,880	374,400
24	187,200	261,560	382,200	546,000

Note: Divide square footage by 26 to obtain flow in gpm.

**Table 82.36-2**  
**MINIMUM SIZE OF STORM WATER HORIZONTAL DRAIN PIPING SERVING**  
**PAVED OR GRAVELED GROUND SURFACE AREAS**

Pipe Diameters (in inches)	Maximum Surface Areas (in square feet)			
	Pitch of Piping Per Foot			
	1/16 inch	1/8 inch	1/4 inch	1/2 inch
3	810	1,140	1,625	2,270
4	1,625	2,430	3,740	4,720
5	3,090	4,550	6,350	8,760
6	5,200	7,470	10,400	14,600
8	11,650	16,250	22,750	32,600
10	22,100	30,850	44,250	63,000
12	34,150	52,300	71,500	102,200
15	65,000	91,000	131,500	183,000
18	107,000	152,000	210,800	321,000
21	195,000	224,000	321,000	468,000
24	234,000	336,000	478,000	682,000

Note: Divide square footage by 32.5 to obtain flow in gpm.

Table 82.36-3

**MINIMUM SIZE OF STORM WATER HORIZONTAL DRAIN PIPING SERVING  
LAWNS, PARKS AND SIMILAR LAND SURFACES**

Pipe Diameters (in inches)	Maximum Surface Areas (in square feet)			
	Pitch of Piping Per Foot			
	1/16 inch	1/8 inch	1/4 inch	1/2 inch
3	2,600	3,640	5,200	7,280
4	5,200	7,800	11,960	15,080
5	9,880	13,560	20,280	28,080
6	16,640	23,320	33,280	46,800
8	37,280	52,000	72,800	112,000
10	69,720	98,800	135,200	201,760
12	109,200	164,320	228,800	327,600
15	208,000	291,200	421,200	586,560
18	343,200	490,200	596,800	988,000
21	626,080	718,640	1,027,520	1,497,600
24	748,800	1,046,240	1,528,800	2,184,000

Note: Divide square footage by 104 to obtain flow in gpm.

Table 82.36-4

**MAXIMUM CAPACITY OF STORM WATER  
HORIZONTAL DRAIN PIPING FLOWING FULL**

Pipe Diameters (in inches)	Maximum Capacities in Gallons Per Minute			
	Pitch of Piping Per Foot			
	1/16 inch	1/8 inch	1/4 inch	1/2 inch
3	25	35	50	70
4	50	75	115	145
5	97	140	195	270
6	160	230	320	450
8	355	500	700	1,000
10	680	950	1,300	1,940
12	1,050	1,580	2,200	3,150
15	2,000	2,800	4,050	5,640
18	3,300	4,675	6,700	9,500
21	6,020	6,910	9,880	14,400
24	7,200	10,060	14,700	21,000

(b) *Vertical conductors for storm water.* 1. A vertical conductor for storm water shall not be smaller than the largest horizontal branch connected thereto.

2. Vertical conductors shall be sized in accordance with Table 82.36-5 or the diameter D, where

$$D = 1.128 \sqrt{\frac{A}{X}}$$

Where, A = the area of the roof in square feet

X = 300 square feet per square inch for a roof covered with gravel or slag and with a pitch not exceeding 1/4 inch per foot; or

= 250 square feet per square inch for a roof covered with gravel or slag and with a pitch of greater than 1/4 inch per foot; or

= 200 square feet per square inch for a roof with a metal, tile, brick or slate covering and of any pitch.

**Table 82.36-5**  
**MINIMUM DIAMETER OF VERTICAL CONDUCTORS**

Type of Roof	Maximum Roof Areas (in square feet)					
	Pipe Diameters (in inches)					
	2½	3	4	5	6	8
Roofs covered with gravel, slag, or similar material and with a pitch of ¼" per foot or less.	1,645	2,120	3,780	5,885	8,490	15,125
Roofs covered with gravel, slag or similar material and with a pitch greater than ¼" per foot.	1,220	1,770	3,150	4,905	7,075	12,600
Roofs covered with metal, tile, brick, slate or similar material and of any pitch.	975	1,415	2,520	3,925	5,660	10,080

Note: Divide square footage by 26 to obtain flow in gpm.

(c) *Clear water drain piping.* Drain piping for clear water shall be sized in accordance with ss. ILHR 82.30 (3) and (4).

(d) *Minimum size of underground drain piping.* Any portion of a storm or clear water drain system installed underground shall not be less than 2 inches in diameter. Underground drain piping which is 2 inches in diameter shall not exceed a length of 20 feet.

(e) *Minimum size of storm building sewers.* The pipe size for storm building sewers shall be determined from Tables 82.36-1 to 82.36-4. Storm building sewers serving combined storm water and clear water wastes shall be sized in accordance with Table 82.36-4.

1. Gravity flow sewers. a. The minimum size of a gravity flow storm building sewer shall be 3 inches in diameter between the building and lot line and 4 inches in diameter between the lot line and public sewer or private interceptor main sewer. A municipality or sanitary district by ordinance may require that portion of the storm building sewer between the lot line and public sewer or private interceptor sewer to be larger than 4 inches in diameter.

b. A gravity flow storm building sewer shall not be smaller than any storm building drain connected thereto, except a decrease in diameter in the direction of flow will be permitted if the increase in slope is sufficient to maintain the volume rate of flow. A reduction in diameter for the storm building sewer shall be made in a manhole.

2. Pressurized or forced sewers. Pressurized storm building sewers shall be not less than 1¼ inches in diameter.

(6) **PITCH OF HORIZONTAL DRAIN PIPING.** All horizontal drain piping shall be installed at a pitch which will produce a computed velocity of at least one foot per second when flowing full.

(a) *Storm water drain piping.* The minimum pitch of horizontal drain piping shall be in accordance with Tables 82.36-1 to 82.36-4.

(b) *Clear water drain piping.* The minimum pitch of horizontal clear water drain piping less than 3 inches in diameter shall be 1/8 inch per foot. The minimum pitch of horizontal drain piping 3 inches or larger in diameter shall be 1/16 inch per foot.

(7) **CHANGES IN DIRECTION OF FLOW.** Changes in direction of flow for storm and clear water drain piping shall be in accordance with s. ILHR 82.30 (8).

(8) **DRAINAGE FITTINGS AND CONNECTIONS.** Drain piping fittings and connections shall be in accordance with s. ILHR 82.30 (9).

(9) **STACK OFFSETS.** Stack offsets in clear water drain piping shall comply with s. ILHR 82.30 (6).

(10) **FLXTURE BRANCH CONNECTIONS NEAR BASE OF STACK.** Branch drains from interior clear water inlets shall not connect downstream from the base fitting or fittings of a drain stack or conductor within the distance equal to 20 pipe diameters of the building drain.

(11) **SUMPS AND PUMPS.** (a) *Sumps.* 1. General. All storm building sub-drains shall discharge into a sump, the contents of which shall be automatically lifted and discharged into the storm drain system.

2. Construction and installation. The sump shall have a rim extending at least one inch above the floor immediately adjacent to the sump, except where the sump is installed in an exterior meter pit. The sump shall have a removable cover of sufficient strength for anticipated loads. The sump shall have a solid bottom.

3. Location. All sumps installed for the purpose of receiving clear water, basement or foundation drainage water shall be located at least 15 feet from any water well.

4. Size. The size of each clear water sump shall be as recommended by the sump pump manufacturer, but shall be not smaller than 18 inches in diameter and 24 inches in depth.

(b) *Sump pump systems.* 1. Pump size. The pump shall have a capacity appropriate for anticipated use.

2. Discharge piping. Where a sump discharges into a storm building drain or sewer, a free flow check valve shall be installed.

(12) **SUBSOIL DRAINS.** Where a subsoil drain for a building is subject to backwater, it shall be protected by an accessible backwater valve or a sump with pump. Subsoil drains may discharge into an area drain, drain tile receiver or a sump with pump.

(13) **STORM BUILDING DRAINS AND SEWERS.** The interior plumbing of each building shall be entirely separated and independent of any other building's plumbing. All storm drain systems shall be connected by means of independent connections with a public sewer or private inter-

ceptor main sewer. No storm building sewer may pass under or through a building to serve another building.

(a) *Extensions to grade.* 1. The connection of a storm water leader discharging to a storm building drain or storm building sewer shall be made above the finished grade. That portion of the piping from the leader to at least one foot below grade shall be of cast iron.

2. The diameter of the drain piping connecting a storm water leader to a storm building drain or sewer shall be in accordance with sub. (5).

(b) *Other requirements.* 1. The elevation of storm building drains shall comply with s. ILHR 82.30 (11) (a) 1.

2. Storm building drains subject to backflow or backwater shall be protected in accordance with s. ILHR 82.30 (11) (a) 2.

3. The location of storm building drains and building sewers shall be in accordance with s. ILHR 82.30 (11) (c).

4. Storm building drains and building sewers shall be installed in accordance with s. ILHR 82.30 (11) (d).

5. Storm building sewers shall be connected to main sewers in accordance with s. ILHR 82.30 (11) (e).

(14) TRAPS FOR STORM AND CLEAR WATER BASES. (a) Traps shall be required for interior drain inlets receiving clear water wastes.

(b) Traps shall not be required for roof drains or exterior area drains for storm water waste, unless the drain inlet is located within 10 feet of an air inlet, door or openable window. Where a trap is required, the trap may be located inside the building. More than one drain inlet may discharge to the same trap.

(c) Where a subsoil drain discharges by gravity to a storm sewer the drain shall be trapped. Such a trap shall be provided with a cleanout.

(15) VENTS. (a) A trap receiving clear water wastes shall be vented in accordance with s. ILHR 82.31. Vent piping for a clear water drain system shall not be connected to a vent system serving a sanitary drain system or chemical waste system.

(b) Vents shall not be required for traps which receive only storm water or groundwater wastes.

(16) INTERIOR DRAIN INLETS. Interior clear water drain inlets shall terminate at least one inch above the finished floor.

(17) AREA DRAIN INLETS. (a) *Drain inlet design and construction.* 1. General. Storm water area drain inlets shall be constructed in a watertight and substantial manner of approved materials in accordance with ch. ILHR 84.

2. Inlet base. All site-constructed storm water area drain inlets subject to vehicular traffic shall be set on a 6 inch thick air-entrained concrete base with a minimum estimated compressive strength at 28 days of 3000 psi or on an approved precast concrete base.

3. Size. The size of masonry or concrete inlet basins shall be in accordance with subpars. a. and b.



a. Inlet basins 36 inches or less in depth shall have a minimum inside diameter of 24 inches. Basins shall be provided with an open bar grate not less than 18 inches in diameter.

b. Inlet basins with a depth greater than 36 inches shall have a minimum inside diameter of 36 inches. Basins shall be provided with an open bar grate not less than 24 inches in diameter.

4. Inlet grates. All inlets shall have an approved, well fitted, removable cast iron or steel grate of a thickness and strength to sustain anticipated loads. The grate shall have an available inlet area equal to or greater than the required waste outlet of the inlet.

Note: See Appendix for further explanatory material.

(b) *Subsurface areas of 50 square feet or less.* All subsurface areas, exposed to the weather, other than stairwells, with areas not exceeding 50 square feet shall be drained. These areas may drain to subsoil drains through a minimum 2 inch diameter pipe or a continuous layer of gravel or may drain to the storm building drain, storm subdrain, or storm sewer through a minimum 3 inch diameter pipe.

(c) *Subsurface areas of more than 50 square feet and stairwells.* An area drain shall be provided in subsurface areas, greater than 50 square feet in area, and all stairwells which are exposed to the weather. These areas shall be drained to the storm building drain, storm subdrain or storm sewer. If no storm sewer exists, the discharge shall be in accordance with sub. (3) (b). The fixture drain shall have a minimum inside diameter of 3 inches and shall not discharge into a subsoil, footing or foundation drain.

(18) **ROOF DRAINS.** (a) *General roofs.* Roof drains shall be equipped with strainers extending not less than 4 inches above the surface of the roof immediately adjacent to the roof drain. Strainers shall have an available inlet area above the roof of not less than 1½ times the area of the conductor to which the drain connects.

(b) *Flat decks.* Roof drain strainers for use on sun decks, parking decks and similar areas may be of the flat surface type level with the deck, and shall have an available inlet area of not less than twice the area of the conductor to which the drain connects.

(19) **CONTROLLED FLOW ROOF DRAIN SYSTEMS.** (a) *Application.* In lieu of sizing the roof storm drain piping on the basis of actual maximum horizontal projected roof areas as specified in sub. (4), the roof drain piping may be sized based on the equivalent adjusted maximum horizontal projected roof areas which result from controlled flow and storage of storm water on the roof.

Note: See s. Ind 53.11 (4) (d) as to provisions relating to the structural design of the roof for controlled flow drain systems.

(b) *Installation.* Control of storm water runoff shall be by control devices. Control devices shall be protected by strainers.

(c) *Sizing.* Not less than 2 drains shall be installed in roof areas 10,000 square feet or less and at least 4 drains in roofs over 10,000 square feet in area.

History: Cr. Register, February, 1985, No. 350, eff. 3-1-85.

## Subchapter IV Water Supply Systems

**ILHR 82.40 Water distribution systems. (1) GENERAL REQUIREMENTS.** Every building equipped with plumbing fixtures and used for human occupancy or habitation shall be provided with a potable supply of cold water. No water service shall pass under or through a building to serve another building. In residences and buildings serving the public and places of employment, hot water shall be provided.

(2) **WATER SERVICE.** (a) *Size.* The minimum inside diameter of a water service pipe shall be  $\frac{3}{4}$ -inch. The minimum size water service pipe may be increased by the local government or the utility by published ordinance or rule approved by the department. The size of the water service shall be determined by the requirements of sub. (4) (b) or (c). When sub. (4) (c) is used, the minimum pressures specified in sub. (4) (c) 1. g., shall be included in the calculations.

(b) *Materials.* The water service systems shall be constructed of approved materials in accordance with ch. ILHR 84. Any materials used within bounds of, or beneath an area subject to easement for highway or street purposes or public service right-of-ways, shall be subject to acceptance by the local government or the utility by published ordinance or rule approved by the department.

(c) *Valve controls.* Water service controls shall include a corporation cock or valve at the main, a curb stop at or near the property line and inside the wall of each building and on the water distribution side of the water meter.

Note: The water service terminates at the meter valve or within 3 feet where the pipe penetrates the building floor or wall.

1. The corporation cock or valve at the main shall be a ground key stop-cock. An approved gate valve may be used for services 3 inches or larger.

2. The curb stop shall be an approved gate valve, ground key stop-cock or a ball valve which shall be installed between the curb and the property line. When a private water supply serves more than one building a curb stop is required for each building. For a water service 3 inches or larger, one valve may serve as the shut off at the main and for the curb stop. See following sketch.

D.H.R. 82

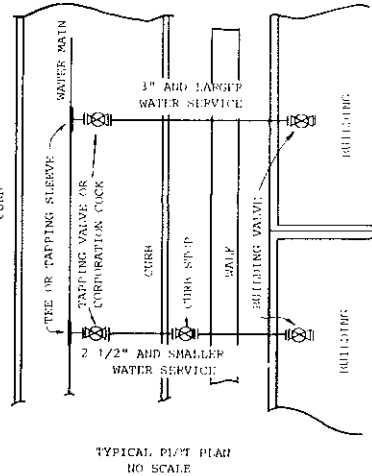
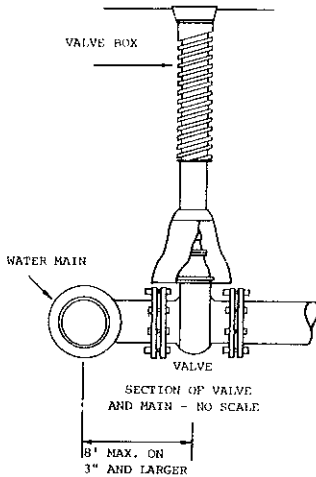

3. Building and meter valves. An approved valve shall be provided at the meter or at a point not more than 3 feet inside where the service penetrates the building floor or wall and another on the water distribution side of the meter. A valved bypass shall be provided for all 1½ inch or larger water meters. The bypass may be a minimum of one nominal pipe size smaller than the water service. When parallel meters are installed, a bypass may not be required provided the other meter(s) adequately serve the building water distribution requirements.

4. Prohibited valves. Combination stop and waste valves shall not be installed underground in water service piping. Frostproof yard hydrants shall be approved by the department.

(d) *Separation of water service and building sewers.* 1. Except as permitted below, the underground water service pipe and building sewer shall not be less than 8 feet apart horizontally and shall be separated by undisturbed or compacted earth. The water service pipe may be placed in the same trench with the building sewer under the following conditions:

- a. The water service and the building sewer are installed concurrently.
- b. The bottom of the water service pipe at all points shall be at least 12 inches above the top of the sewer line.
- c. The water service pipe shall be placed on the solid shelf excavated at one side of the common trench or the water service be installed at the side of the common trench with the 12 inches of bedding material meeting the following criteria. The initial backfill on the sides of the sewer pipe and to the 12-inch depth above the sewer shall be well tamped prior to installing the water service pipe. The bedding material shall be of medium to coarse sand, pea gravel or rock screenings.
- d. The number of joints in the water service pipe shall be kept to a minimum.

e. The water service shall be located a minimum of 10 feet from a septic tank or soil absorption site.

f. The materials and joints of water service pipe shall be installed in such a manner and shall possess the necessary strength and durability to prevent the escape of liquids and gases therefrom under adverse conditions such as corrosion, strain due to temperature changes, settlement, vibrations and superimposed loads.

2. Where the building sewer is existing, the water service pipe shall be installed in a separated trench pursuant to subd. 1., excepting a replaced water service may be installed pursuant to subd. 1. b. and c.

(3) **FIXTURE SUPPLY.** (a) *Potable water.* Only potable water shall be used in the processing of food, medical or pharmaceutical products, serving plumbing fixtures, appliances and appurtenances.

(b) *Identification.* Where 2 or more distribution systems are installed, each system shall be identified either by color marking, metal tags or other methods as may be approved by the department. All valves shall be tagged potable or nonpotable water.

1. *Color marking.* When color marking is used, potable water lines should be painted green and nonpotable water lines should be painted yellow. This requirement may be met by painting 3-inch wide bands at intervals of not more than 25 feet and at points where piping passes through walls, floors or roofs, in which case the bands shall be applied to the piping on both sides of the walls and both above and below the floor or roof. Points of outlets for nonpotable water shall be marked with a tag or color coded.

2. *Metal tags.* When tags are used, potable waterlines and valves shall be identified by 3-inch diameter metal tags bearing the legend SAFE WATER in letters not less than ½-inch in height. Nonpotable water lines and valves shall be identified by firmly attached metal tags having the shape of a 4-inch equilateral triangle bearing the legend WATER UNSAFE in letters not less than 7/16-inch in height. As in the use of color bands, tags shall be attached to pipes at intervals of not more than 25 feet and at either side of points where pipes pass through walls and above and below points where pipes pass through floors or roofs.

(4) **WATER SERVICE AND DISTRIBUTION DESIGN.** (a) *Design.* Water distribution piping systems shall be designed and installed so the maximum velocity through the piping shall not exceed 8 feet per second. Sizing of the water service and distribution system may be calculated and designed in accord with par. (b) or (c), whichever is applicable. Where street main pressures fluctuate, the water service, water meter and building distribution shall be designed for the minimum pressure available.

(b) *Sizing the water service and water distribution system by tables.* 1. *Limitations.* Where the total developed length of the water service is 75 feet or less and the total developed length of the water service and water distribution piping is 250 feet or less and the quantity of the water supply demand in total water supply fixture units, as determined from table 13 does not exceed the fixture units listed in tables 13a, 13b or 13c, the minimum size of the water service shall be determined from table 13a, 13b or 13c.

2. The following information is required. a. Pressures and elevations.

1) Maximum and minimum pressure at the water main or other supply source. The minimum pressure at the main is used for design purposes.

The maximum design pressure of the water distribution system is 80 p.s.i.g.

2) The difference in elevation between the street main or other source and the highest fixture or outlet and the pressure loss through any equipment such as a water conditioner, water meter, water heater, water filter, pressure regulator, pressure reducing valves, reduced pressure backflow preventer or similar devices.

b. Length. The total developed length of the piping from the water main or other source of supply to the furthestmost fixture.

c. Supply demand. The number of total water supply fixture units (s.f.u.) for all fixtures and other water uses as specified in table 13.

Note: See subd. 2. d., for sizing the water service and distribution when flush valves are installed.

d. Supply demand; Flush valves. Branches, mains and risers serving water closet or similar flush valves may be sized from table 13a, 13b or 13c, when the following values are assigned to each flushometer valve by beginning with the most remote valve on each branch.

First flushometer valve	40	fixture	units
Second " "	30	" "	" "
Third " "	20	" "	" "
Fourth " "	15	" "	" "
Fifth " "	10	" "	" "

Five fixture unit value flushometer valves may be computed at half the above values. After the fifth flushometer valve on any main, branch or riser, fixture loadings may be computed using the values given in table 13. No piping supplying a flushometer valve shall be less than the valve inlet.

3. Sizing the water service. a. Table selection. After determining the minimum water pressure at the source as specified in 2. a. 1), subtract  $\frac{1}{2}$  pound per square inch of pressure for each 1 foot of difference in elevation between the source and the highest fixture and any pressure loss through equipment as specified subd. 2. a. 2). Select table 13a, 13b or 13c with the pressure ranges that contain the calculated pressure.

b. Length column selection. Select the length column that is equal to or greater than the total developed length.

c. Size column selection. Follow down the column to a fixture unit value (s.f.u.) equal to or greater than the total number of fixture units required for the installation. The size of the water service will be found in the column labeled water service.

4. Sizing the water distribution system. Starting at the most remote fixture on the cold water supply and the hot water supply, apply the cold water or hot water fixture supply demand units as applicable from table 13 to the cold water or hot water supply adding the fixture units as additional fixtures are connected. Using table 13a, 13b or 13c, as selected in subd. 3. a., and the length column selected in subd. 3. b., select a horizontal line that meets or exceeds the fixture unit demand of that section of piping. Except for the minimum requirements in par. (c) 1. e., f. and table 15, the size of the water distribution main, water distribution branch, fixture supply branches and risers will be found in the column

labeled building distribution. The water distribution main serving water heaters and the cold water demand shall be sized to deliver the above required hot water demand, plus all required cold water demands but in no case need the piping be larger than that required for the total building supply as computed in subd. 4.

Table 13

## WATER SUPPLY FIXTURE DEMAND UNITS

Fixture	Occupancy	Type Control	Weight in Fixture Units		
			Hot	Cold	Total
Water Closet	Public	FL. Valve		10.	10.
Water Closet	Public	FL. Tank		5.	5.
Urinal	Public	½" FL. Valve		5.	5.
Urinal	Public	¾" FL. Valve		5.	5.
Lavatory	Public	Faucet	1.5	1.5	2.
Bath tub or Shower Head	Public	Faucet	3.	3.	4.
Service Sink	Offices, etc.	Faucet	2.25	2.25	3.
Kitchen Sink	Hotels-Restaurants	Faucet	3.	3.	4.
Drinking Fountain	Offices, etc.	¾ Valve		0.25	0.25
Water Closet	Private	FL. Valve		6.	6.
Water Closet	Private	FL. Tank		3.	3.
Lavatory	Private	Faucet	0.75	0.75	1.
Lavatory-Treatment or Clinical	Public	Faucet	1.	1.	1.5
Bath tub or Shower Head	Private	Mixing Valve	1.5	1.5	2.
Kitchen Sink	Private	Faucet	1.5	1.5	2.
Laundry Trays (1 to 3 compartments)	Private	Faucet	2.25	2.25	3.
Combination Fixture	Private	Faucet	2.25	2.25	3.
Dishwashing Machine	Private	Automatic	1.		1.
Emergency Eyewash	Public	Faucet		1.	1.
Laundry Machine (8 lb)	Private	Automatic	1.5	1.5	2.
Laundry Machine (8 lb)	Public or General	Automatic	2.25	2.25	3.
Laundry Machine (Large)	Refer to Manufacturer's Requirements				
Bathroom Group	Private	FL. Valve	2.25	8.25	9.
Bathroom Group	Private	FL. Tank	2.25	5.25	6.
Bidet	Public	Variable	3.00	3.00	4.
Coffee Urn Stand	Public	Variable		2.	2.
Food Waste Grinder	Public	Variable			
				Manufacturer's Requirements	
Hose-Pre-Rinse	Public	Variable	2.5	2.5	3.
Hose Station	Public	Variable	3.0	3.0	4.
Ice Maker	Public	Variable		1.	1.
Sink - Baker's Pan	Public	Variable	2.5	2.5	3.
Sink - Back Bar	Public	Variable	1.5	1.5	2.
Sink - Barber and Shampoo	Public	Faucet	1.5	1.5	2.
Sink - Cook's	Public	Variable	2.5	2.5	3.
Sink - Cup	Public	Variable		1.	1.
Sink - Diet Kitchen	Public	Variable	1.5	1.5	2.
Sink - Laboratory	Public	Variable	1.5	1.5	2.
Sink - Laboratory and Trough	Public	Variable	1.5	2.5	3.
Sink - Meat Preparation	Public	Variable	2.5	2.5	3.
Sink - Pot and Pan (Per Faucet)	Public	Variable	3.	3.	4.
Sink - Salad Preparation	Public	Variable	2.5	2.5	3.
Sink - Silver Soak	Public	Variable	2.5	2.5	3.
Sink - Treatment or Exam	Public	Variable	1.5	1.5	2.
Sink - Vegetable	Public	Variable	2.5	2.5	3.
Ice Cuber & Flakers	Public	Variable		1.	1.
Hosebibb - Wall Hydrant	Public and Private	Variable		4.	4.
Wall Hydrant C.W. & H.W.	Public and Private	Variable	3.	3.	4.
Wash Fountain - Factory	Public	Variable	1.5	1.5	2.
Wash-up (20" = 1 Lav Space)					

"Private" fixtures are those in residential areas not freely accessible, such as in private homes, residential apartments, hotel guest rooms, private rooms or apartments in residential hotels, dormitories or executive suites and the like.

**Table 13a**

**MAXIMUM FIXTURE UNITS (s.f.u.) WATER SERVICE AND DISTRIBUTION  
 SIZING CALCULATED PRESSURE RANGE 30 THROUGH 45 PSI**

Water Service Not to Exceed 75 Feet	Building Distribution	Maximum Total Developed Allowable Length In Feet				
		75	100	150	200	250
3/4"	3/4"	20	18	15	12	9
3/4"	1"	20	18	16	16	15
1"	1"	30	27	24	21	20
1"	1-1/4"	39	36	32	30	28
1-1/4"	1"	32	32	32	28	23
1-1/4"	1-1/4"	56	49	44	35	32
1-1/4"	1-1/2"	56	56	56	51	48
1-1/2"	1-1/4"	56	56	56	56	56
1-1/2"	1-1/2"	109	103	84	63	56
1-1/2"	2"	127	123	111	103	86
2"	1-1/2"	111	111	111	78	66
2"	2"	275	264	186	175	146

**Table 13b**

**MAXIMUM FIXTURE UNITS (s.f.u.) WATER SERVICE AND DISTRIBUTION  
 SIZING CALCULATED PRESSURE RANGE 46 THROUGH 60 PSI**

Water Service Not to Exceed 75 Feet	Building Distribution	Maximum Total Developed Allowable Length In Feet				
		75	100	150	200	250
3/4"	3/4"	20	18	18	18	16
3/4"	1"	30	28	26	24	22
1"	1"	34	34	34	34	30
1"	1-1/4"	58	56	54	49	46
1-1/4"	1"	34	34	34	34	34
1-1/4"	1-1/4"	58	58	58	58	54
1-1/4"	1-1/2"	111	95	86	78	69
1-1/2"	1-1/4"	58	58	58	58	58
1-1/2"	1-1/2"	111	111	111	111	99
1-1/2"	2"	225	220	196	175	170
2"	1-1/2"	111	111	111	111	111
2"	2"	275	275	275	275	250



Table 13c

**MAXIMUM FIXTURE UNITS (s.f.u.) WATER SERVICE AND DISTRIBUTION  
SIZING CALCULATED PRESSURE RANGE OVER 60 PSI  
(but not to exceed 80 PSI)**

Water Service Not to Exceed 75 Feet	Building Distribution	Maximum Total Developed Allowable Length In Feet				
		75	100	150	200	250
3/4"	3/4"	20	18	18	18	18
3/4"	1"	34	32	30	28	26
1"	1"	34	34	34	34	34
1"	1-1/4"	58	58	58	58	54
1-1/4"	1"	34	34	34	34	34
1-1/4"	1-1/4"	58	58	58	58	58
1-1/4"	1-1/2"	111	111	111	111	98
1-1/2"	1-1/4"	58	58	58	58	58
1-1/2"	1-1/2"	111	111	111	111	111
1-1/2"	2"	275	275	250	235	215
2"	1-1/2"	111	111	111	111	111
2"	2"	275	275	275	275	275

(c) Friction loss method for sizing the water service and distribution system. 1. The supply demand in gallons per minute in the building water distribution system shall be determined on the basis of the load in terms of supply fixture units and of the relationship between load and supply demand as shown in tables 13 and 14. Water supply outlets for items not listed in table 13 shall be computed at their maximum demand but in no case less than:

FIXTURE	NUMBER OF FIXTURE UNITS	
	PRIVATE USE	PUBLIC USE
3/8-inch pipe	1	2
1/2-inch pipe	2	4
3/4-inch pipe	3	6
1 inch pipe	6	10

a. For supply outlets likely to impose continuous demands, estimate continuous supply separately in gallons per minute and add to total demand in gallons per minute for fixtures.

b. The given weights in table 13 are for total demand and for fixtures with both hot and cold water supplies. The weights for maximum separate demands are taken as 1/2 the listed total demand for the hot water supply and the cold water supply.

c. Compute flush valve demand separately.

d. Demand (GPM) Corresponding to Fixture Load (WSFU). To determine the demand in gallons per minute corresponding to any given load in water supply fixture units, reference must be made to table 14, Table for Estimating Demand.

Table 14

## ESTIMATING DEMAND

Supply Systems Predominantly For Flush Tanks		Supply Systems Predominantly For Flush Valves	
Load (Water Supply Fixture Units)	Demand GPM	Load (Water Supply Fixture Units)	Demand GPM
6	5		
8	6.5		
10	8		
12	9.2	10	27
14	10.4	12	28.6
16	11.6	14	30.2
18	12.8	16	31.8
20	14	18	33.4
25	17	20	35
30	20	25	38
35	22.5	30	41
40	24.8	35	43.8
45	27	40	46.5
50	29	45	49
60	32	50	51.5
70	35	60	55
80	38	70	58.5
90	41	80	62
100	43.5	90	64.8
120	48	100	67.5
140	52.5	120	72.5
160	57	140	77.5
180	61	160	82.5
200	65	180	87
225	70	200	91.5
250	75	225	97
275	80	250	101
300	85	275	105.5
400	105	300	110
500	125	400	126
750	170	500	142
1,000	208	750	178
1,250	240	1,000	208
1,500	267	1,250	240
1,750	294	1,500	267
2,000	321	1,750	294
2,250	348	2,000	321
2,500	375	2,250	348
2,750	402	2,500	375
3,000	432	2,750	402
4,000	525	3,000	432
5,000	593	4,000	525
6,000	643	5,000	593
7,000	685	6,000	643
8,000	718	7,000	685
9,000	745	8,000	718
10,000	769	9,000	745
		10,000	769

e. Size. The diameter of any pipe serving more than one plumbing fixture or appliance shall not be less than  $\frac{3}{4}$ -inch inside diameter.

f. Minimum size. The minimum size of a water distribution branch serving no more than one fixture shall be as shown in table 15. The water distribution branch shall be extended to within at least 18 inches of the point of connection to the fixture.

**Table 15**  
**MINIMUM SIZES OF WATER DISTRIBUTION BRANCHES**

Type of Fixture or device	I.D. Pipe Size (Inches)	Type of Fixture or device	I.D. Pipe Size (Inches)
Bathtubs	1/2	Shower (single head)	1/2
Combination sink and tray	1/2	Sinks (service, mop)	1/2
Drinking fountain	3/8 (1' max)	Sinks (flushing rim)	3/4
Dishwasher (domestic)	1/2	Urinal (direct flush valve)	3/4
Electric drinking water cooler	3/8 (1' max)	Urinal (direct flush valve)	1/2 (1' max)
Kitchen sink, residential	1/2	Water closet (tank type)	3/8 (1' max)
Kitchen sink, commercial	3/4	Water closet (flush valve type)	1 (1' max)
Lavatory	3/8 (1' max)	Hose bibb	1/2
Laundry tray 1, 2 or 3 compartments	1/2	Wall hydrant	1/2

g. Minimum hydrostatic pressure. Based on the minimum hydrostatic pressure available, pipe sizes shall be selected so that under conditions of peak demand a minimum flow pressure at the point of discharge shall be not less than required to maintain minimum flow rates listed in table 16. Pipe sizes for flush valve water closets and urinals shall be adequate to maintain flow pressures of 20 pounds per square inch for blowout action and jet action fixtures. For fixtures other than those supplied by flush valves, a minimum pressure of 8 pounds per square inch at the highest fixture shall be included in the calculations.

**Table 16**  
**MINIMUM AND MAXIMUM FLOW RATES TO FIXTURES AND APPURTENANCES**

Fixture	Flow Rate Minimum GPM	Flow Rate Maximum GPM
Lavatory - Residential		3
Lavatory - Public		1 after handle release
Sink	4	4
Bathtub	6	
Laundry tray	5	
Shower except for safety - each head		3
Water closets		
Tank type		4 gal. per flush
Blowout action		4 gal. per flush
Jet action		4 gal. per flush
Drinking fountain	0.75	
Wall hydrant	5	
Urinal		1.5 gal. per flush

h. Variable street pressures. Where street water main pressures fluctuate, the building water distribution system shall be designed for the minimum pressure available.

i. Location and size of water supply source. Location and size of the public water main, where available, should be obtained from the local water authority.

j. Elevations. The relative elevations of the source of water supply and the highest water supply outlets in the building must be determined. In the case of a public main, the elevation of the point where the water service connection is to be made to the public main must be obtained from the local water authority.

k. Maximum total developed length of system. Information shall be obtained regarding the total developed length of the water service piping from the source of water supply to the water service control valve of the building. Determine the total developed length of the distribution piping from the service control valve to the highest and most remote water outlet on the system.

l. Friction loss. Calculate the permissible uniform pressure loss for friction in the system. The amount of pressure available for dissipation as friction loss due to pipe, fittings, valves and appurtenances or devices in the system, must be divided by the maximum total developed length of the water service and water distribution system. This establishes the pipe friction limit for the circuit or system in terms of pressure loss, in psi, per foot of total pipe length. Multiply this value by 100 in order to express the pipe friction unit in terms of psi per 100 feet of length. If specifications for pressure loss due to fittings and valves are not furnished, add 50% of the maximum total developed length for friction loss.

m. Size all parts of the basic design circuit or system, and all other main lines in accordance with tables 16a, 16b, 16c, 16d or 16e. The table selected shall correspond with the type of material approved for the water service, water distribution or both.

Table 16a

PRESSURE LOSS DUE TO FRICTION—  
 COPPER WATER TUBE, TYPE K (ASTM B88)  
 Surface Condition: "Fairly Smooth"  
 $q = 4.57 p^{0.546} d^{2.64}$

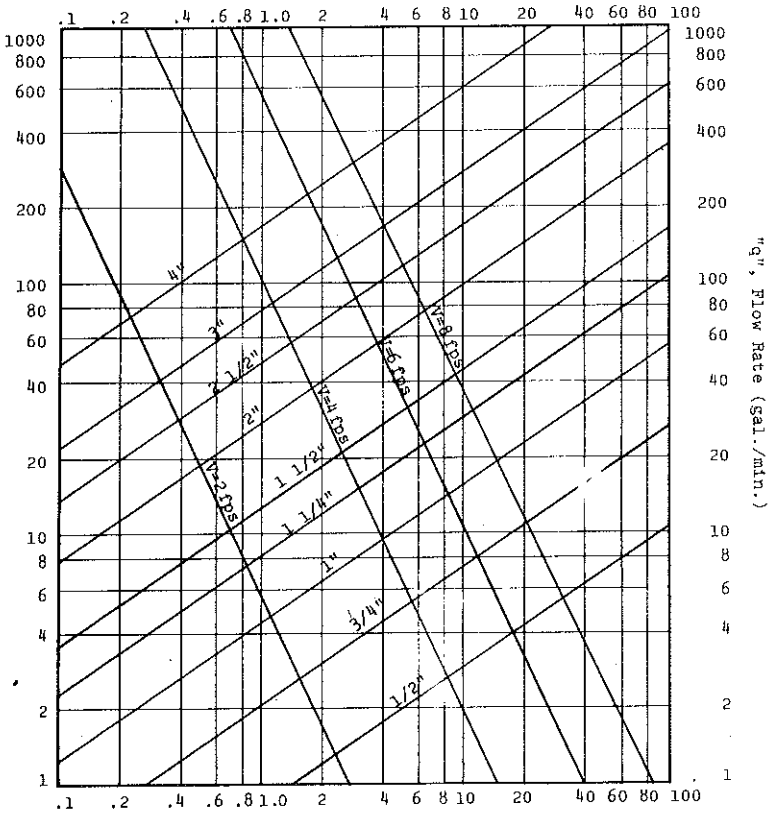

"p", Pressure Loss Due To Friction (psi/100 ft. of pipe)

Table 16b

PRESSURE LOSS DUE TO FRICTION—  
 COPPER WATER TUBE, TYPE L (ASTM B88)  
 Surface Condition: "Fairly Smooth"  
 $q = 4.57 p^{0.526} d^{2.64}$

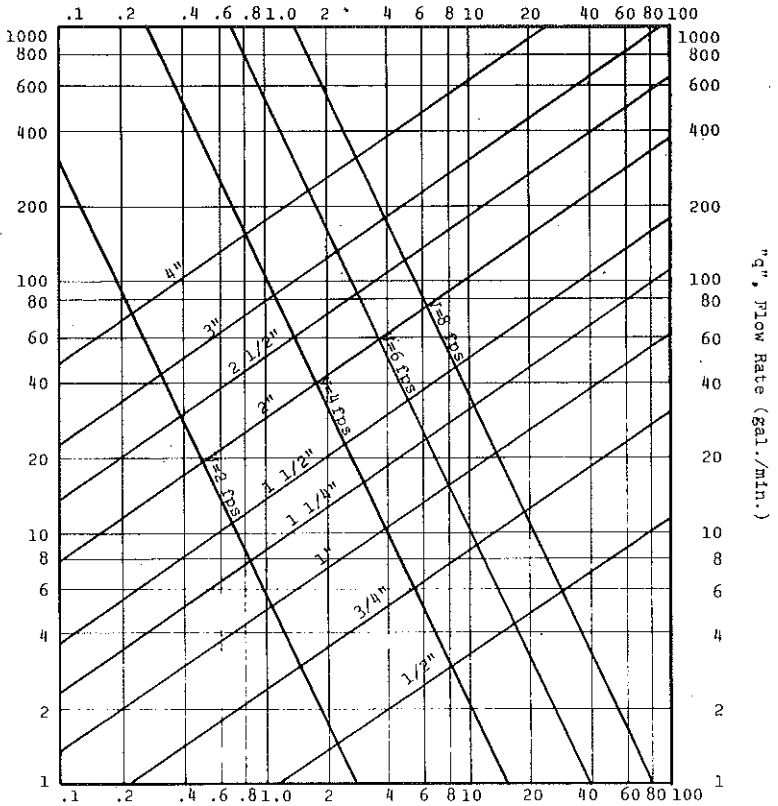

"p", Pressure Loss Due To Friction (psi/100 ft. of pipe)

Table 16c

PRESSURE LOSS DUE TO FRICTION—  
 COPPER WATER TUBE, TYPE M (ASTM B88)  
 Surface Condition: "Fairly Smooth"  
 $q = 4.57 p^{0.546} d^{2.64}$

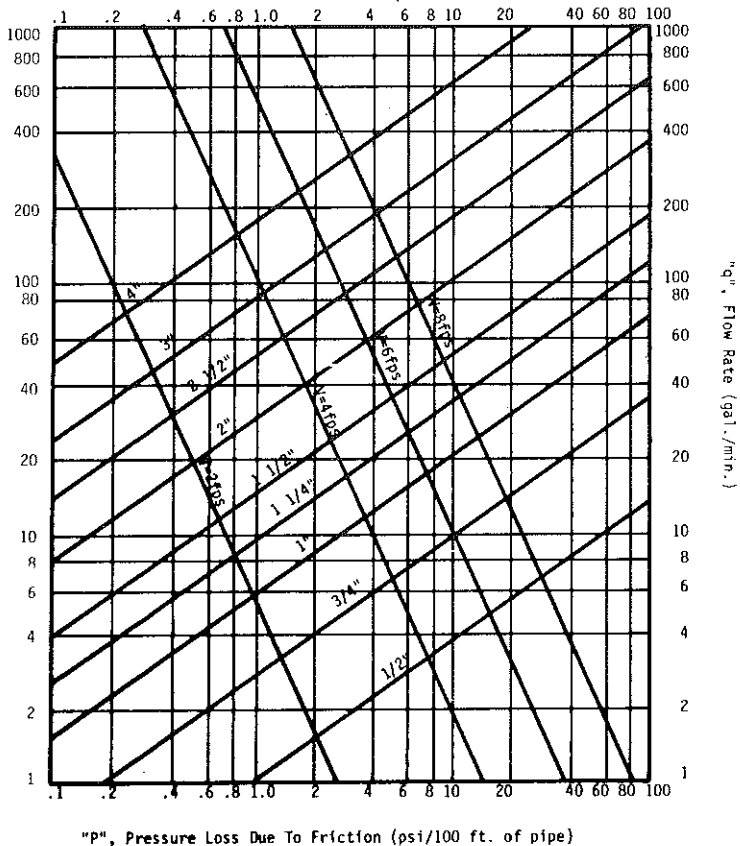

"p", Pressure Loss Due To Friction (psi/100 ft. of pipe)

**Table 16d**  
**PRESSURE LOSS DUE TO FRICTION—**  
**GALV. IRON & STEEL STANDARD WEIGHT PIPE**  
**(ASTM A72, A120)**  
**Surface Condition: "Fairly Rough"**  
 $q = 4.29 p^{0.521} d^{2.562}$

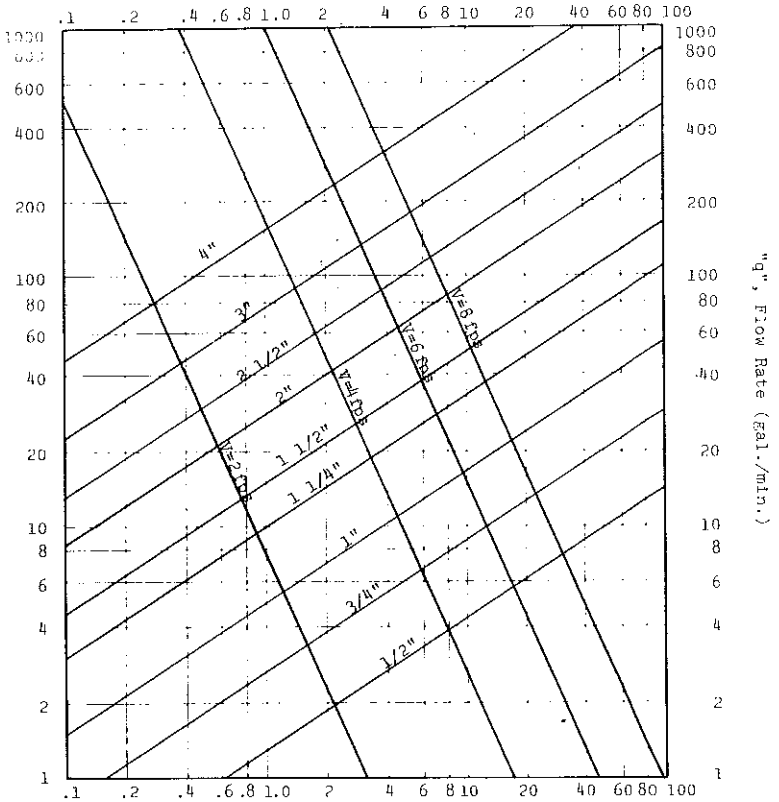

"p", Pressure Loss Due To Friction (psi/100 ft. of pipe)



Table 16e

FLOW DATA FOR THERMOPLASTIC PIPE  
SCHEDULE 40

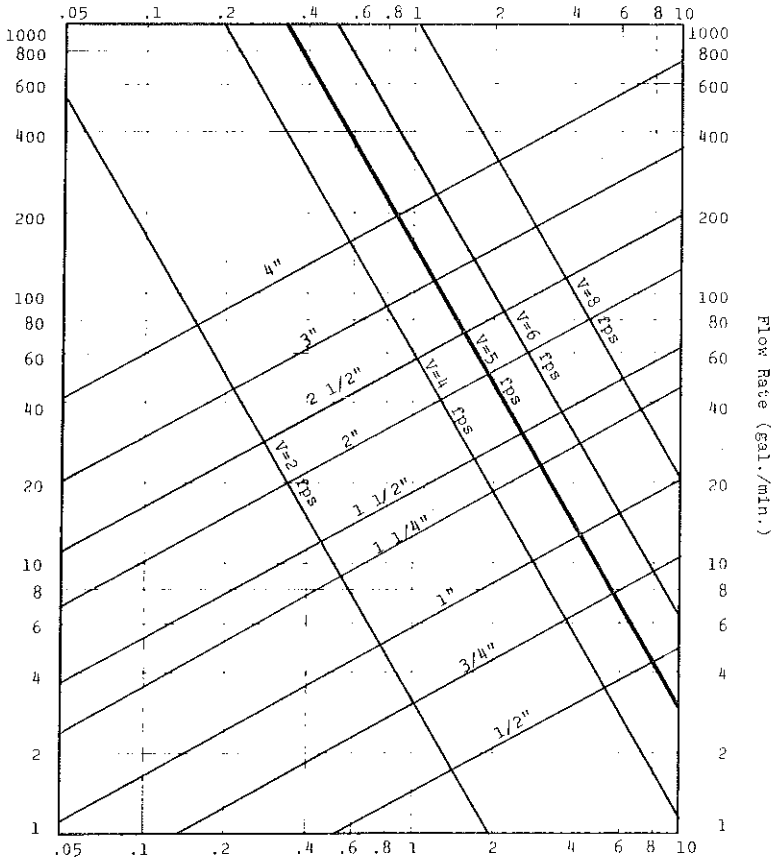

“p”, Pressure Loss Due To Friction (psi/100 ft. of pipe)

n. Hot water distribution. In residences, buildings serving the public and places of employment, hot water shall be supplied to all plumbing fixtures and equipment used for personal hygiene, bathing, washing, culinary purposes, cleansing, laundry or building maintenance.

2. Excessive pressures. Water pressure at any fixture, appliance or appurtenance shall not exceed 80 psi for a period not to exceed 60 minutes in any 24-hour period under no flow conditions. When the water pressure in a part of or the entire water distribution system serving a fixture(s), appliance(s), or appurtenance(s) exceeds 80 psi for a period of more than 60 consecutive minutes, an approved type pressure reducing valve, preceded by a strainer, shall be installed and the pressure reduced to 80 psi or less for that part or all of the system that serves a fixture(s), appliance(s) or an appurtenance(s). Outside wall hydrants, sill cocks, water supply directly to a water pressure booster system, elevated water gravity tank or to pumps provided in connection with a hydropneumatic or elevated gravity water supply system may be left at full pressure.

3. Design methods. The methods utilized in designing and sizing the water distribution system may vary and recognized engineering practices meeting the criteria established in this section shall be acceptable. Plans and specifications submitted to the department for plan examination shall include all calculations and data relating to the sizing of the water distribution system.

(d) *Materials and installation.* 1. Materials. Water distribution systems shall be constructed of approved materials in accordance with ch. ILHR 84.

2. Frost protection. All water pipe, storage tanks, fixtures, appliances and appurtenances subject to low temperatures shall be, so far as practical, effectively protected against freezing.

3. Bending of pipe. Bending of water distribution piping except fixture supply tubing is prohibited.

(e) *Supports.* All piping shall be supported to prevent undue strains upon connections or fixtures and shall be so aligned and graded that the entire system or parts thereof can be controlled and drained. The formation of traps or sags in water piping shall be avoided where possible. When unavoidable such sags, traps or inverts shall have provisions for properly draining same.

(f) *Water temperature control — public buildings.* Temperature of mixed water to multiple or gang showers shall be controlled by a master thermostatic blender or such showers may be individually regulated by pressure balance mixing valves. Individual showers in commercial and public buildings shall have pressure balance mixing valves in addition to flow regulation as indicated in table 16.

1. Return circulation where required. Hot water supply risers in buildings 5 or more stories in height or in buildings where developed length of hot water piping from the source of the hot water supply to the farthest fixture exceeds 100 feet, shall be of the return circulation type and no uncirculated branch line shall exceed 25 feet in length. Valves shall be provided on the inlet and outlet of all circulating return lines and on the inlet and outlet of the return circulation pump.

2. Insulation - storage tanks. Heat loss from unfired hot water storage tanks shall be limited to 15 BTU per hour per square foot of external tank surface area. The design ambient temperature shall be no higher than 65°F.

3. Insulation - piping. Piping heat loss for recirculation systems shall be limited to a maximum of 25 BTU per hour per square foot of external pipe surface for aboveground piping and a maximum of 35 BTU per hour per square foot of external pipe surface for underground piping. Maximum heat loss shall be determined at a  $\Delta T$  equal to the maximum water temperature minus a design ambient temperature no higher than 65°F.

(g) *Water heaters and hot water storage tanks.* 1. General. All water heaters either for domestic or industrial use shall be of an approved type and shall connect to the water distribution system in an approved manner. All heaters except electric heaters shall be provided with a flue of rust resistant material connected to a chimney or gas vent stack. All water heaters shall be permanently marked with the rated input of the heater in B.T.U. or watts. Such marking shall be in an accessible position on the outside of the heater for inspection purposes.

2. Safety devices. All safety devices, except mixing valves, shall meet the current requirements of one or more of the following: American Gas Association, Underwriters Laboratories, Inc., American Society of Mechanical Engineers or National Board of Boiler and Pressure Vessel Inspectors. Test and certification by a laboratory in accordance with one of the above applicable standards shall also be considered acceptable. All water safety devices shall be of the temperature and pressure type installed in accordance with this code.

Note: The above standards are on file in the offices of the department of industry, labor and human relations, secretary of state, and revisor of statutes, and may also be obtained for personal use as follows:

1) Approval requirements for gas water heaters, volume 1, Seventeenth Edition, 1966.

Approval requirements for gas water heaters, volume II, effective January 1, 1968.

Approval requirements for gas water heaters, volume III, third edition, 1965. Listing requirements for relief valves and automatic gas shutoff devices for hot water supply systems, effective January 1, 1965 and addenda effective January 1, 1966.

The above standards are available from American Gas Association, Inc., 605 Third Avenue, New York, New York 10016.

2) Standards for safety, household electric storage-tank water heaters, UL 174, third edition, May 1, 1970, and revision pages dated June 16, 1971, January 18, 1971.

The above standards are available from:

Underwriters' Laboratories, Inc.  
207 E. Ohio Street, Chicago, IL 60611  
333 Pfingsten Road, Northbrook, IL 60062  
1655 Scott Boulevard, Santa Clara, CA 95050  
1285 Walt Whitman Road, Melville, L.I., NY 11746

3) ASME Boiler and Pressure Vessel Codes, Heating Boilers, section IV, 1971, available from American Society of Mechanical Engineers, 29 West 39th Street, New York, NY 10018.

4) Relieving capacities of safety valves and relief valves, January 1, 1970.

The above standards are available from The National Board of Boiler and Pressure Vessel Inspectors, 1155 North High Street, Columbus, OH 43201.

3. Tank construction. Storage tanks for direct fired storage type water heaters shall be constructed to withstand a minimum of 300 psi test pressure. Register, February, 1985, No. 350

sure without leakage or permanent distortion and shall bear the manufacturers' marking showing test and working pressure, except that in lieu thereof, pressure markings appearing on AGA or UL listed water heater units will be considered acceptable.

4. Hot water storage tank and heater drain valves. a. Location. A drain valve shall be installed at the lowest point of each hot water storage tank and be readily accessible.

b. The drain valve shall be hand-operable without the use of tools.

c. The drain valve inlet shall be a minimum  $\frac{3}{4}$ -inch nominal iron pipe size and the outlet end shall be equipped with a minimum standard  $\frac{3}{4}$ -inch hose thread.

5. Water heaters, storage tanks and boilers. a. Combination domestic water heating/space heating boilers. Space heating boilers shall not be used for service water heating from May 1 to September 30 unless the service water heating load equals or exceeds 30% of the net boiler load.

b. Temperature controls. Service water heating systems shall be equipped with automatic temperature controls capable of adjusting from the lowest to the highest acceptable temperature setting for the intended use.

c. Shut down. A separate means shall be provided to permit turning off the energy supplied to service water heating systems.

(h) *Relief valves.* 1. Pressure relief valves. Pressure relief valves shall meet the A.S.M.E. standards. The valves shall have a relief rating adequate to meet the pressure conditions in the equipment served. The relief valve shall be installed either directly in a top tank tapping or in the hot water outlet line close to the tank. In a tankless-type heater, the relief valve shall be installed in the hot water outlet line as close as possible to the unit. There shall be no shut-off valve between the pressure relief valve and the tank. The pressure relief valve must be set to open at not less than 25 p.s.i. above the street main pressure or not less than 25 p.s.i. above the setting of any building water pressure regulating valve. The setting shall not exceed the tank rated working pressure.

2. Temperature relief valves. Temperature relief valves shall be of adequate relief rating expressed in B.T.U./hr for the equipment served. They shall be installed so that the temperature sensing element is immersed within the top 6 inches of the tank. The valve shall be set to open when the stored water temperature is 210°F. (or less).

3. Combination pressure temperature relief valves. Combination pressure temperature relief valves shall comply with all the requirements of the separate pressure and temperature relief valves.

4. Energy cut-off devices. Energy cut-off devices shall be of adequate performance rating for the equipment served. Immersion type energy cut-off devices shall be located so that the temperature sensing element is immersed in the water within the tank and controls the temperature of the water within the top 6 inches of the tank. When approved by the department, contact types shall be installed so that the sensing element is responsive to the highest water temperature within the equipment served and is securely fastened in place. When an energy cut-off device is used, it shall be factory applied by the heater manufacturer and comply

fully with the appropriate standards of A.N.S.I. or U.L. They shall be installed in a manner that will isolate them from ambient flue gas temperatures and other conditions not indicative of the temperature of the water within the heater.

5. Installation of relief valve discharge. Every relief valve shall have a discharge pipe the same size as the outlet drain on the relief valve which shall terminate not more than 10 inches above the floor as close as possible to a drain properly connected to the building drain or sewer. Such discharge pipe shall be galvanized steel, copper or brass, installed with approved fittings. The relief valve discharge pipe shall be pointed and drained downward in such a manner to allow the drain and discharge pipe to drain dry. The base or end of such discharge pipe shall not be threaded. No discharge pipe shall terminate into an open fixture such as a sink, laundry tub, bathtub, bathtub overflow, urinal, fixture tailpiece or supply tank, etc., or installed in a freezing area. No check valve or shut-off valve shall be installed between any safety device and the hot water equipment used, nor shall there be any valve in the discharge pipe from the relief valve.

6. Vacuum relief valves. Where a hot water storage tank or direct or indirect water heater is located at an elevation of 20 feet from the bottom of the heater or more above the lowest fixture outlets in the hot water system, a vacuum relief valve shall be installed on the storage tank or heater.

7. Pressure marking of hot water storage tanks. Hot water storage tanks shall be permanently marked in an accessible place with the maximum allowable working pressure.

(i) *Water hammer suppressors.* 1. Water hammer suppressors. All water supply systems, water distribution systems and components connected thereto, subject to water hammer, shall be provided with approved shock absorbing devices located and sized to suppress water hammer. All appliances, devices, equipment, fixtures and appurtenances with quick closing valves or which may create water hammer, shall be provided with shock absorbing devices. When copper air chambers are used, the minimum size shall be  $\frac{1}{2}$ " x 1" x 14".

2. Mechanical suppressors. The size and location of the suppressors shall be in accord with the hydraulic design of the piping system served and to the manufacturer's recommendations. All mechanical water hammer suppressors shall be accessible.

Note: The water hammer suppressor may be eliminated provided the appliance, appurtenance, device, equipment or fixture has a slow closing or manually closed valve and does not create water hammer.

(j) *Water distribution control valves.* 1. Single family dwellings. Controls within a single family dwelling unit shall include a valve for each lawn sprinkler faucet, water heater, water closet, point of entrance of the water service, discharge side of the water meter and each appliance or appurtenance.

2. Multiple dwellings and public buildings. a. In all public buildings and multiple dwelling units, each hot and cold water distribution main, riser and branch main shall be valved. All fixtures, appliances, appurtenances, lawn sprinkler faucets and wall hydrants shall be valved. The

meter valve on the discharge side of the meter may serve as the water distribution main valve. See following sketch.

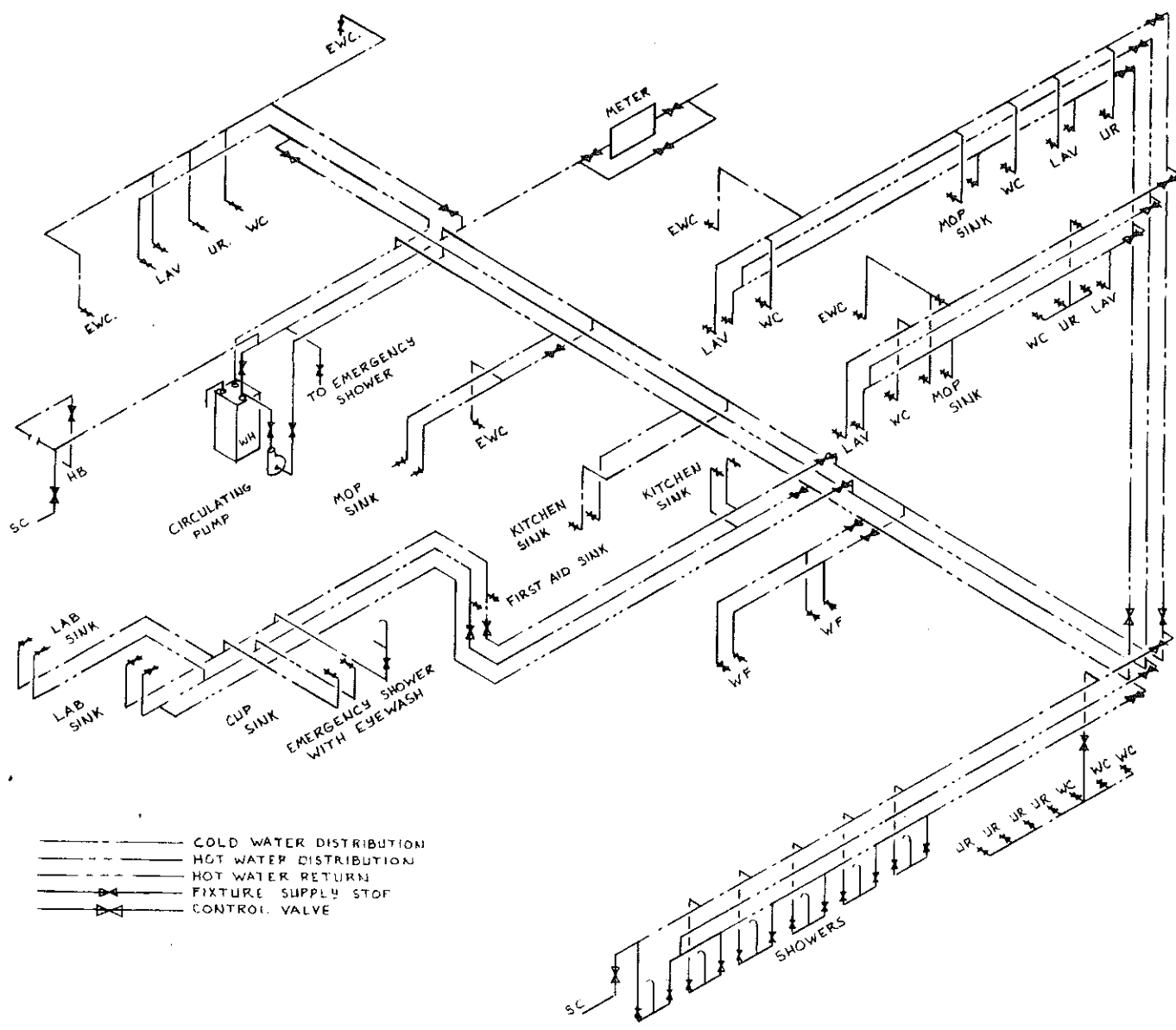

b. Riser valves. A valve shall be installed at the foot of each water supply riser or in the branch main serving a single riser. In buildings incorporating down feed risers a valve shall be installed at the top of each water supply down feed riser. See following sketch.

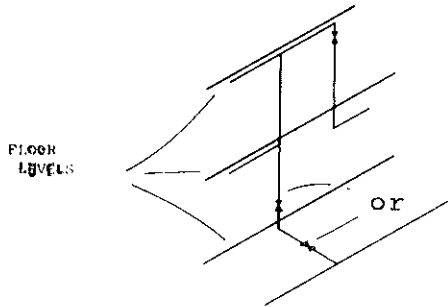

c. Water heating equipment valve. The cold water branch to each hot water storage tank or water heater shall be provided with a valve located in the same room near the equipment and serving only this equipment. Each tank or heater shall be equipped with an approved safety relief valve as specified in pars. (g) and (h).

d. Water conditioner bypass. All commercial water conditioners shall be provided with a valved bypass. The bypass may be a minimum of one nominal pipe size smaller than the water supply to the unit.

e. Valves location. All water supply control valves shall be placed so as to be accessible for service and maintenance.

f. Control valve design. Fixture supply valves shall have flow capacity, without reducing the pressure at the fixture to less than the minimum specified in this section, to provide the minimum flows as required in table 16. Line valves ¾-inch inside diameter and larger shall be the same size as the pipe being served and have a Cv factor not less than that specified in the following table for the particular pipe size.

I.D. Pipe Size	Minimum Cv Factor
¾	18
1	35.5
1-¼	61
1-½	107
2	175
3	255
4	340

Note: The Cv factor is defined as the flow coefficient for valves, expressing the flow rate in gallons per minute of 60° with a 1 psi pressure drop across the valve.

g. Tank controls. Supply lines from pressure or gravity tanks shall be valved in the same room at or near the tanks.

h. Valving requirements for hospitals and nursing homes shall comply with s. ILHR 82.50 (10) (b).



(5) **WATER PRESSURE BOOSTER SYSTEMS.** (a) *Where required.* When the water pressure in the public water main or individual water supply system is insufficient to supply the probable peak demand flow to all plumbing fixtures and other water needs freely and continuously within the minimum pressures and quantities specified in sub. (4) (c), tables 13, 14, 15 and 16; or elsewhere in this section and in accordance with good practice, the rate of supply shall be supplemented by an elevated water tank, a hydropneumatic pressure booster system, or a water pressure booster pump.

(b) *Overflows for water supply tanks.* Each gravity or unpressurized water supply tank shall be provided with an overflow having a diameter not less than shown in table 17. The overflow outlet shall discharge above and within 6 inches of a roof drain or site drain which terminates in a storm sewer. The overflow outlet shall be covered by a corrosion resistant screen of not less than 16 x 20 mesh to the inch and by ¼ inch hardware cloth or shall terminate in a horizontal angle seat check valve. Drainage from overflow pipes shall be directed so as not to freeze on roof walkways.

Table 17

SIZES FOR OVERFLOW PIPES FOR WATER SUPPLY TANKS

Maximum Capacity of Water Supply Line of Tank	Diameter of Overflow Pipe (Inches ID)	Maximum Capacity of Water Supply Line to Tank	Diameter of Overflow Pipe (Inches ID)
0- 13 gpm -----	1½	356- 640 gpm -----	5
14- 55 gpm -----	2	641-1040 -----	6
56-100 gpm -----	2½	over-1040 gpm -----	8
101-165 gpm -----	3	—	—
166-355 gpm -----	4	—	—

(c) *Covers.* All gravity and unpressurized water supply tanks shall have a locked overlapping cover. The covers of these tanks shall be vented with a return bend vent pipe having an area not less than the area of the down feed riser pipe and the vent shall be screened with corrosion resistant screening having not less than 14 and not more than 20 openings per linear inch.

(d) *Potable water inlet control and location.* Potable water inlets to gravity and unpressurized tanks shall be controlled by an automatic supply valve so installed as to prevent the tank from overflowing. The inlet shall be terminated so as to provide an approved air-gap, but in no case less than 6 inches above the overflow.

(e) *Tank drain pipes.* Each tank shall be provided at its lowest point with a valved pipe to permit emptying the tank which shall discharge as required for overflow pipes and not smaller in size than shown in table 18.

Table 18

SIZE OF DRAIN PIPES FOR NONPRESSURIZED WATER TANKS

Tank Capacity (gallons)	Drain Pipe (inches)	Tank Capacity (gallons)	Drain Pipe (inches)
Up to 750	1	3001 to 5000	2½
751 to 1500	1½	5001 to 7500	3
1501 to 3000	2	over 7500	4

(f) *Low pressure cut-off required on booster pumps.* When a booster pump is used on a water pressure booster system, there shall be installed a low pressure cut-off on the booster pump to prevent a pressure of less than 20 p.s.i.g. on the inlet side of the pump.

(g) *Pressure tanks, vacuum relief.* All elevated water pressure tanks 20 feet to the bottom of the tank or more above the lowest fixture shall be provided with a vacuum relief valve at the top of the tank which will operate up to a maximum water pressure of 200 p.s.i. and to maximum water temperatures of 200°F. The minimum size of such vacuum relief valves shall be ½ inch.

(6) **DISINFECTION OF POTABLE WATER SYSTEM.** (a) *Procedure.* New or repaired potable water systems shall be disinfected prior to use. The method to be followed shall be as follows.

1. The pipe system shall be flushed with clean, potable water until no dirty water appears at the points of outlet.

2. The system or part thereof shall be filled with a solution of water and chlorine containing at least 50 parts per million of chlorine and the system or part thereof shall be valved off and allowed to stand for 24 hours or the system or part thereof shall be filled with a solution of water and chlorine containing at least 200 parts per million of chlorine and allowed to stand for 3 hours.

3. Following the allowed standing time, the system shall be flushed with clean potable water until no chlorine remains in the water coming from the system.

4. The procedures shall be repeated if it is shown by a bacteriological examination that contamination still exists in the system.

(b) *Water quality analysis.* The department may require a water quality analysis to be done for a new or repaired potable water system. The analysis shall be performed in accordance with acceptable nationally recognized laboratory practices. The water samples for the analysis may not be taken sooner than 24 hours after the system has been disinfected under par. (a).

(7) **SPECIAL EQUIPMENT.** (a) *Separate piping for each source.* A water supply that meets accepted standards for purity for human consumption shall be distributed through a piping system entirely independent of any piping system conveying another water supply.

(b) *Piping by plumber.* Only persons licensed by the department as a master, journeyman plumber or a registered plumber apprentice, under supervision, shall install water supply piping to any system designed for steam power, heating, temperature regulation, automatic fire protection,

air-conditioning, comfort cooling, process piping, hydraulic power or for any special water usage for industrial or manufacturing purposes. All such piping for supplying water for any of the above listed uses shall be brought by the licensed plumber to a point within the building or structure and within 10 feet of the point of entry to any of the above systems where it shall terminate with an air-gap or other method approved by the department.

(c) *Piping by equipment installers.* Connection of systems specified in par. (b) to the water supply pipe and the discharge therefrom through an air-gap into a trap, fixture, receptacle or interceptor installed by the licensed plumber, as prescribed by rules and regulations, may be made by the person installing such systems.

History: 1-2-56; r. and recr. Register, November, 1972, No. 203, eff. 12-1-72; r. and recr. Register, February, 1979, No. 278, eff. 3-1-79; renum. from H 62.13, Register, July, 1983, No. 331, eff. 8-1-83; renum. from ILHR 82.13 and r. and recr. (2) (b) and (4) (d) 1., am. (4) (c) 3. and (6) (a) (intro.), cr. (6) (b), Register, February, 1985, No. 350, eff. 3-1-85.

**ILHR 82.41 Back-siphonage, cross-connections and potability control. (1) PROTECTION OF POTABLE WATER SUPPLY. (a) General.** Potable water supply systems shall be designed, installed and maintained in such manner as to prevent contamination from non-potable liquids, solids or gases from being introduced into the potable water supply through cross-connections or any other piping connections to the system.

(b) *Interconnections.* Interconnections of water services between 2 or more public water systems, water distribution systems, or a private and public supply shall be permitted only with approval of the department.

(c) *Cross-connection control.* Cross-connections are prohibited except as approved by the department when suitable protective devices such as the reduced pressure zone backflow preventer or equal are installed, tested and maintained to insure proper operation on a continuing basis.

(d) *Water treatment.* All water treatment compounds approved by the department for introduction into the potable water distribution system shall be by a positive displacement pump.

(e) *Painting of water tanks.* The interior surface of the potable water tank shall not be lined, coated, painted or repaired with any material which will affect either the taste, odor, color or potability of the water supply when the tank is placed in or returned to service.

(f) *Used piping.* Piping which has been used for any other purpose than conveying potable water shall not be used for conveying potable water.

(g) *Water supply to boilers.* Potable water supply to boilers or boiler feed water systems shall be through an air-gap or approved backflow preventer.

(h) *Prohibited connections to fixtures and equipment.* Connection to the potable water supply system for the following shall be protected against backflow or back-siphonage.

1. Operating, dissection, embalming and mortuary tables or similar equipment. In such installations the hose used for water supply shall terminate at least 12 inches away from every point of the table or attachments. See following sketch.

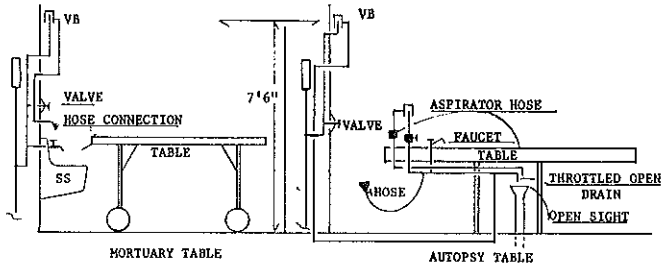

2. No closet bowl or other fixture equipped with a flushometer valve or with flushing tanks shall be installed with a side or rear spud located below the lower part of the flush rim of the bowl.

3. Seat acting water closets.
4. Bedpan washers.
5. Bidets.
6. Sterilizers with water supply connections.
7. Therapeutic baths with inlets below the rim of the fixture.
8. Water operated waste ejectors.
9. Bathtubs with inlets below the rim of the fixture.
10. Wash basins with inlets below the rim of the fixture.
11. Bar, soda fountain or other sinks with submerged inlets.
12. Laundry trays with faucets below the rim.
13. Sinks with faucets or water inlets below the rim and sinks with loose hose connections.
14. Dishwashing sinks or machines with water inlets below the rim.
15. Cuspidors with water supply connections.
16. Dental cuspidors with water supply connections.
17. Hospital appliances.
18. Frostproof hydrants with underground bleed or an automatic live-stock water device.
19. Industrial vats, tanks, etc., of a description which have an inverted water supply connection or a water supply connection below the top of the spill rim or in which a hose filler is used.

20. Industrial water supplied process appliance with direct water connections.

21. A rubber hose with hand control or self-closing faucets attached as used in connection with baths, industrial vats, canneries, etc.

22. Pressure water supplied sealing rings on sewage and sludge pumps.

23. Water supply for priming connections.

24. Water supply (hot or cold) to laundry equipment.

25. Condenser cooling connections for refrigeration and air-conditioning machinery.

26. Drains from fire sprinklers connected direct to sewer or waste.

27. Steam tables.

28. Condensers.

29. Stills.

30. Aspirators.

31. Chlorinators.

32. Photographic developing tanks.

33. Fixture inlets or valve outlets with hose attachments which may constitute a cross-connection shall be protected by an approved vacuum breaker installed at least 6 inches above the highest point of usage and located on the discharge side of the last valve. Manufactured fixtures with integral vacuum breakers shall be approved by the department.

34. Laboratory water faucets and cocks with serrated nipples or hose connections.

35. Lawn sprinkling faucets.

36. Any other fixture or installation creating a backflow or back-siphonage hazard.

(i) *Used water return prohibited.* Water used for cooling of equipment, space heating or other processes shall not be returned to the potable water system. Such water shall be discharged into a drainage system through an air-gap or may be used for non-potable purposes on written approval of the department.

(j) *Water outlets.* A potable water system shall be protected against the backflow and back-siphonage by providing at each water outlet:

1. An air-gap as specified herein between the potable water outlet and the flood level rim of the fixture it supplies or between the water outlet and any other source of contamination or,

2. Where an air-gap is impractical, a backflow preventer device or vacuum breaker approved by the department.

(k) *Minimum required air-gap.* Minimum required air-gap shall be measured vertically from the lowest end of a potable water outlet to the flood rim or line of the fixture or receptacle into which it is discharged. The minimum required air-gap shall be twice the effective opening of a

potable water outlet unless the outlet is a distance less than 3 times the effective opening away from a wall or similar vertical surface in which case the minimum required air-gap shall be 3 times the effective opening of the outlet. In no case shall the minimum required air-gap be less than shown in table 19.

**Table 19**  
**MINIMUM AIR-GAPS FOR PLUMBING FIXTURES**

FIXTURE	MINIMUM AIR-GAP	
	When Not Affected By Near Wall (Inches)	When Affected By Near Wall (Inches)
Lavatories and other fixtures with effective opening not greater than ½ inch diameter—	1	1½
Sink, laundry trays, goose-neck bath faucets and other fixtures with effective openings not greater than ¾ inch diameter-----	1½	2¼
Over rim bath fillers and other fixtures with effective openings not greater than 1 inch diameter -----	2	3
Drinking water fountains—single orifice not greater than 7/16 (0.437) inch diameter or multiple orifices having total area of 0.150 square inches (area of circle 7/16 inch diameter)-----	1	1½
Effective openings greater than one inch-----	2 x diameter of effective opening	3 x diameter of effective opening

(l) *Devices for the protection of potable water supply.* Approved backflow preventers or vacuum breakers shall be installed with any plumbing fixture or equipment, the potable water supply outlet of which may be sub-merged and which cannot be protected by a minimum air-gap.

(m) *Approval of devices.* Before any device for the prevention of back-flow or back-siphonage is installed, it shall be approved by the department. In its determination, the department may use the results of a recognized testing laboratory. Devices installed in the building potable water supply distribution system for protection against backflow or back-siphonage shall be maintained in good working condition by the person or persons responsible for the maintenance of the system.

(n) *Protective devices required.* In the installation of the following list of fixtures and devices where an air-gap is not provided or is impractical, approved protective devices shall be installed in all supply lines according to table 20.

Table 20

CROSS-CONNECTIONS WHERE PROTECTIVE DEVICES ARE REQUIRED AND CRITICAL LEVEL (C-L) SETTINGS FOR BACKFLOW PREVENTERS<sup>1</sup>

Fixture or Equipment	Method of Installation
Aspirators and ejectors -----	C-L at least 6 inches above flood level of receptacle
Cup beverage vending machines ---	C-L at least 12 inches above flood level of machine
Dental units -----	On models without built-in vacuum breakers C-L at least 6 inches above flood level rim of bowl
Dishwashing machines -----	C-L at least 6 inches above flood level of machine
Flushometers (closet and urinal) ---	C-L at least 6 inches above top of fixture supplied
Garbage can cleaning machines ---	C-L at least 6 inches above flood level of machine
Hose outlets -----	C-L at least 6 inches above highest point on hose line
Laundry machines -----	C-L at least 6 inches above flood level of machine
Turf irrigation systems -----	C-L at least 12 inches above highest sprinkler or discharge outlet
Steam tables -----	C-L at least 6 inches above flood level
Tanks and vats -----	C-L at least 6 inches above flood level rim or line
Flush tanks -----	Equip with an approved ballcock. In all cases the ballcock should be located above the overflow level of the tank and the outlet terminated one inch above the overflow or provided with a backflow preventer located at least one inch above the overflow
Hose bibbs (where aspirators or ejectors could be connected) -----	C-L at least 6 inches above flood level of receptacle served

<sup>1</sup> Critical Level (C-L) is defined as the level to which the backflow preventer (vacuum breaker) may be submerged before backflow will occur. Where C-L marking is not shown on the preventer, the bottom of the device shall be taken as the C-L.

(o) *Connections subject to back pressure.* Where a potable water connection is made to a pipe line, fixture, tank, vat, pump or other equipment with a hazard of backflow or back-siphonage and where the water connection is subject to back pressure and an air-gap cannot be installed, the department shall require the use of an approved reduced pressure zone backflow preventer. A partial list of such connections is shown in Table 21.

Table 21

## PARTIAL LIST OF CROSS-CONNECTIONS SUBJECT TO BACK PRESSURE

Chemical lines	Pumps
Cup beverage vending machines	Steam lines
Dock water outlets	Swimming pools
Individual water supplies	Tanks and vats—bottom inlets
Industrial process water lines	Hose bibbs
Pressure tanks	

(p) *Installation of devices.* 1. Vacuum breakers. Vacuum breakers shall be installed with the critical level at least 6 inches above the flood level rim of the fixture they serve and on the discharge side of the last control valve to the fixture. No shut-off valve or faucet shall be installed beyond the vacuum breaker.

2. Reduced pressure zone backflow preventer. A reduced pressure zone type backflow preventer may be installed subject to full static pressure.

3. Devices of all types. Backflow and back-siphonage preventing devices shall be accessibly located, preferably in the same room with the fixture they serve. Installation in utility or service spaces, provided they are readily accessible is also permitted.

4. Barometric loop. Water connections not subject to back pressure where an actual or potential backflow or back-siphonage hazard exists may in lieu of devices specified, be provided with a barometric loop. See following sketch.

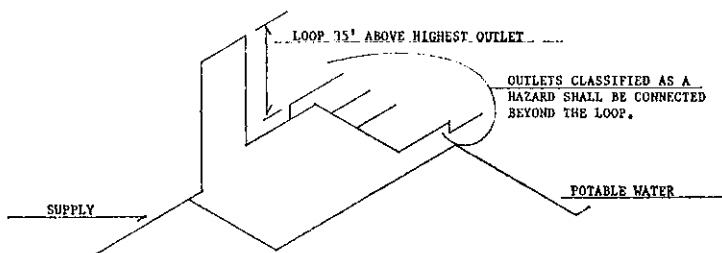

(q) *Turf sprinklers.* Turf sprinkler systems, when connected to a potable water system, shall be installed in accordance with these regulations. Adequate and proper provisions shall be made for control and drainage and to prevent back-siphonage or backflow. Water shall not be turned on to any turf sprinkler system until it has been inspected and approved. Materials used in turf sprinkler systems shall be submitted for evaluation and approval prior to installation.

*History:* 1-2-56; r. (2) through (7), Register, October, 1971, No. 190, eff. 11-1-71; r. and recr. Register, November, 1972, No. 203, eff. 12-1-72; renum. from H 62.14, Register, July, 1983, No. 331, eff. 8-1-83; renum. from ILHR 82.14 and am. (1) (h) 17., r. (2), Register, February, 1985, No. 350, eff. 3-1-85.

## Subchapter V Special Plumbing Installations

**ILHR 82.50 Health care and related facilities. (1) PLAN APPROVAL REQUIRED.** Plans for plumbing and equipment for health care facilities shall be approved by the department.

(2) **SCOPE.** The scope of this section shall cover devices, fixtures and equipment which are installed and maintained in health care facilities such as hospitals, nursing or rest homes, homes for the aged, infirmaries, residential care facilities, orphanages, sanitariums, sanatoriums, clinics, mortuaries, and schools of medicine, surgery, dentistry, and research and testing laboratories whether enumerated or not. This section may also apply to offices of dentists and doctors.

(3) **INTENT.** The primary intent of the following minimum requirements is to protect public health by eliminating either potential health or safety hazards to patients and institutional personnel, and to promote the efficient use, operation and maintenance of the equipment used in the



institution or establishment. Fixtures, devices and/or equipment in addition to those prescribed herein may be required dependent upon the type of occupancy, treatment, care or layout. Such additional facilities shall be installed in accord with the provisions of this chapter.

(4) **PLUMBING IN MENTAL HOSPITALS.** Special consideration shall be given to the design and installation of plumbing fixtures in areas where disturbed patients are housed. No pipes or traps shall be exposed and all fixtures shall be securely bolted through walls or floors.

(5) **SPECIAL FIXTURES AND EQUIPMENT ACCEPTABILITY.** (a) *Special fixtures.* Fixtures which are designed for any special use such as, therapy, special cleansing and/or disposal of waste materials shall be smooth, impervious, corrosion resistant materials and, if subject to temperatures in excess of 180°F., shall be able to withstand without damage, higher temperatures as may be specified. Scrub-up sinks, lavatories and sinks in patient care areas, and fixtures used by medical and nursing staff, shall have the water supply spout terminate a minimum of 5 inches above the rim of the fixture. These fixtures shall be equipped with valves or faucets which can be operated without use of the hands.

(b) *Special equipment.* All devices, appurtenances, appliances and apparatus intended to serve a special function such as sterilization, distillation, processing, cooling, storage of ice or foods, etc., which may be connected to either the water supply distribution or drainage systems or both, shall be provided with protection against back-siphonage, back-flow, flooding, fouling, or any possibility of contaminating any portion of the water supply system, or equipment, or the misuse of any drain.

(c) *Therapeutic equipment.* Therapeutic equipment shall not be counted as a patient bathing fixture to meet the required patient bath ratio.

(6) **FIXTURE AND EQUIPMENT INSTALLATION.** (a) *Clinic sinks.* Such fixtures shall have an integral trap in which the upper portion of a visible trap seal provides a water surface. The fixture shall be designed so as to permit complete removal of the contents by siphonic and/or blow-out action, and to reseal the trap in a single flushing operation. A flushing rim shall provide water to cleanse the interior surface. The fixtures shall have flushing and cleansing characteristics similar to a water closet.

(b) *Prohibited use of clinic sinks and service sinks.* A clinic sink shall not be used as a janitor's service sink. A janitor's service sink shall not be used for the disposal of urine, fecal matter, or other human wastes.

(c) *Special requirement for ice manufacture and storage.* 1. No machines for manufacturing ice, or any device for handling or storing ice, shall be located in a room containing a bedpan hopper, clinic sink, bedpan washer, or similar fixture. Machines for manufacturing ice, or devices for handling or storing ice intended for either human consumption or packs, shall be located in a clean utility room, a floor pantry, a diet kitchen, or in other similar locations.

2. Each drain serving an ice chest or box shall discharge into an indirect waste receptor. Each drain shall discharge through an air-break above the receptor. The end of the drain shall be covered with a removable 10 mesh per inch noncorrosive screen.

(7) **STERILIZERS.** (a) *Descaling prohibited.* The interior of water sterilizers, stills, or similar equipment shall not be descaled or otherwise treated by acid or other chemical solutions while the equipment is connected to the water and/or drainage systems.

(b) *Compliance with boiler and pressure vessel code.* Pressure sterilizers and pressure type instrument washer sterilizers installed after the effective date of this code shall be constructed and stamped in accordance with the provisions of chs. ILHR 41 and 42. All pressure sterilizers and pressure type instrument washer sterilizers regardless of size shall be equipped with pressure relief devices in accordance with the provisions of chs. ILHR 41 and 42.

(c) *Sterilizer piping.* The connecting piping and/or devices for sterilizers shall be accessible for inspection and maintenance.

(d) *Bedpan washers and clinic sinks.* Bedpan washers and clinic sinks shall be connected to the sanitary drainage system and vented in accordance with the requirements for water closets. Vapor vents serving bedpan washers shall not connect to the plumbing system.

(8) **DRAINAGE AND VENTING.** (a) *Sterilizer wastes.* 1. Indirect wastes required. All sterilizers shall be provided with individual and separate indirect wastes, with air-gaps of not less than 2 diameters of the waste tailpiece. The upper rim of the receptor, funnel, or basket type waste fitting shall be not less than 2 inches below the vessel or piping, whichever is lower. Except as provided in subds. 3. and 5., a "P" trap shall be installed on the discharge side of and immediately below the indirect waste connection serving each sterilizer.

2. Floor drain required. In any room containing the recessed, or concealed portions of sterilizers, not less than one acceptable floor drain, connecting to the drainage system, shall be installed in a manner to drain the entire floor area. The floor drain waste and trap shall be a minimum diameter of 3 inches. It shall receive the drainage from at least one sterilizer within the room to assure maintenance of the floor drain trap seal. The sterilizer drain may be installed on a branch taken off between the floor drain trap and the strainer. No individual sterilizer waste trap shall be required on this type of installation. See following sketch.

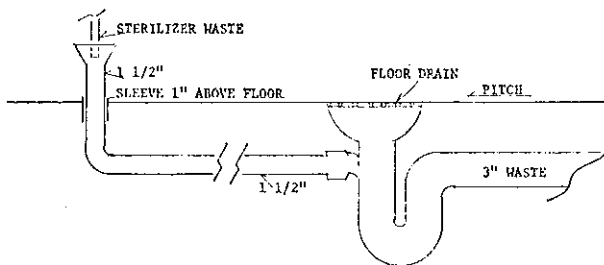

3. Battery assemblies. A battery assembly of not more than 3 sterilizer wastes may drain to one trap, provided the trap and waste are sized according to the combined fixture unit rating; the trap is located immediately below one of the indirect waste connections; the developed distance

of a branch does not exceed 8 feet; and the branches change direction through a tee-wye or wye pattern fitting.

4. Bedpan steamers, additional trap required. A trap with a minimum seal of 3 inches shall be provided in a bedpan steamer drain located between the fixture and the indirect waste connection.

5. Pressure sterilizer. Except when an exhaust condenser is used, a pressure sterilizer chamber drain may be connected to the exhaust drip tube before terminating at the indirect waste connection. If a vapor trap is used, it shall be designed and installed to prevent moisture being aspirated into the sterilizer chamber. The jacket steam condensate return, if not connected to a gravity steam condensate return, shall be separately and indirectly wasted. If necessary to cool a high temperature discharge, a cooling receiver, trapped on its discharge side, may serve as the fixture trap.

6. Pressure sterilizer exhaust condensers. The drain from the condenser shall be installed with an indirect waste. If condensers are used on pressure sterilizers, the chamber drain shall have a separate indirect waste connection.

7. Water sterilizer. All water sterilizer drains, including tank, valve leakage, condenser, filter and cooling, shall be installed with indirect waste or according to subd. 2.

8. Pressure instrument washer-sterilizer. The pressure instrument washer-sterilizer chamber drain and overflow may be interconnected. Also, they may be interconnected with the condenser.

(b) *Vapor vent material.* Material for vapor vents serving bedpan washers and sterilizer vents serving sterilizers shall be materials approved for vent piping.

(c) *Vent connections prohibited.* Connections between vapor vents serving bedpan washers, sterilizing apparatus, and/or normal sanitary plumbing systems, are prohibited.

(d) *Vapor vents and stacks.* 1. Bedpan washers shall be vented to the outer atmosphere above the roof by means of one or more vapor vents. The vapor vent for a bedpan washer shall be not less than a 2-inch diameter pipe. A vapor vent serving a single bedpan washer may drain to the fixture served.

2. Multiple installations. Where bedpan washers are located above each other on more than one floor, a vapor vent stack may be installed to receive the vapor vent on the various floors. Not more than 3 bedpan washers shall be connected to a 2-inch vapor vent stack, 6 to a 3-inch vapor vent stack, and 12 to a 4-inch vapor vent stack. In multiple installations, the connections between a bedpan washer vapor vent and a vapor vent stack shall be made by use of a tee or tee-wye sanitary pattern drainage fittings, installed in an upright position.

3. Trap required. The bottom of the vapor vent stack, except when serving only one bedpan washer, shall be drained by means of a trapped and vented waste connection to the plumbing sanitary drainage system. The trap and waste shall be the same size as the vapor vent stack.

4. Trap seal maintenance. A water supply of not less than ¼ inch minimum tubing shall be taken from the flush supply of each bedpan washer on the discharge or fixture side of the vacuum breaker, trapped to form not less than a 3-inch seal, and connected to the vapor vent stack on each floor. The water supply shall be so installed as to provide a supply of water to the vapor vent stack for cleansing and drain trap seal maintenance each time a bedpan washer is flushed.

(e) *Sterilizer vapor vent and stacks.* 1. Connections. Multiple installations of pressure and nonpressure sterilizers shall have their vent connections to the sterilizer vent stack made by means of inverted wye fittings. Such vent connections shall be accessible for inspection and maintenance.

2. Drainage. The connection between sterilizer vent and/or exhaust openings and the sterilizer vent stack shall be designed and installed to drain to the funnel or basket-type waste fitting. In multiple installations, the sterilizer vent stack shall be drained separately to the lowest sterilizer funnel or basket-type waste fitting or receptor.

(f) *Sterilizer vapor vent stack sizes.* 1. Bedpan steamers. The minimum size of a sterilizer vent serving a bedpan steamer shall be 1½ inches in diameter. Multiple installation shall be sized according to table 22.

**Table 22**  
**VAPOR VENT STACK SIZES FOR BEDPAN STEAMERS AND**  
**BOILING TYPE STERILIZERS**

(Number of connections of various sizes permitted to various sized sterilizer vent stacks)

Stack size	Connection size	
	1½"	2"
1½-inch <sup>1</sup>	1 or	0
2-inch <sup>1</sup>	2 or	1
2-inch <sup>2</sup>	1 and	1
3-inch <sup>1</sup>	4 or	2
3-inch <sup>2</sup>	2 and	2
4-inch <sup>1</sup>	8 or	4
4-inch <sup>2</sup>	4 and	4

<sup>1</sup>Total of each size.  
<sup>2</sup>Combination of sizes.

2. Boiling type sterilizers. The minimum size of a sterilizer vent stack shall be 2 inches in diameter when serving a utensil sterilizer, and 1½ inches in diameter when serving an instrument sterilizer. Combinations of boiling type sterilizer vent connections shall be based on table 22.

3. Pressure sterilizers. Sterilizer vent stacks shall be 2½ inches minimum; those serving combinations of pressure sterilizer exhaust connections shall be sized according to table 23.

Table 23

VAPOR VENT STACK SIZES FOR PRESSURE STERILIZERS  
(Number of connections of various sizes permitted to various sized vent stacks)

Stack size	Connection size			
	¾"	1"	1¼"	1½"
1½-inch <sup>1</sup> .....	3 or	2 or	1	
1½-inch <sup>2</sup> .....	2 and	1		
2-inch <sup>1</sup> .....	6 or	3 or	2 or	1
2-inch <sup>2</sup> .....	3 and	2		
2-inch <sup>2</sup> .....	2 and	1 and	1	
2-inch <sup>2</sup> .....	1 and	1 and		1
3-inch <sup>1</sup> .....	15 or	7 or	5 or	3
3-inch <sup>2</sup> .....		1 and	2 and	2
3-inch <sup>2</sup> .....	1 and	5 and		1

<sup>1</sup>Combination of sizes.

<sup>2</sup>Total of each size.

4. Pressure instrument washer-sterilizer sizes. The minimum size of a sterilizer vent stack serving an instrument washer-sterilizer shall be 2 inches in diameter. Not more than 2 sterilizers shall be installed on a 2-inch stack, and not more than 4 on a 3-inch stack.

(9) FLOOR DRAINS PROHIBITED. Floor drains shall not be installed in operating or delivery rooms.

(10) WATER SUPPLY. (a) *Water services*. All hospitals shall be provided with at least 2 water service connections and whenever more than one street main is available, the connections shall be made to different street mains.

1. The water service pipe for all other health care facilities shall be of sufficient size to furnish water to the building in the quantities and at the pressures required in s. ILHR 82.40 (4) and (5) and par. (c).

2. Water services shall be in accord with the requirements of s. ILHR 82.40 (2).

(b) *Water distribution control valves*. 1. Four or less patient care units, containing not more than 2 persons per unit exclusive of intensive care coronary units, may be served with one branch control valve. All fixtures, appliances, appurtenances, lawn sprinkler faucets and wall hydrants shall be valved. See following sketch.

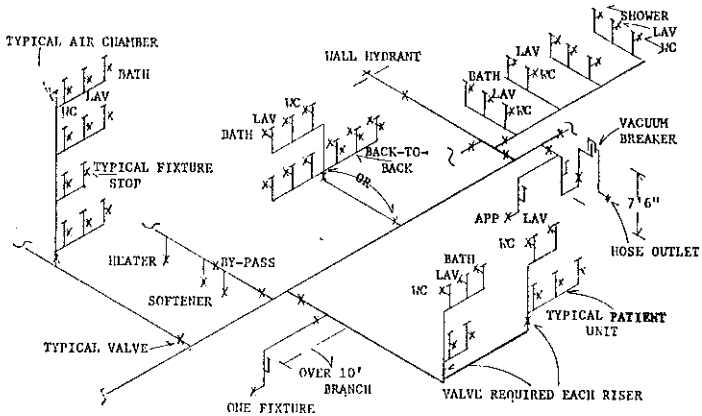

2. Control valves for risers, water heating equipment, water softeners and tank controls shall be in accord with s. ILHR 82.40 (4) (j) 2. b. c. d. and g. Control valve accessibility and design shall be in accord with s. ILHR 82.40 (4) (j) 2. e. and f. See above sketch.

(c) *Velocities and flow capacities.* Water supply piping shall be designed to provide service to upper floor installations at a minimum pressure of 15 (p.s.i.) pounds per square inch during maximum demand periods. Velocities shall not exceed 8 (f.p.s.) feet per second. Where static pressure exceeds 80 (p.s.i.) pounds per square inch, pressure reducing controls shall be installed to avoid fracture or other damage to the system. The supply demand in gallons per minute in the building water distribution system shall be determined on the basis of the load in terms of supply fixture units and of the relationship between load and supply demand as shown in table 24 and pertinent portions of tables 13 and 14.

Table 24  
DATA FOR ESTIMATING WATER SUPPLY DEMAND AND WASTE REQUIREMENTS

Fixture	Fixture Units		Minimum Pipe Sizes, Inches					Remarks
	Water	Waste	Trap	Vent	Cold Water	Hot Water		
Water closet (tank)	6	6	2	2	1	1/2	H.W. required with bedpan washer hose only	
Water closet (flush valve)	10	8	2	2	1	1/2		
Lavatory	2	1	1/4	1/4	1/2	1/2		
Urinal (tank)	3	4	2	1/2	1	1/2		
Urinal (flush valve)	5	4	2	1/2	1	1/2		
Shower	4	2	3	1/2	1/2	1/2		
Patient bath (public)	4	3	1 1/2	1 1/2	1/2	1/2		
Patient bath (pvt.)	4	3	1 1/2	1 1/2	1/2	1/2		
Drinking fountain	2	3	1 1/2	1 1/2	1/2	1/2		
Sitz bath	1	1/2	1 1/2	1 1/2	1/2	1/2		
Clinical sink	4	3	1 1/2	1 1/2	1/2	1/2		
(Flushing rim)	10	6	3	2	1	3/4		
Scrub sink	4	3	2	1 1/2	3/4	1/2	2, 3 or 4 place sink	
Single sink for misc. hospital use	4	3	2	1 1/2	3/4	1/2		
Double sink for misc. hospital use	4	4	2	1 1/2	3/4	1/2		
Laboratory sink	2	2	1 1/2	1 1/2	1/2	1/2		
Ice machine	1	1	2	1 1/2	3/4	3/4		
Plaster sink	6	2	2SD	2	3/4	3/4		
X-ray tank	4	2	1 1/2	1 1/2	1/2	1/2		
Bedpan sanitizer	4	2	1 1/2	1 1/2	1/2	1/2		
Autopsy table	10	6	3	2	1	1/2	Use with plaster trap Based on 18 x 30 x 22-inch tank 1/2-inch STM connection	
Animal area sinks	4	4	1 1/2	1 1/2	1/2	1/2		
Cup sink	4	4	2	1 1/2	3/4	3/4		
	1	1	1 1/4	1 1/4	1/2	1/2		

(d) *Piping insulation.* Circulating, hot, cold and chilled water piping shall be insulated. Cold and chilled water pipe insulation shall have an integral or separate vapor barrier.

(e) *Special piping systems.* Distilled water, ionized water, laboratory and other special piping systems shall be included in the plans submitted. The plans shall incorporate sufficient detail to clearly establish the installation proposed.

(f) *Water supply protection.* The installation of the water supply shall meet all the applicable requirements prescribed in ss. ILHR 82.40 and 82.41, and as provided in table 25 including the corresponding reference number.

Table 25

Equipment	Protective Device	Location	Reference No.
Bath with shampoo nozzle—	Vacuum breaker	6'0" above bottom of tub	1
Bedpan sanitizer-----	Vacuum breaker	Part of flush valve	1
Bedpan washer hose -----	Vacuum breaker	5'9" above floor	1
Hose and faucet at service sink-----	Vacuum breaker	6' above normal use of hose	1
Sterilizer condenser -----	Vacuum breaker	6" above unit	1
Flash washer -----	Vacuum breaker	6" above unit	1
Glove washer -----	Vacuum breaker	6" above unit	1
Stills -----	Air-gap	On discharge	5
Ultrasonic cleaner-----	Vacuum breaker	6" above unit	1
Developing tank-----	Vacuum breaker	6" above unit	1
Dental unit -----	Vacuum breaker	Part of unit	1
Hydrotherapy bath-----	Vacuum breaker	6" above unit	1
Radiology cooling coil (water bath) -----	Air-gap	On discharge	5
Pipette washer -----	Vacuum breaker	6" above unit	1
Laboratory spout -----	Vacuum breaker	At threaded discharge	2
Cage washer -----	Vacuum breaker	6" above unit	1
Tube washer -----	Vacuum breaker	Part of control valve	1
Bottle washer -----	Vacuum breaker	6" above unit	1
Food waste grinder -----	Vacuum breaker	6" above unit	1
Peeler -----	Air-gap	On supply	4
Dishwasher -----	Vacuum breaker	6" above unit	1
Can washer -----	Vacuum breaker	6" above unit	1
Ice machine -----	Air-gap	On discharge	5
Pot washer -----	Vacuum breaker	6" above unit	1
Coffee urn -----	Vacuum breaker	6" above unit	1
Glass washer -----	Vacuum breaker	6" above unit	1
Refrigeration condenser -----	Air-gap	On discharge	5
Clothes washer-----	Vacuum breaker	6" above unit	1
Soap and brine tanks-----	Vacuum breaker	6" above unit	1
Autopsy table-----	Vacuum breaker	6'0" above floor	1
Aspirator -----	Vacuum breaker	6'0" above floor	1
Hose station -----	Vacuum breaker	At threaded discharge	2
Flush rim floor drain -----	Vacuum breaker	5'9" above floor	1
Incinerator gas washer-----	Air-gap	On water supply	5
Lawn sprinklers -----	Vacuum breaker	Outdoor type	1
Wall hydrant -----	Vacuum breaker	At threaded discharge	2
Hose bibb -----	Vacuum breaker	At threaded discharge	2
Package air-conditioner -----	Air-gap	On discharge	5
Cooling tower -----	Backflow preventer	On water supply	3
Boiler make-up water -----	Backflow preventer	On water supply	3
Vacuum pumps and air washing -----	Air-gap	On water supply	4
Spray coil for air washing-----	Vacuum breaker	6" above unit	1
Expansion tank -----	Backflow preventer	On water supply	3



1. The designation "vacuum breaker" means a non-pressure, atmospheric type device. The installation elevation means the distance above the spill level of the fixture or equipment served, or the height to which a connected discharge may be raised to cause gravity back-flow to reach the device. The designated installation shall be measured from the bottom of the device, or the critical level marking if indicated on the device. The installation and elevation shall permit the vacuum breaker to drain and actuate each time the control valve is operated. No shut-off valve shall be permitted downstream from the vacuum breaker. The vacuum breaker shall not be installed in a manner so as to be under continuous pressure.

2. The location "at the threaded discharge" means the location where an aerator would normally be installed. The vacuum breaker is the in-line type and for the laboratory faucet the serrated nozzle is then screwed into the discharge end of the vacuum breaker. When this vacuum breaker is used with a hose bibb, it is threaded onto the male end and the hose is connected to the vacuum breaker.

3. The designation "backflow preventer" means the reduced pressure type backflow preventer which includes two spring loaded check valves, a broken connection to a drain and usually two gate valves. The use of this device requires that adequate and rapid drainage be available.

4. An air-gap on the water supply means that the air-gap shall be located at the supply opening to the fixture or equipment it serves. An air-gap is the minimum vertical distance between the supply discharge orifice and the spill level of the receptor, fixture or equipment served. This minimum vertical distance shall be at least 2 diameters of the discharge orifice, or a minimum of one inch, whichever is the greatest.

5. An air-gap on the waste line means an indirect connection between the fixture or equipment and the waste receptor. The waste discharge orifice governs the minimum distance according to subd. 4.

(g) *Hot water supply control.* Hot water supply to patients' showers, therapeutic equipment, and continuous baths shall be provided with control valves automatically regulating the temperature of the water supply to the fixture. The valve shall fail in a closed position when the tempered water supply to the fixture exceeds 110°F.

(h) *Hot water supply.* The water supply distribution system shall be designed to provide hot water at each applicable fixture at all times. The system shall be of a circulating type. The circulating pumps shall be arranged for continuous operation or shall be controlled by an aquastat in the circulating piping. See s. ILHR 82.40 (4) (f).

(i) *Water heaters and tanks.* Storage tanks when provided shall be fabricated of non-corrosive metal or be lined with non-corrosive material. The water heating equipment shall have a sufficient capacity to supply water at the temperature and amounts in table 26.

Table 26

	Patient Areas	Clinical	Dietary	Laundry (2 gals. per lb. of laundry)
Gal/hr/bed -----	6½	6½	4	4½
Temp. °F. (Maximum) -----	110°	125°	180°	180°

(11) **ASPIRATORS.** The use of water aspirators shall be limited to those units approved by the department.

(12) **SPOUTS AND ACTIONS—HOSPITAL AND NURSING HOME FIXTURES.**

(a) The selection of spouts and actions for hospital and nursing home plumbing fixtures shall comply with par. (b) and table 27.

(b) Lavatories and sinks required in patient care areas shall have the water supply spout mounted so that its discharge point is a minimum distance of 5 inches above the rim of the fixture. All fixtures used by medical and nursing staff, and all lavatories used by patients and food handlers shall be trimmed with valves which can be operated without the use of hands. Where blade handles are used for this purpose they shall not exceed 4½ inches in length, except that handles on scrub sinks and clinical sinks shall be not less than 6 inches long.

Table 27

## SPOUTS AND ACTIONS FOR HOSPITAL AND NURSING HOME FIXTURES

Location	Type of Spout	Type of Action Minimum
<b>NURSING DEPARTMENT</b>		
Patient toilet room -----	Gooseneck	Wrist
Patient toilet room— isolation -----	Gooseneck	Knee
Utility room -----	Gooseneck	Wrist
Treatment room -----	Gooseneck	Wrist
Medicine room -----	Gooseneck	Wrist
Lavatory in floor kitchen -----	Gooseneck	Wrist
Sink in floor kitchen -----	Sink faucet	Wrist
Nurses toilet room -----	Lavatory supply	Hand
Floor laboratory -----	Laboratory gooseneck	Vertical hand
<b>NURSERY</b>		
Nursery -----	Gooseneck	Wrist
Suspect nursery -----	Gooseneck	Wrist
Examination and treatment -----	Gooseneck	Wrist
Premature nursery -----	Gooseneck	Foot
Formula room -----	Gooseneck	Wrist
Labor room -----	Gooseneck	Wrist
<b>SURGICAL</b>		
Scrub room -----	Gooseneck with spray head	Knee
Sub-sterile room -----	Sink faucet	Wrist
Clean-up room -----	Sink faucet	Wrist
Frozen sections room -----	Laboratory gooseneck	Vertical hand
Surgical supply room -----	Gooseneck	Wrist
Work room -----	Sink faucet	Wrist
Cystoscopic room -----	Gooseneck with spray head	Knee
Fracture room -----	Sink faucet	Wrist
Recovery room -----	Gooseneck	Foot
<b>CENTRAL SUPPLY</b>		
Work room -----	Sink faucet	Wrist
Solutions room -----	Sink faucet	Wrist
Needle and syringe room -----	Sink faucet	Wrist
Glove room -----	Gooseneck	Wrist
Pharmacy -----	Laboratory gooseneck	Vertical hand
Manufacturing -----	Gooseneck	Wrist
<b>EMERGENCY DEPARTMENT</b>		
Observation bedroom -----	Gooseneck	Wrist
Utility room -----	Gooseneck	Wrist
Operating room -----	Gooseneck with spray head	Knee
D.O.A. room -----	Gooseneck	Wrist
Examination room -----	Gooseneck	Wrist
<b>DIAGNOSTIC AND TREATMENT</b>		
Occupational therapy -----	Gooseneck	Wrist
Hydro-therapy room -----	Gooseneck	Wrist
Examination room -----	Gooseneck	Wrist
Deep therapy -----	Gooseneck	Wrist
Superficial therapy -----	Gooseneck	Wrist
Radium treatment and exam -----	Gooseneck	Wrist
Toilet room -----	Gooseneck	Wrist
Dark room -----	Sink faucet	Hand
Autopsy -----	Gooseneck with spray head	Knee
Lavatory in autopsy shower room -----	Gooseneck	Wrist
Laboratories -----	Laboratory gooseneck	Vertical hand
<b>OUTPATIENT DEPARTMENT</b>		
Examination and treatment room -----	Gooseneck	Wrist
Dental operating -----	Gooseneck	Knee
Dental laboratory -----	Laboratory gooseneck	Vertical hand
Dental recovery -----	Gooseneck	Wrist
Surgical room -----	Gooseneck with spray head	Knee
Eye examination room -----	Gooseneck	Knee
Ear, nose and throat room -----	Gooseneck	Knee
<b>SERVICE DEPARTMENT</b>		
Lavatory in kitchen -----	Lavatory supply	Wrist

(13) RADIOACTIVE MATERIALS. See ch. HSS 157.

History: 1-2-56; am. (3) (4) and (5), Register, August, 1961, No. 68, eff. 9-1-61; r. and recr. Register, November, 1972, No. 203, eff. 12-1-72; r. and recr., Register, February, 1979, No. 278, eff. 3-1-79; renum. from H 62.16, Register, July, 1983, No. 331, eff. 8-1-83; renum. from ILHR 82.16 and am. (7) (b), (10) (a) 1. and 2., (b) 2., (f) (intro.) and (h), Register, February, 1985, No. 350, eff. 3-1-85.

**ILHR 82.51 Mobile home sites and parks. (1) DRAIN SYSTEMS. (a) Private interceptor main sewer.** The maximum number of mobile homes served by private interceptor main sewer shall be in accordance with Table 82.51.

**Table 82.51**  
**MAXIMUM NUMBER OF MOBILE HOMES SERVED BY A PRIVATE INTERCEPTOR MAIN SEWER**

Diameter of Private Interceptor Main Sewer (in inches)	Pitch (inch per foot)		
	1/16	1/8	1/4
4	None	2	2
5	2	2	2
6	26	34	49
8	Load Shall Not Exceed Capacity of Pipe <sup>a</sup>		

Note a: See s. ILHR 82.30 (4) (d).

(b) *Building sewer.* The building sewer for a mobile home shall be at least 4 inches in diameter.

(c) *Mobile home drain connector.* The piping between the mobile home drain outlet and the building sewer shall have a minimum slope of ¼ inch per foot, and shall be of materials approved for above ground drain and vent pipe in accordance with ch. ILHR 84. The connector shall be protected against freezing.

(d) *Other requirements.* Mobile home park sewer systems shall also conform to the applicable requirements of s. ILHR 82.30.

(2) **WATER SUPPLY SYSTEMS. (a) Private water mains. 1.** Supply demand. The supply demand in gallons per minute in the private water main system shall be determined on the basis of the load in terms of water supply fixture units, and in terms of the relationship between load and supply demand. The demand load of a mobile home site shall be equivalent to at least 15 water supply fixture units.

2. Sizing. The private water mains shall be sized in accordance with s. ILHR 82.40. A private water main serving a mobile home park shall not be less than one inch in diameter.

3. Pressure. The minimum pressure within a private water main shall be sufficient to maintain a pressure of 20 psi at each mobile home site under normal operating conditions.

4. Valving. Each private water main shall be provided with a gate or full flow valve at its source and at each branch connection. The valves shall be installed in a manhole or valve box so as to be accessible for operation.

(b) *Water services. 1. Size.* Each mobile home site shall be served by a separate water service not less than ¾ inch in diameter.

2. Valving. a. Each water service shall be provided with a curb stop within each mobile home site but not under the parking hard stand or pad.

b. A valve, of at least  $\frac{3}{4}$  inch diameter, shall be located on the upper end of the water service pipe. In lieu of the valve located on the upper end of the water service, a freezeless type hydrant of at least  $\frac{3}{4}$  inch diameter may be used.

c. The installation of underground stop and waste valves shall be prohibited.

3. Mobile home water connector. The piping between the mobile home water inlet and the water service shall be of materials approved for water distribution pipe in accordance with s. ILHR 84.30 (3).

(c) *Protection against freezing.* All water main and water service piping shall be protected against freezing.

(d) *Separation of water and sewer piping.* Separation of water and sewer piping shall be in accordance with s. ILHR 82.40 (2) (d).

(e) *Other requirements.* Mobile home park water supply systems shall also conform to the applicable requirements of s. ILHR 82.40.

(3) BUILDING SEWER AND WATER SERVICE TERMINATIONS. (a) *Frost sleeves.* Each building sewer and water service shall have a frost sleeve extending at least 42 inches below grade. The sleeve shall be of a material approved for building sewers. Frost sleeves shall terminate at grade. A frost sleeve shall be covered or sealed when not in use.

(b) *Termination elevation.* Each water service shall terminate at least 6 inches above the surrounding finished grade. Each building sewer shall terminate at least 4 inches above the surrounding finished grade and shall not terminate higher than the water service pipe.

(c) *Piping not in use.* A building sewer or water service pipe not connected to a mobile home shall be capped or plugged.

Note: See Appendix for further expository material.

History: Cr. Register, February, 1985, No. 350, eff. 3-1-85.

## Subchapter VI Installation

**ILHR 82.60 Pipe hangers and supports.** The provisions of this section control the types, materials and installation of anchors, hangers and supports for plumbing piping.

(1) MATERIAL. (a) *Strength.* Hangers, anchors and supports for piping less than  $1\frac{1}{4}$  inch in diameter shall be of sufficient strength to support the piping and its contents. Hangers, anchors and supports for piping  $1\frac{1}{4}$  inch or larger in diameter shall be of sufficient strength to support the piping, its contents and a load of 25 pounds per lineal foot of pipe length. Drain piping shall be considered as being full of water. Underground piers for pipe support shall be of concrete, masonry or pressure treated wood.

(b) *Compatability.* 1. Hangers and straps shall be of a material as to avoid galvanic action with the piping.

2. Hangers and straps shall not distort, cut or abrade piping and shall allow longitudinal free movement of the pipe.

(c) *Prohibited types.* Hangers, anchors and supports shall not be constructed of chain, rope, unbraided strands or plastic strap.

(2) **ATTACHMENT.** (a) Hangers and anchors shall be securely attached to the building's structure at intervals to support the piping and its contents.

(b) Hangers shall not be attached to a building's structure by means of wood plugs.

(3) **PIPE SUPPORT.** Pipe shall be supported at distances not to exceed those specified in Table 82.60.

**Table 82.60**  
**SUPPORT SPACING**

Pipe Material	Maximum Horizontal Spacing	Maximum Vertical Spacing
Cast iron	5'-0" or within 18" of each joint which is between lengths of pipe over 5'-0" long.	Each story height, but not to exceed 15'-0".
Steel and Brass	10'-0" for pipe ¾" or less in diameter. 12'-0" for pipe larger than ¾" in diameter.	Every other story height, but not to exceed 30'-0".
Copper	6'-0" for pipe 1¼" or less in diameter. 10'-0" for pipe larger than 1-¼".	Each story height, but not to exceed 10'-0".
Lead	Continuous support	4'-0"
Plastic	4'-0"	Each story height, but not to exceed 10'-0".
Borosilicate glass <sup>a</sup>	8'-0"	Each story height for pipe 3" or larger in diameter. Every other story height for pipe less than 3" in diameter.

Note a: Padded hangers shall be used.

History: Cr. Register, February, 1985, No. 350, eff. 3-1-85.

**ILHR 82****APPENDIX**

The material contained in this appendix is for clarification purposes only. The notes, illustrations, etc., are numbered to correspond to the number of the rule as it appears in the text of the code.

A-82.11 (29) Branch intervals.

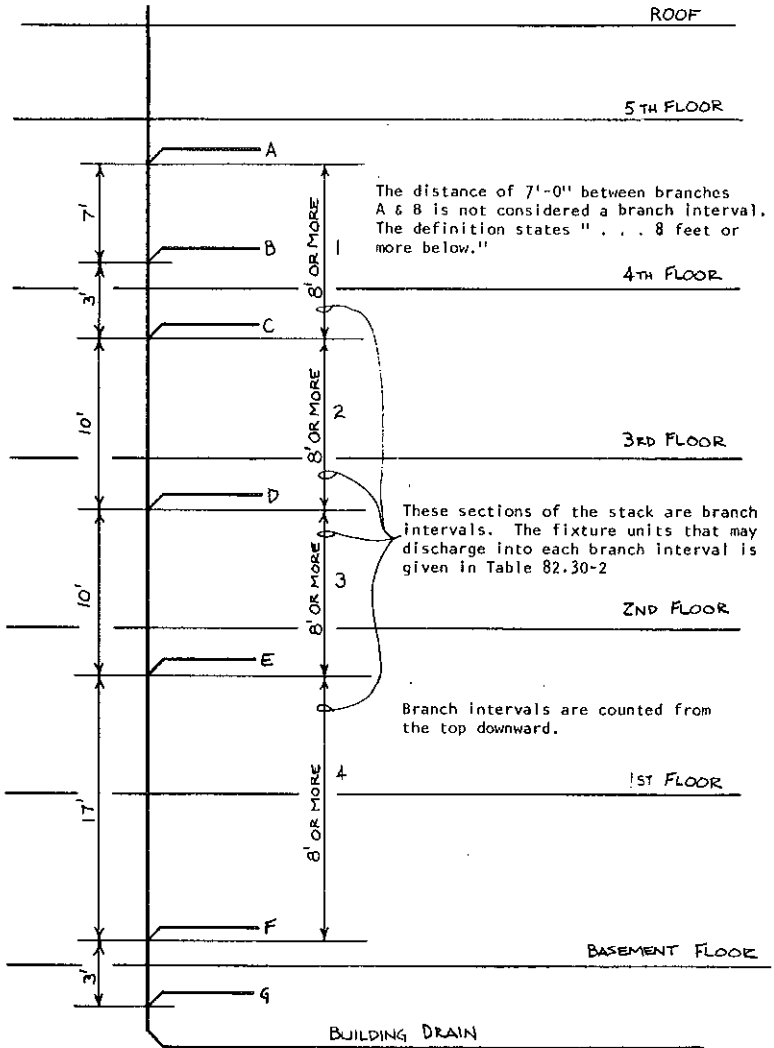



A-82.11 (140) Springline of pipe.

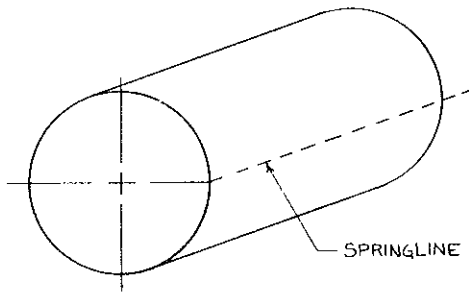

On a round pipe the springline is along the horizontal centerline.

A-82.20 and A-82.21 FORMS. The following forms (DILHR SBD-6154, 6677, 6099, 6690, 6212, 6479, 6192, 6114, 6155, and 7278) are used by the department in administration of this administrative code. Copies of these forms are available from the Division of Safety and Buildings, Plumbing Bureau, P.O. Box 7969, Madison, Wisconsin 53707.

INDUSTRY, LABOR AND HUMAN RELATIONS 165  
ILHR 82

A-82.20-82.21 FORMS. The following forms are referred to in ss. ILHR 82.20 and 82.21. Copies of the forms are available from the Bureau of Plumbing, P.O. Box 7969, Madison, Wisconsin 53707.



**GENERAL PLUMBING  
PLAN APPROVAL APPLICATION**

STATE OF WISCONSIN DILHR  
DIVISION OF SAFETY & BUILDINGS  
BUREAU OF PLUMBING  
201 E. Washington Avenue, Rm 141  
P.O. Box 3969, Madison, WI 53707  
608-266-3815

INSTRUCTIONS: Fill in all applicable data. This form is required with each general plumbing plan submittal. Examination fees, as determined on this form, shall accompany plan submittal. Data required in submittal is described on back side of this form.

1. PROJECT INFORMATION (Type or print clearly)			Date Submitted:		
Name of Submitting Party (Plans returned to same)			Project Name		
Street & No.			Project Location - Street & No. or Legal Description		
City	State	Zip	City	County	
			Village <input type="checkbox"/> OF		
			Town		
Telephone No. (Include area code)			Designer (Plumber)		Telephone No. (Include area code)
2. PLANS FOR			Owners Name		
<input type="checkbox"/> New Building <input type="checkbox"/> Addition <input type="checkbox"/> Remodel			Telephone No. (Include area code)		
<input type="checkbox"/> Revision to plumbing plan No. _____			Street & No.		
2a. Fee For Revisions - \$20.00			City	State	Zip

3. THIS APPLICATION IS FOR:		4. FEE SUBMITTED		FOR OFFICE USE ONLY
Check Appropriate Boxes)		(Indicate Charge For Remodeling Fees)		
3a.	<input type="checkbox"/> Sanitary Building Sewer, Drain, Waste & Vent	Sum of San. Sewer Diameters _____ Inches x \$20.00 =	4a.	_____
3b.	<input type="checkbox"/> Sanitary Building Sewer Only (No drain waste & vent)	Sum of San. Sewer Diameters _____ Inches x \$10.00 =	4b.	_____
3c.	<input type="checkbox"/> Building Water Distribution System (No water distribution system)	Sum of Water Service Diameters _____ Inches x \$20.00 =	4c.	_____
3d.	<input type="checkbox"/> Building Water Service Only	Sum of Water Service Diameters _____ Inches x \$10.00 =	4d.	_____
3e.	<input type="checkbox"/> Building Storm Sewer and Drainage System	Sum of Storm Sewer Diameters _____ Inches x \$4.00 =	4e.	_____
3f.	<input type="checkbox"/> Private Interceptor Main Sewer	Sum of Largest Diameters _____ Inches x \$9.00 =	4f.	_____
3g.	<input type="checkbox"/> Private Water Main	Number of Water Main Systems _____ x \$35.00 =	4g.	_____
3h.	<input type="checkbox"/> Concrete Roof Drainage System	\$30.00 Required	4h.	_____
3i.	<input type="checkbox"/> Petition for Variance (must be submitted on form # DILHR-SBD-6690)	\$100.00 =	4i.	_____
3j.	<input type="checkbox"/> Reduced Pressure Zone Principle			
	Type Backflow Preventer	Number of Valves _____ x \$35.00 =	4j.	_____
3k.	<input type="checkbox"/> Turf Sprinkler System	Number of Turf Sprinkler Systems _____ x \$30.00 =	4k.	_____
	Mobile Home Parks	1 - 25 Sites \$155.00 26 - 50 Sites \$210.00	4l.	_____
		51 - 125 Sites \$270.00 Over 125 Sites \$325.00		
3m.	<input type="checkbox"/> Manufactured Homes, Each Model	Number of Models _____ x \$250.00 =	4m.	_____
		SUBTOTAL =		
3n.	<input type="checkbox"/> Priority Plan Review (Walk-Thru)	Enter Same Amount as Subtotal	4n.	_____
		TOTAL FEE =		

5. ENCLOSURES

Enclosed  Under separate cover, please find the following

Two  Three sets of plans and  One set of Specifications

Check Number \_\_\_\_\_ In the amount of \_\_\_\_\_ Written by \_\_\_\_\_

**MAKE ALL CHECKS PAYABLE TO DILHR, BUREAU OF PLUMBING.**

6. REDUCED PRESSURE ZONE TYPE BACKFLOW PREVENTER DATA.

Indicate Valve Size, Manufacturer, Model No. or Location in Building (Room No., etc.) for each valve.

1. \_\_\_\_\_

2. \_\_\_\_\_

3. \_\_\_\_\_

4. \_\_\_\_\_

Use Additional Sheet if Needed. **Note: Fees pursuant to Wis. Adm. Code, Chapter Ind. 69 may be subject to change annually Effective July 1, 1984**

DILHR 580-6154 (R 3/84)

7. PLAN SUBMITTAL SHALL INCLUDE THE FOLLOWING IN ACCORD WITH CODE SECTION ILHR 82.25.

- A. One complete set of plans and specifications with one additional copy of plumbing drawings.
- B. Plans shall include:
1. Plot plan showing sewer and water.
  2. Floor plan showing building drain, water distribution mains and all fixtures and equipment to be installed.
  3. Riser diagrams of waste, vent and water distribution, with pipe sizes and fixture unit loads shown.
  4. Complete water calculations in accord with s. ILHR 82.13(4)(a).
  5. Remodeling or additions shall include existing loads.
  6. Plans including common ownership plumbing systems must be accompanied by form #OILHR SBD-7066.

B. EXAMINATION FEES FOR ADDITIONS AND REMODELLING.

When new or relocated fixtures or both are connected to the existing piping inside a building the fee shall be determined in accordance with the following procedures:

A. "Sanitary Building Sewer, Drain, Waste and Vent."

1. Total all of the drainage fixture units that are being added or relocated.
2. Refer to s. ILHR 82.03(3) Table 2, Wis. Adm. Code, and determine the horizontal drain size that would be required if all new or relocated fixtures discharged through one pipe.

Note: Disregard the asterisk limitation regarding 6 or 8 fixture unit pipe size. This pipe size is used for determining the fee only and does not necessarily mean this pipe size is used in actual design or installation.

3. Determine fee based on Table 69.23-1 1.

B. "Building Water Distribution System."

1. Total all of the water supply fixture units that are being added or relocated, using s. ILHR 82.13 Table 13, Wis. Adm. Code, and convert to gallons per minute (GPM) in accordance with s. ILHR 82.13 Table 14, Wis. Adm. Code.

2. The fees shall be determined in accordance with the GPM demand of the new or relocated fixtures as specified in Table 69.23-2.

Table 69.23-2

GPM	FEE
6	\$10.00
12	\$15.00
21	\$20.00
31	\$25.00
46	\$30.00
77	\$40.00
119	\$50.00
170	\$60.00
298	\$80.00

C. "Building Storm Sewer and Drainage System."

1. Total all of the roof area that the new or relocated roof drains serve. For added or relocated clear water drains inside the building receiving continuous or semi-continuous discharge into the building storm drain, each gallon per minute (GPM) of discharge shall be computed as 26 square feet of roof area.

2. Refer to s. ILHR 82.12 Table 11, Wis. Adm. Code, the column for "i" pitch, and determine the horizontal drain size that would be required if all new or relocated fixtures discharged through one pipe. Use this pipe size for determining the fee.

3. Determine the fee based on Table 69.23-1 5.

SRD 6677 (1/84) (Plb 100)

Detach And Return Upper Portion Of This Form With Any Return Correspondence



STATE OF WISCONSIN DILHR DIVISION OF SAFETY & BUILDINGS BUREAU OF PLUMBING 201 E. WASHINGTON AVE. RM 141 P.O. BOX 7969 MADISON, WI 53707 608-266-3815

DATE:

PROJECT:

[Empty box for date]

[Empty box for project name]

PLAN ID. #

DETACH HERE

PROJECT NAME \_\_\_\_\_ PLAN ID. # \_\_\_\_\_

This is to acknowledge receipt of your plans and specifications for the above-indicated project.

Preliminary review indicates the required fee is \$ \_\_\_\_\_ Fee received is \$ \_\_\_\_\_

- Underpayment, Overpayment, Plan accepted for review, No fee has been remitted, Additional information required.

I. Plan Submission

- One complete set of plans and specifications with an additional copy of plumbing drawings, One additional copy of plumbing drawings required, Plans shall be sealed or stamped, Wisconsin Administrative Code, Affidavit Sent, Additional information requested shall be sealed, stamped or signed, All information requested below shall be submitted in duplicate unless specifically noted below, Plans not clear, legible or permanent, Common ownership agreement.

- Capacity of pumps, Capacity of storage tank, Method of draining system, Provide riser, details and isometric diagrams, Indicate method of backflow protection.

IV. Reduced Pressure Zone - Type Backflow Preventer

- Valve size, model number and manufacturer, Elevation and location of valve in building, Detailed piping diagrams, Flow rate, Location of drain to receive discharge from device, Signed service agreement between owner and certified tester.

II. Building Sewers - Building Drains - Drain Waste & Vent

- Plot plan showing building sewer, Floor plan showing building drain, Statistics shown on risers or isometric diagrams, Pitch, Elevation of sewer with terrain elevations, Sewer access location, Venting, Traps, Materials and specifications, Manufacturer and model number of dental units, Ejector size and specifications, Detail of bar waste, Grease interceptor and sink compartment sizes.

V. Private Interceptor Main Sewer (sanitary and/or storm)

- Materials and specifications, Flow calculations, Elevation of sewer and manhole flow lines, Finish grade contours or profile of system.

VI. Sewage Grinder Pumps

- Manufacturer and/or model number of pump and/or basin, Elevation of building drain and main sewer, Location of grinder pump, Relative location to any nearby water line, Cross section of sump showing pumps.

III. Water Supply, Distribution and Service

- Plot plan showing water service, Floor plan showing water distribution system, Statistics for sizing, Materials and specifications, Pressure at public supply or supply tank.

VII. Pre-Fabricated Units

- Model number or specific name of unit and/or plbg. tree, Manufacturer's catalog of waste and water pipe and fittings with waste fitting radii listed, Detailed waste and water piping diagrams identifying every fitting with it's manufacturer's I.D. number.



**PLAN APPROVAL**

- General Plumbing Plans
- Private Sewage Plans

Safety and Buildings Division  
Bureau of Plumbing  
P.O. Box 7969  
Madison, WI 53707  
Telephone: (608)266-3815

<b>OFFICE USE ONLY</b>
Plan Identification No.
Gallons Per Day

<b>PRIORITY PLAN REVIEW ONLY</b>
Plan Review
\$
Petition For Modification
\$

Project Name		Project Location - Street No. or Legal Description	
City	Village	Town of	County

SAMPLE

The plumbing plans and specifications for this project have been reviewed for compliance with applicable code requirements. This approval is based on Chapter 145, Wisconsin Statutes and the Wisconsin Administrative Code. The plans are stamped "conditionally approved". This approval is contingent upon compliance with any stipulations shown on the plans. All items that are noted must be corrected. All permits required by the city, village, township or county shall be obtained prior to construction. The licensed plumber responsible for this installation shall keep one set of plans with the department's approval stamp at the construction site. The installer shall notify the appropriate inspector when inspections can be made.

**FOR GENERAL PLUMBING PLANS:**

This approval will expire two years from the date approved below. If construction has not commenced before the expiration date, new plan approval must be obtained.

**FOR PRIVATE SEWAGE PLANS:**

This approval will expire two years from the date approved below or if a sanitary permit is obtained, it will expire the day the initial sanitary permit expires.

Comments:

By:

*James Sargent*  
James Sargent  
Bureau Director

If Questions Contact	Plans Approved By:	Date Approved
----------------------	--------------------	---------------

- |                                   |                                   |   |
|-----------------------------------|-----------------------------------|---|
| cc: <input type="checkbox"/> OWS  | <input type="checkbox"/> DPS      | <input type="checkbox"/> H&R & Rec. San. Section            |
| <input type="checkbox"/> County   | <input type="checkbox"/> Local Pl | <input type="checkbox"/> Facilities Street Analysis Section |
| <input type="checkbox"/> UW-SSW&P | <input type="checkbox"/> Plumber  | <input type="checkbox"/> Department of Agriculture          |
| <input type="checkbox"/> Owner    | <input type="checkbox"/> Other    |   |

DLHR 510 (2/77) (R) 01/85

Petition for Modification of an Administrative Rule PLUMBING FEE \$ _____	<b>WISCONSIN DEPARTMENT OF          INDUSTRY, LABOR AND HUMAN RELATIONS          DIVISION OF SAFETY &amp; BUILDINGS          P.O. BOX 7969, MADISON, WI 53707</b>	OFFICE USE ONLY _____
		Petition No. _____
		E.No. _____
		ID No. _____

Name of Owner	Building Occupancy or Use	Agent, Architect or Engineering Firm or Master Plumber
Company	Tenant Name, if any	
Street & No.	Building Location, Street & No.	Street & No.
City State & Zip	City County	City State & Zip
Phone	Plan Numbers (if known)	Phone

**WISCONSIN ADMINISTRATIVE RULE BEING PETITIONED**

1. Rule \_\_\_\_\_ of the Wisconsin Administrative code cannot be entirely satisfied due to the following reasons:

-----  
 -----  
 -----  
 -----  
 -----

2. In lieu of complying exactly with the rule, the following alternative is proposed as a means of providing an equivalent degree of safety or health:

-----  
 -----  
 -----  
 -----  
 -----

3. Supporting arguments (If necessary, use back side of form to provide a detailed drawing):

-----  
 -----  
 -----  
 -----  
 -----

**SAMPLE**

<b>DETAILED PLAN OR DRAWING</b>														
SAMPLE														
<b>PLUMBING INSPECTOR AUTHORIZATION</b>		Ref: _____ being petitioned												
On-site inspection conducted (date) _____														
I, _____ indicate the information recorded on this request form is accurate and correct to the best of my knowledge and belief.														
Comments (prior const): _____														
<b>VERIFICATION BY OWNER--PETITION IS VALID ONLY IF NOTARIZED</b> <small>FOR INFORMATION CONTACT THE DEPARTMENT AT (608) 266-3915</small>														
_____ being duly sworn, says he is petitioner herein, thus he has read the foregoing petition and that the same is true, as he verily believes.														
_____ <small>Signature of Owner</small>	<table border="1" style="width: 100%; border-collapse: collapse;"> <tr> <th colspan="3" style="text-align: left; padding: 2px;">OFFICE USE ONLY</th> </tr> <tr> <td style="width: 33%; padding: 2px;">Date Received</td> <td style="width: 33%; padding: 2px;">Amount Paid</td> <td style="width: 33%; padding: 2px;">Receipt No.</td> </tr> <tr> <td colspan="3" style="padding: 2px;">Department Action</td> </tr> <tr> <td style="padding: 2px;">Administrative</td> <td colspan="2" style="padding: 2px;">Date</td> </tr> </table>		OFFICE USE ONLY			Date Received	Amount Paid	Receipt No.	Department Action			Administrative	Date	
OFFICE USE ONLY														
Date Received	Amount Paid	Receipt No.												
Department Action														
Administrative	Date													
Subscribed and sworn to me this _____ day of 19 _____														
_____ County, Wisconsin.														
_____ <small>Notary Public</small>														
My commission expires: _____														





State of Wisconsin \ Department of Industry, Labor and Human Relations

DATE: \_\_\_\_\_

SAFETY & BUILDINGS DIVISION

Bureau of Plumbing  
201 East Washington Avenue  
P.O. Box 7969  
Madison, Wisconsin 53707

\_\_\_\_\_  
\_\_\_\_\_  
\_\_\_\_\_

Plan Identification No. \_\_\_\_\_

Re: \_\_\_\_\_

\_\_\_\_\_  
\_\_\_\_\_  
\_\_\_\_\_

Plans and specifications have been received and assigned the above plan identification number. Preliminary review of these plans indicate the plans have not been sealed or stamped in accord with section ILHR 82.20 or s. ILHR 83.08 (2) (a), Wisconsin Administrative Code.

Rather than return the plans at this time, please have the party preparing the plans sign the affidavit below and return to this office.

AFFIDAVIT

I, the undersigned, hereby certify that the plans and specifications submitted and assigned the above plan identification number were prepared by or under my direction and control.

NAME \_\_\_\_\_  
(type or print)

REGISTRATION NUMBER \_\_\_\_\_ OR MASTER PLUMBER LICENSE NO. \_\_\_\_\_

ADDRESS \_\_\_\_\_

SIGNATURE \_\_\_\_\_ DATE \_\_\_\_\_

DTLHR SBD-6212 (R.11/83)

WATER CALCULATION WORKSHEET

Information Needed for Water Service Sizing

- 1) \_\_\_\_\_ Demand of building in G.P.M.
- 2) \_\_\_\_\_ Low pressure at main in street (or at external pressure tank).
- 3) \_\_\_\_\_ Difference in elevation. Main to meter (or external pressure tank to building control valve).
- 4) \_\_\_\_\_ Size of water meter (if applicable).
- 5) \_\_\_\_\_ Developed length from main to meter (or external pressure tank to building control valve).

Your First Goal is to Find the Available Pressure After the Water Meter (or at building control valve). To obtain this, you must

- 1) \_\_\_\_\_ Find pressure loss due to friction in water service.  
 Example: Demand of the building is 20 G.P.M. and we want to use type "K" copper for the water service. We think 3" service is necessary. Look at "K" copper table and follow 20 G.P.M. horizontally to the 3" line. Look straight down to find pressure loss per 100' which is approximately 17 p.s.i. On this building service is 120' long. The formula for finding the pressure loss thru service is:  

$$\frac{17}{100} = \frac{X}{120}$$

$$X = \text{Pressure loss thru service. You must cross multiply and divide, } 17 \times 120 \div 100 = 20 \text{ p.s.i. loss due to friction.}$$
- 2) \_\_\_\_\_ Find pressure loss due to elevation, main to meter (or external pressure tank to building control valve) multiply difference in elevation by .434.
- 3) \_\_\_\_\_ Find pressure loss due to meter. (from manufacturer, AWWA, or Water Distribution Manual).
- 4) \_\_\_\_\_ Subtract the loss due to friction (Step 1), loss due to elevation (Step 2), and loss due to meter (Step 3) from the low street pressure (or low pressure at external pressure tank). This gives you available pressure after the water meter (or at the building control valve).

Information Needed for Water Distribution Sizing

Using the following formula, find permissible uniform pressure loss for friction (p.s.i./100' of pipe)

$$A = \frac{B - (C + D + E) \times 100}{F}$$

WHERE:

- A. \_\_\_\_\_ Permissible uniform pressure loss for friction. (p.s.i./100' of pipe).
- B. \_\_\_\_\_ Available pressure after water meter (at the building control valve or low pressure at internal pressure tank).
- C. \_\_\_\_\_ Pressure needed at controlling fixture.
- D. \_\_\_\_\_ Difference in elevation between water meter (building control valve or internal pressure tank) and controlling fixture in feet \_\_\_\_\_ x .434.
- E. \_\_\_\_\_ Pressure loss due to heater (3 p.s.i.), softener, etc.
- F. \_\_\_\_\_ Total length between water meter (building control valve or internal pressure tank) and controlling fixture in feet \_\_\_\_\_ x 1.5.

With permissible uniform pressure loss, go to applicable table for distribution sizing.

DILHR-SBD-6479 (R. 11/83)

PLB-1

INSPECTION REPORT

Wisconsin Department of Industry,  
Labor & Human Relations  
Safety & Buildings Division  
Bureau of Plumbing

Name of Premises		Date	Plan I.D. No.
Street	City	County	Sanitary Permit #
Master Plumber & Firm Name		Address	
Journeyman Plumber		Address	
Owner		Address	

**SAMPLE**

Discussed with	Signature
----------------	-----------

( ) See Attached.

DILHR-SBD-6192 (R. 11/83)

Signature of Dist. Plumbing Sup. On-Site Waste Specialist



Bureau of Plumbing  
201 East Washington Avenue  
P.O. Box 7969  
Madison, WI 53707

ATTENTION

NOTICE OF INSTALLATION

The enclosed plans for the reduced pressure zone principle type backflow preventer(s) have been approved by the department. Before the unit is installed, this form must be completed by the plumber making the installation. Return completed form to the Bureau of Plumbing, P.O. Box 7969, Madison, Wisconsin 53707. FAILURE TO DO SO CANCELS THE APPROVAL FOR INSTALLATION.

PLAN IDENTIFICATION NO: \_\_\_\_\_ DATE OF INSTALLATION: \_\_\_\_\_

NAME AND ADDRESS OF PROJECT: \_\_\_\_\_  
\_\_\_\_\_  
\_\_\_\_\_

MAKE	SIZE	SERIAL NUMBER	LOCATION IN BUILDING
------	------	---------------	----------------------

**SAMPLE**

NAME AND ADDRESS OF INSTALLER: \_\_\_\_\_  
\_\_\_\_\_  
\_\_\_\_\_

DILHR 580-7278 (N.05/84)

(Reduced Pressure Zone Principle Type Backflow Preventers)  
 FILL OUT THIS FORM COMPLETELY

DEPARTMENT OF INDUSTRY, LABOR AND HUMAN RELATIONS  
 Division of Safety and Buildings  
 Bureau of Plumbing

MONTH \_\_\_\_\_ YEAR \_\_\_\_\_

MANUFACTURER \_\_\_\_\_ MODEL \_\_\_\_\_ SIZE \_\_\_\_\_ SERIAL # \_\_\_\_\_

NAME OF PROJECT \_\_\_\_\_ COUNTY \_\_\_\_\_

ADDRESS \_\_\_\_\_  
 (Street) (City) (Zip)

LOCATION OF DEVICE  
 IN BUILDING \_\_\_\_\_

MONTHLY REPORT	EVIDENCE OF LEAKAGE DIFFERENTIAL RELIEF VALVE		WEEKLY INSPECTION LOG
1st WEEK	IN OPERATION	YES _____ NO _____	INSPECTION BY _____
	LEAKAGE	YES _____ NO _____	DATE _____
	REPAIRS	YES _____ NO _____	REPAIRED BY _____
2nd WEEK	IN OPERATION	YES _____ NO _____	INSPECTION BY _____
	LEAKAGE	YES _____ NO _____	DATE _____
	REPAIRS	YES _____ NO _____	REPAIRED BY _____
3rd WEEK	IN OPERATION	YES _____ NO _____	INSPECTION BY _____
	LEAKAGE	YES _____ NO _____	DATE _____
	REPAIRS	YES _____ NO _____	REPAIRED BY _____
4th WEEK	IN OPERATION	YES _____ NO _____	INSPECTION BY _____
	LEAKAGE	YES _____ NO _____	DATE _____
	REPAIRS	YES _____ NO _____	REPAIRED BY _____
5th WEEK	IN OPERATION	YES _____ NO _____	INSPECTION BY _____
	LEAKAGE	YES _____ NO _____	DATE _____
	REPAIRS	YES _____ NO _____	REPAIRED BY _____

THE ABOVE REPORT IS CERTIFIED TO BE TRUE

BY \_\_\_\_\_ REPRESENTING (CO.) \_\_\_\_\_

DATE \_\_\_\_\_ RETURN ADDRESS: NAME \_\_\_\_\_

STREET \_\_\_\_\_

CITY \_\_\_\_\_ STATE \_\_\_\_\_ ZIP \_\_\_\_\_

SEE REVERSE

DILHR SBD-6114 (R. 03/82)

# INDUSTRY, LABOR AND HUMAN RELATIONS

177

ILHR 82

FILL OUT THIS FORM COMPLETELY AND RETURN TO:  
 DEPARTMENT OF INDUSTRY, LABOR AND HUMAN RELATIONS  
 DIVISION OF SAFETY AND BUILDINGS, BUREAU OF PLUMBING  
 P.O. BOX 7960, MADISON, WI 53707

REDUCED PRESSURE BACKFLOW PREVENTER ANNUAL TEST REPORT

MANUFACTURER \_\_\_\_\_ MODEL \_\_\_\_\_ SIZE \_\_\_\_\_ SERIAL NUMBER \_\_\_\_\_

NAME OF PROJECT \_\_\_\_\_ COUNTY \_\_\_\_\_

ADDRESS (street, city, zip) \_\_\_\_\_

LOCATION OF DEVICE IN BUILDING \_\_\_\_\_

	CHECK VALVE #1	CHECK VALVE #2	DIFFERENTIAL PRESSURE RELIEF VALVE	COMMENTS
ANNUAL TEST	1. LEAKED <input type="checkbox"/> 2. CLOSED TIGHT <input type="checkbox"/>	1. LEAKY <input type="checkbox"/> 2. CLOSED TIGHT <input type="checkbox"/>	OPENED AT _____ LBS. REDUCED PRESSURE.  DID NOT OPEN <input type="checkbox"/>	
R E P A I R S	7/8" <input type="checkbox"/> 1" <input type="checkbox"/> 1 1/8" <input type="checkbox"/> 1 1/2" <input type="checkbox"/> 2" <input type="checkbox"/> 2 1/2" <input type="checkbox"/> 3" <input type="checkbox"/> 4" <input type="checkbox"/> 5" <input type="checkbox"/> 6" <input type="checkbox"/> OTHER, DESCRIBE <input type="checkbox"/>	CLEANED <input type="checkbox"/> REPLACED: <input type="checkbox"/> DISC <input type="checkbox"/> SPRING <input type="checkbox"/> GUIDE <input type="checkbox"/> PIN RETAINER <input type="checkbox"/> HINGE PIN <input type="checkbox"/> SEAT <input type="checkbox"/> DIAPHRAGM <input type="checkbox"/> OTHER, DESCRIBE <input type="checkbox"/>	CLEANED <input type="checkbox"/> REPLACED: <input type="checkbox"/> DISC <input type="checkbox"/> UPPER <input type="checkbox"/> LOWER <input type="checkbox"/> SPRING <input type="checkbox"/> DIAPHRAGM: <input type="checkbox"/> LARGE: <input type="checkbox"/> UPPER <input type="checkbox"/> LOWER <input type="checkbox"/> SMALL <input type="checkbox"/> SEAT: <input type="checkbox"/> UPPER <input type="checkbox"/> LOWER <input type="checkbox"/> SPACER: <input type="checkbox"/> LOWER <input type="checkbox"/> OTHER, DESCRIBE <input type="checkbox"/>	
FINAL TEST	CLOSED TIGHT <input type="checkbox"/>	CLOSED TIGHT <input type="checkbox"/>	OPENED AT _____ LBS. REDUCED PRESSURE	

THE ABOVE REPORT IS CERTIFIED TO BE TRUE. CERTIFICATION # \_\_\_\_\_

INITIAL TEST BY \_\_\_\_\_ REPRESENTING (CO.) \_\_\_\_\_ DATE 

MO.	DAY	YR.
-----	-----	-----

REPAIRED BY \_\_\_\_\_ DATE \_\_\_\_\_

FINAL TEST BY \_\_\_\_\_ REPRESENTING (CO.) \_\_\_\_\_ DATE 

MO.	DAY	YR.
-----	-----	-----

SBD-6115 (R.06/82)

A-82.20 (2) AGENT MUNICIPALITIES. The department has designated to the following municipalities, the authority to review and approve plumbing plans and specifications for those plumbing installations to be located within the municipality's boundary limits and which require approval under s. ILHR 82.20 (1) (b).

Appleton	Kenosha	Muskego
Beloit	Madison	Oconomowoc
Eau Claire	Manitowoc	Oshkosh
Green Bay	Mequon	Racine
Greenfield	Milwaukee	Two Rivers

A-82.20 (4) The following is a list of Designated Management Agencies and the counties they serve.

DESIGNATED MANAGEMENT AGENCY:	COUNTIES SERVED
Harlan P. Kiesow, Clearing House Review Coordinator East Central Wisconsin Regional Planning Commission 140 Main Street Menasha, WI 54952 (414) 729-1100	Menominee, Shawano, Waupaca, Outagamie, Waushara, Marquette, Green Lake, Winnebago, Calumet, Fond du Lac
William N. Lane Director, Environmental Resources Planning Dane County Regional Planning Commission Room 523, City County Building Madison, WI 53709 (608) 266-4417	Dane
Patrick M. Vaile, Senior Planner Brown County Planning Commission Room 608, City Hall 100 North Jefferson Street Green Bay, WI 54301 (414) 497-3633	Brown
Kurt W. Bauer, Executive Director Southeastern Wisconsin Regional Planning Commission 916 North East Avenue P.O. Box 769 Waukesha, WI 53187-1607 (414) 547-6721	Washington, Ozaukee, Waukesha, Milwaukee, Walworth, Racine, Kenosha

The following is a list of Sewer Service Area Plans approved by the Department of Natural Resources. For each Sewer Service Area Plan the approved Planning Agency and affected communities are shown.

CONTACTS - SEWER SERVICE AREA PLANS	AFFECTED COMMUNITIES
<u>Eau Claire - Chippewa Falls</u>	
Kevin Jones, Director West Central Wisconsin Regional Planning Commission 124 1 2 Graham Avenue Eau Claire, WI 54701 (715) 836-2918	City of Eau Claire City of Altoona City of Chippewa Falls Town of Hallie Town of Seymour Town of Union Town of Washington
<u>Hudson</u>	
Richard Thompson, County Planner St. Croix County Planning Office Courthouse Hudson, WI 54016 (715) 386-5581	City of Hudson Town of Hudson Town of St. Joseph Village of North Hudson Town of Troy

Stevens Point

Bill Burke or Chuck Kell  
Portage County Planning Department  
County - City Building  
1516 Church Street  
Stevens Point, WI 54481  
(715) 346-1334

City of Stevens Point  
Village of Whiting  
Village of Plover  
Village of Park Ridge  
Town of Hull  
Town of Plover  
Town of Linwood

Wausau

Joseph Pribanich  
Marathon County Regional Planning  
Commission  
Courthouse  
Forest Street  
Wausau, WI 54401  
(715) 847-5227

City of Wausau  
Village of Rothschild  
City of Schofield  
Town of Weston  
Town of Stettin  
Town of Rib Mountain  
Town of Kronenwetter

Wisconsin Rapids

Gary Popelka  
Office of County Planning  
Wood County Courthouse  
400 Market Street  
Wisconsin Rapids, WI 54494  
(715) 421-8466

City of Wisconsin Rapids  
Village of Biron  
Town of Grand Rapids  
Town of Rudolph  
Town of Sigel  
Town of Seneca  
Town of Grant

A-82.20 (8) FEES. The following reprint of s. Ind 69.23 (1) may be used to determine the amount of fee required for general plumbing plan review by the department.

Ind 69.23 Plumbing and private sewage systems. (1) PLUMBING PLAN EXAMINATION FEES. (a) *Applicability.* Plan examination fees for preliminary or complete plans shall accompany the plans and specifications when submitted. If the department determines upon review of the plans that inadequate fees were provided, the necessary additional fee shall be provided prior to departmental approval.

(b) *Examination fees.* The plan examination fee shall be determined in accordance with Table 69.23-1.

Table 69.23-1

Type of Review	Fee
1. Sanitary drain and vent system.....	\$ 20.00 per inch diameter of each bldg. sewer
2. Sanitary building sewer only, no drain and vent.....	\$ 10.00 per inch diameter of each bldg. sewer
3. Building water distribution system .....	\$ 20.00 per inch diameter of each water service
4. Building water service only, no water..... distribution system	\$ 10.00 per inch diameter of each water service
5. Building storm and clear water drain system .....	\$ 4.00 per inch diameter of each bldg. storm sewer
6. Sanitary private interceptor main sewers, .....	\$ 8.00 per inch diameter of each interceptor main sewer
7. Private water main .....	\$ 35.00
8. Controlled roof drainage system, does not.....	\$ 30.00 include building storm sewer
9. Reduced pressure zone principle type .....	\$ 35.00 backflow preventer
10. Turf sprinkler system.....	\$ 30.00



## ILHR 82

11. Mobile home parks:	
1-25 sites .....	\$155.00
26-50 sites .....	\$210.00
51-125 sites .....	\$270.00
Over 125 sites.....	\$335.00
12. Manufactured homes, each model .....	\$250.00

(c) *Examination fees for additions and remodeling.* When new or relocated fixtures or both are connected to the existing piping inside a building the fee shall be determined in accordance with the following procedures:

1. Sanitary building sewer, drain, waste and vent. a. Total all of the drainage fixture units that are being added or relocated.

b. Refer to s. ILHR 82.30 Table 82.30-2, and determine the horizontal drain size that would be required if all new or relocated fixtures discharged through one pipe.

Note: Disregard Note c limitation regarding water closets. This pipe size is used for determining the fee only and does not necessarily mean this pipe size is used in actual design or installation.

c. Determine fee based on Table 69.23-1 1.

2. Building water distribution system. a. Total all of the water supply fixture units that are being added or relocated, using s. ILHR 82.40 Table 13, and convert to gallons per minute (GPM) in accordance with s. ILHR 82.40 Table 14.

b. The fees shall be determined in accordance with GPM demand of the new or relocated fixtures as specified in Table 69.23-2.

Table 69.23-2

GPM	FEE
6.....	\$10.00
12.....	\$15.00
21.....	\$20.00
31.....	\$25.00
46.....	\$30.00
77.....	\$40.00
119.....	\$50.00
170.....	\$60.00
298.....	\$80.00

3. Building storm sewer and drainage system. a. Total all of the roof area that the new or relocated roof drains serve. For added or relocated clear water drains inside the building receiving continuous or semi-continuous discharge into the building storm drain, each gallon per minute (GPM) of discharge shall be computed as 26 square feet of roof area.

b. Refer to s. ILHR 82.36 Table 82.36-1, the column for 1/4" pitch, and determine the horizontal drain size that would be required if all new or relocated fixtures discharged through one pipe. Use this pipe size for determining the fee.

c. Determine the fee based on Table 69.23-1 5.

(d) *Priority plan review.* An appointment may be made with the department to facilitate the examination of plans in less than the normal processing time. The plans shall comply with the provisions of s. ILHR 82.20. Delivery of the plans for priority plan review shall be made in person. The fee for this type of plan examination shall be determined at twice the normal rate.

(e) *Reproduction fee.* If the correct number of plans or specifications have not been submitted, a minimum reproduction fee of \$7.00 per set shall be charged except that reproductions exceeding \$7.00 per set shall be charged actual costs. Reproduction fees shall be charged to the party submitting the plans.

(f) *Plan approval - additional copies.* Approval for sets of plans in excess of 3 sets shall be provided upon receipt of a fee of \$10.00 plus \$3.50 per plan sheet.

(g) *Revisions.* The fee for revisions to previously examined plans shall be \$20.00 per plan. This fee applies when plans are revised for reasons other than those that were requested by the department.

(h) *Projects without approval.* The fees specified in pars. (b) to (g) shall be doubled for those projects for which the installation of plumbing has started without department approval.

A-82.30 (4) The following tables lists the maximum GPM which can be expected to readily flow through a given size trap where the receptor has a height as indicated.

Also listed is a maximum drainage fixture unit load which a given size receptor trap may be expected to adequately receive.

Note: The department recommends an individual 4-inch diameter minimum trap and drain pipe for a commercial type dishwasher.

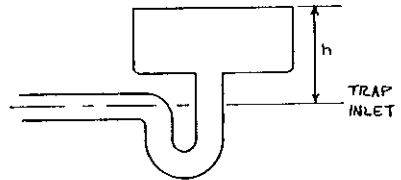
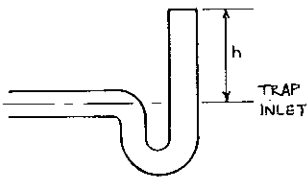

Receptor Trap size	H Height	GPM	d. f. u.
1-1/2"	12"	4	2
2"	14"	8	4
3"	15"	12	6
4"	17"	40	20
5"	20"	70	35
6"	22"	120	60
8"	25"	250	125

A-82.30 (4) (d) Minimum size of private interceptor main sewers.

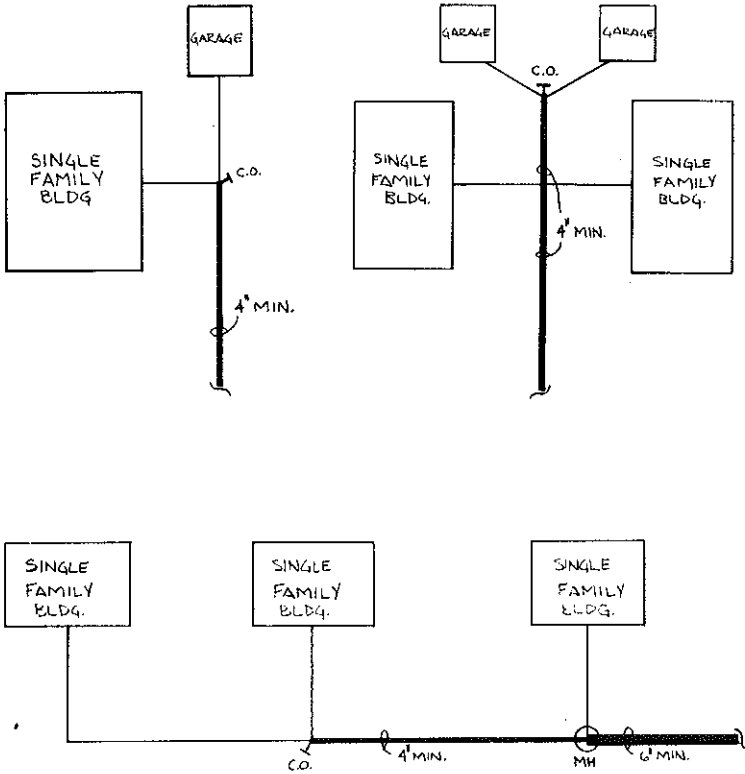

A-82.30 (4) (d) Minimum size of private interceptor main sewers.

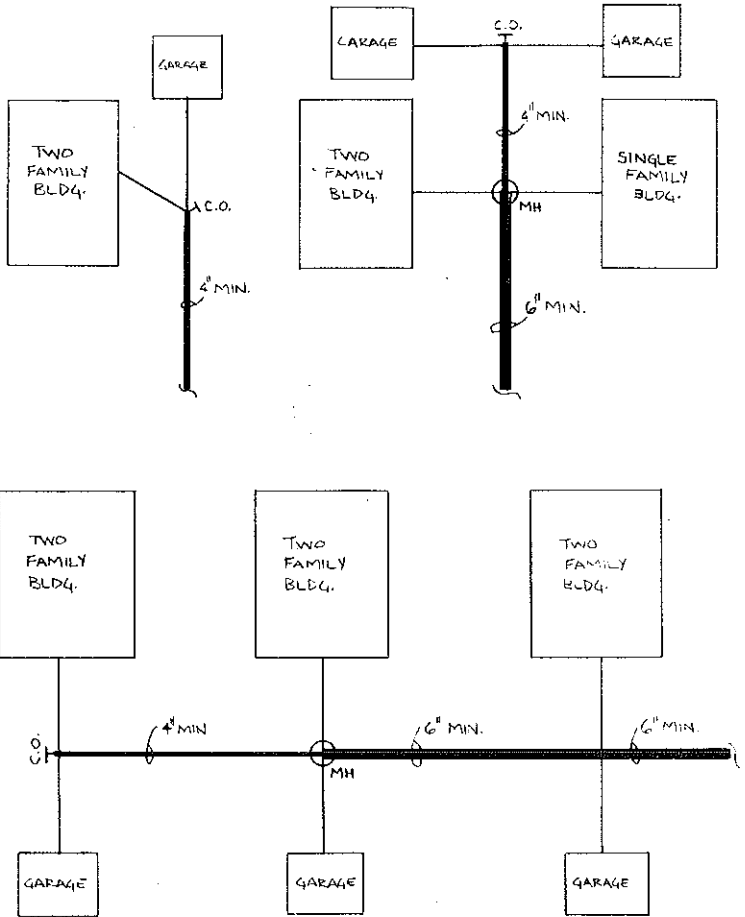

A-82.30 (6) (b) Offsets in vertical drains.

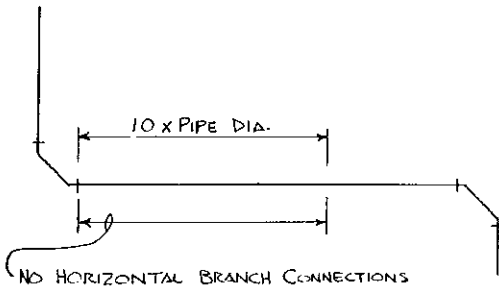
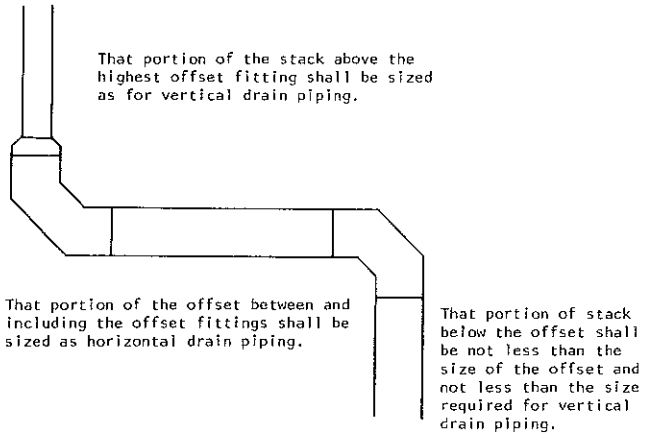

A-82.30 (7) Horizontal branch drain connection at base of a stack.

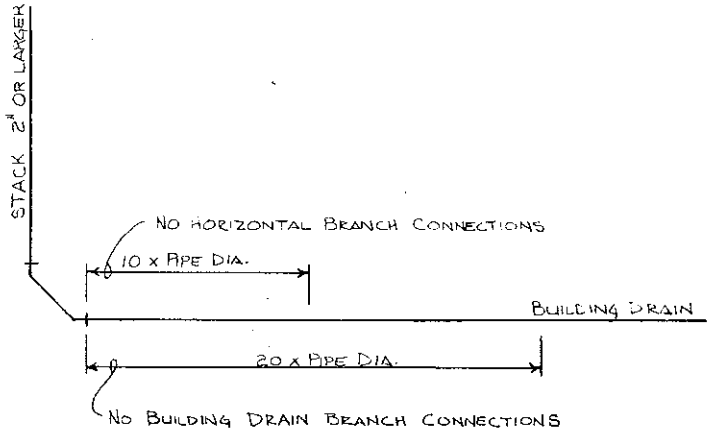

A-82.30 (8) Measuring radius of a fitting.

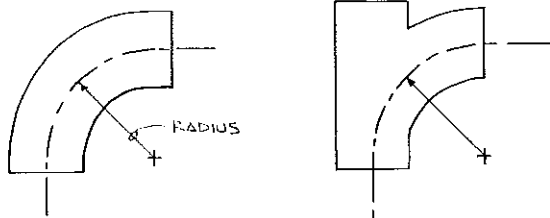

A-82.30 (9) Drain fittings and connections.

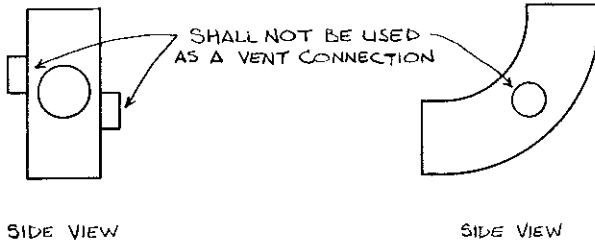

SIDE INLETS

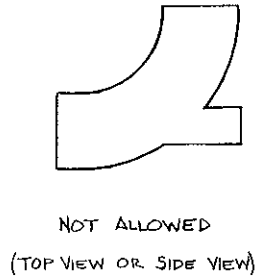
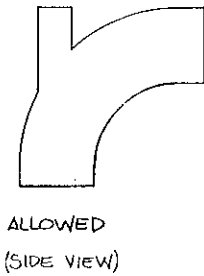

HEEL INLETS

A-82.30 (10) (a) Determining required capacity of sanitary sump.

SANITARY SUMP

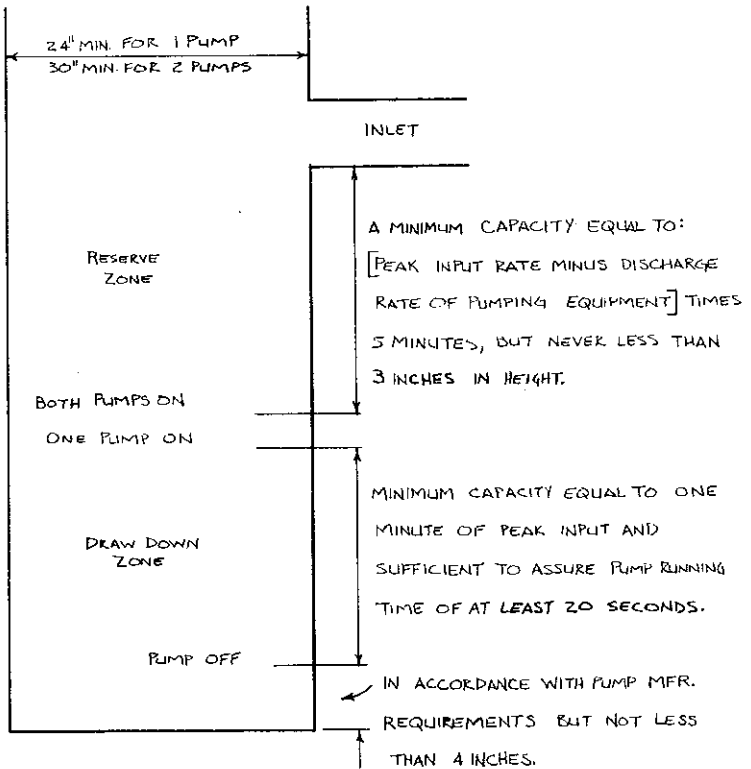



A-82.30 (10) (a)

Capacity of Sumps  
(in gallons)

Diameter of sump in inches	Volume in gal/ft	Diameter of sump in inches	Volume in gal/ft
24	23.5	41	68.6
25	25.5	42	72.1
26	27.6	43	75.5
27	29.7	44	79.1
28	32.0	45	82.7
29	34.3	46	86.5
30	36.8	47	90.2
31	39.2	48	94.0
32	41.8	54	119.0
33	44.5	60	147.0
34	47.2	66	178.0
35	50.0	72	211.5
36	52.8	78	248.4
37	55.9	84	288.1
38	59.0	90	330.8
39	62.1	96	376.3
40	65.3	108	477.3

A-82.30 (11) (a) Building drains serving any building.

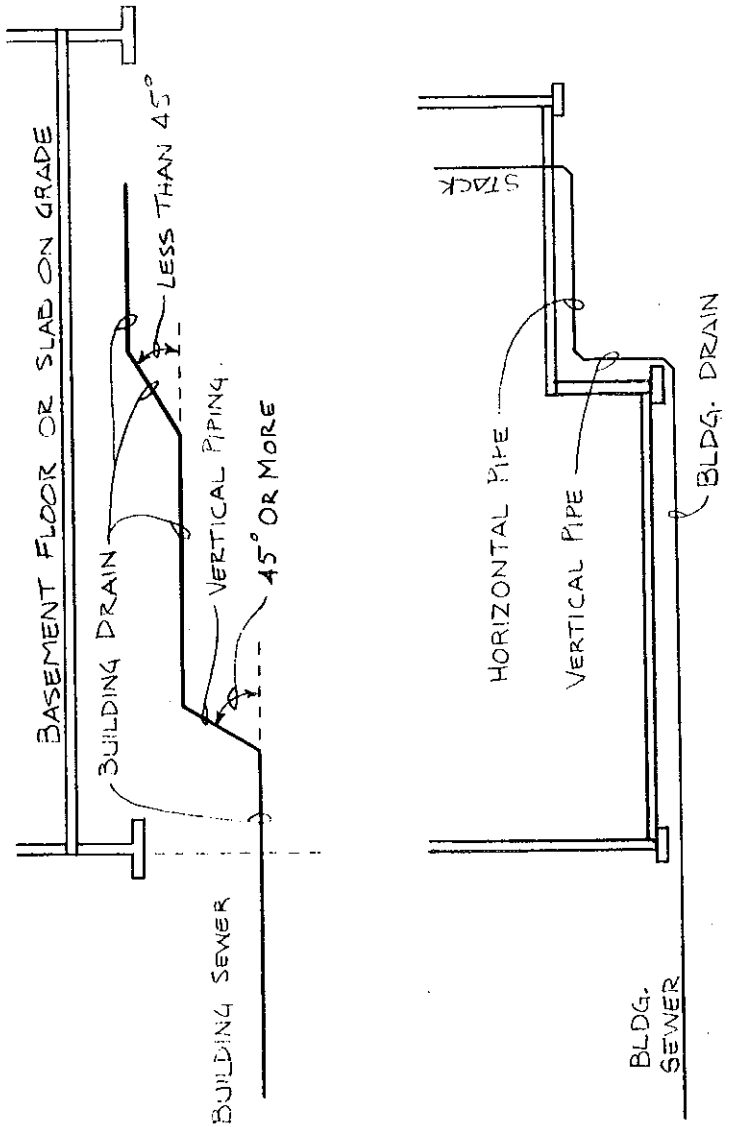

A-82.30 (11) (a) Building drains serving dwelling units.

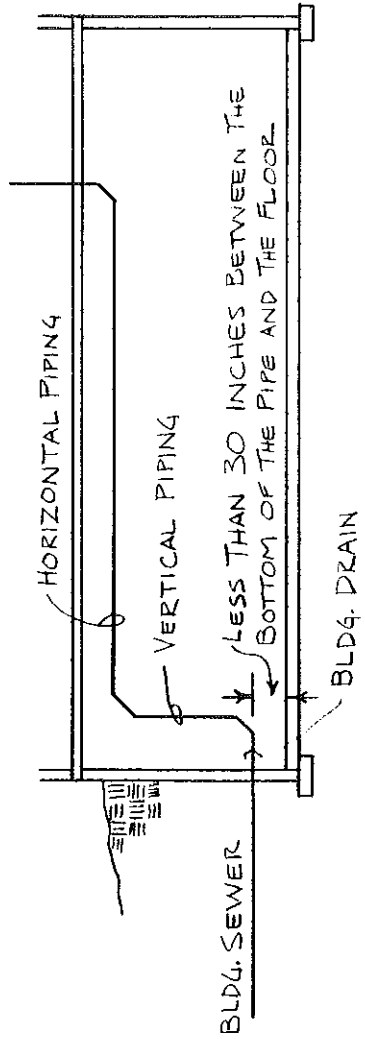
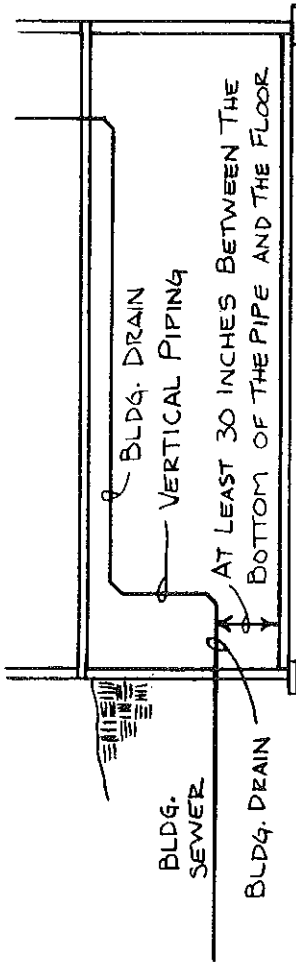

A-82.30 (11) (a) Floor drain required.

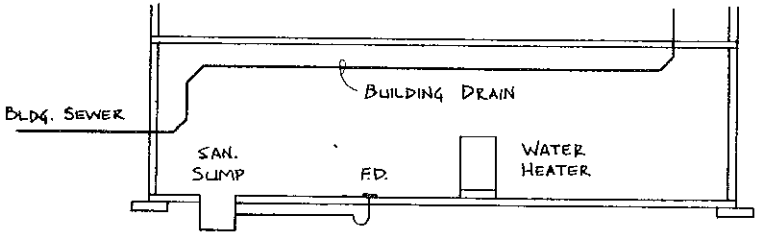

A-82.30 (11) (e) Connection to pressurized public sewer.

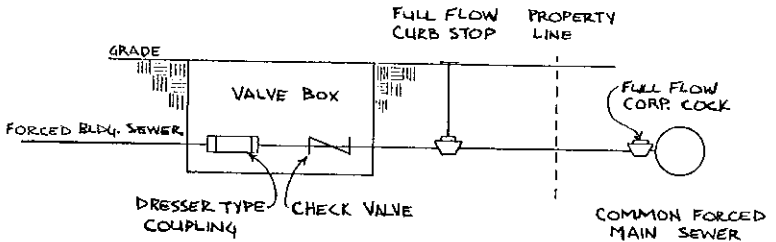

A-82.31 (4) (a) Where a vent stack and stack vent are required.

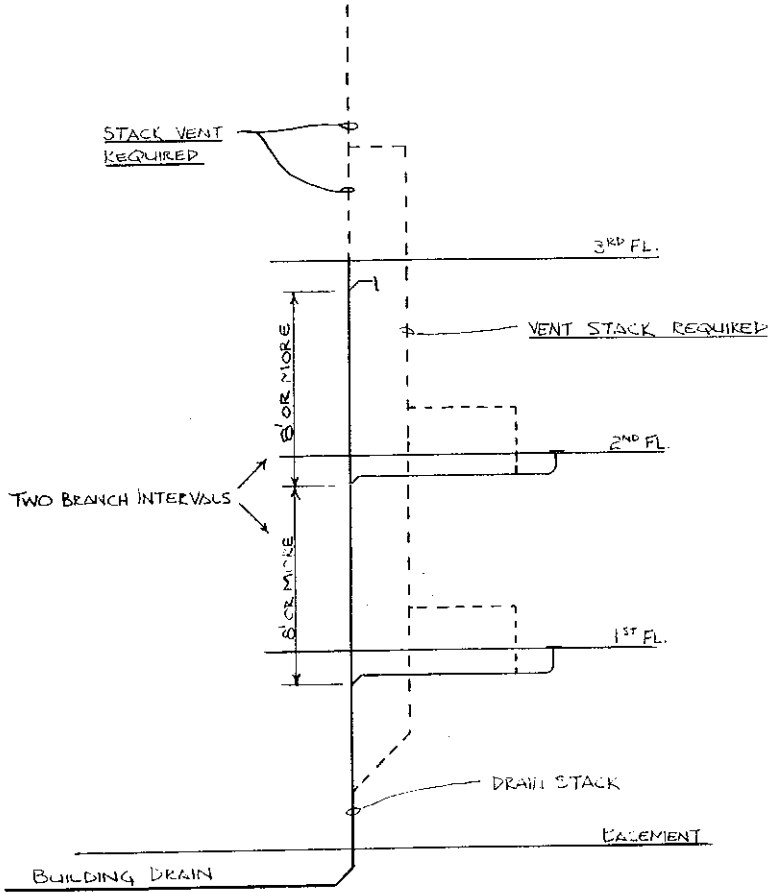

A-82.31 (4) (a) Where a vent stack and stack vent are not required.

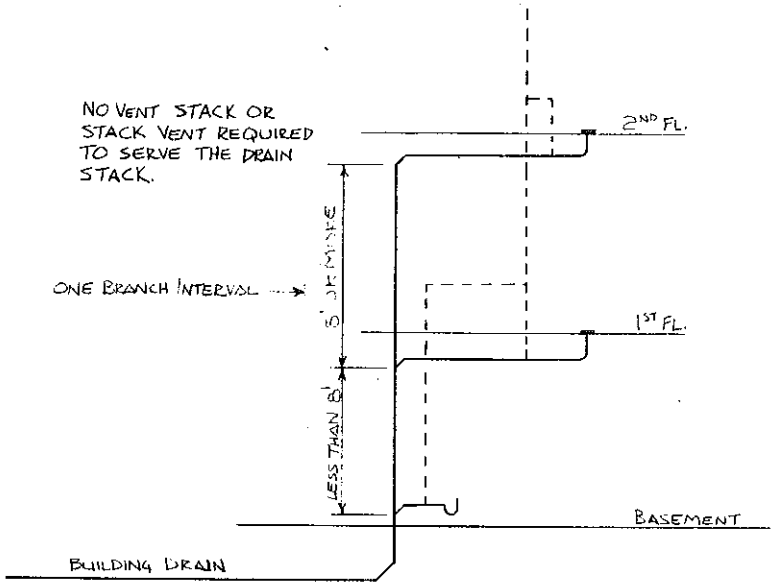

A-82.31 (4) (b) Installation of vent stack and stack vent.

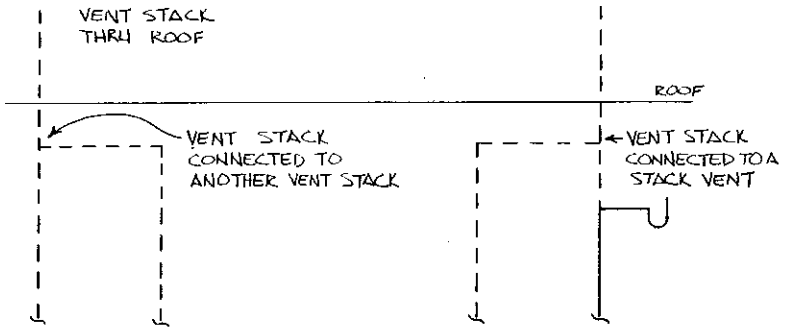
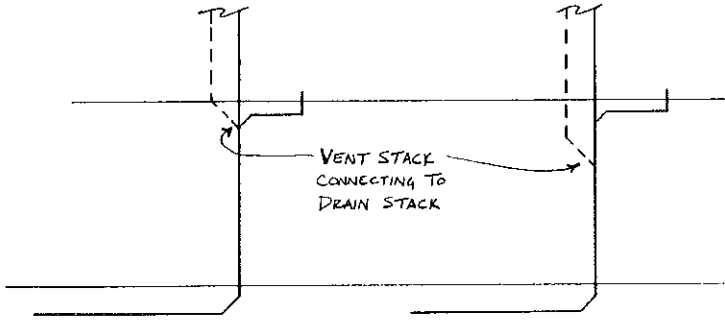

A-82.31 (4) (b) Installation of vent stack and stack vent.

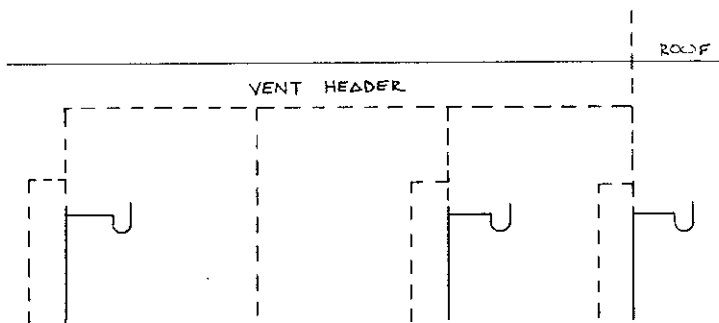



A-82.31 (5) (b) Relief vent for offsets of 30 to 45 degrees.

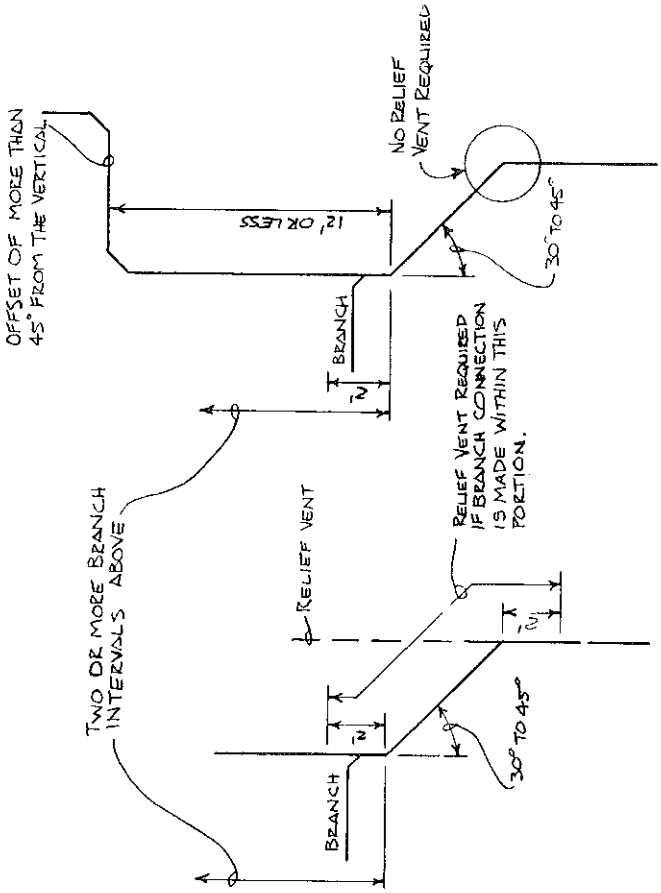

A-82.31 (5) (b) Relief and yoke vents for offsets of more than 45 degrees.

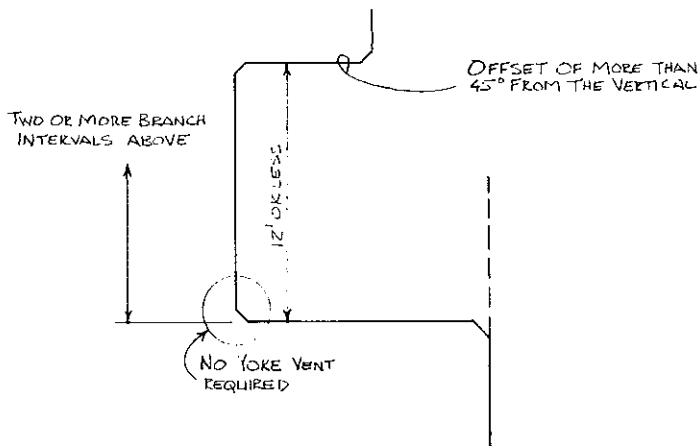
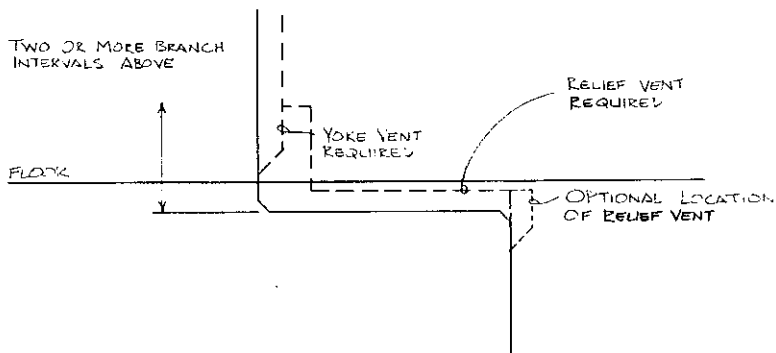

A-82.31 (7) Relief vents for building drains.

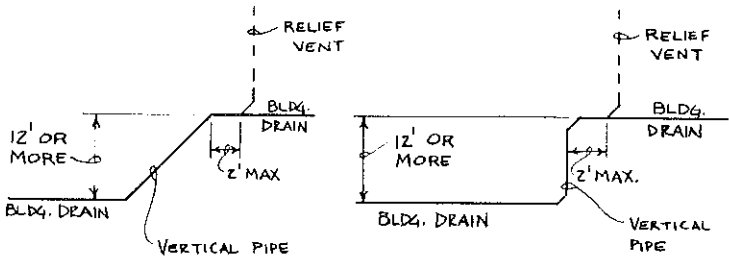

A-82.31 (9) Fixture vents.

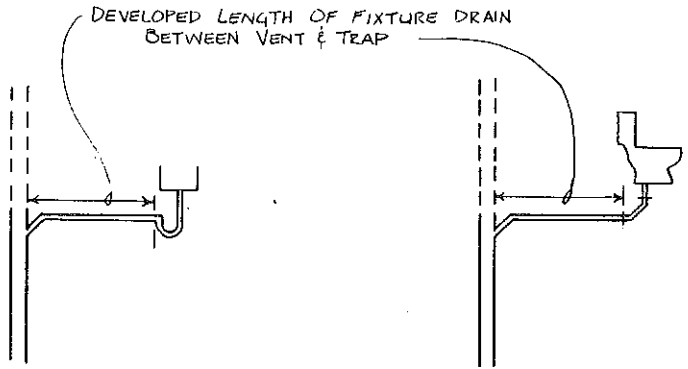

WHERE TRAP IS NOT AN INTEGRAL PART OF THE FIXTURE

WHERE TRAP IS AN INTEGRAL PART OF THE FIXTURE

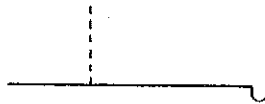

VENT CONNECTING TO HORIZONTAL DRAIN PIPING

VENT CONNECTING TO VERTICAL DRAIN PIPING

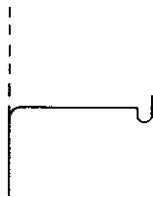

BY MEANS OF A SANITARY TEE FITTING

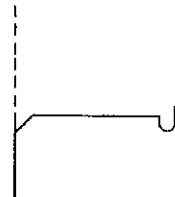

BY MEANS OF A WYE PATTERN FITTING

A-82.31 (10) Circuit venting.

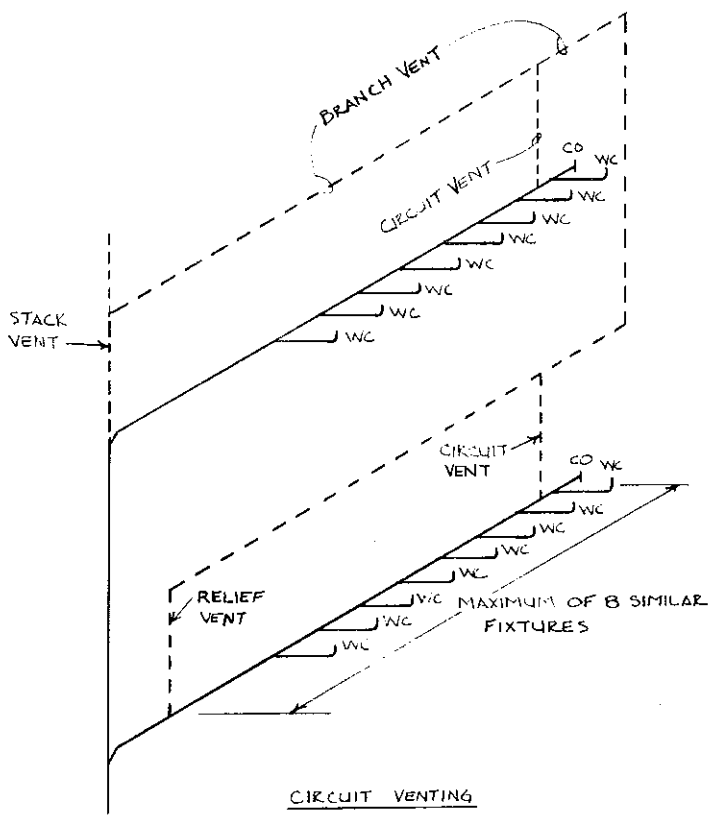

A-82.31 (10) Circuit venting.

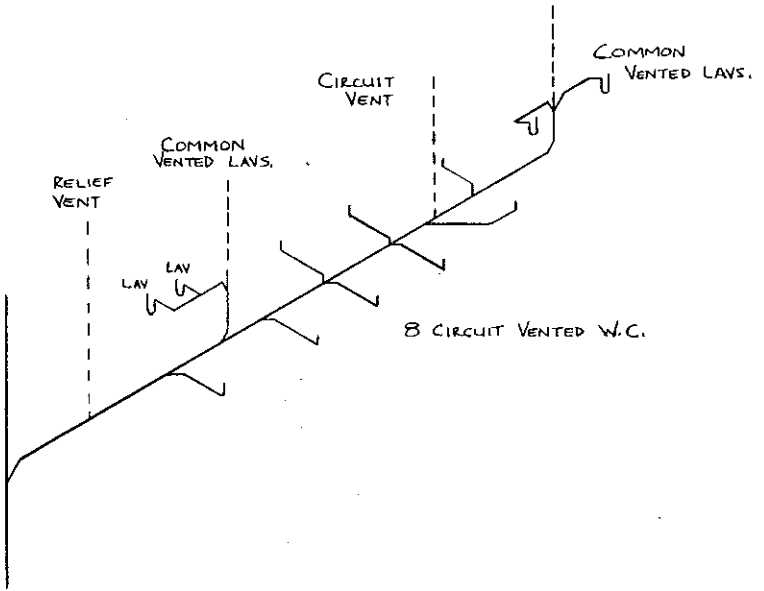

A-82.31 (10) Circuit venting.

NO  
FIXTURES  
ABOVE

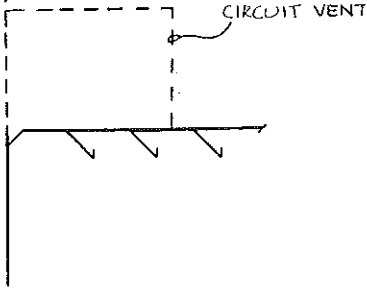

FIXTURES  
ABOVE

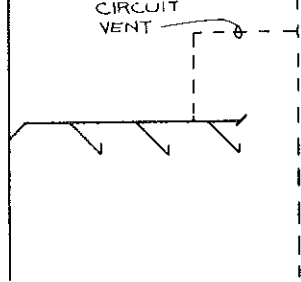

CIRCUIT VENTING  
3 FIXTURES

NO  
FIXTURES  
ABOVE

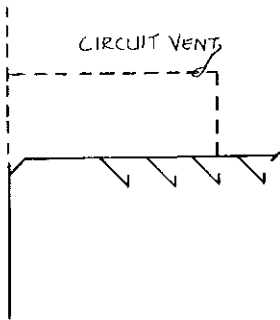

FIXTURES  
ABOVE

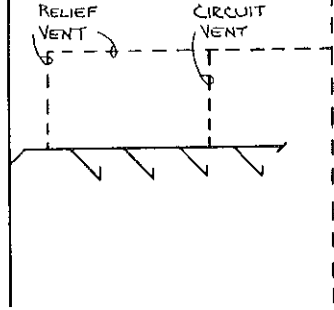

CIRCUIT VENTING 4 OR  
MORE FIXTURES

A-82.31 (10) Circuit venting.

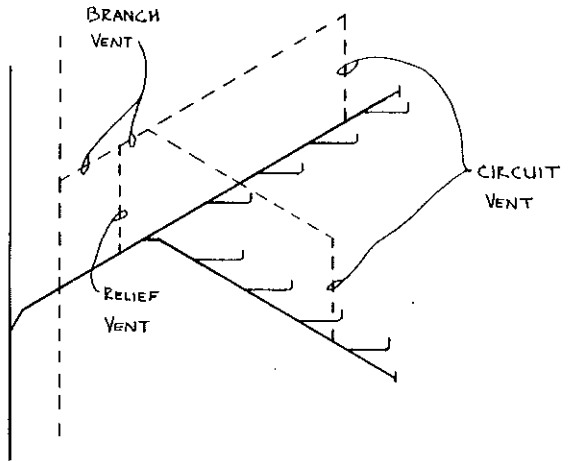
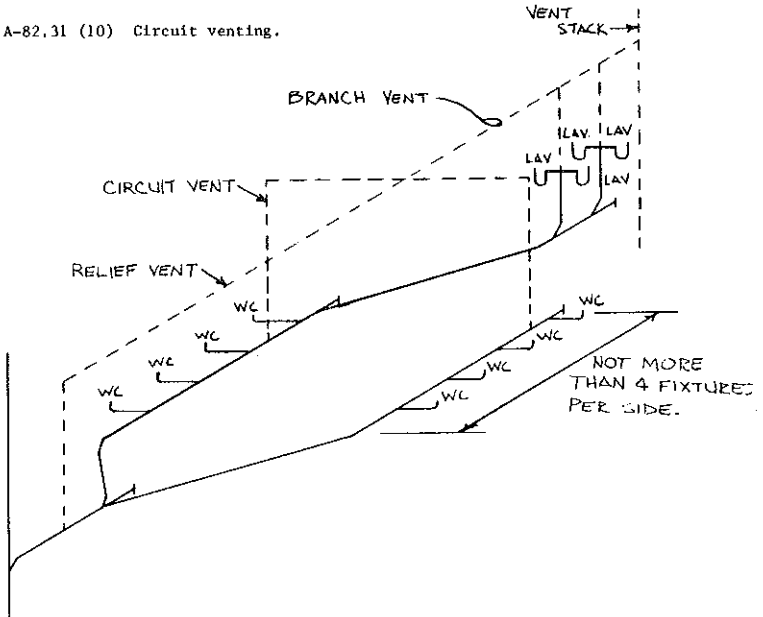



A-82.31 (11) (a) Common vents, vertical drains.

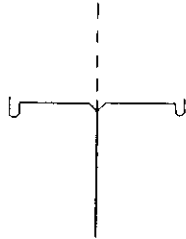

BACK-TO-BACK

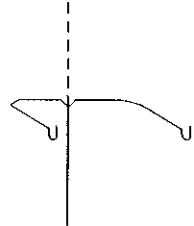

SIDE-BY-SIDE

COMMON VENT SERVING ANY TWO FIXTURES

A-82.31 (11) (b) Common vents, horizontal drains.

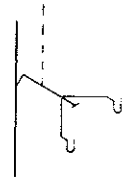
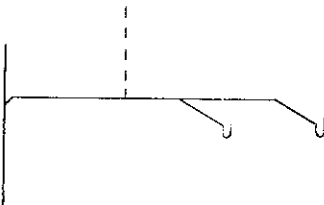
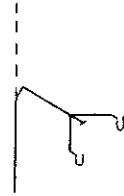
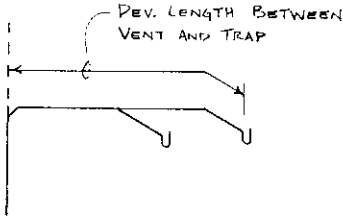

COMMON VENTS SERVING TWO LAVATORIES OR  
TWO COMPARTMENTS OF ONE KITCHEN SINK

A-82.31 (12) Island fixture venting.

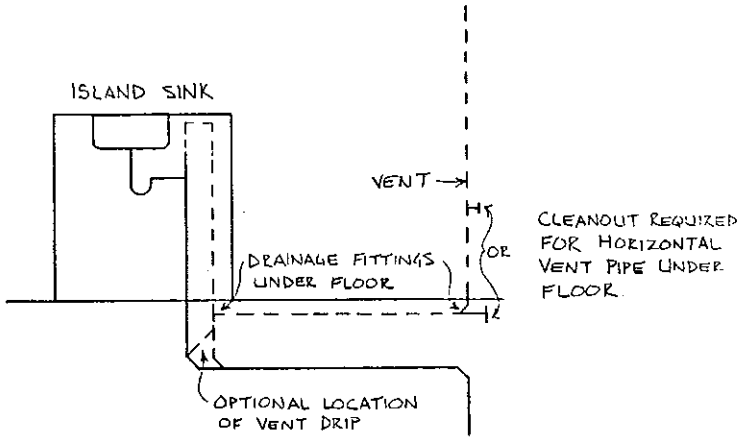

A-82.31 (13) (a) Vertical wet vents.

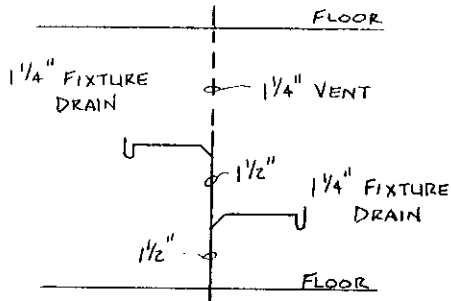
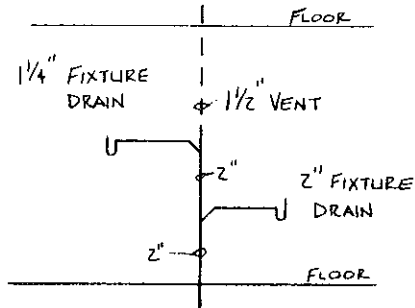

VERTICAL WET VENT

A-82.31 (13) (b) Horizontal wet vents.

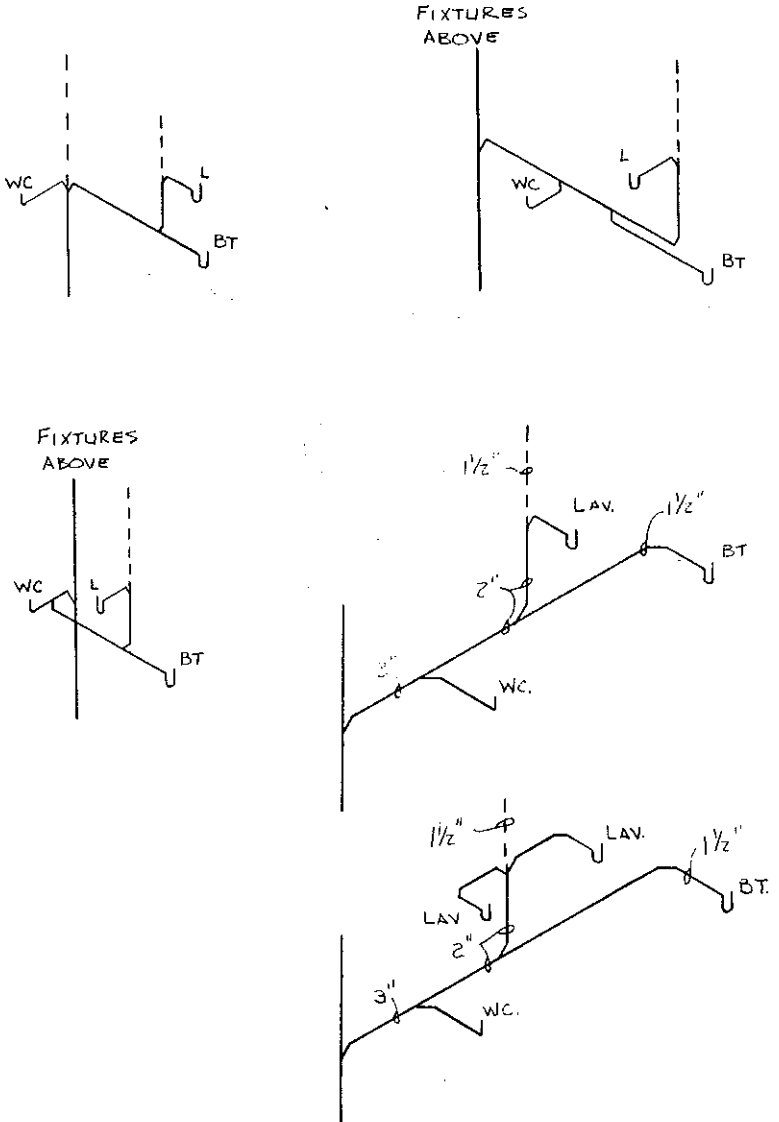

A-82.31 (13) (b) Horizontal wet vents.

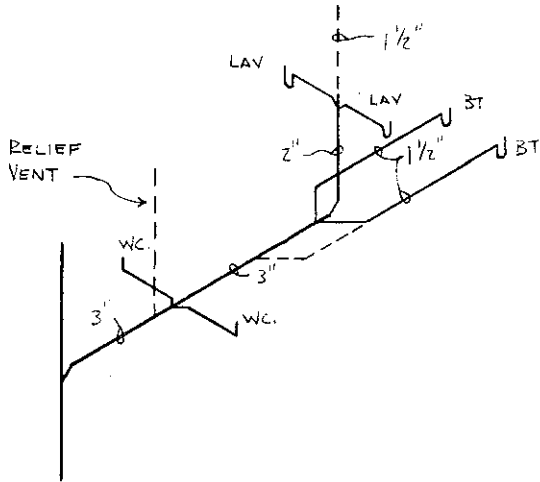

HORIZONTAL WET VENTS

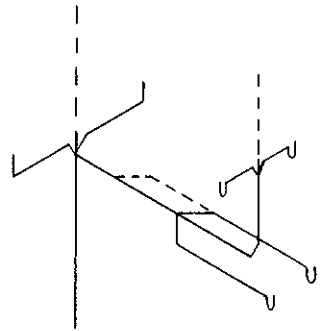

BACK-TO-BACK TOP FLOOR

A-82.31 (13) (c) Wet venting - floor outlet fixtures.

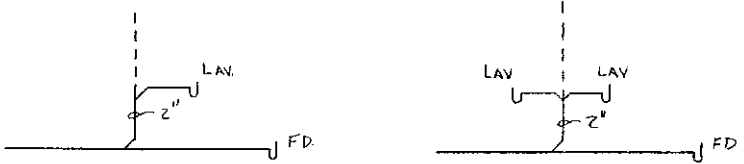

INDIVIDUAL VENT FOR FLOOR OUTLET FIXTURE  
SERVING AS A WET VENT

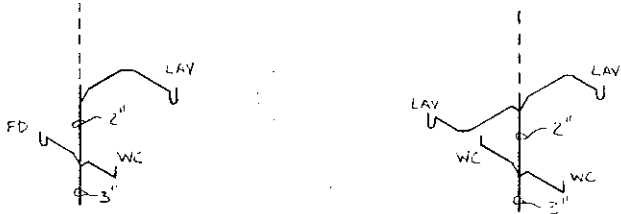

COMMON VENT FOR FLOOR OUTLET FIXTURES  
SERVING AS A WET VENT

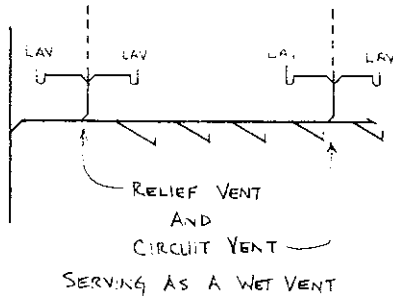

A-82.31 (14) (a) and (b) Sizing vent stacks and stack vents.

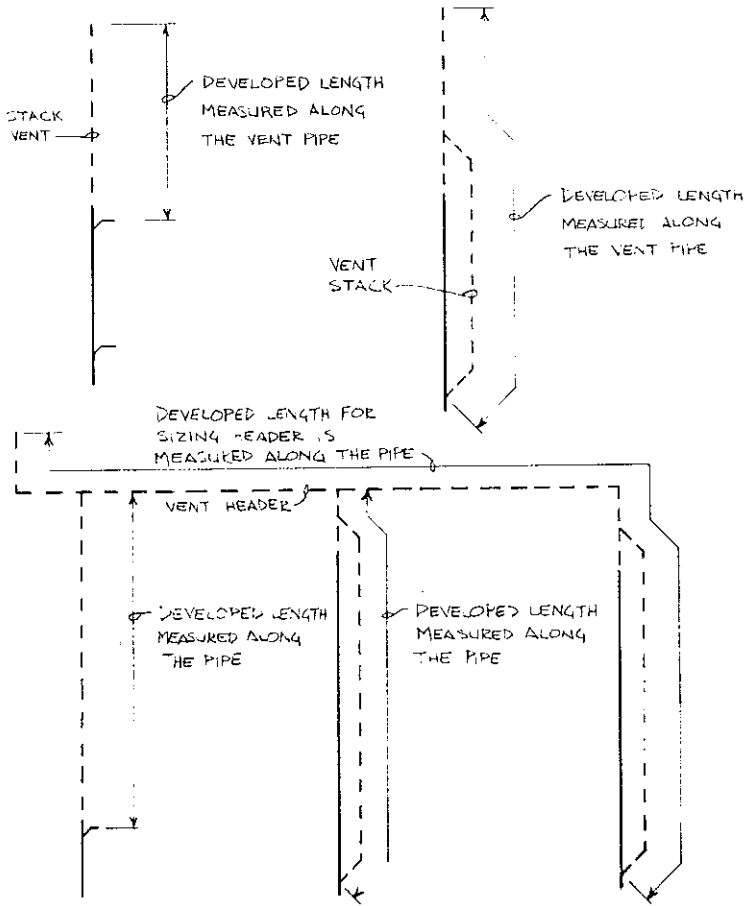

A-82.31 (14) (c) Sizing branch vents.

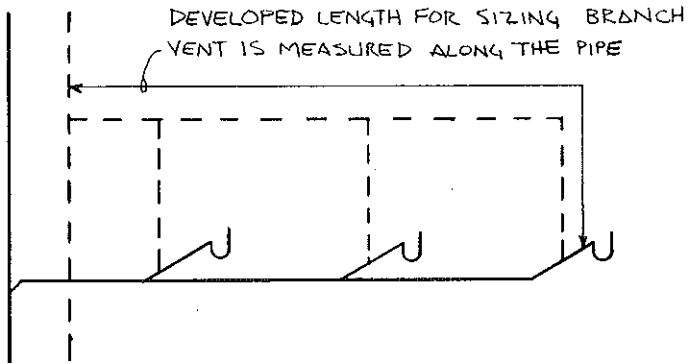

A-82.31 (14) (d) Sizing individual vents.

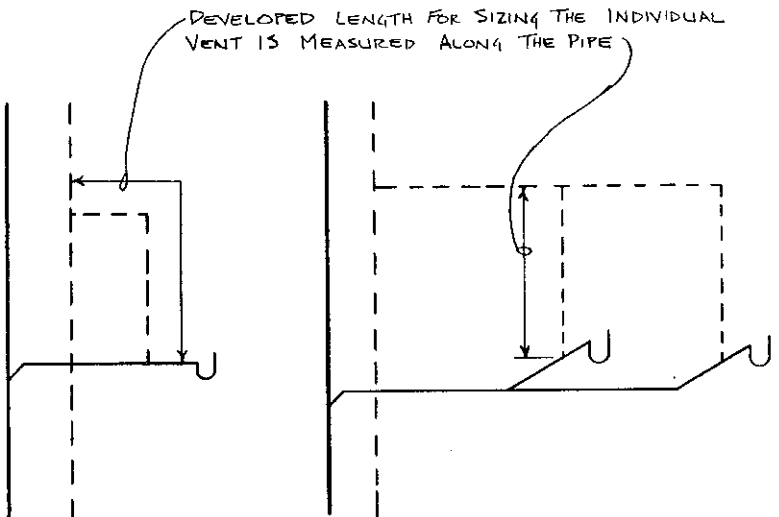



A-82.31 (14) (c) Sizing branch vents serving a wet vent.

WHEN SIZING THE BRANCH VENT, THE DEVELOPED LENGTH IS MEASURED ALONG THE VENT PIPE, INCLUDING THE WET VENT PORTION.

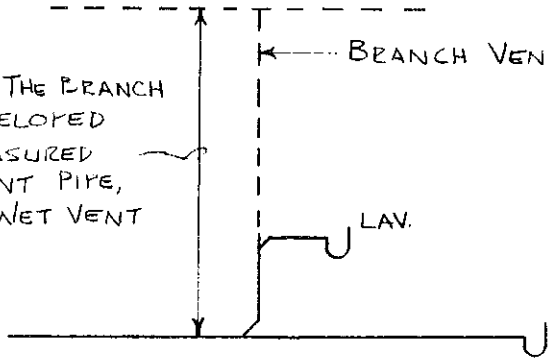

WHEN SIZING THE BRANCH VENT, THE DEVELOPED LENGTH IS MEASURED ALONG THE VENT PIPE, INCLUDING THE WET VENT PORTION.

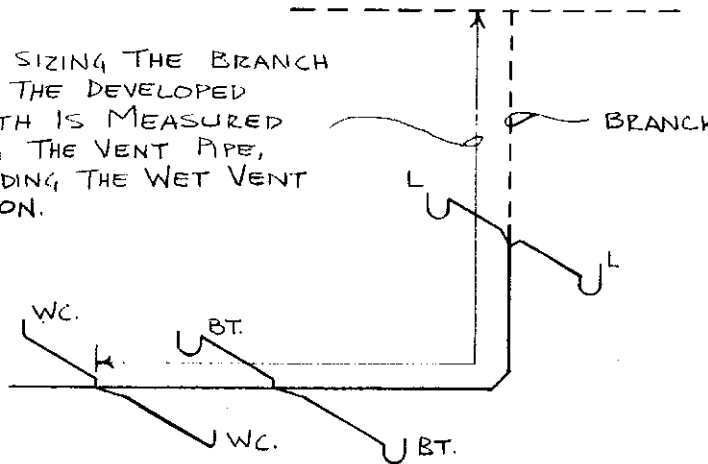

A-82.31 (15) (a) Vent grades and connections.

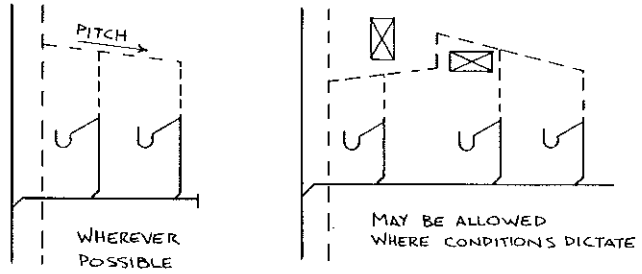

A-82.31 (15) (b) Vent grades and connections.

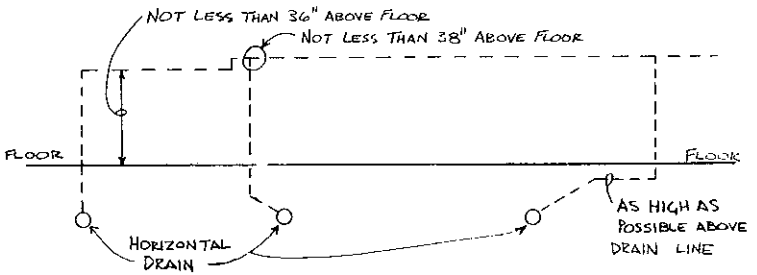

A-82.3i (16) Vent terminals.

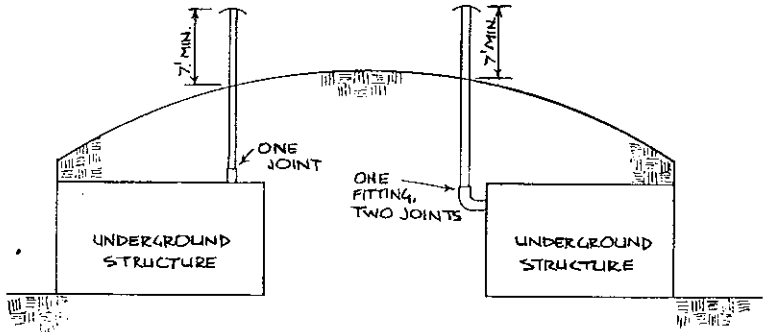
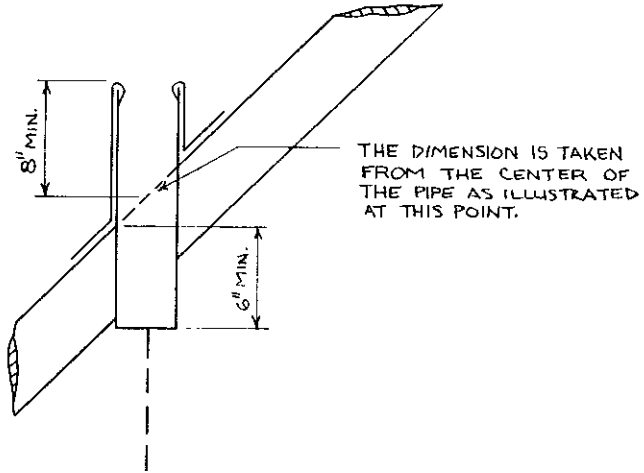

VENT TERMINALS FOR UNDERGROUND STRUCTURES

A-82.31 (17) (a) Combination drain and vent stacks.

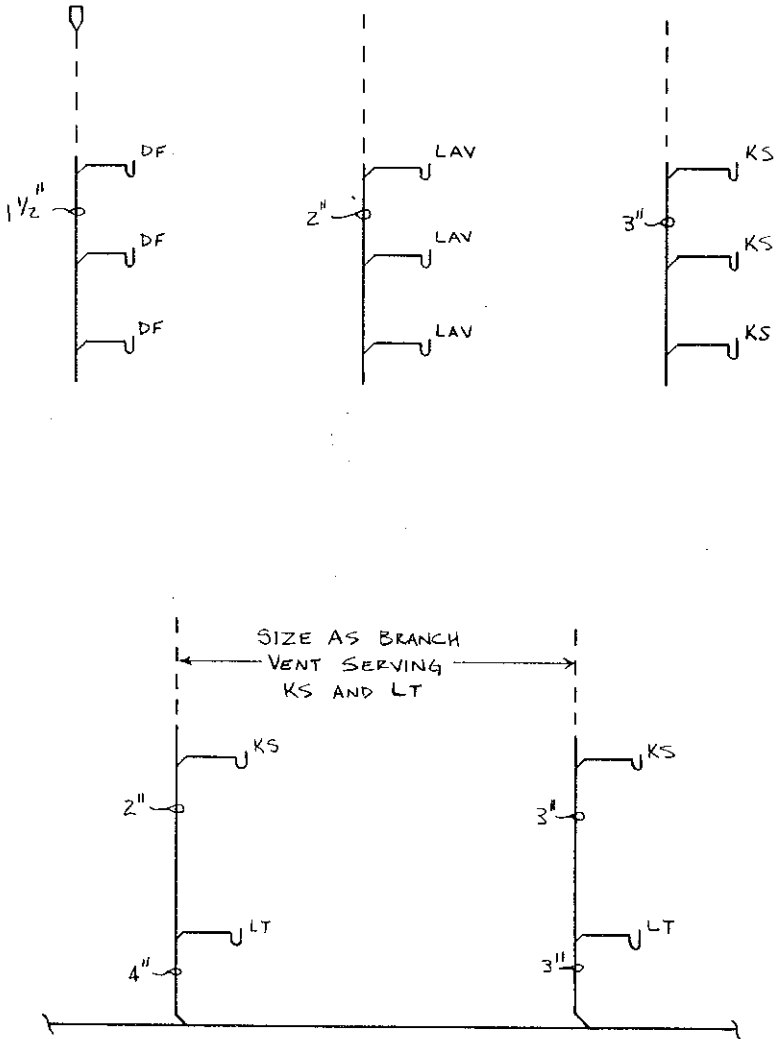

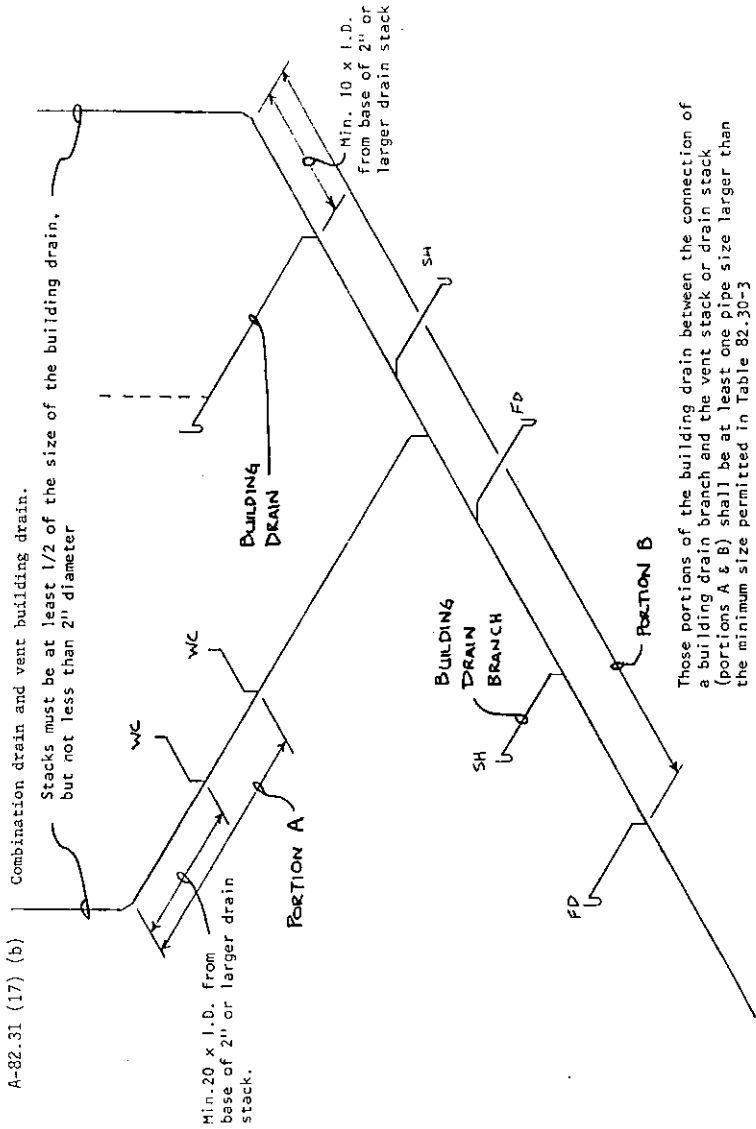

A-82.31 (17) (c) Combination drain and vent laboratory sink venting.

Stack must be at least 1/2 of the size of the horizontal drain but not less than 2" diameter.

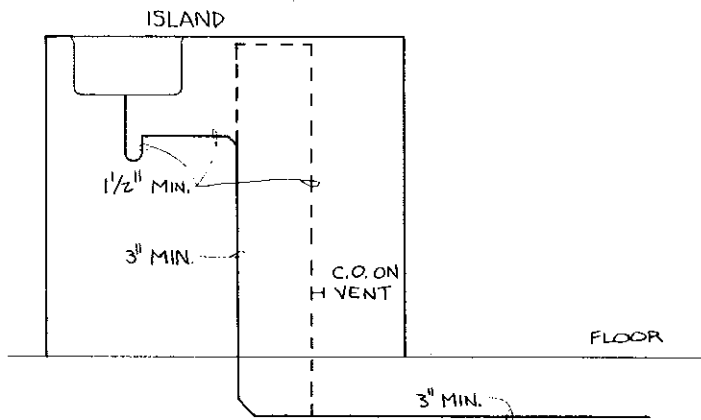
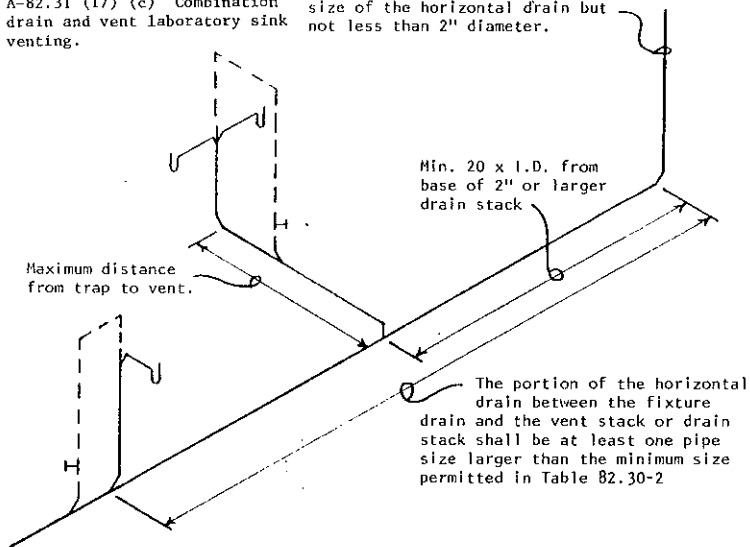

A-82.32 (4) (b) Installation of traps.

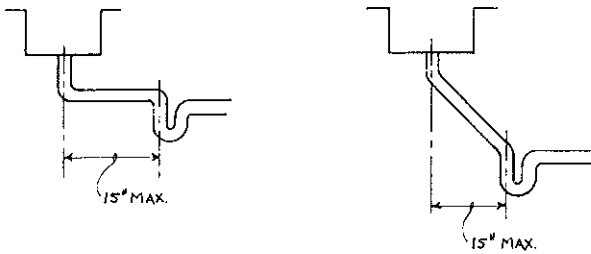
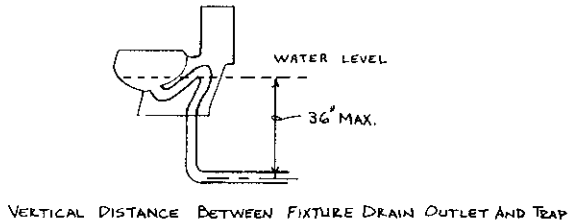
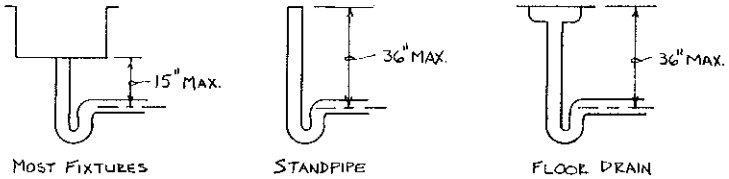

HORIZONTAL DISTANCE BETWEEN FIXTURE DRAIN OUTLET AND TRAP

A-82.33 (6) Indirect and local waste piping.

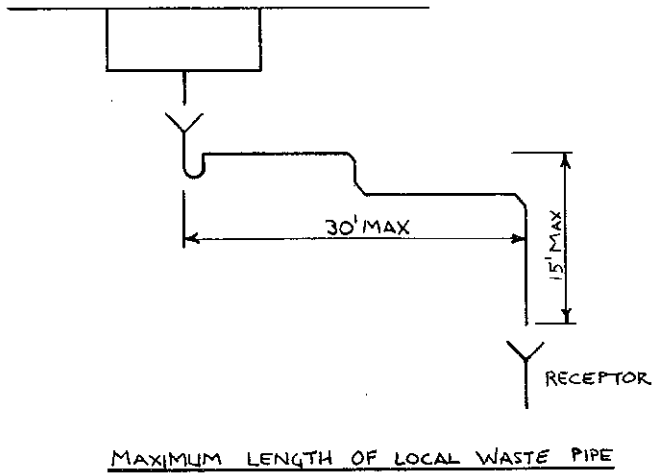
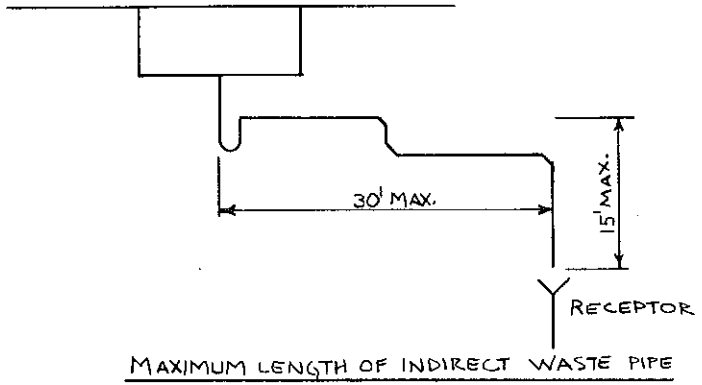



A-82.33 (7) Air-gaps and air-breaks.

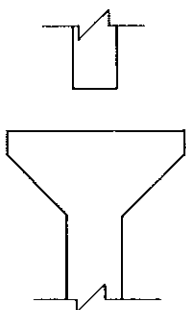

AIR GAP

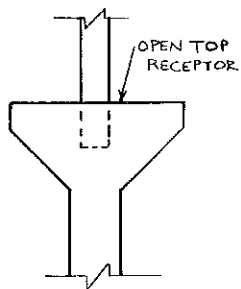

AIR BREAK

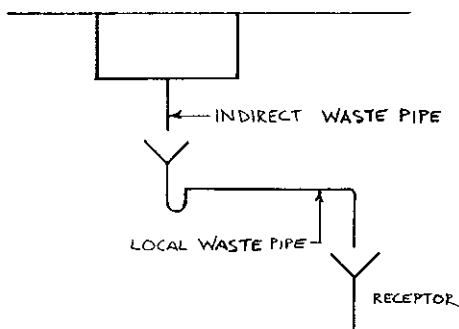

A-82.33 (8) (a) Waste sinks and standpipes.

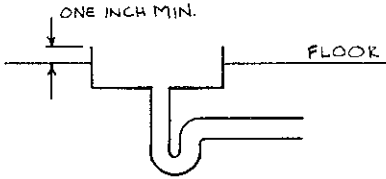

WASTE SINK IN FLOOR

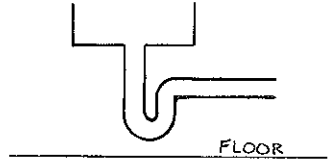

WASTE SINK ABOVE FLOOR

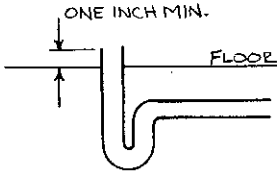

STANDPIPE IN FLOOR

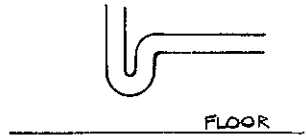

STANDPIPE ABOVE FLOOR

A-82.33 (8) (b) Floor sinks.

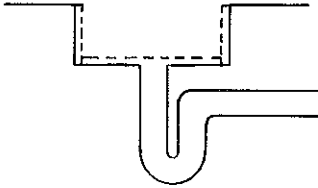

FLOOR SINK WITH BASKET

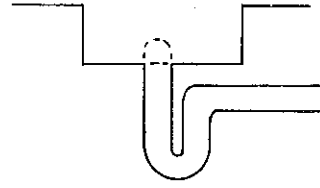

FLOOR SINK WITH DOME STRAINER

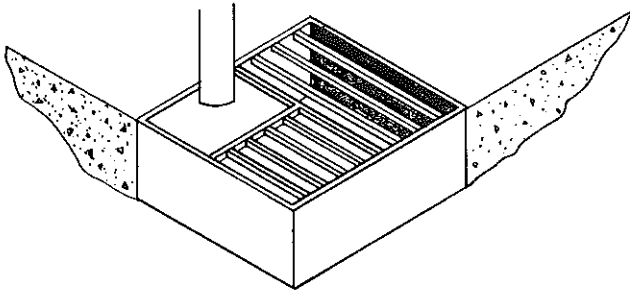

FLOOR SINK WITH GRATE OPENING  
FOR AIR GAP

A-82.33 (8) (c) Local waste piping.

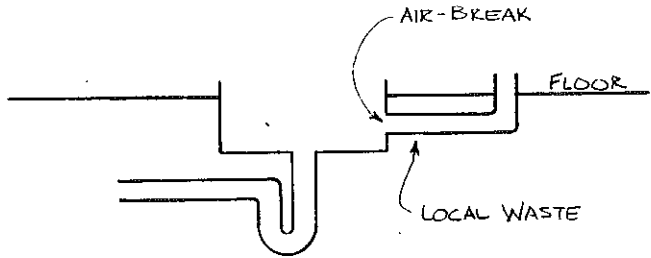

LOCAL WASTE LEADING TO A WASTE SINK,  
FLOOR SINK OR FLOOR DRAIN

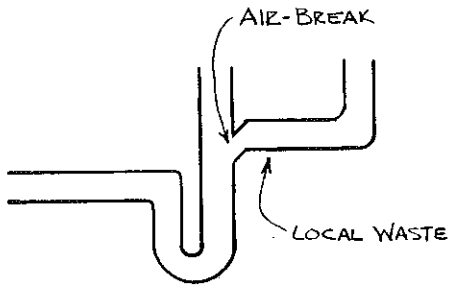

LOCAL WASTE LEADING TO A STANDPIPE

A-82.33 (8) (c) Local waste piping serving water heater relief valves.

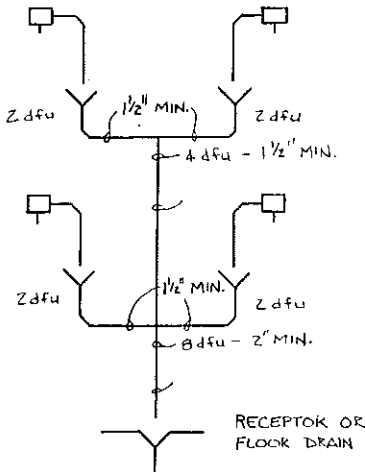
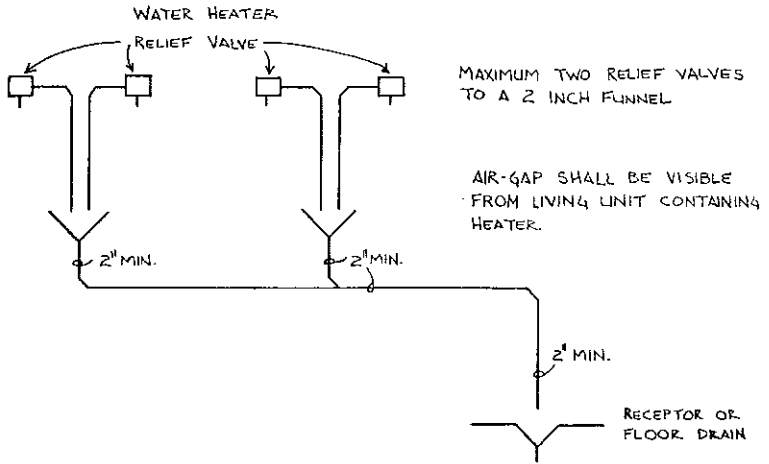

LOCAL WASTE PIPES SERVING WATER HEATER RELIEF VALVES.

A-82.33 (9) (c) Commercial gravity discharge-type clothes washers.

TRENCH TYPE LAUNDRY RECEPTOR

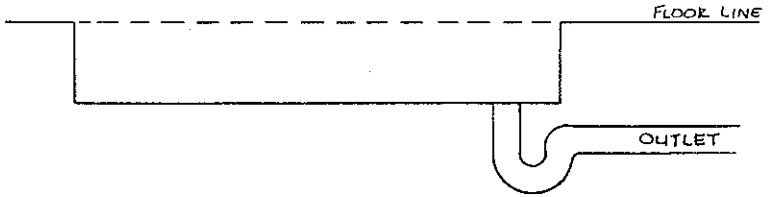

A-82.33 (9) (d) Residential-type dishwashers.

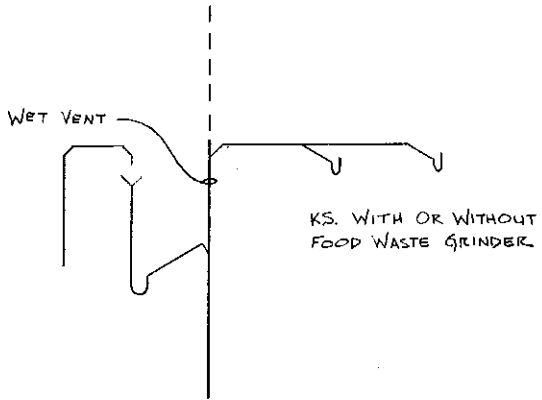
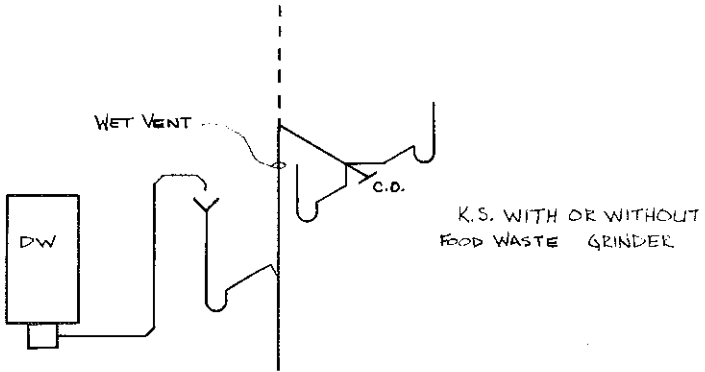

DISHWASHER DISCHARGING TO A STANDPIPE  
BELOW THE COUNTER TOP

A-82.33 (9) (d) Residential-type dishwashers.

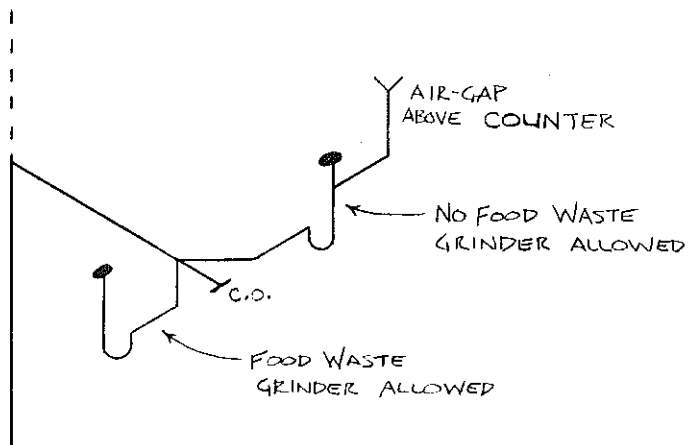
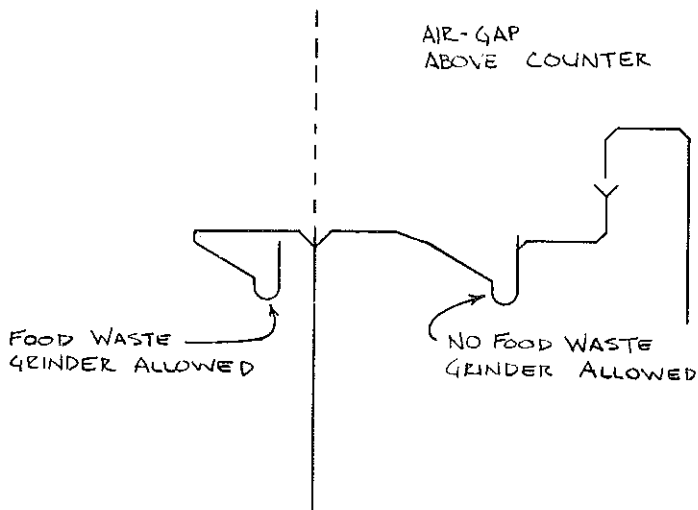



A-82.33 (9) (d) Residential-type dishwashers.

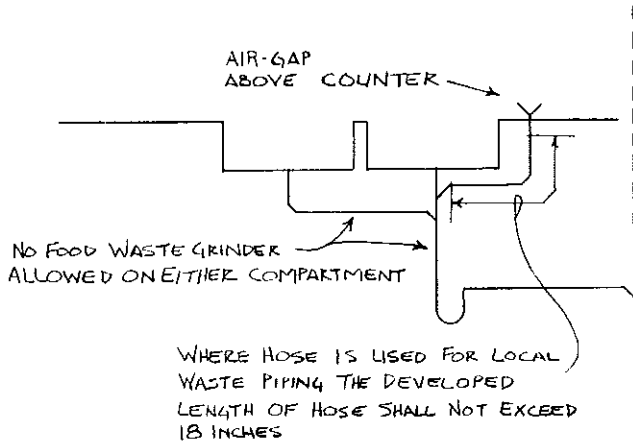
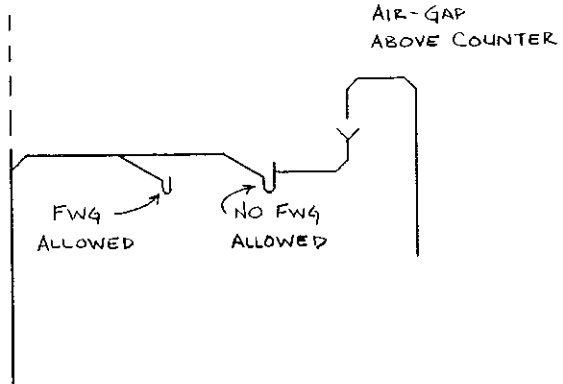

A-82.33 (9) (d) Commercial dishwashers.

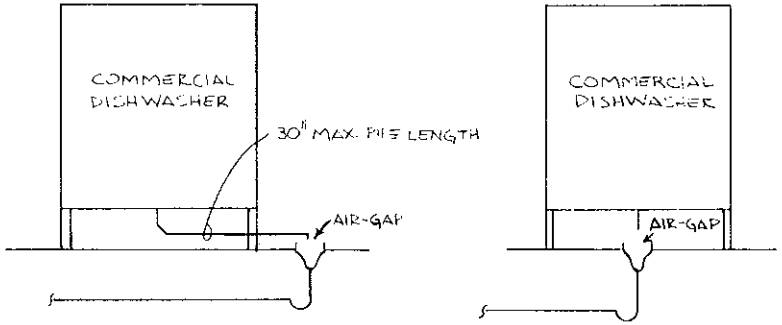

A-82.33 (9) (f) Elevator pit subsoil and floor drains.

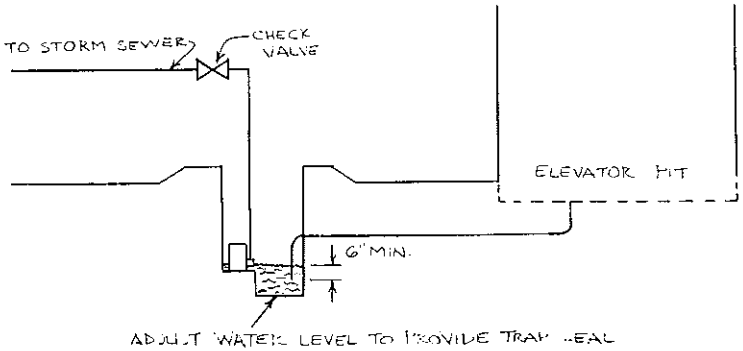

A-82.33 (9) (R) 1. Bar and soda fountain sinks.

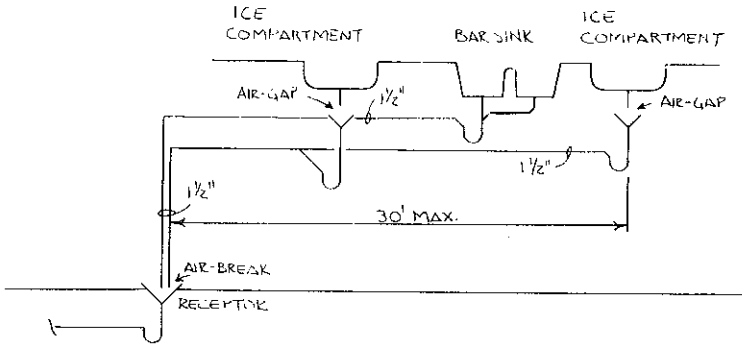

A-82.33 (9) (B) 2.

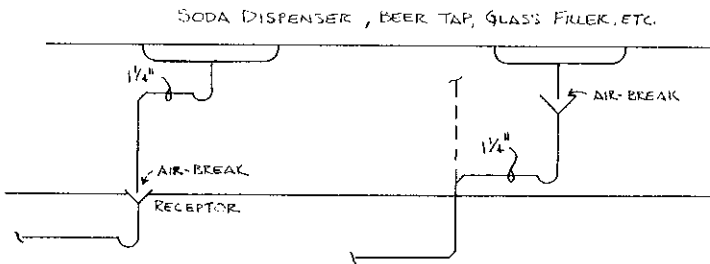

A-82.33 (9) (g) 3. Novelty boxes, ice compartments and ice cream dipper wells.

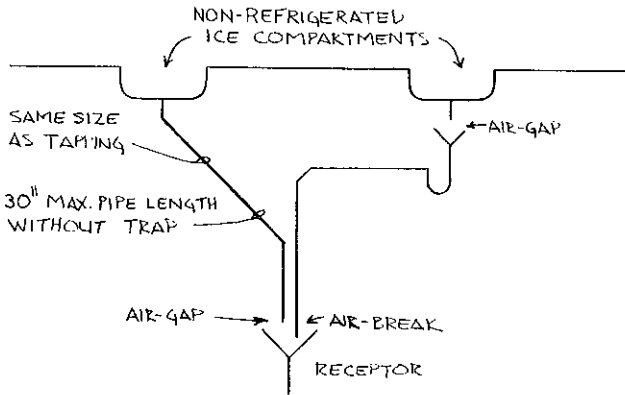
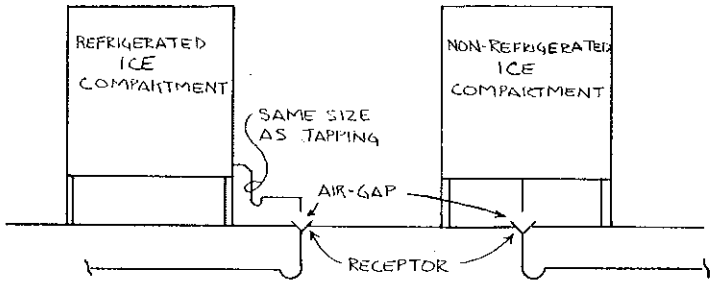

A-82.33 (9) (g) 4. Refrigerated food storage rooms, compartments, and display cases.

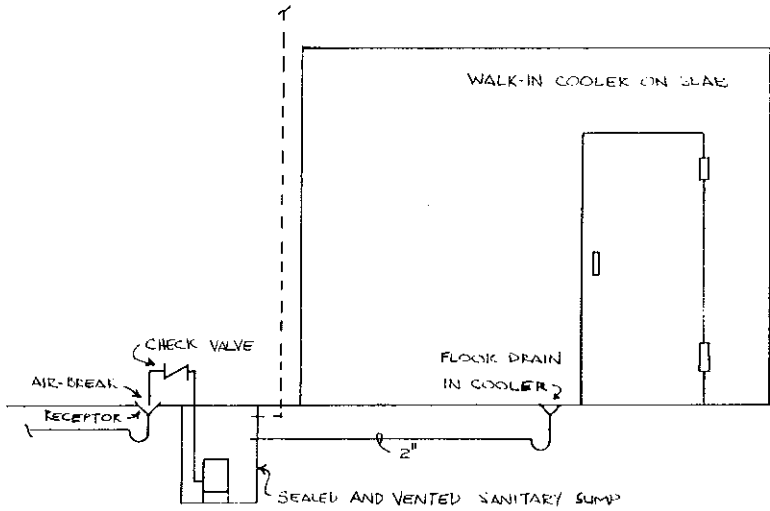
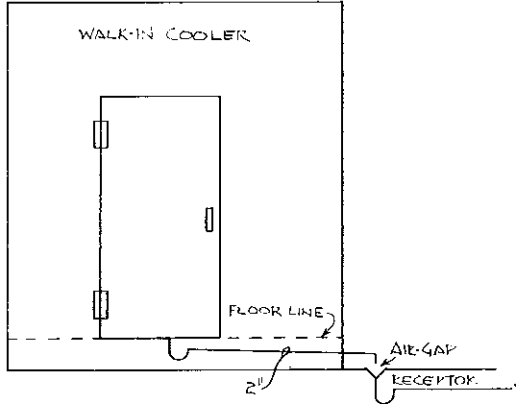

A-82.33 (9) (g) 5. Miscellaneous food handling equipment.

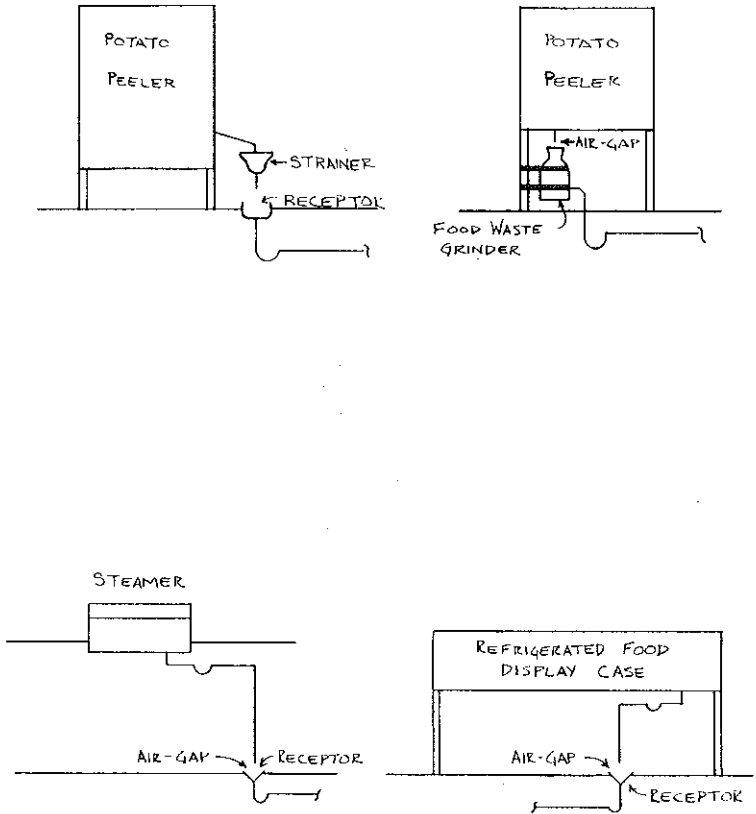

A-82.33 (9) (g) 5. Miscellaneous food handling equipment.

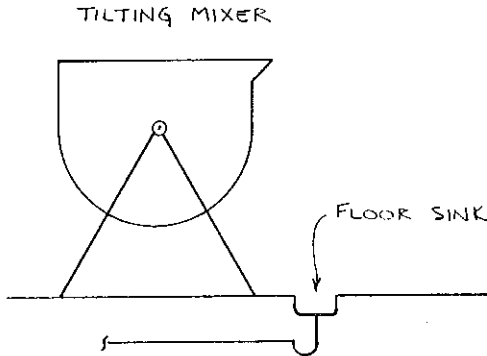
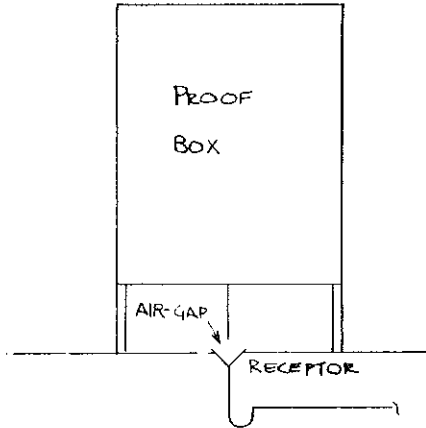

A-82.33 (9) (g) 5. Miscellaneous food handling equipment.

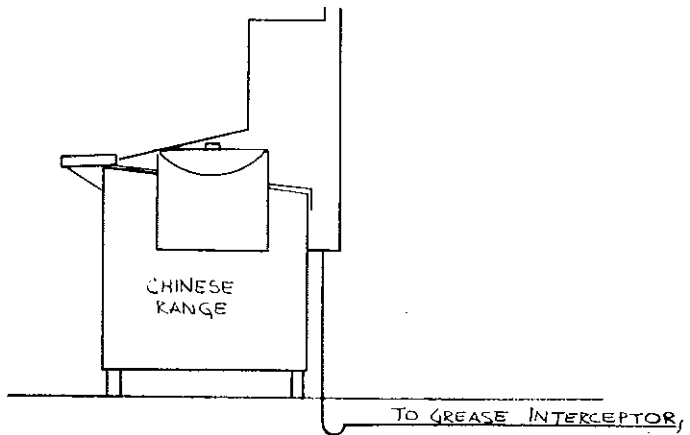
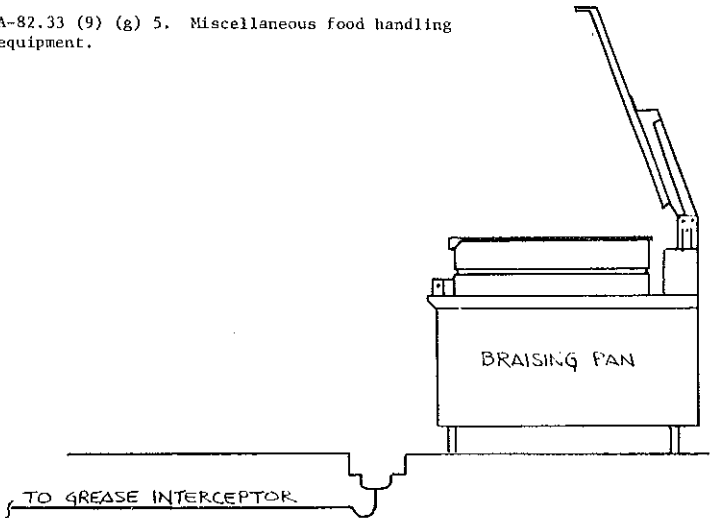



A-82.33 (9) (g) 5. Miscellaneous food handling equipment.

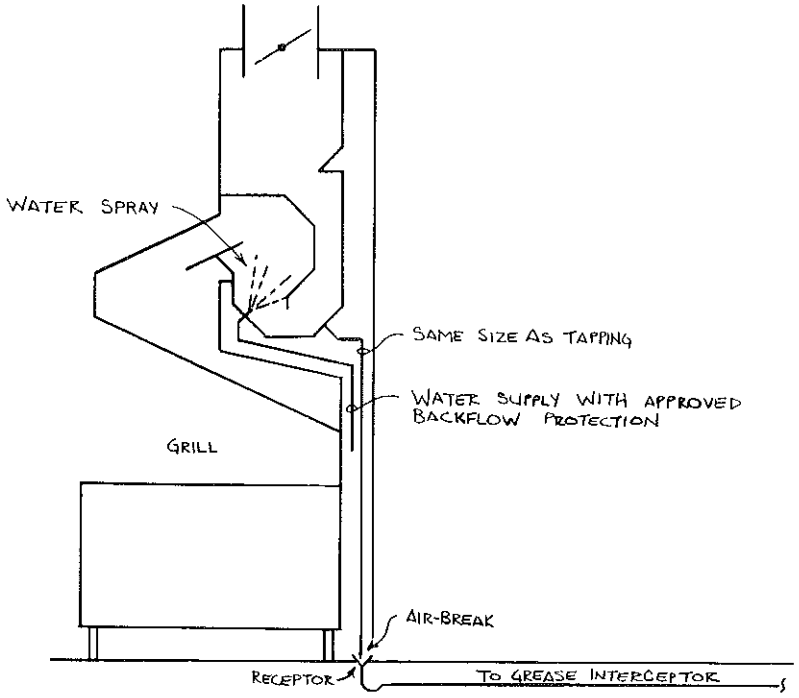

EXHAUST HOOD WASHER

A-82.34 (4) (a)

GARAGE CATCH BASIN

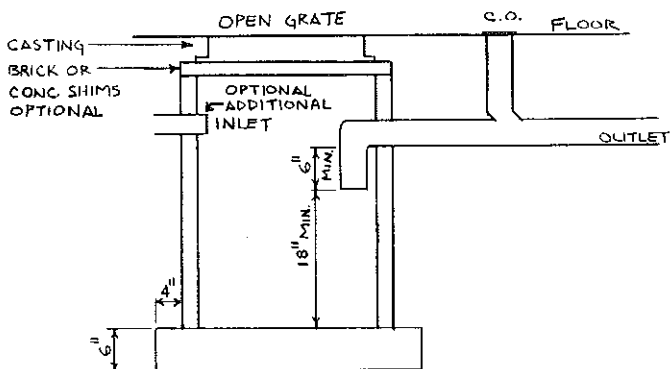

DISCHARGE INTO CATCH BASINS

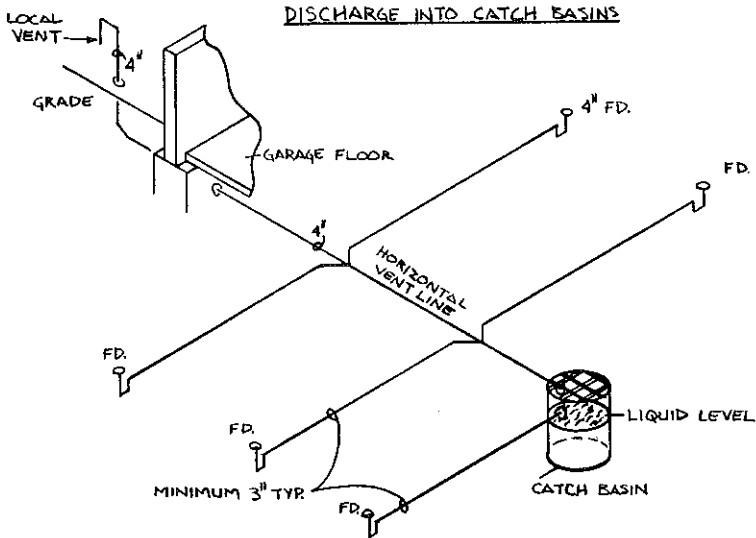

A-82.34 (4) (a)

Capacity of Catch Basins  
(in cubic feet)

Diameter of Catch Basin	Volume in cubic feet per foot of depth	Diameter of Catch Basin	Volume in cubic feet per foot of depth
36	7.1	45	11.1
37	7.5	46	11.6
38	7.9	47	12.1
39	8.3	48	12.6
40	8.7	54	15.9
41	9.2	60	19.7
42	9.7	66	23.8
43	10.1	72	28.3
44	10.6	84	38.6

A-82.34 (4) (a)

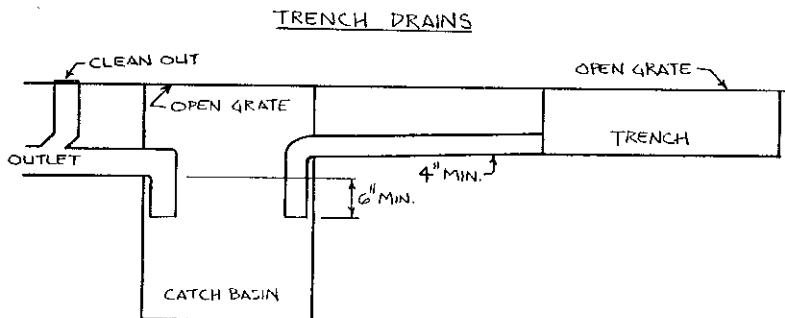

A-82.34 (4) (b)

TYPICAL FLOOR DRAIN WITH SOLID BOTTOM SEDIMENT BASKET

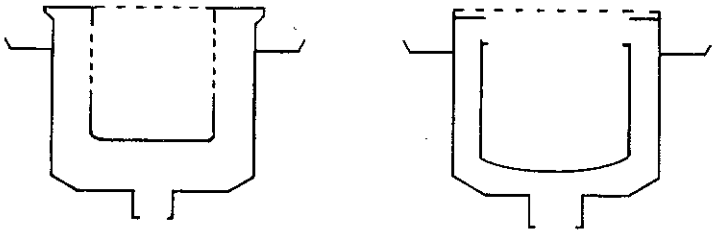

A-82.34 (5) (b)

GREASE INTERCEPTOR MANHOLE LOCATION

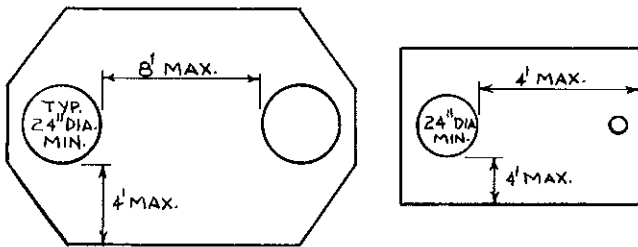

A-82.34 (5) (b)

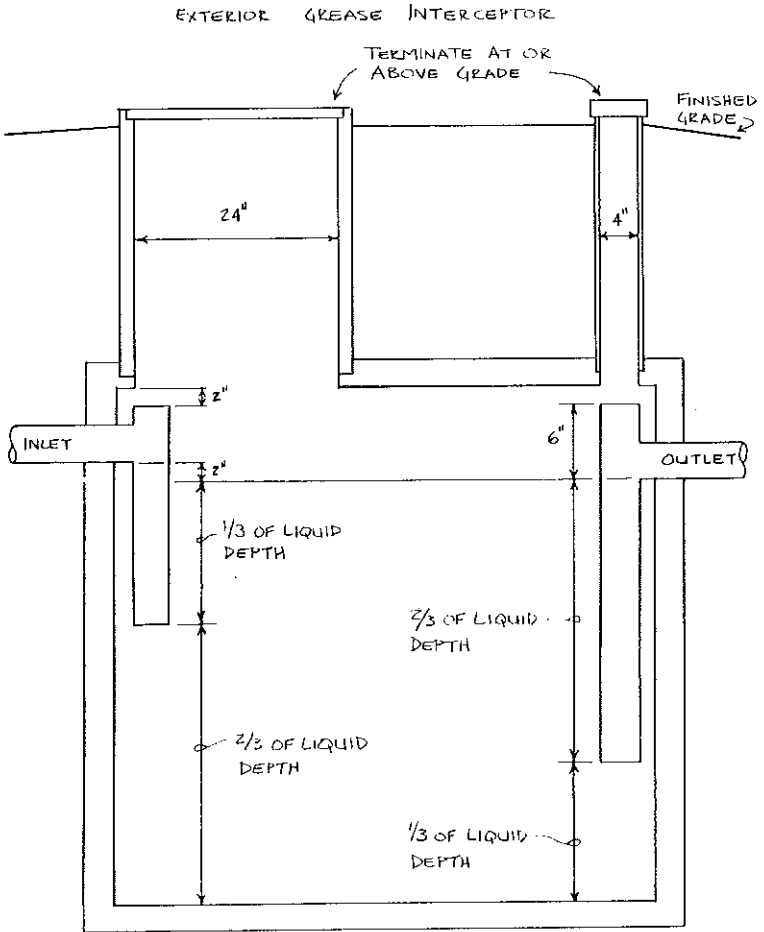

A-82.34 (5) (c) Interior grease interceptors.

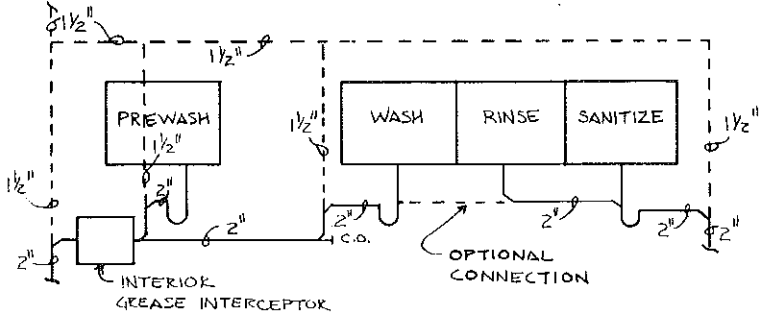

PREWASH AND 3 COMPARTMENT SCULLERY SINK

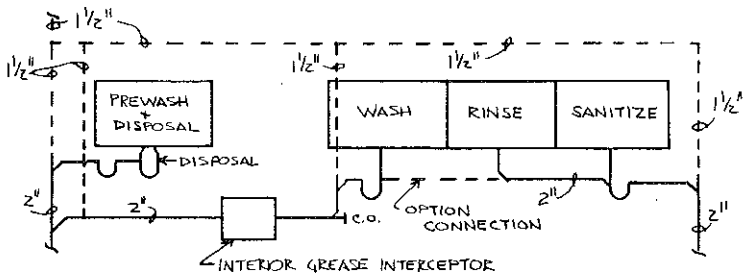

PREWASH + DISPOSAL + 3 COMPARTMENT SCULLERY SINK

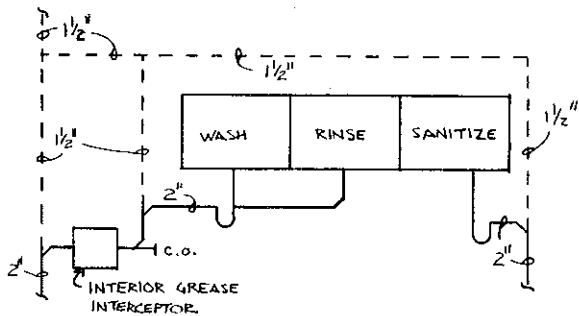

3 COMPARTMENT SCULLERY SINK

A-82.34 (6) Automatic car washes.

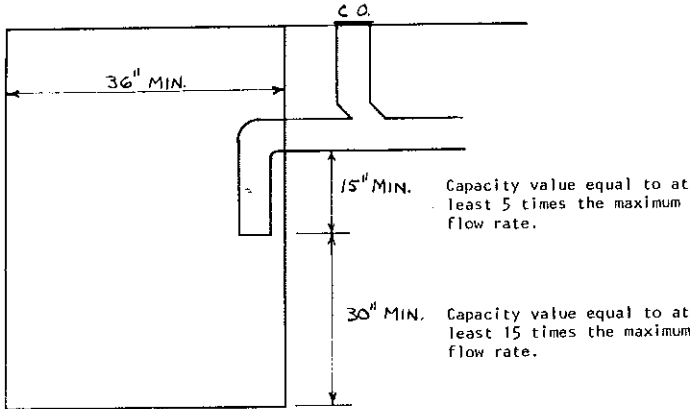

CAR WASH INTERCEPTOR WITH CAST IRON INVERT INSIDE OF BASIN

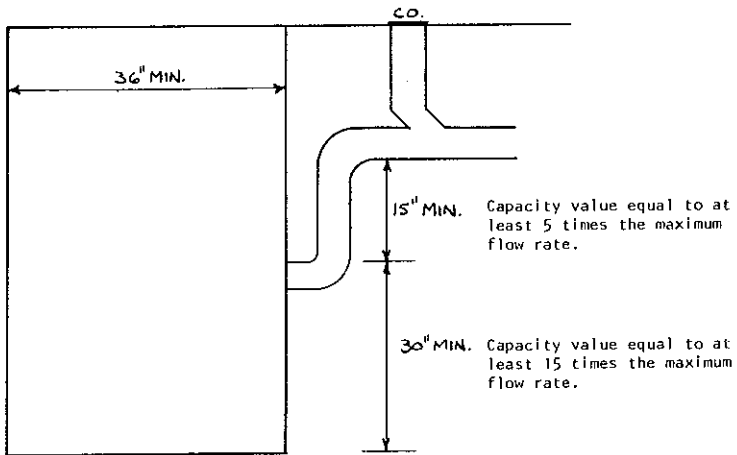

CAR WASH INTERCEPTOR WITH INVERT OUTSIDE OF BASIN

A-82.34 (7) Commercial laundries.

TRENCH TYPE LAUNDRY INTERCEPTOR

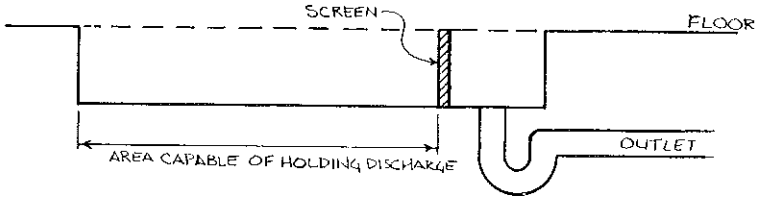

IN-LINE LAUNDRY INTERCEPTOR

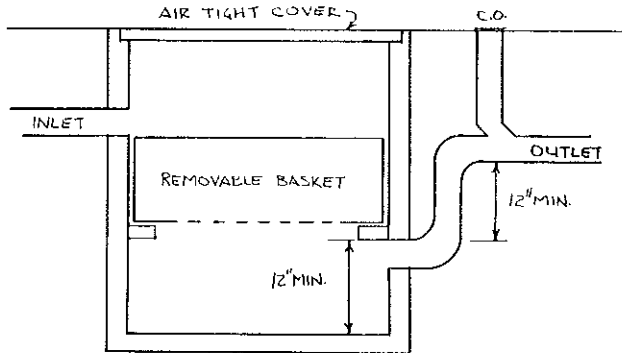



A-82.34 (8)

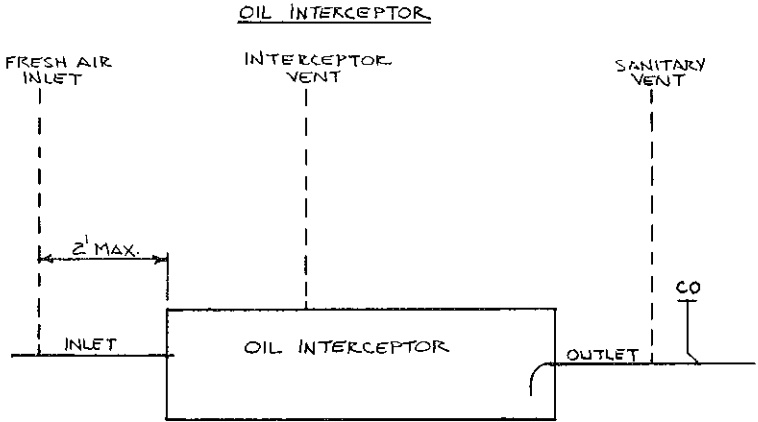

A-82.34 (13)

PLASTER AND HEAVY SOLIDS TRAP

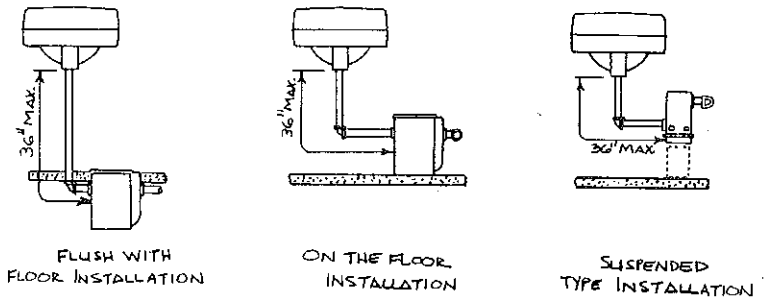

A-82.34 (14) Chemical dilution and neutralizing basins.

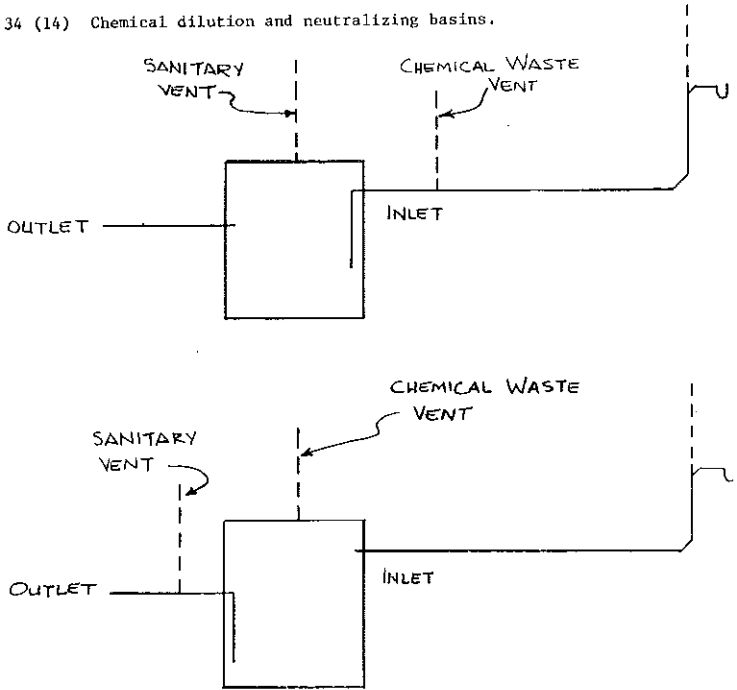

A-82.35 (3)

CLEANOUTS SERVING HORIZONTAL  
DRAINS WITHIN OR UNDER A BUILDING

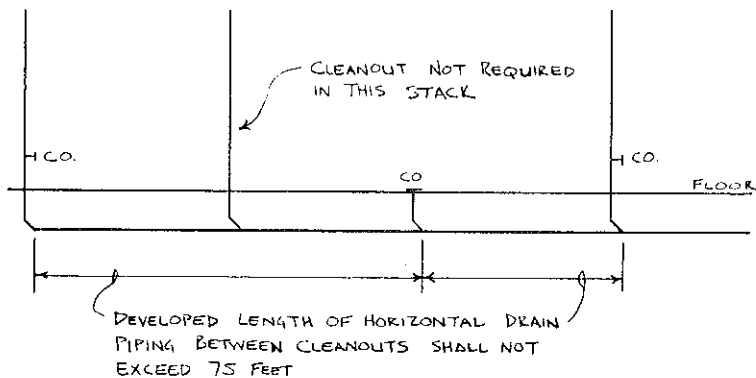

A-82.35 (3) Cleanouts serving horizontal drains.

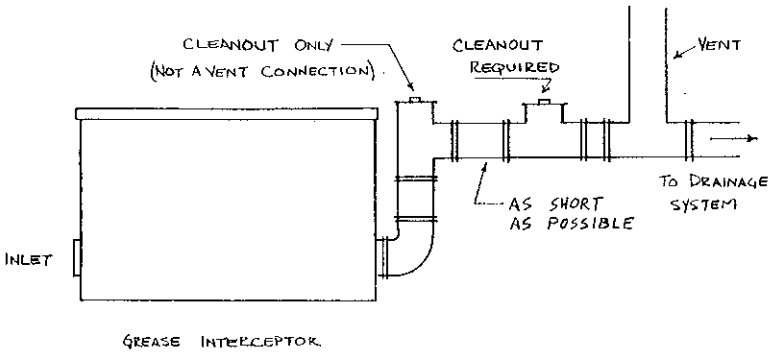
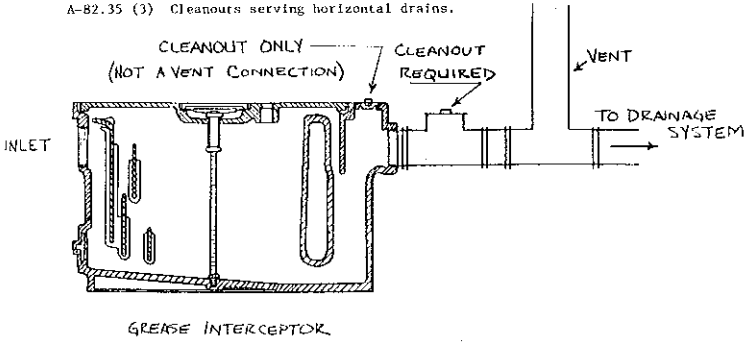

A-82.34 (5) (a) Cleanout extension to grade.

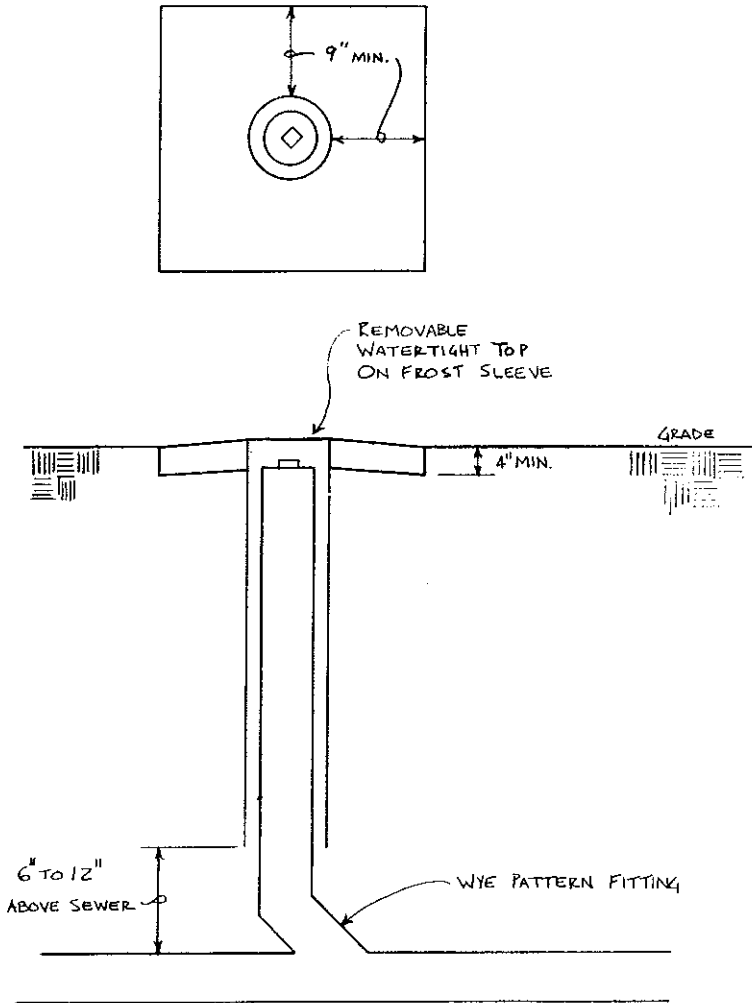

A-82.35 (8)

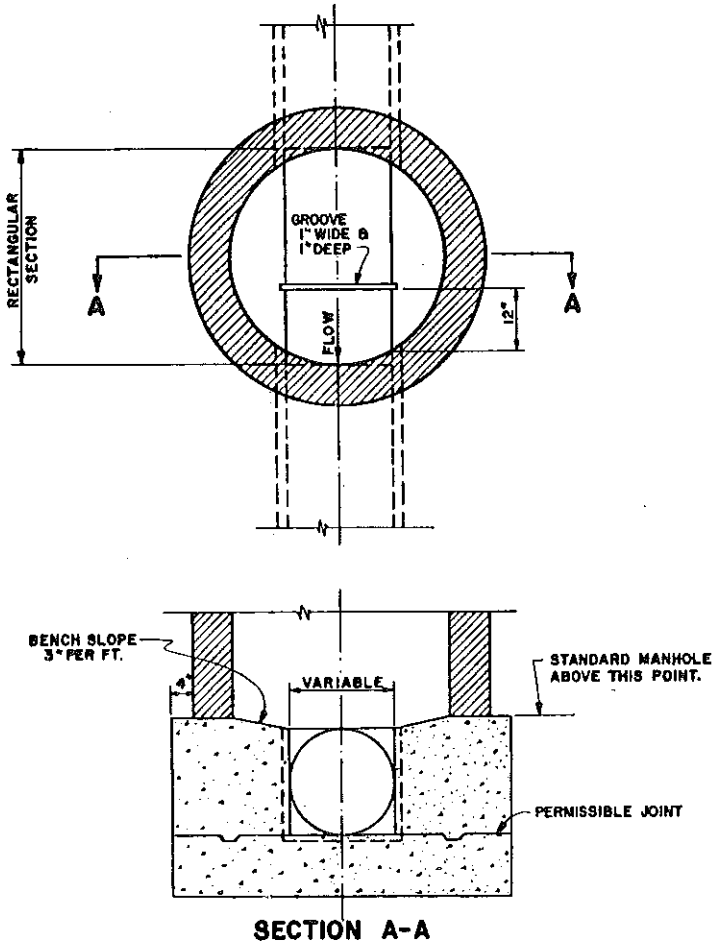

**SECTION A-A**  
**DETAIL OF SAMPLING MANHOLE**

A-82.36 (17) Area drain inlets.

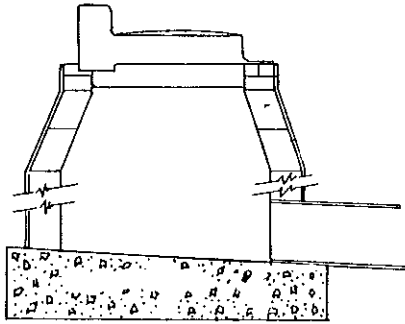

**STANDARD STORM WATER  
INLET (MASONRY)**

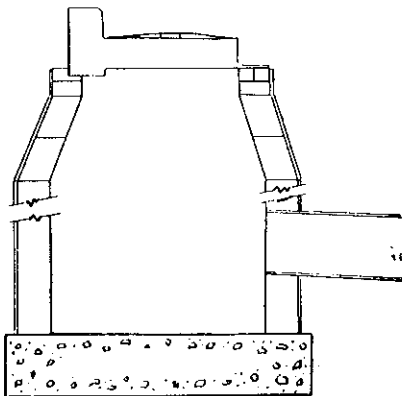

**STANDARD STORM WATER  
CATCH BASIN (MASONRY)**

A-82.36 (17) Area  
drain inlets.

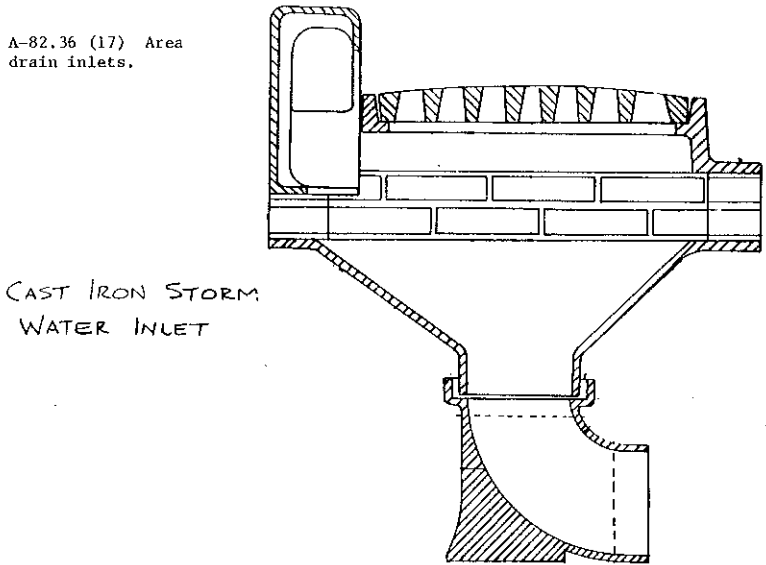

CAST IRON STORM  
WATER INLET

A-82.51 (3) Mobile home sites and parks.

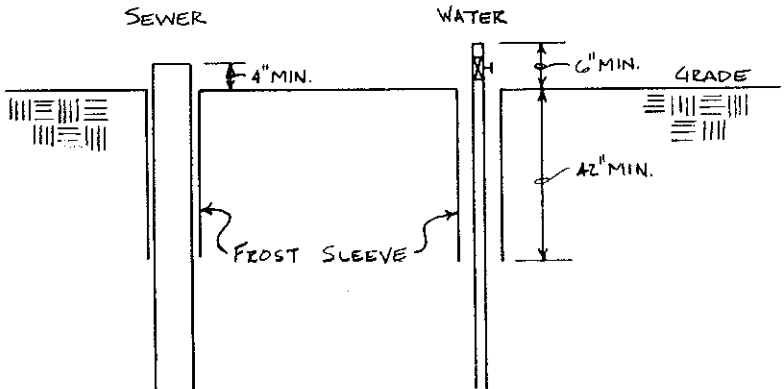

MOBILE HOME BUILDING SEWER AND  
WATER SERVICE TERMINATIONS



## INDEX

See also first page of the chapter for the listing of section headings.

## A

	<i>ILHR Section No(s).</i>
ACCESS	
To backwater valves .....	82.30 (11) (a) 2. b.
To cleanouts .....	82.35 (5)
To fixture traps .....	82.32 (4) (a), 82.35 (3) (j)
To floor drains .....	82.32 (5)
To interceptors .....	82.34 (3) (f)
ADMINISTRATION AND ENFORCEMENT .....	82.20, 82.21
Petition for variance .....	82.20 (12)
Plan review and approval .....	82.20 (1) (a), 82.20 (1) (b)
Priority plan review .....	82.20 (3)
AGENT MUNICIPALITIES .....	82.20 (2)
AIR BREAK	
Definition .....	82.11 (3)
Installation .....	82.33 (7) (b)
Required .....	82.33 (9)
AIR GAP	
Definition .....	82.11 (4), 82.11 (5)
Installation .....	82.33 (7) (a)
Required .....	82.33 (9)
AIR INTAKE	
Distance to vent terminal .....	82.31 (16) (d)
AIR TEST .....	82.21 (1) (d)
AREA DRAINS .....	82.36 (17)
AREAWIDE WATER QUALITY MANAGEMENT PLAN	
Definition .....	82.11 (11)
Conformance .....	82.20 (4) (c)
ASPIRATOR .....	82.41 (1) (h)
ATMOSPHERIC VACUUM BREAKER .....	82.41 (1) (l), 82.41 (1) (p)
AUTOPSY TABLE .....	82.41 (1) (h)

## B

BACKFILLING .....	82.30 (11) (d)
BACKFLOW PREVENTER	
Definition .....	82.11 (17)
Required .....	82.41
BACKFLOW PROTECTION .....	82.41
BACKWATER VALVES	
Accessibility .....	82.30 (11) (a) 2. b.
Definition .....	82.11 (19)
Where required .....	82.30 (11) (a) 2.
BAROMETRIC LOOP .....	82.41 (1) (p)
BEDDING FOR SEWERS .....	82.30 (11) (d) 2.
BOTTLING ESTABLISHMENTS .....	82.34 (9)
BRANCH INTERVAL	
Definition .....	82.11 (29)
Loading limits .....	82.30 (4) (a)

<b>BUILDING DRAIN</b>	
Definition.....	82.11 (34)
Installation.....	82.30 (11)
Sizing, sanitary .....	82.30 (4) (a), 82.30 (4) (b)
Sizing, storm.....	82.36 (5)
<b>BUILDING SEWERS</b>	
Connections to main .....	82.30 (11) (e)
Definition.....	82.11 (38), 82.11 (39), 82.11 (40)
Frost protection.....	82.30 (11) (b) 2.
Installation .....	82.30 (11) (d)
Sizing, sanitary .....	82.30 (4) (a), 82.30 (4) (c)
Sizing, storm.....	82.36 (5) (e)
 <b>C</b> 	
CAR WASH, AUTOMATIC.....	82.34 (6)
CHANGES IN DIRECTION, DRAIN PIPING .....	82.30 (8)
CATCH BASINS, GARAGE.....	82.34 (4)
CHEMICAL WASTE PIPING SYSTEMS.....	82.34 (14)
<b>CIRCUIT VENTS</b>	
Definition.....	82.11 (45)
Installation .....	82.31 (10)
Sizing.....	82.31 (14) (f)
<b>CLEANOUTS</b>	
Accessibility.....	82.35 (5)
Required.....	82.35 (3)
Size .....	82.35 (6)
<b>CLEAR WATER DRAINS</b>	
Indirect waste piping .....	82.33 (9) (b)
Segregation of wastes.....	82.36 (3) (c)
Sizing.....	82.36 (5) (c)
CLOTHES WASHERS.....	82.33 (9) (c)
<b>COMMON VENTS</b>	
Definition.....	82.11 (50)
Installation .....	82.31 (11)
Sizing.....	82.31 (14) (e)
<b>CONDUCTORS</b>	
Definition.....	82.11 (51)
Sizing.....	82.36 (5) (b)
<b>CONTINUOUS FLOW DEVICES</b>	
Sanitary system .....	82.30 (3) (b)
Storm system.....	82.36 (4) (b)
CONTROLLED FLOW ROOF DRAIN SYSTEMS.....	82.36 (19)
<b>CORPORATION COCK</b>	
Definition.....	82.11 (53)
Required.....	82.40 (2) (c)
<b>CROSS CONNECTIONS</b>	
Definition.....	82.11 (55)
Control.....	82.41
<b>CURB STOP</b>	
Definition.....	82.11 (56)
Required.....	82.41 (2) (c)

## D

DEAD ENDS.....	82.21 (2) (i)
DEFINITIONS.....	82.11
DETRIMENTAL WASTES.....	82.34 (3)
DEVELOPED LENGTH	
Definition.....	82.11 (59)
Between vent and trap.....	82.31 (9)
DISHWASHING MACHINES.....	82.33 (9) (d)
DISINFECTION OF POTABLE WATER SYSTEMS.....	82.40 (6)
DRAINAGE FIXTURE UNITS — (SEE FIXTURE UNITS, DRAINAGE)	

## E

EJECTORS	
Definition.....	82.11 (64)
Requirements.....	82.30 (10) (b)
ELEVATOR PIT SUBSOIL AND FLOOR DRAINS.....	82.33 (9) (f)
ENERGY CUTOFF DEVICES.....	82.40 (4) (h)

## F

FITTINGS	
Minimum radius in drain system.....	82.30 (8)
Prohibited.....	82.30 (9) (c)
FIXTURE DRAIN CONNECTIONS	
Direct.....	82.32 (4), 82.32 (5)
Indirect.....	82.33
FIXTURE UNITS, DRAINAGE	
Definition.....	82.11 (69)
Values for continuous flow.....	82.30 (3) (b)
Values for intermittent flow.....	82.30 (3) (a)
FIXTURE UNITS, SUPPLY	
Definition.....	82.11 (70)
Assigned to various fixtures.....	82.40 (4)
FLOOD LEVEL RIM	
Definition.....	82.11 (72)
FLOOR DRAINS	
Required.....	82.30 (11) (a) 3.
FLOOR SINKS	
Definition.....	82.11 (73)
Requirements.....	82.33 (8) (b)
FOOD HANDLING ESTABLISHMENTS.....	82.33 (9) (g)
FREEZING, PROTECTION OF PIPES.....	82.40 (4) (d)
FROST PROTECTION, SEWERS.....	82.30 (11) (b) 2.
FUTURE FIXTURES.....	82.30 (4) (e)

## G

GARAGE CATCH BASINS.....	82.34 (4)
GARBAGE CAN WASHERS.....	82.32 (5) (a)
GREASE INTERCEPTORS.....	82.34 (5)

H

HANGERS AND SUPPORTS .....	82.60
HEALTH CARE AND RELATED FACILITIES .....	82.50
HOT WATER	
Heaters and tanks .....	82.40 (4) (g)
Recirculation .....	82.40 (4) (c)
Required .....	82.40 (4) (c)

I

INDIRECT WASTE PIPING .....	82.33
Boilers, pressure tanks and relief valves .....	82.33 (9) (a)
Clear water wastes .....	82.33 (9) (b)
Clothes washers .....	82.33 (9) (c)
Dishwashing machines .....	82.33 (9) (d)
Drips and drain outlets .....	82.33 (9) (e)
Elevator pit subsoil and floor drains .....	82.33 (9) (f)
Food handling establishments .....	82.33 (9) (g)
Receptors .....	82.33 (8)
Sterilizers .....	82.33 (9) (h)
Swimming pools .....	82.33 (9) (i)
Vacuum systems - central units .....	82.33 (9) (j)
INDIVIDUAL VENTS .....	82.31 (9)
INSPECTIONS .....	82.21 (1)
INSULATION, SEWERS .....	82.30 (11) (b)
INTERCEPTORS .....	82.34
Accessibility .....	82.34 (3) (f)
Automatic car washes .....	82.34 (6)
Bottling establishments .....	82.34 (9)
Chemical dilution and neutralizing basins .....	82.34 (14)
Commercial laundries .....	82.34 (7)
Dairy product processing plants .....	82.34 (10)
Garage catch basins .....	82.34 (4)
Grease interceptors .....	82.34 (5)
Meat processing plants and slaughterhouses .....	82.34 (11)
Oil and flammable liquids .....	82.34 (8)
Plaster and heavy solids .....	82.34 (13)
Sand .....	82.34 (12)
INTERCONNECTIONS .....	82.41

J

K

KITCHEN SINK DRAIN CONNECTIONS .....	82.32 (5) (b)
--------------------------------------	---------------

L

LAUNDRIES	
Commercial .....	82.33 (9) (c), 82.34 (7)
Self-service .....	82.33 (9) (c)
LOCAL VENT, INTERCEPTORS .....	82.34 (4) (a) 2.
LOCAL WASTES .....	82.33

## M

MAIN STACK.....	82.31 (3) (b)
MAINTENANCE .....	82.21 (2)
MANHOLES.....	82.35

## N

NONPOTABLE WATER .....	82.11 (102)
NOTIFICATION FOR INSPECTION .....	82.21 (1)

## O

## OFFSETS

Definition.....	82.11 (106)
In drains .....	82.30 (6)
In vents .....	82.31 (15) (b)
OIL INTERCEPTORS .....	82.34 (8)

## P

## PIPING PROTECTION

Backfilling.....	82.30 (11) (d)
Frost protection .....	82.30 (11) (b)
Trenching and bedding .....	82.30 (11) (d)
Wheel loading .....	82.30 (11) (d) 4.

## PITCH

Drain piping .....	82.30 (5)
Vent piping .....	82.31 (15), 82.31 (12) (c)

## PLAN REVIEW AND APPROVAL .....

## PRIVATE INTECEPTOR MAIN SEWERS

Definition.....	82.11 (118)
Installation .....	82.30 (12)
Sizing .....	82.30 (4) (d)
Conformance to areawide water quality management plan .....	82.20 (4) (c) 2.

## PUMPS

Sewage.....	32.30 (10)
Storm and clear water.....	32.36 (11)

## Q

## R

## RADII OF DRAIN FITTINGS..... 82.30 (8)

## REDUCED PRESSURE PRINCIPLE-TYPE

## BACK-FLOW PREVENTER

Definition.....	82.11 (126)
Annual testing .....	82.21 (2) (a)

## RELIEF VENTS

Building drain.....	82.31 (7)
Circuit vented horizontal drain.....	82.31 (10) (b)
Drain stack offset.....	82.30 (6) (b), 82.31 (5)

Sizing.....	82.31 (14) (g)
Wet vented horizontal drain .....	82.31 (13) (b)
ROOF DRAINS .....	82.36 (18), 82.36 (19)

S

SAND INTERCEPTOR .....	82.34 (12)
SANITARY DRAIN SYSTEM .....	82.30
SLAUGHTERHOUSES.....	82.34 (11)
SMOKE TEST .....	82.21 (1) (d)
STORM AND CLEAR WATER DRAIN SYSTEMS .....	82.36
SUMPS	
Sanitary .....	82.30 (10)
Storm.....	82.36 (11)
SWIMMING POOLS .....	82.33 (9) (i)

T

TEMPERATURE OF WASTE .....	82.33 (9) (a)
TESTING AND MAINTNANCE .....	82.21 (2)
TRAPS .....	82.32
Required.....	82.32 (3)
Prohibited types .....	82.32 (3) (f)
TRENCHING, EXCAVATION, BACKFILL .....	82.30 (11) (d)

U

UNDERGROUND DRAIN PIPING	
Minimum size .....	82.30 (4) (b)
USED PIPING MATERIAL AND FIXTURES .....	82.21 (2) (e)

V

VACUUM BREAKERS .....	82.40
VALVES	
Backwater .....	82.30 (11) (a) 2.
Pressure reducing .....	82.40 (4) (c) 2.
Relief .....	82.40 (4) (h)
Safety .....	82.40 (4) (g) 2.
Control, water .....	82.40 (2) (c), 82.40 (4) (j)
VELOCITY	
Drain lines .....	82.30 (5)
Water lines .....	82.40 (4)
VENT STACK	
Definition.....	82.11 (169)
Required.....	82.31 (4)
VENTS AND VENTING SYSTEMS .....	82.31
Circuit .....	82.31 (10)
Combination drain and vent .....	82.31 (17)
Common .....	82.31 (17)
Developed length between vent and trap .....	82.31 (9)
Individual.....	82.31 (9)

ILHR 82

Island fixtures .....	82.31 (12)
Laboratory sink .....	82.31 (17) (c)
Main stack required .....	82.31 (3) (b)
Relief .....	82.30 (6) (b), 82.31 (5), 82.31 (7), 82.31 (10) (b)
Sizing .....	82.31 (14)
Stack vents required .....	82.31 (13)
Vent grades and connections .....	82.31 (15)
Vent stack required .....	82.31 (4)
Vent terminals .....	82.31 (16)
Wet vent .....	82.31 (13)
Yoke .....	82.30 (6) (b), 82.31 (5), 82.31 (6)

## W

WASTE WATER TEMPERATURE .....	82.33 (9) (a)
WATER SUPPLY SYSTEMS .....	82.40
Control valves .....	82.40 (4) (j)
Distribution .....	82.40 (4)
Relief valves .....	82.40 (4) (h)
Service .....	82.40 (2)
Sizing .....	82.40 (2), 82.40 (4)
WATER TEST .....	82.21 (1) (d)
WET VENTING .....	82.31 (13)

## Y

## YOKE VENTS

Definition .....	82.11 (186)
Required .....	82.30 (6) (b), 82.31 (5), 82.31 (6)
Size .....	82.31 (14) (h)

Chapter ILHR 83

PRIVATE SEWAGE SYSTEMS

ILHR 83.01	Purpose (p. 259)	ILHR 83.13	Installation—conventional soil absorption systems (p. 286)
ILHR 83.02	Definitions (p. 260)	ILHR 83.14	Pressure distribution systems (p. 288)
ILHR 83.03	Approvals and limitations (p. 266)	ILHR 83.15	Septic tanks and other treatment tanks (p. 298)
ILHR 83.04	Specific limitations (p. 266)	ILHR 83.16	Maintenance and sludge disposal (p. 303)
ILHR 83.05	Local filing requirements (p. 268)	ILHR 83.17	Chemical restoration (p. 303)
ILHR 83.06	County administration (p. 269)	ILHR 83.18	Holding tanks (p. 303)
ILHR 83.07	Plan review—department (p. 271)	ILHR 83.19	Inspection and tests (p. 306)
ILHR 83.08	Examination of plans and specifications (p. 272)	ILHR 83.20	Materials (p. 306)
ILHR 83.09	Site evaluation (p. 273)	ILHR 83.21	Building sewers and drains (p. 312)
ILHR 83.10	Site requirements (p. 280)	ILHR 83.22	Alternative private sewage systems (p. 312)
ILHR 83.11	Initial adverse determination (p. 283)	ILHR 83.23	Mound systems (p. 315)
ILHR 83.12	Sizing soil absorption systems (p. 284)		Appendix (p. 340)

Note: Chapter H 63 was created as an emergency rule effective 6-21-80; chapter H 63 as it existed on June 30, 1983 was renumbered to chapter ILHR 83.

**ILHR 83.01 Purpose.** (1) **GENERAL.** The underlying principles of this chapter as authorized in s. 145.02 (2), Stats., are basic goals in environmental health and safety accomplished by proper siting, design, installation, inspection, and maintenance of private sewage systems. The prerequisites necessary for the essential protection of the health of the public and the environment are the same everywhere. As unforeseen situations arise which are not specifically covered in this chapter the basic principles enumerated in this section shall serve to define intent.

(2) **BASIC PRINCIPLES.** (a) *Need.* Every building intended for human habitation or occupancy shall be provided with a properly functioning system for treatment and disposal of domestic waste.

(b) *Public sewers.* Every building intended for human habitation or occupancy on land abutting a street, right-of-way, or easement in which there is a public sewer, or on land deemed accessible to public sewer, shall have an individual connection to the public sewer and the private sewage system serving such building shall be properly abandoned.

(c) *Discharges prohibited.* Every private sewage system shall be designed, located and constructed to prevent any discharge of sewage or partially treated sewage into drain tiles, onto the ground surface, into the structure served, into the surface waters of the state or into the groundwater of the state including zones of seasonal soil saturation.

(d) *Maintenance.* Every private sewage system shall be adequately maintained.

(e) *Nuisance.* Every private sewage system shall be designed, located and constructed so as not to create a nuisance.



## ILHR 83

(f) *Sizing*. Every private sewage system shall be designed and constructed to adequately dispose of all the wastewater generated in the structure or facility it is serving.

History: Cr. Register, December, 1980, No. 300, eff. 1-1-81; renum. from II 63.01, Register, June, 1983, No. 330, eff. 7-1-83.

**ILHR 83.02 Definitions.** For the purpose of this chapter, the following definitions shall apply. The dictionary meaning shall apply for all other words.

(1) "Aggregate" means washed graded hard rock that has been washed with water under pressure over a screen during or after grading to remove fine material and with a hardness value of 3 or greater on Moh's Scale of Hardness. Aggregate that can scratch a copper penny without leaving any residual rock material on the coin would have a harness of 3 or more on Moh's Scale of Hardness.

(2) "Alternative private sewage system" means a system as defined in s. 145.022 (1) (a), Stats. The alternative private sewage systems included in this chapter, but not limited by enumeration, are mound systems and shallow sub-surface pressure distribution systems used on sites not meeting the soil criteria for conventional private sewage systems.

(3) "Approved" means approved or accepted by the department.

(4) "Bedrock" means the rocks that underly soil material or are at the earth's surface. Bedrock is encountered when the weathered in-place consolidated material, larger than 2 mm in size, is greater than 50% by volume.

(5) "Building" means a structure having walls and a roof erected or set upon an individual foundation or slab-constructed base designed or used for the housing, shelter, enclosure or support of persons, animals or property of any kind. A mobile home is included in this definition. Each structure abutting another structure which does not have an ingress-egress doorway through the basement foundation walls, or structures with separate exterior or exterior abutting walls, or public use structures separated by an unpierced firewall, shall be considered as a separate or individual building.

(6) "Cesspool" means a covered excavation in the ground which receives sewage or other organic wastes from a drainage system, and so designed as to retain the organic matter and solids, permitting the liquids to seep into the soil cavities.

(7) "Cleanout" means a plug or cover made of material approved by the department joined by means of a screw thread to an opening in a pipe, which can be removed for the purpose of cleaning or examining the interior of the pipe.

(8) "Clear water wastes" means cooling water and condensate drainage from refrigeration compressors and air-conditioning equipment, water used for equipment chilling purposes, liquid having no impurities or where impurities have been reduced below a minimum concentration considered harmful, and cooled condensate from steam heating systems or other equipment.

(9) "Color" means the moist color of the soil based on Munsell soil color charts.

(10) "Conventional private sewage system" means a system as defined in s. 145.022 (1) (b), Stats. Conventional private sewage systems included in this chapter are systems using a conventional soil absorption system, a system installed in a filled area approved in writing by the department, and a dosing soil absorption system.

(11) "Conventional soil absorption system" means a system that employs gravity flow from the septic or other treatment tank and applies effluent to the soil through the use of a seepage trench, bed or pit. The distribution piping is 4 inch diameter pipe.

(12) "County" means the local government unit responsible for the regulation of private sewage systems. County government is the local governmental unit responsible except that towns, villages and cities are the responsible unit of government in any county that has a population in excess of 500,000.

(13) "Department" means the department of industry, labor and human relations.

(14) "Detailed soil map" means a map prepared by or for a state or federal agency participating in the national cooperative soil survey showing soil series, type and phases at a scale of not more than 2,000 feet to the inch and includes related explanatory information.

(15) "Dosing soil absorption system" means a system that employs a pump or automatic siphon to elevate or distribute effluent to the soil through the use of a seepage trench or bed. Distribution piping in seepage trenches or beds shall be 4 inch perforated pipe approved by the department.

(16) "Dwelling unit" means one or more rooms with provisions for living, sanitary and sleeping facilities which are used or intended to be used by one person or by 2 or more persons maintaining a common household.

(17) "Effluent" means liquid discharged from a septic or other treatment tank.

(18) Failing private sewage system is defined in s. 144.24 (10) (d), Stats., as follows: "A failing private sewage system is one which causes or results in any of the following conditions:

1. The failure to accept sewage discharges and back up of sewage into the structure served by the private sewage system.
2. The discharge of sewage to the surface of the ground or to a drain tile.
3. The discharge of sewage to any waters of the state.
4. The introduction of sewage into zones of saturation which adversely affects the operation of a private sewage system."

(19) "Farm" means a parcel of 35 or more acres of contiguous land which is devoted primarily to agricultural use, as defined in s. 91.01 (1) and (5), Stats., which during the year preceeding application for a mound produced gross farm profits as defined in s. 91.09 (11) (a) 3m, Stats., of not less than \$6,000 or which during the 3 years preceeding

application produced gross farm profits, as defined in s. 91.09 (11) (a) 3m, Stats., of not less than \$18,000.

(20) "Flood fringe" means that portion of a flood plain which is outside of the floodway and which is covered by flood waters during any regional floods. It is generally associated with standing water rather than rapidly flowing water.

(21) "Flood plain" means the land which has been or may be covered by flood water during regional floods. The flood plain includes the floodway and the flood fringe.

(22) "Floodway" means the channel of a river or stream and those portions of the flood plain adjoining the channel which carry and discharge flood water or flood flows during the regional floods.

(23) "Grease interceptor" means a watertight tank which is installed underground for the collection and retention of grease from cooking or food processing and which is accessible for periodic removal of the contents.

(24) "High groundwater" means zones of soil saturation which include: Perched water tables, shallow regional groundwater tables or aquifers, or zones that are seasonally, periodically or permanently saturated.

(25) "High water level" means the highest known flood water elevation of any lake, stream, pond or flowage or the regional flood elevation established by a state or federal agency.

(26) "Holding tank" means an approved watertight receptacle for the collection and holding of sewage.

(27) "Horizontal reference point" means a stationary, easily identifiable point to which horizontal dimensions can be related.

(28) "Industrial waste" means liquid wastes which result from processes employed in industrial establishments.

(29) "Legal description" means an accurate Metes and Bounds description, a lot and block number in a recorded subdivision, a recorded assessor's plat or a public land survey description to the nearest 40 acres.

(30) "Manhole" means an opening of sufficient size to permit a person to gain access to a sewer or any portion of a plumbing system.

(31) "Mobile home" means a transportable structure mounted on a chassis and designed to be use with or without a permanent foundation as a dwelling unit. The phrase "without a permanent foundation" indicates that the support system is constructed with the intent that the mobile home thereon may be moved from time to time at the convenience of the owner. See ss. 218.10 (2) and 340.01 (29), Stats.

(32) "Mobile home park" means any plot or plots of ground owned by a person, state or local government upon which 2 or more units, occupied for dwelling or sleeping purposes regardless of mobile home ownership, are located, and whether or not a charge is made for such accommodation. See s. 66.058 (1) (i), Stats.

(33) "Nuisance" means any source of filth, odor or probable cause of sickness pursuant to the provisions of s. 146.14, Stats.

(34) "Percolation test" means the method specified in s. ILHR 83.09 (5) of testing absorption qualities of the soil.

(35) "Permeability" means the ease with which liquids move through the soil. One of the soil qualities listed in soil survey reports.

(36) "Pipe diameters" means the inside diameter.

(37) "Plumbing system" means a system as defined in s. 145.01 (1), Stats.

(38) "Potable water" means water which is satisfactory for human consumption, hygiene and culinary use and meets the requirements of the state administrative authority having jurisdiction.

(39) "Pressure distribution system" means a soil absorption system that employs a pump or automatic siphon and small diameter distribution piping with small diameter perforations to introduce effluent into the soil. Plan review and departmental approval is required for each system of this type.

(40) Private sewage system is defined in s. 145.01 (14), Stats.

(41) "Private residence" means a one or 2 family building or dwelling. See dwelling unit.

(42) "Privy" means a structure that is not connected to a plumbing system which is used by persons for the deposition of human body wastes.

(43) "Public building" means any structure, including exterior parts of such building, such as a porch, exterior platform or steps providing means of ingress or egress, used in whole or in part as a place of resort, assemblage, lodging, trade, traffic, occupancy or use by the public, or by 3 or more tenants in accord with s. 101.01 (2) (h), Stats.

(44) "Reservoir" means a watertight receptacle basin or vault constructed above the ground surface or underground for the storage of potable water.

(45) "Public garage" means a building or part of a building used for the storage of land, air or water vehicles by 3 or more persons not of the same family or habitation.

(46) "Regional flood" means as defined in ch. NR 116, Wis. Adm. Code.

(47) "Regional flood elevation" means as defined in ch. NR 116, Wis. Adm. Code.

(48) "Seepage bed" means an excavated area larger than 5 feet in width which contains a bedding of aggregate and has more than one distribution line.

(49) "Seepage pit" means an underground receptacle so constructed as to permit disposal of effluent or clear wastes by soil absorption through its floor and walls.

(50) "Seepage trench" means an area excavated one to 5 feet in width which contains a bedding of aggregate and a single distribution line.

(51) "Septic tank" means a tank which receives and partially treats sewage through processes of sedimentation, oxygenation, flotation and bacterial action so as to separate solids from the liquid in the sewage and discharges the liquid to a soil absorption system.

(52) "Sewage" means the liquid and water carried wastes created in and to be conducted away from residences, industrial establishments and public buildings.

(53) "Soil" means the unconsolidated material over bedrock.

(54) "Soil boring" means an observation pit dug by hand or backhoe, a hole dug by augering or a soil core taken intact and undisturbed with a probe.

(55) "Soil mottles" means spots or streaks of contrasting soil colors usually caused by soil saturation for some period of a normal year.

Note: Grayish colored mottles are called low chroma; reddish brown, red or yellow mottles are called high chroma.

(56) "Soil saturation" means the state when all the pores in a soil are filled with water. Water will flow from saturated soil into a bore hole.

(57) "Topsoil" means the undisturbed surface horizon of a soil often characterized by a black or dark grayish brown color due to a higher content of organic matter.

(58) "Vent cap" means an approved appurtenance used for covering the vent terminal of an effluent disposal system to avoid closure by mischief or debris and still permit circulation of air within the system.

(59) "Vertical elevation reference point" means an easily identifiable stationary point or object of constant elevation for establishing the relative elevation of percolation tests, soil borings and other locations.

(60) "Water service" means a pipe extended from the water main or private pumping system or other supply source with or without lateral extensions to the building, structure or other system to be served.

(61) "Workmanship" means work of such character that will fully secure the results sought in all the sections of this chapter as intended for the safety, welfare and health protection of all individuals.

(62) "Watercourse" means a stream usually flowing in a particular direction, though it need not flow continually, it may sometimes be dry. It must flow in a definite channel, having a bed, sides or banks, and usually discharges itself into some other stream or body of water. It must be something more than a mere surface drainage over the entire face of a tract of land, occasioned by unusual freshets or other extraordinary causes. It does not include the water flowing in the hollows or ravines in land, which is the mere surface water from rains or melting snow, and is discharged through them from a higher to a lower level, but which at other times are destitute of water. Such hollows or ravines are not in legal contemplation watercourses. (*Hoyt vs. City of Hudson* 27 Wis. 656 (1871), Wisconsin Supreme Court)

(63) MISCELLANEOUS. Standards or Specifications Abbreviations.

A.G.A. ....	American Gas Association, Inc. 420 Lexington Ave., New York, New York 10017
A.N.S.I. ....	American National Standards Institute, Inc. 1430 Broadway, New York, New York 10018
A.S.M.E. ....	American Society of Mechanical Engineers 29 W. 39th St., New York, New York 10018
A.S.S.E. ....	American Society of Sanitary Engineering 960 Illuminating Building, Cleveland, Ohio 44113
A.S.T.M. ....	American Society for Testing and Material 1916 Race St., Philadelphia, Pa. 19103
A.W.W.A. ....	American Water Works Association 2 Park Avenue, New York, New York 10016
C.S. ....	Commercial Standards, Supt. of Documents Governmental Printing Office, Washington, D. C. 20401
F.S. ....	Federal Specifications General Services Administration, Regional Office 3, Washington, D.C. 20407
M.S.S. ....	Manufacturers Standardization Society of the Valve and Fittings Industry 420 Lexington Ave., New York, New York 10017
N.S.F. ....	National Sanitation Foundation Testing Laboratory, Inc., P.O. Box 1468 Ann Arbor, Michigan 48106
U.L. ....	Underwriters' Laboratories, Inc. 207 E. Ohio Street, Chicago, Illinois 60611
W.C.F. ....	Water Conditioning Foundation 1201 Waukegan Road, Glenview, Illinois 60025

Note: For definitions of master plumber, journeyman, restricted plumbers, apprentices, registered learners and certified soil tester, refer to ch. 145, Stats.

History: Cr. Register, December, 1980, No. 300, eff. 1-1-81; renum. from H 63.02, Register, June, 1983, No. 330, eff. 7-1-83.

**ILHR 83.03 Approvals and limitations.** (1) **ALLOWABLE USE.** Septic tank and effluent absorption systems or other treatment tank and effluent disposal systems as may be approved by the department may be constructed when no public sewerage system is available to the property to be served. Unless specifically approved by the department, the private sewage system of each building shall be entirely separate from and independent of that of any other building. A private sewage system may be owned by the property owner or by a special purpose district. The use of a common system or a system on a different parcel than the structure will be subject to the same plan review procedures as for systems serving public buildings.

(2) **PUBLIC SEWER CONNECTION.** When public sewers approved by the department of natural resources become available to the premises served, the use of the private sewage system shall be discontinued within that period of time required by order, but not to exceed one year. The building sewer shall be disconnected from the private sewage system and be connected to the public sewer. All abandoned treatment tanks and seepage pits shall have the contents pumped and disposed of in accordance with ch. NR 113, Wis. Adm. Code. The top or entire tank shall be removed and the remaining portion of the tank or excavation shall be immediately filled with suitable soil material.

(3) **FAILING SYSTEM.** When a failing or malfunctioning private sewage system is encountered, the sewage disposal system shall be corrected or its use discontinued within that period of time required by county or departmental order, with a maximum time limit of one year.

History: Cr. Register, December, 1980, No. 300, eff. 1-1-81; renum. from H 63.03, Register, June, 1983, No. 330, eff. 7-1-83.

**ILHR 83.04 Specific limitations.** (1) **DOMESTIC WASTE.** All water carried wastes derived from ordinary living uses shall enter the septic or treatment tank unless otherwise specifically exempted by the department or this chapter.

(2) **CESSPOOLS.** Cesspools are prohibited.

(3) **INDUSTRIAL WASTES.** The department of natural resources shall be contacted in regard to the treatment and disposal of all industrial wastes including those combined with domestic waste.

(4) **CLEAR WATER.** The discharge of surface, rain and other clear water into a private sewage system is prohibited.

(5) **WATER SOFTENER AND IRON FILTER BACKWASH.** Water softener or iron filter discharge may be directed to the private sewage system, or to the ground surface if a nuisance is not created.

(6) **FLOODPLAIN.** (a) *General.* A soil absorption system shall not be installed in a floodway. Soil absorption systems in the flood fringe shall not be installed unless written approval is received from the department. The department shall receive written approval from the local government and the department of natural resources for construction in, and filling of, the floodplain area prior to reviewing and approving plans.

(b) *New developments.* 1. Floodway. New private sewage systems shall not be installed in a floodway.

2. Flood fringe. In the flood fringe the installation of individual private sewage systems will be reviewed on a case-by-case basis. It is preferable that with new systems that are allowed in "fringe" areas they be installed on land contiguous to land outside the flood plain limit. However, developments in isolated areas within the flood fringe may also be approved. Land areas shall be filled and thus removed from the flood plain designation. The amount of area to be filled is site dependent and will be evaluated on a site-by-site basis. Individual sites shall be checked by the county and may be checked by department staff to insure that soil conditions and other factors are in full accord with ch. NR 116, Wis. Adm. Code. The requirements of this chapter must be met before any placement of fill is authorized to overcome specific flooding conditions. The filled area for the building and the filled area for the private sewage system shall be connected. The extent and design of the fill for the sewage disposal system shall be in accord with the current rules of the department for systems in fill. [See s. ILHR 83.10 (6).] The department of natural resources will determine whether an island within a river is located in a flood plain and if it is subject to flood plain regulations.

(c) *Existing developments.* 1. Floodway. The following types of replacement systems may be allowed on a case-by-case basis to abate a health hazard in floodway areas:

a. Holding tanks that are flood-proofed in accordance with county and state flood plain standards. [See s. ILHR 83.18 (8)]

b. The installation of a replacement soil absorption system outside the flood plain limit connected to the development by a force main or to an approved acceptable site outside the floodway but in the flood fringe area. Septic tanks in the floodway shall be flood-proofed. The site must meet the requirements set forth in this chapter.

2. Flood fringe. Malfunctioning soil absorption systems may generally be replaced provided favorable soil conditions and other site factors exist.

a. County approval and acceptance shall be documented on plumbing form PLB 89 prior to state approval.

b. If filling is necessary and upon receipt of county approval, the specific design criteria and fill conditions will be stipulated for each installation in accord with this chapter.

Note: Soil absorption systems are preferable to holding tanks.

3. Processing of form PLB 89. Form PLB 89 serves as the basis for department approval of sewage disposal systems in flood plain areas. A copy of this form signed by the local authority will be submitted to the department of natural resources by the department. The county authority's signature is mandatory. Approval of a new or replacement system by the department of natural resources or the department will not be granted if the form is unsigned. The department of natural resources' approval indicated by signing form PLB 89 relates only to the accuracy of the flood plain data.

(d) *Special flood plain developments.* In certain flood plain areas where the installation of sewage disposal systems may be necessary but because of unique site conditions cannot comply with ch. NR 116, Wis. Adm. Code, or this chapter, the department of natural resources may authorize



or approve special flood plain developments provided they are in accord with the purpose and intent of ch. NR 116, Wis. Adm. Code, and county flood plain ordinances. Special developments may include but not be limited to such projects as campgrounds in flood plain areas, or the expansion of certain nonconforming uses.

History: Cr. Register, December, 1980, No. 300, eff. 1-1-81; renum. from H 63.04, Register, June, 1983, No. 330, eff. 7-1-83.

**ILHR 83.05 Local filing requirements.** (1) **SOIL TEST REPORTS.** The county shall establish a filing system for soil test reports. The county shall review soil test reports for proposed private sewage disposal systems and verify the data reported if necessary. If the soil test report is considered to be adequate, the county shall file the report.

(2) **COUNTY PLAN EXAMINATION FOR ONE AND 2 FAMILY RESIDENCES.** (a) *General.* Complete plans and specifications shall be submitted to the county with the application for sanitary permit. Plans shall be submitted on paper not less than 8½ by 11 inches in size. The county may set the number of plan copies required to adequately review the application for the sanitary permit and for the inspection of the private sewage system installation.

(b) *Plans and specifications.* All plans shall include the following:

1. Plot plan. Detailed plot plan dimensioned or drawn to scale showing the lot size; the location of all septic tanks; holding tanks or other treatment tanks; building sewers—sanitary and storm; wells; water mains or water service; streams and lakes; dosing or pumping chambers; distribution boxes; effluent systems; dual disposal systems; replacement system areas; and the location of the building served. Adjoining properties shall be checked to insure that the site location distances in s. ILHR 83.10 (1) are complied with. All separating distances and dimensions shall be shown on the detailed plot plan.

2. Reference points. A vertical elevation reference point and a horizontal reference point.

3. Soil data. Soil boring and percolation test data related to the undisturbed and finished grade elevations, vertical elevation reference point and horizontal reference point. Surface elevations shall be given for all soil borings.

4. Occupancy. The maximum number of bedrooms in the residence shall be indicated.

5. Other specifications. Complete specifications for pumps and controls including dose volume, elevation differences (vertical lift), pipe friction loss, pump performance curve, pump model and pump manufacturer.

(3) **FEES.** The county may require plan examination fees or include these fees in the cost of the sanitary permit in accord with s. 145.19 (2), Stats.

(4) **REVISED PLANS.** Every installer of a private sewage system who modifies or changes the design of a system must submit to the county authority a revised plan. All changes or modifications must be approved by the county authority prior to installation.

(5) **ACCEPTANCE.** No private sewage system shall be used until the proper sanitary permit, inspection and a revised plan, if required, has been accepted and filed by the county authority.

(6) **PLAN FILING.** The county shall establish a filing system which provides a system of retrieval of sanitary permits and plans and may set by ordinance a filing fee. The county may require that additional information be included on the plan to aid in filing, indexing or retrieving permits and plans.

History: Cr. Register, December, 1980, No. 300, eff. 1-1-81; renum. from H 63.05, Register, June, 1983, No. 330, eff. 7-1-83.

**ILHR 83.06 County administration.** (1) **PRIVATE SEWAGE SYSTEM ORDINANCE.** (a) *Adoption of ordinance.* Every county shall adopt an ordinance governing private sewage systems which conforms with this chapter. The ordinance shall apply to the entire area of the county. (Ref. s. 59.065 (1), Stats.)

(b) *Enforcement.* The county shall administer the private sewage system ordinance in accordance with s. 145.20, Stats., and this chapter.

(2) **SANITARY PERMITS.** (a) *General.* The county shall establish administrative procedures for the approval, disapproval or issuance of state sanitary permits in accord with s. 145.135, and s. 145.19, Stats., and this chapter.

(b) *Application.* The application for a sanitary permit shall be made on forms furnished by the department. Before a private sewage system is installed a licensed master plumber or master restricted plumber (sewer) shall sign the application for permit and assume responsibility for installation of the system. (Ref. ss. 145.06 and 145.135, Stats.)

(c) *Permit transfer.* When there is a change of ownership, building use or master plumber, a permit transfer form furnished by the department shall be submitted to the county for approval prior to the installation of a private sewage system. Failure to submit transfer forms to the county shall invalidate the sanitary permit in accord with s. 145.135 (1), Stats. The county may charge a fee for the transfer of a sanitary permit.

(d) *Posting.* The sanitary permit shall be issued by the county on forms furnished by the department. The sanitary permit shall be displayed conspicuously so as to be visible from the road fronting the lot during construction.

(3) **COUNTY ORGANIZATION AND PERSONNEL.** (a) *Assignment of duties.* The county board may assign the duties of administering the private sewage system program to any county office, department, committee, board, commission, position or employe.

(b) *Certified soil tester.* The county shall obtain the services of a certified soil tester, either as a county employe or under contract, to review and verify certified soil tester reports.

(4) **COUNTY RESPONSIBILITIES.** (a) *Review of soil test reports.* The county shall review certified soil tester reports for proposed private sewage systems and verify the report at the proposed site, if necessary.

(b) *Review of applications for sanitary permits.* The county shall approve or disapprove applications for sanitary permits and assist applicants in preparing an approvable application. (See s. ILHR 83.11.)

(c) *Written notice.* The county shall issue written notice to each applicant whose sanitary permit application is disapproved. Each notice shall state the specific reasons for disapproval and amendments to the application, if any, which render the application approvable. Each notice shall also give notice of the applicant's right to appeal and the procedures for conducting an appeal under ch. 68, Stats.

(d) *Inspections.* The county shall inspect all private sewage systems after construction but before backfilling no later than the end of the next workday, excluding Saturdays, Sundays and holidays, after receiving notice from the plumber in charge. Inspections shall be reported on forms furnished by the department.

(e) *Reports and surveys.* The county shall file reports and conduct surveys and inspections as required by the county or the department.

(f) *Investigate violations.* The county shall investigate violations of the private sewage system ordinance and s. 146.13, Stats., issue orders to abate the violations and submit orders to the district attorney, corporation counsel or attorney general for enforcement.

(g) *Other duties.* The county shall perform other duties regarding private sewage systems as considered appropriate by the county or as required by the rules of the department.

(5) DEPARTMENT RESPONSIBILITIES. (a) *Department approval.* The department may specify categories of private sewage systems for which approval by the department is required prior to issuance of sanitary permits by the county.

(b) *Department audit.* The department shall review the private sewage system program in each county to ascertain compliance with s. 145.20 (2), Stats., and with rules promulgated by the department. This review shall include a random audit of sanitary permits, including verification by on-site inspection.

(c) *Compliance.* If a county board does not adopt a private sewage system ordinance meeting the requirements of s. 59.065, Stats., or if the county does not appoint personnel meeting the requirements of s. 145.20 (1), Stats., or if the county does not comply with the requirements of s. 145.20 (2), Stats., the department may conduct hearings in the county seat upon 30 days notice to the county clerk. As soon as practicable after the public hearing, the department shall issue a written decision regarding compliance with s. 59.065 or 145.20 (1) and (2), Stats. If the department determines that there is a violation of these provisions, the county may not issue a sanitary permit for the installation of a private sewage system until the violation is corrected.

(d) TRAINING. The department shall conduct training and informational programs for county officials and employees and persons licensed under this chapter and s. 146.20, Stats., to improve the delivery of service under the county private sewage system program. The department

shall obtain the assistance of the Wisconsin county boards association in planning and conducting the training and informational programs.

Note: Subsections (3) to (5) is quoted directly from ch. 145, Stats.

History: Cr. Register, December, 1980, No. 300, eff. 1-1-81; renum. from H 63.06, Register, June, 1983, No. 330, eff. 7-1-83.

**ILHR 83.07 Plan review—department.** (1) APPROVALS. (a) *One and 2 family residences.* Unless required elsewhere in this chapter, the submission of plans and specifications and departmental approval of initial, modified, additional or replacement construction of private sewage systems serving one and 2 family residences is not required. All applicable plans, permits and approvals required by county government shall be obtained prior to the commencing of construction. The county government shall require plans and specifications prior to issuing permits or approval. [See s. ILHR 83.05 (2).]

(b) *Public buildings—department approval.* Complete plans and specifications shall be submitted in accord with this section. Written approval shall be received before sanitary permits are issued for the initial installation of a private sewage system or for the addition to, modification or replacement of the system, if the system serves or will serve any public buildings. The owner shall submit a copy of the approved plans to the county authority. Included as public buildings but not limited by enumeration are: Theaters and assembly halls; schools and other places of instruction; apartment buildings, hotels and places of detention; factories, office and mercantile buildings; mobile home parks, campgrounds and camping resorts and parks.

(c) *Public buildings—local approval.* Approval by the county shall not eliminate the need for approval by the department for the installation of private sewage systems serving public buildings. Departmental approval shall not eliminate the need for obtaining all required county permits and approvals.

(d) *Plan review processing time.* The department shall review and make a determination on an application for plan review within 15 business days of receiving the required information and fees.

(2) SUBMISSION OF PLANS AND SPECIFICATIONS—PUBLIC BUILDINGS. All plans and specifications shall be submitted in duplicate and shall include the following:

(a) **PLOT PLAN.** Detailed plot plan dimensioned or drawn to scale showing the lot size; the location of all septic tanks, holding tanks or other treatment tanks, building sewers—sanitary and storm, wells, water mains or water service, streams and lakes, dosing or pumping chambers, distribution boxes, effluent disposal systems, dual disposal systems, and disposal replacement areas; and the location of the public building served by such systems. Adjoining properties shall be checked to insure that the site location distances in s. ILHR 83.10 (1) are complied with. All distances and dimensions shall be shown on the detailed plot plan;

(b) *Legal description.* Legal description of the property on which the system is to be installed;

(c) *Reference points.* A vertical elevation reference point and a horizontal reference point;

(d) *Soil data.* Soil boring and percolation test data related to the undisturbed and finished grade elevations and vertical elevation reference point and horizontal reference point;

(e) *Contours—original grade.* Ground slope with 2-foot contours for the original, undisturbed grade elevation of the entire area of the soil absorption system and the area on all sides for a distance of 25 feet;

(f) *Contours—altered sites.* Ground slope with 2-foot contours for the grade elevation of the entire area of the soil absorption system and the area on all sides for a distance of 25 feet after alteration of the landscape;

(g) *Use and occupancy.* Complete data relative to the maximum expected use and occupancy of the building to be served considering all anticipated future growth plans;

(h) *Other specifications.* Complete specifications for pumps and controls including dose volume, elevation differences (vertical lift), friction loss, pump performance curve, pump model and pump manufacturer.

(3) **PLAN EXAMINATION FEE.** All plans and specifications submitted to the department for review shall be accompanied with fees as established in s. ILHR 83.08.

(4) **PLAN REVISIONS.** Revisions to approved plans and specifications shall be approved by the department.

(5) **PLAN AVAILABILITY.** One set of plans bearing the department's stamp of approval shall be maintained at the project site during construction of any private sewage system serving a public building.

*History:* Cr. Register, December, 1980, No. 300, eff. 1-1-81; renum. from H 63.07, Register, June, 1983, No. 330, eff. 7-1-83; cr. (1) (d), Register, February, 1985, No. 350, eff. 3-1-85.

**ILHR 83.08 Examination of plans and specifications.** (1) **PLAN EXAMINATION REQUIRED.** Plans and specifications for private sewage systems serving public buildings, or use of experimental or alternate type systems, or a variance to this chapter and holding tanks shall be submitted to the department and written approval received before county sanitary permits are issued or work commences. The department shall immediately acknowledge receipt of all plans and specifications. The department may issue a permit to commence work provided plan review is not completed within 30 days. The issuance of a county permit shall not be construed as plan approval or as approval for any design or installation that is noncompliant. All noncode complying portions of the plumbing and private sewage system installed prior to complete plan review shall be removed.

(2) **PLAN SUBMISSION.** (a) *Stamping and signing plans.* All plans and specifications shall be sealed or stamped in accord with ch. A-E 1, Wis. Adm. Code by a registered architect, engineer or registered plumbing designer. A master plumber may design and submit for approval plumbing plans and specifications for a private sewage system which they are to install. Each sheet of plans and specifications the master plumber submits shall be signed, dated and include their Wisconsin master plumber license number. When more than one sheet is bound together into one volume, only the title sheet or index sheet need be signed and dated by the master plumber responsible for their preparation, provided the Register, February, 1985, No. 350

signed sheet clearly identifies all of the other sheets comprising the bound volume.

(b) *Submitting data.* All plans, preliminary or complete, shall be submitted in duplicate. Work shall not commence until written approval for the preliminary or complete plans is received from the department. The plans submitted shall be prints that are clear, legible and permanent. All pertinent data shall be a part of or shall accompany all plans submitted for review. Plans will be examined in the order of receipt.

(c) *Additions and alterations.* This section shall apply to all additions, alterations and modifications as well as to all new private sewage systems and shall apply to all cases where there is a change of the type of occupancy or use of building which requires changes to or intended use of the plumbing or private sewage system so as to comply with this chapter for that occupancy or use.

(d) *Agent municipalities.* The department may designate counties as agents for the review of plans and specifications for private sewage systems serving public buildings. All requests for variances to the code or experimental or alternative private sewage system designs shall be submitted to the department for review.

(3) **PLAN EXAMINATION FEES.** Fees shall be charged in accordance with s. Ind 69.23 (2), Wis. Adm. Code.

(4) **REVISIONS.** After written approval is granted, plans and specifications of pumbing systems shall not be changed without written consent of the department and the architect, engineer, designer or master plumber responsible for the design.

(5) **LIMITATIONS.** In granting approval of plans, specifications, products, devices or materials, the department is not liable for any defects in construction, nor for any damages that may result from the specific installation.

(6) **PLAN AVAILABILITY.** The architect, professional engineer, registered designer, owner or plumbing contractor shall keep at the construction site one set of plans bearing the stamp of approval of the department.

History: Cr. Register, December, 1980, No. 300, eff. 1-1-81; r. and recr. (3), Register, June, 1982, No. 318, eff. 7-1-82; renum. from H 63.08, Register, June, 1983, No. 330, eff. 7-1-83.

**ILHR 83.09 Site evaluation.** (1) **GENERAL.** Site evaluation shall be conducted by a soil tester certified by the department in accord with ch. ILHR 81. The evaluation shall include soil conditions, properties and permeability, depth to zones of soil saturation, depth to bedrock, slope, landscape position, all setback requirements and the potential for flooding. Soil test data shall relate to the undisturbed elevations and a vertical elevation reference point or benchmark must be established. Evaluation data shall be reported on forms provided by the department and signed by the certified soil tester. Reports shall be filed for all sites investigated within 30 days of the completion of testing.

(2) **REPLACEMENT SYSTEM AREA.** (a) *General.* On each parcel of land being initially developed, sufficient area of suitable soils, based on the soil tests and system location and site requirements contained in this chapter, for one replacement system shall be established. Where bore hole test

data in the replacement system area are equivalent to that in the proposed system area, the percolation test may be eliminated.

(b) *Non-conforming site conditions.* The department shall be contacted for approval of replacement systems for all public buildings and all buildings where site conditions do not permit systems in accord with this chapter. Alternates for the disposal of effluents emanating from existing structures may be accomplished by means other than those outlined in this chapter provided written local approval is obtained and submitted along with detailed plans and specifications to the department for review and consideration. Written approval shall be received from the department prior to the county issuing permits or work commences on these systems.

(c) *Undisturbed site.* The replacement system area shall not be disturbed to the extent that it is no longer a suitable system area. The replacement system area shall not be used for the following:

1. Construction of buildings;
2. Parking lots or parking areas;
3. Below ground swimming pools;
4. Any other use that may adversely affect the replacement area.

(3) **SLOPE.** (a) *General.* A conventional soil absorption system shall not be located on a land slope of greater than 20%. A conventional soil absorption system shall be located at least 20 feet from the crown of a land slope that is greater than 20% except where the top of the aggregate of a system is at or below the bottom of an adjacent roadside ditch.

(b) *Specific system designs.* Where a more restrictive land slope is to be observed for a soil absorption system other than a conventional system, the more restrictive land slope specified in the design sections of this chapter shall apply.

(4) **SOIL BORINGS AND PROFILE DESCRIPTIONS.** (a) *General.* Soil borings shall be conducted on all sites regardless of the type of private sewage system planned to serve the parcel. Borings shall extend at least 3 feet below the bottom of the proposed system. Borings shall be of sufficient size and extent to determine the soil characteristics important to on-site liquid waste disposal. Borehole data shall be used to determine the suitability of the soils at the site with respect to zones of seasonal or permanent soil saturation, and the depth to bedrock. Borings shall be conducted prior to percolation tests to determine whether the soils are suitable to warrant percolation tests and if suitable, at what depth percolation tests shall be conducted. The use of power augers for soil borings is prohibited.

Note: Backhoe borings are preferable to borings augered or dug by hand.

(b) *Number.* There shall be a minimum of 3 suitable borings per soil absorption site. More soil borings may be necessary for accurate evaluation of a site.

1. *Depth of borings.* Borings shall be constructed to a depth of at least 3 feet below the proposed depth of the system.

2. Exceptions. On new parcels, the requirement of 6 borings (3 for initial area and 3 for replacement area) may be reduced to 5 if the initial and replacement system areas are contiguous and one boring is made on each outer corner of the contiguous area and the fifth boring is made between the system areas. See diagram.

Example Of Soil Boring Locations For

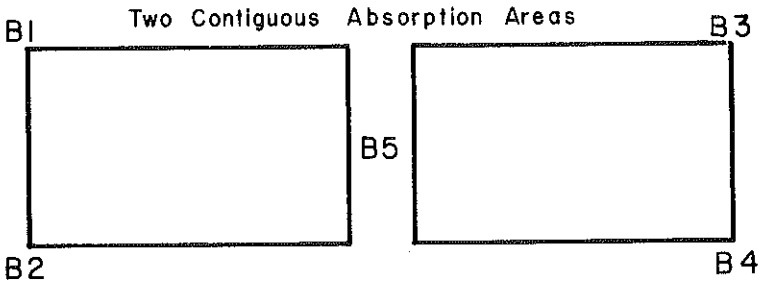

3. Reports. Regardless of the number of borings evaluated and conditions observed in borings, all soil information derived from borings shall be reported.

4. Location. Each borehole location shall be accurately located and referenced to the vertical elevation and horizontal reference point. Reports of boring locations shall either be drawn to scale, or have the horizontal dimensions clearly indicated between the borings and the horizontal reference point.

(c) *Soil description.* Soil profile descriptions shall be written for all borings. The thickness in inches of the different soil horizons observed shall be indicated. Horizons shall be differentiated on the basis of color, texture, soil mottles or bedrock. Depths shall be measured from the ground surface.

(d) *Soil mottles.* Zones of seasonal or periodic soil saturation shall be estimated at the highest level of soil mottles. The county or department may require a detailed description of the soil mottling on a marginal site. The abundance, size, contrast and color of the soil mottles should be described in the following manner.

1. Abundance. Abundance shall be described as few if the mottled color occupies less than 2% of the exposed surface; common if the mottled color occupies from 2 to 20% of the exposed surface; or many if the mottled color occupies more than 20% of the exposed surface.

2. Size. Size refers to length of the mottle measured along the longest dimension and shall be described as fine if the mottle is less than 5 millimeters; medium if the mottle is from 5 millimeters to 15 millimeters; or coarse if the mottle is greater than 15 millimeters.

3. Contrast. Contrast refers to the difference in color between the soil mottle and the background color of the soil and is described as faint if the mottle is evident but recognizable with close examination; distinct if the mottle is readily seen but not striking; or prominent if the mottle is obvious and one of the outstanding features of the horizon.

4. Color. The color(s) of the mottle(s) shall be given.



(e) *Observed groundwater.* The depth to groundwater if present shall be reported. Observed groundwater shall be reported at the level groundwater reaches in the soil borehole, or at the highest level of sidewall seepage into the boring. Measurements shall be made from ground level. Soil above the water level in the boring shall be checked for the presence of soil mottles.

(f) *Color patterns not indicative of soil saturation.* 1. One foot exception. Soil profiles that have an abrupt textural change with finer textured soils overlying more than 4 feet of unmottled, loamy sand or coarser soils can have a mottled zone in the finer textured material. If the mottled zone is less than 12 inches thick and is immediately above the textural change, then a soil absorption system may be installed in the loamy sand or coarser material below the mottled layer. If any soil mottles occur within the sandy material, then the site shall be unsuitable. The county or department may determine certain coarse sandy loam soils to be included as a coarse material.

2. Other soil color patterns. Soil mottles can occur that are not due to zones of seasonal or periodic soil saturation. Examples of such soil conditions not limited by enumeration are:

a. Soil mottles formed from residual sandstone deposits.

b. Soil mottles formed from uneven weathering of glacially deposited material, or glacially deposited material that may be naturally gray in color. This may include concretionary material in various stages of decomposition.

c. Deposits of lime in a profile derived from highly calcareous parent material.

d. Light colored silt coats deposited on soil ped faces.

e. Soil mottles that are usually vertically oriented along old or decayed root channels with a dark organic stain usually present in the center of the mottled area.

3. Reporting exceptions. A certified soil tester shall report any mottled soil condition. If soil mottles are observed that may not be due to soil saturation, the soil tester still shall report such condition and may request a determination from the department or the county authority on the acceptability of the site.

(g) *Bedrock.* The depth to bedrock except sandstone shall be established at the depth in a soil boring where greater than 50% of the weathered in-place material is consolidated. Sandstone bedrock shall be established at the depth where an increase in resistance to penetration of a knife blade occurs.

(5) PERCOLATION TESTS AND PROCEDURES. (a) *Number and location.* At least 3 percolation tests in each system area shall be conducted. The holes shall be located uniformly in the location and to the bottom depth of the proposed absorption system. More percolation tests may be necessary depending on system design.

(b) *Exemption.* Percolation tests may not be required where a detailed soil map clearly indicates loamy sand or coarser material conditions at the depth of the proposed system, and for 3 feet below and the soil condition.

tion is confirmed by soil borings. The percolation rate for design purposes shall be calculated using the slowest permeability listed in the soil survey report for the map unit. The county or department may require proof of the map findings or soil texture and resultant anticipated percolation rate. The exemption of percolation tests does not eliminate the required bore hole test data.

(c) *Percolation test hole.* The test hole shall be dug or bored. It shall have vertical sides and have a horizontal dimension of 4 to 8 inches. The bottom and sides of the hole shall be carefully scratched with a sharp pointed instrument to expose the natural soil. All loose material shall be removed from the hole and the bottom shall be covered with 2 inches of gravel or coarse sand.

(d) *Test procedure—sandy soils.* For tests in sandy soils the hole shall be carefully filled with clear water to a minimum depth of 12 inches above the bottom of the hole. The time for this amount of water to seep away shall be determined and this procedure shall be repeated. If the water from the second filling of the hole seeps away in 10 minutes or less, the test may proceed immediately as follows. Water shall be added to a point not more than 6 inches above the gravel or coarse sand. Thereupon, from a fixed reference point, water levels shall be measured at 10-minute intervals for a period of one hour. If 6 inches of water seeps away in less than 10 minutes, a shorter interval between measurements shall be used, but in no case shall the water depth exceed 6 inches. If 6 inches of water seeps away in less than 2 minutes, the test shall be stopped and a rate of less than 3 minutes per inch shall be reported. The final water level drop shall be used to calculate the percolation rate. Soils not meeting the above requirements shall be tested as in par. (e) below.

(e) *Test procedure—other soils.* The hole shall be carefully filled with clear water and a minimum water depth of 12 inches shall be maintained above the bottom of the hole for a 4-hour period by refilling whenever necessary or by use of an automatic siphon. Water remaining in the hole after 4 hours shall not be removed. Thereafter the soil shall be allowed to swell not less than 16 hours nor more than 30 hours. Immediately following the soil swelling period, the measurements for determining the percolation rate shall be made as follows. Any soil which has sloughed into the hole shall be removed and the water level shall be adjusted to 6 inches over the gravel or coarse sand. Thereupon, from a fixed reference point, the water level shall be measured at 30-minute intervals for a period of 4 hours unless 2 successive water level drops do not vary by more than  $1/16$  of an inch. At least 3 water level drops shall be observed and recorded. The hole shall be filled with clear water to a point not more than 6 inches above the gravel or coarse sand whenever it becomes nearly empty. Adjustment of the water level shall not be made during the last 3 measurement periods except to the limits of the last measured water level drop. When the first 6 inches of water seeps away in less than 30 minutes, the time interval between measurements shall be 10 minutes and the test run for one hour. The water depth shall not exceed 6 inches at any time during the measurement period. The drop that occurs during the final measurement period shall be used in calculating the percolation rate.

(f) *Mechanical test equipment.* Mechanical percolation test equipment shall be submitted to the department for approval.

(6) VERIFICATION. (a) *Borings.* Depth to soil mottles, depth to high groundwater, soil textures, depth to bedrock and land slope may be sub-

ject to verification by the county or the department. The county or the department may require backhoe pits to be provided for verification of soil boring data.

(b) *Percolation tests.* The results of percolation tests may be subject to verification by the county or the department. The county or the department may require that percolation tests be reconducted under supervision.

(c) *Filling.* Where the natural soil condition has been altered by filling or other methods used to improve wet areas, the department may require observation of high groundwater levels under saturated soil conditions.

Note: Detailed soil maps are of value for determining estimated percolation rates and other soil characteristics.

(7) **MONITORING GROUNDWATER LEVELS.** (a) *General.* A property owner or developer has the option to provide documentation that soil mottling or other color patterns at a particular site are not an indication of seasonally saturated soil conditions or high groundwater levels. Documentation shall be made by observing water levels. Monitoring shall be in accord with the following procedures.

(b) *Precipitation.* Monitoring shall be done in a near normal spring season when the precipitation received at a local station equals or exceeds, for both the periods September 1st to March 1st and March 1st to June 1st, 8.5 inches and 7.6 inches respectively. In determining whether a near normal spring occurred, where sites are subject to broad regional water tables, such as large areas of sandy soils, the fluctuation over the several year cycle shall be considered. In such cases, data obtained from the United States geological survey shall be used to determine if a regional water table was at or near its normal level.

(c) *Artificial drainage.* Areas which are to be monitored shall be carefully checked for drainage tile and open ditches which could have altered natural high groundwater levels. Where such factors are involved, information on the location, design, ownership and maintenance responsibilities for such drainage shall be provided. Documentation shall be provided to show that the drainage network has an adequate outlet, and can and will be maintained. Sites affected by agricultural drain tile shall not be acceptable for system installation.

(d) *Procedures.* 1. Soil tester. Monitoring shall be done by a certified soil tester.

2. Notification. The certified soil tester shall notify in writing, the county sanitary permit issuing authority or the department, of intent to monitor. It is expected the county authority or department may field check the monitoring at least once during the time of expected saturated soil conditions.

3. Number of wells. At least 3 wells shall be monitored at a site for a proposed system and replacement. If in the judgement of the county authority or the department more than 3 monitoring sites are needed, the certified soil tester shall be so advised in writing.

4. Monitoring well design. Monitoring wells designed as shown in the following sketch shall be constructed for monitoring. At least 2 wells shall extend to a depth of at least 6 feet below ground surface and shall be

a minimum of 3 feet below the designed system depth. However, with layered mottled soil over permeable unmottled soil, at least one well shall terminate within the mottled layer. Site conditions may, in some cases, require monitoring at greater depths. It will be the responsibility of the certified soil tester to determine the depth of the monitoring wells for each specific site and if in doubt, they shall request the guidance of the county or the department.

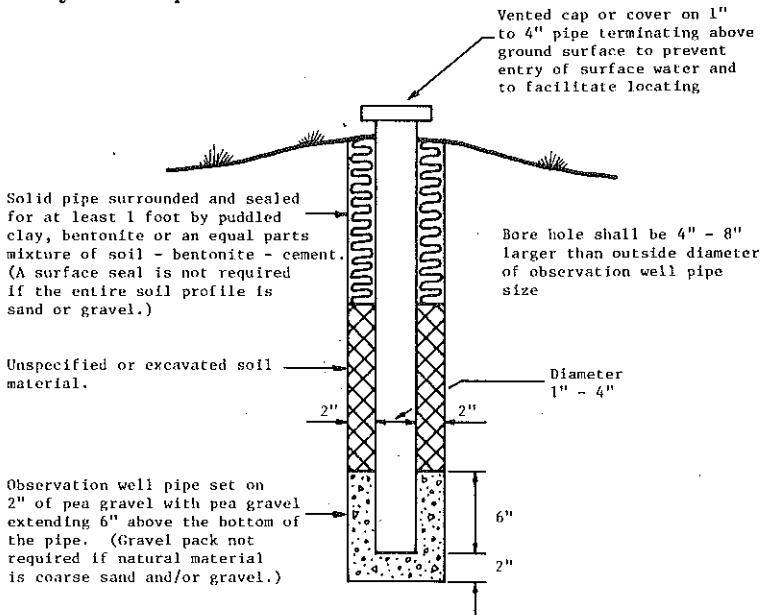

(e) *Observations.* 1. Minimum frequency. The first observation shall be made on or before March 15th. Observations shall be made thereafter every 7 days or less until June 1st or until the site is determined to be unacceptable, whichever comes first. If water is observed above the critical depth at any time, an observation shall be made 1 week later. If water is present above the critical depth at both observations, monitoring may cease because the site is considered unacceptable. If water is not present above the critical depth at the second observation, monitoring shall continue until June 1st. If any 2 observations 7 days apart show the presence of water above the critical depth, the site is unacceptable and the department shall be notified in writing.

2. More frequent interval. The occurrence of rainfall(s) of ½ inch or more in a 24 hour period during monitoring may necessitate observations at more frequent intervals.

(f) *Reporting data.* 1. Unsuccessful site. When monitoring shows saturated conditions, data giving test locations, ground elevations at the wells, soil profile descriptions, soil series if available from soil maps, dates observed, depths to observed water and local precipitation data (monthly from September 1st to June 1st and daily during monitoring) shall be submitted in writing, with 2 copies sent to the department and one to the county authority.

2. Successful site. When monitoring discloses that the site is acceptable, documentation including location and depth of test holes, ground elevations at the wells, soil profile descriptions; soil series if available from soil maps; dates observed; results of observations, local precipitation data (monthly from September 1st to June 1st and daily during monitoring) and information on artificial drainage shall be submitted in writing, with 2 copies to the department and one to the county authority. A request to install a soil absorption system shall be made to the department along with the appropriate review fee in s. ILHR 83.08 (3) (c).

(8) WINTER SOIL TESTING. (a) *General*. Soil testing should be done only when weather and light conditions make accurate evaluation of site conditions possible. Soil testing attempted under winter conditions is difficult and precautions should be observed.

(b) *Soil borings*. Soil borings and profile evaluations conducted between November 15th and March 15th shall be in accord with the following procedures. Borings shall be made with a backhoe. Soil profiles shall only be evaluated between the hours of 10:00 a.m. and 2:00 p.m. Soil profiles shall not be evaluated during times when the sky is completely overcast. When soil horizons are frozen, soil material must be thawed for hand texturing.

(c) *Percolation tests*. Percolation tests that are unprotected shall be conducted only on days when the air temperature is 20° F. or higher and the wind velocity is 10 m.p.h. or less. A heated structure or other protection from freezing shall be provided when the weather conditions listed above are not met. The bottom of the percolation hole shall be at least 12 inches below frost depth. If water freezes in the test hole at any time, the test data shall be void.

History: Cr. Register, December, 1980, No. 300, eff. 1-1-81; renum. from II 63.09, Register, June, 1983, No. 330, eff. 7-1-83.

**ILHR 83.10 Site requirements.** (1) **SOIL ABSORPTION SITE LOCATION.** The surface grade of all soil absorption systems shall be located at a point lower than the surface grade of any nearby water well or reservoir on the same or adjoining property, however, when this is not possible, the site shall be so located that surface water drainage from the site is not directed toward a well or reservoir and will by-pass the well or reservoir site by several feet. The soil absorption system shall be located not less than 5 feet from any lot line; 10 feet from a water service, or an uninhabited slab constructed building; 15 feet from a swimming pool or habitable slab constructed building measured from the slab; 25 feet from the below grade foundation of any occupied or habitable building or dwelling, public water main or cistern; 50 feet from any water well, reservoir or from the high water mark of any lake, stream or other watercourse. Private sewage systems in compacted areas such as parking lots and driveways are prohibited. Surface waters shall be diverted away from any soil absorption site on the same or neighboring lots.

(2) **GROUNDWATER, BEDROCK OR SLOWLY PERMEABLE SOILS.** There shall be a minimum of 3 feet of soil between the bottom of the soil absorption system and high groundwater, or bedrock. Soil having a percolation rate of 60 minutes per inch or faster shall exist for the depth of the proposed soil absorption system and for at least 3 feet below the proposed Register, February, 1985, No. 350

bottom of the soil absorption system. There shall be 56 inches of suitable soil from original grade for a conventional soil absorption system.

(3) **PERCOLATION RATE—TRENCH OR BED.** A subsurface soil absorption system of the trench or bed type shall not be installed where the percolation rate for any one of the 3 tests is slower than 60 minutes for water to fall one inch. The slowest percolation rate shall be used to determine the absorption area.

(4) **PERCOLATION RATE—SEEPAGE PIT.** For a seepage pit, percolation tests shall be made in each horizon penetrated below the inlet pipe. Soil strata in which the percolation rates are slower than 30 minutes per inch shall not be included in computing the absorption area. The slowest percolation rate shall be used to determine the absorption area.

(5) **SOIL MAPS.** When a parcel of land consists entirely of soils having very severe or severe limitations for on-site liquid waste disposal as determined by use of a detailed soil map and interpretive data, that map and interpretive data may be used as a basis for denial for an on-site waste disposal system. However, the property owner shall be permitted to present evidence that a suitable site for an on-site liquid waste disposal system does exist.

(6) **FILLED AREA.** (a) *Departmental approval.* A soil absorption system shall not be installed in a filled area unless written approval is received from the department except if filled prior to certification as a subdivision lot under ch. ILHR 85.

(b) *Placement of fill.* Placement of fill does not guarantee approval for the installation of a soil absorption system. When evidence is made available showing that the filled area does meet the code requirements with regard to this area, percolation and elevation; departmental approval can be expected. This, in effect, would support application for a conventional system designed in fill.

(c) *Site and soil requirements.* 1. **Bedrock.** Sites that have less than 56 inches but at least 30 inches of soil over bedrock, where the original soil texture is sand or loamy sand (sand that has very few fine particles of silt or clay), may be filled with the same soil texture as the natural soil or coarser material up to and including medium sand in an attempt to overcome the site limitations. The fill material shall not be of a finer texture than the natural soil.

2. **High groundwater.** Sites that have less than 56 inches of soil over high groundwater or estimated high groundwater, where the original soil texture is sand or loamy sand (sand that has very few fine particles of silt or clay), may be filled following the criteria noted in this subsection.

3. **Natural soil.** Sites with soils finer than sand or loamy sand shall not be approved for systems in fill.

4. **Monitoring.** Sites that will have 36 inches of soil or less above high groundwater after the topsoil is removed shall be monitored for high groundwater levels in the filled area in accordance with s. ILHR 83.09 (7).

5. **Inspection of fill.** Placement of the fill material shall be inspected by the county or the department.

## ILHR 83

(d) *Design requirements.* 1. *Size.* A filled area must be large enough to accommodate a shallow trench system and a replacement system. The size of the area that must be filled is determined by the percolation rate of the natural soil and use of the building. When any portion of the trench system or its replacement is in the fill, the fill shall extend 20 feet beyond all sides of both systems before the slope begins.

2. *Soil test.* Soil borings and percolation tests shall be conducted before filling to determine soil textures and depth to high groundwater or bedrock.

3. *Topsoil.* Vegetation and topsoil shall be removed prior to filling.

4. *Slide slope.* Slopes at the edge of the filled areas can be a maximum 3 to 1 ratio, providing the 20 foot separating distance is maintained. See following sketch.

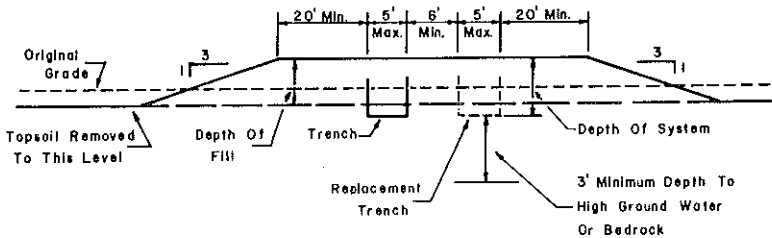

(7) **ALTERING SLOPES.** (a) *General.* In some cases, areas with slopes exceeding those specified in s. ILHR 83.09 (3) may be graded and reshaped to provide soil absorption sites. Care must be taken when altering any natural landscapes. Successful site alteration may be accomplished in accord with the following:

(b) *Site investigation.* Soil test data shall show that a sufficient depth of suitable soil material is present to provide the required amount of soil over bedrock and groundwater after alteration. In addition, a complete site evaluation as specified in s. ILHR 83.09 shall be performed after alteration of the site.

(c) *System location.* A soil absorption system must be installed in the cut area of an altered site. A soil absorption system shall not be installed in the fill area of an altered site. The area of fill on an altered site may be used as a portion of the required 20 foot separating distance from the crown of a critical slope. There shall be a minimum of 6 feet of natural soil between the edge of a system area and the downslope side of the altered area.

(d) *Site protection.* All altered slope areas shall be altered such that surface water drainage will be diverted away from the system areas. In some cases this may require the use of grassed waterways or other means of diverting surface waters. All disturbed areas shall be seeded or sodded with grass and appropriate steps must be taken to control erosion. Conceptual design sketches for altering slopes follow.

A. Excavation of complete hilltop

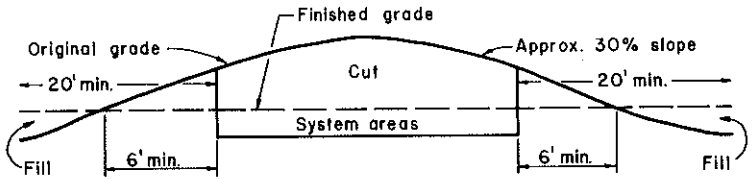

B. Excavation into hillside

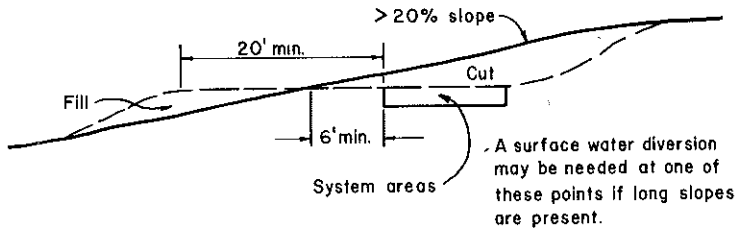

C. Regrade of hillside

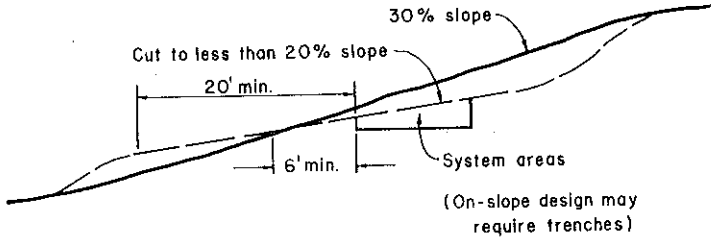

History: Cr. Register, December, 1980, No. 300, eff. 1-1-81; renum. from H 63.10 and am. (6) (a), Register, June, 1983, No. 330, eff. 7-1-83.

**ILHR 83.11 Initial adverse determination.** In all cases where property owners and/or developers receive initial adverse determinations and sanitary permits are refused by the county or the department, rejecting the use of a conventional private sewage system because of site limitation, the aggrieved party shall be given the reason, in writing, for rejection and any alternate course of actions available to them. The department shall provide to all sanitary permit issuing agents a list of alternatives which may be applied in the event conventional means of waste disposal are not acceptable.

History: Cr. Register, December, 1980, No. 300, eff. 1-1-81; renum. from H 63.11, Register, June, 1983, No. 330, eff. 7-1-83.



**ILHR 83.12 Sizing soil absorption systems.** (1) **GENERAL.** Effluent from septic tanks and other approved treatment tanks shall be disposed of by soil absorption or by such other manner approved by the department.

(a) *Daily wastewater volumes of 5,000 gallons or less.* For systems having a daily effluent application of 5,000 gallons or less, sizing shall be in accord with this section.

(b) *Daily wastewater volumes of 5,000 gallons or more.* For systems receiving effluents in excess of 5,000 gallons per day, this section shall apply except that 2 systems of equal size shall be required. Each system shall have a capacity of no less than 75% of the area required for a single system. A suitable means of alternating waste application shall be provided. The dual system shall be considered as one system.

(c) *Pressure system.* A pressure distribution network may be used in place of a conventional or dosing conventional soil absorption system where a site is suitable for a conventional private sewage system. Pressure distribution systems may be approved as an alternative private sewage system if the site is unsuitable for conventional treatment. For sizing and design criteria, see s. ILHR 83.14.

(2) **METHOD OF DISCHARGE.** (a) *Daily flow 1,500 gallons or less.* For facilities having a daily effluent application of 1,500 gallons or less, flow from the septic or treatment tank to the soil absorption system may be by gravity or by dosing.

(b) *Systems over 1,500 gallons.* For systems over 1,500 gallons, the tank effluent must be discharged by pumping or by use of an automatic siphon.

Note: The dosing of effluents is recommended for all systems.

(3) **SIZING—RESIDENTIAL.** The bottom area for seepage trenches or beds or the side wall area for seepage pits required for a soil absorption system serving residential property shall be determined from the following table using soil percolation test data and type of construction:

**Table 1**

Percolation Class	Percolation Rate Minutes Required for Water to Fall One Inch	Minimum Absorption		Area in Square Feet	
		Public Buildings		Residential Property per bedroom	
		Seepage Trenches or Pits	Seepage Beds	Seepage Trenches or Pits	Seepage Beds
Class 1	0 to less than 10	110	140	165	205
Class 2	10 to less than 30	165	205	250	315
Class 3	30 to less than 45	200	250	300	375
Class 4	45 to 60	220	280	330	415

(4) **SIZING—PUBLIC BUILDINGS.** The minimum soil absorption system area for public buildings is dependent upon building usage, the percolation rate and the system design. Tables 1 and 2 shall be used to calculate the required area. The following formula shall be used: (Factor in Column 3, Table 2) x (Number of units) x (Min. Absorption Area from Table 1).

Table 2

COLUMN 1	COLUMN 2	COLUMN 3
Building Classification	Units	Factor
Apartment building.....	1 per bedroom.....	1.5
Assembly hall—no kitchen.....	1 per person.....	0.02
Bar and cocktail lounge.....	1 per patron space.....	0.2
Beauty salon.....	1 per station.....	2.4
Bowling alley.....	1 per bowling lane.....	2.5
Bowling alley with bar.....	1 per bowling lane.....	4.5
Camp, day use only.....	1 per person.....	0.2
Camp, day and night.....	1 per person.....	0.45
Campground and camping resort.....	1 per camping space.....	0.9
Campground and sanitary dump station.....	1 per camping space.....	0.085
Car wash (automatic).....	Subject to state approval	
Car wash (per car handwash).....	1 per car.....	1.0
Catch basin—garages, service stations, etc.....	1 per basin.....	2.0
Catch basin—truck wash.....	1 per truck.....	5.0
Church—no kitchen.....	1 per person.....	0.04
Church—with kitchen.....	1 per person.....	0.09
Condominium.....	1 per bedroom.....	1.5
Country club.....	Subject to state approval	
Dance hall.....	1 per person.....	0.06
Dining hall—kitchen and toilet.....	1 per meal served.....	0.2
Dining hall—kitchen only.....	1 per meal served.....	0.06
Dining hall—kitchen and toilet waste with dishwasher and/or food waste disposer.....	1 per meal served.....	0.25
Drive-in restaurant (all paper service).....	1 per car space.....	0.3
Drive-in restaurant (inside seating).....	1 per seat.....	0.3
Drive-in theater.....	1 per car space.....	0.1
Employees—in all buildings.....	1 per person.....	0.4
Hotel or motel and tourist rooming house.....	1 per room.....	0.9
Floor drain.....	1 per drain.....	1.0
Hospital.....	1 per bed space.....	2.0
Medical office buildings, clinics and dental offices.....		
Doctors, nurses and medical staff.....	1 per person.....	0.8
Office personnel.....	1 per person.....	0.25
Patients.....	1 per person.....	0.15
Migrant labor camp—central bathhouse.....	1 per employe.....	0.25
Mobile home (single installation).....	(Use ILHR 83.12 (3) )	
Mobile home park.....	1 per mobile home site.....	3.0
Nursing or rest homes.....	1 per bed space.....	1.0
Outdoor sports facility—toilet waste only.....	1 per person.....	0.085
Park—toilet waste only.....	1 per acre.....	4.0
Park—showers and toilets.....	1 per acre.....	8.0
Restaurant—kitchen waste only.....	1 per seating space.....	0.18
Restaurant—toilet waste only.....	1 per seating space.....	0.42
Restaurant—kitchen and toilet.....	1 per seating space.....	0.6
Restaurant—(24-hr) kitchen and toilet.....	1 per seating space.....	1.2
Restaurant—diswasher and/or food waste disposer.....	1 per seating space.....	0.15
Restaurant—(24-hr) with dishwasher/dispenser.....	1 per seating space.....	1.5
Retail store.....	1 per customer.....	0.03
(Number of customers = 70% total area divided by 30 square feet/customer.)		
Self-service laundry—toilet wastes only.....	1 per machine.....	1.0
Auto washer (service bldgs., etc.).....	1 per machine.....	6.0
Service station.....	1 per car served.....	0.15

Table 2 (continued)

COLUMN 1	COLUMN 2	COLUMN 3
Building Classification	Units	Factor
Swimming pool bathhouse .....	1 per person .....	0.2
School—no meals, no showers .....	1 per classroom .....	5.0
School—meals served or showers .....	1 per classroom .....	6.7
School—meals and showers .....	1 per classroom .....	8.0
Showers—public .....	1 per shower .....	0.3

History: Cr. Register, December, 1980, No. 300, eff. 1-1-81; renum. from H 63.12, Register, June, 1983, No. 330, eff. 7-1-83.

**ILHR 83.13 Installation—conventional soil absorption systems.** (1) **SEEPAGE TRENCH EXCAVATIONS.** Seepage trench excavations shall be 1 to 5 feet in width. Trench excavations shall be spaced at least 6 feet apart. The absorption area of a seepage trench shall be computed by using the bottom area only. The bottom area of the distribution header excavation shall not be computed as absorption area. Individual seepage trenches should not be over 100 feet long.

(2) **SEEPAGE BED EXCAVATIONS.** Seepage bed excavations shall be more than 5 feet wide and have more than one distribution pipe. The absorption area of a seepage bed shall be computed by using the bottom area only. Distribution piping in a seepage bed shall be uniformly spaced, no more than 6 feet and no less than 3 feet apart, and no more than 3 feet or less than 1 foot from the sidewall.

(3) **SEEPAGE PITS.** A seepage pit shall have a minimum inside diameter of 5 feet and shall consist of a chamber walled-up with material such as perforated precast concrete ring, concrete block, brick or other material approved by the department which allows effluent to percolate into the surrounding soil. The pit bottom shall be left open to the soil. Aggregate of ½ to 2½ inches in size shall be placed into a 6-inch minimum annular space separating the outside wall of the chamber and sidewall excavation. The depth of the annular space shall be measured from the inlet pipe to the bottom of the chamber. Each seepage pit shall be provided with a 24-inch manhole extending to within 6 inches of the ground surface and a 4-inch diameter fresh air inlet which shall meet the requirements of sub. (7). An observation pipe is not required. Seepage pits shall be located 6 feet or more apart. Excavation and scarifying shall be in accord with sub. (4). The effective area of a seepage pit shall be the vertical wall area of the walled-up chamber for the depth below the inlet for all strata for which the percolation rates are less than 30 minutes per inch. The 6 inches of annular opening outside the vertical wall area may be included for determination of effective area. Table 3 may be used for determining the effective sidewall area of circular seepage pits:

Table 3

## EFFECTIVE ABSORPTION AREA FOR SEEPAGE PITS

Inside diameter of chamber in feet plus 1 foot for wall thickness plus one foot for annular space	Depth in feet of Permeable Strata Below Inlet					
	3	4	5	6	7	8
7.....	75	101	126	151	176	201
8.....	85	113	142	170	198	226
9.....	94	126	157	188	220	251
10.....	104	138	173	208	242	277
12.....	123	163	204	245	286	327

(4) **EXCAVATION AND CONSTRUCTION.** The bottom of a trench or bed excavation shall be level. Seepage trenches or beds shall not be excavated when the soil is so wet that soil material rolled between the hands will form a soil wire. All smeared or compacted soil surfaces in the side walls or bottom of the seepage trench or bed excavation shall be scarified to the depth of smearing or compaction and the loose material removed. If rain falls on an open excavation, the soil must be left until dry enough that a soil wire will not form when soil from the excavation bottom is rolled between the hands. The bottom area shall then be scarified and loose material removed.

(5) **AGGREGATE AND BACKFILL.** A minimum of 6 inches of aggregate ranging in size from  $\frac{1}{2}$  to  $2\frac{1}{2}$  inches shall be laid into the trench or bed below the distribution pipe elevation. The aggregate shall be evenly distributed a minimum of 2 inches over the top of the distribution pipe. The aggregate shall be covered with synthetic materials approved by the department or with 9 inches of uncompacted marsh hay or straw. Building paper shall not be used to cover the aggregate. A minimum of 18 inches of soil back fill shall be provided above the covering.

(6) **DISTRIBUTION PIPING.** (a) *General.* Distribution piping for gravity systems shall be a minimum of 4 inch I.D. approved pipe. The distribution header shall be constructed of approved solid wall pipe. The top of the distribution piping shall be laid 8 to 42 inches below the original surface in continuous straight or curved lines. The slope of the distribution pipes shall be 2 to 4 inches per 100 feet.

(b) *Distribution of effluent.* Effluent should be distributed equally to all distribution pipes. Distribution of effluent to seepage trenches on sloping sites may be accomplished by utilizing a drop box design. Where dosing is required, the siphon or pump shall discharge a dose of minimum capacity equal to 75% of the combined volume of the distribution piping in the absorption system. See s. ILHR 83.12 (1) (b).

(7) **FRESH AIR INLETS AND OBSERVATION PIPE.** Fresh air observation inlets of cast iron shall be provided and connected to the perforated distribution pipe with an approved fitting or junction box and be placed so as to assure a free flow of air throughout the entire installation. The vent pipes shall be at least 4 inches in diameter and extend at least 12 inches above the final grade and terminate with an approved vent cap. The observation pipe shall be perforated and extend to the bottom of the aggregate. See following sketch. Fresh air inlets shall be located at least 25 feet from any window, door or air intake of any building used for human habitation. A maximum of 4 distribution pipe lines may be served by one common 4-inch vent when interconnected by a common header pipe.

## Fresh Air Inlets And Observation Pipe

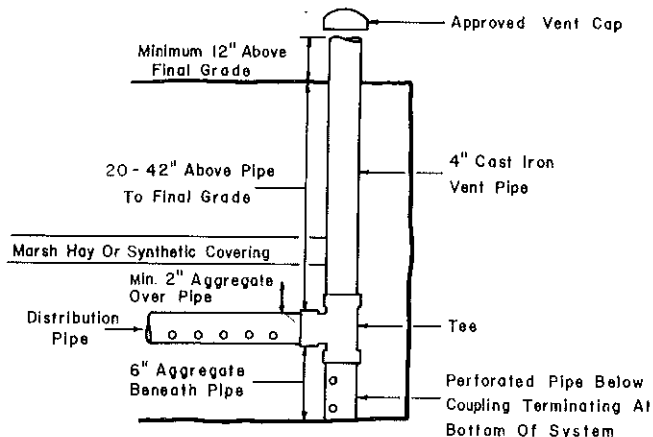

(8) WINTER INSTALLATION. (a) *General*. Installation of soil absorption systems during periods of adverse weather conditions is not recommended. A soil absorption system shall not be installed if the soil at the system elevation is frozen.

(b) *Removal of snow cover*. Snow cover must be removed from the soil absorption area before excavation begins. Snow must not be placed in a manner that will cause water to pond on the soil absorption system area during snowmelt.

(c) *Excavated and backfill material*. Excavated soil material may be used as backfill for the system if the following conditions are met: The excavated material must be protected from freezing. If the excavated material freezes solid, it shall not be used as backfill. The first 12 inches of backfill shall be loose, unfrozen soil. The protective covering over the bed or trench gravel shall be a synthetic material approved by the department or 9 inches of uncompacted marsh hay or straw.

(d) *System inspection*. Inspection of systems installed during winter conditions shall include inspection of the trench or bed excavation prior to placement of gravel and inspection of backfill material at the time of placement.

**History:** Cr. Register, December, 1980, No. 300, eff. 1-1-81; renum. from H 63.13, Register, June, 1983, No. 330, eff. 7-1-83.

**ILHR 83.14 Pressure distribution systems.** (1) **GENERAL.** A pressure distribution system may be used on any site meeting the conventional private sewage system criteria listed in s. ILHR 83.10. A pressure distribution system may be approved as an alternative private sewage system under s. ILHR 83.22. There shall be a minimum depth to the top of the distribution piping of 6 inches from original grade for any pressure distribution system approved as an alternative private sewage system. The minimum required suitable soil depths from original grade for an alter-

Register, February, 1985, No. 350

native private sewage system using a pressure distribution network are as follows:

- 1 inch distribution pipe—49 inches suitable soil
- 2 inch distribution pipe—50 inches suitable soil
- 3 inch distribution pipe—52 inches suitable soil
- 4 inch distribution pipe—53 inches suitable soil

Department approval is required for use of a pressure distribution system.

(2) **ABSORPTION AREA.** (a) *Sizing.* The total absorption area required shall be computed from the estimated daily wastewater flow and the design loading rate. The required absorption area equals wastewater flow divided by the design loading rate from Table 4.

(b) *Estimating wastewater flow.* 1. Residential. The estimated wastewater flow from a residence shall be 150 gallons per bedroom per day.

2. Public buildings. Daily wastewater flow rates for public buildings shall be based on the usage factors listed in s. ILHR 83.15 (3) (c) 2.

(c) *Design loading rate.* The design loading rate for a site is based on the percolation rate for the site. Table 4 shall be used to determine the design loading rate.

**Table 4**

**DESIGN LOADING RATE TABLE**

Percolation Rate	Design Loading Factor
0 to less than 10 min/in	1.2 gal/sq ft/day
10 to less than 30 min/in	.8 gal/sq ft/day
30 to less than 45 min/in	.72 gal/sq ft/day
45 to 60 min/in	.4 gal/sq ft/day

(3) **PRESSURE DISTRIBUTION SYSTEM DESIGN.** (a) *General.* Pressure distribution systems may discharge effluent into trenches or beds. Each pipe that is connected to an outlet of a manifold shall be counted as a separate distribution pipe. The horizontal spacing of distribution pipes shall be 30 to 72 inches. (See following sketch.) All distribution piping should be installed at the same elevation, or the plans and specifications shall provide for a design that insures equal flow through each of the perforations.

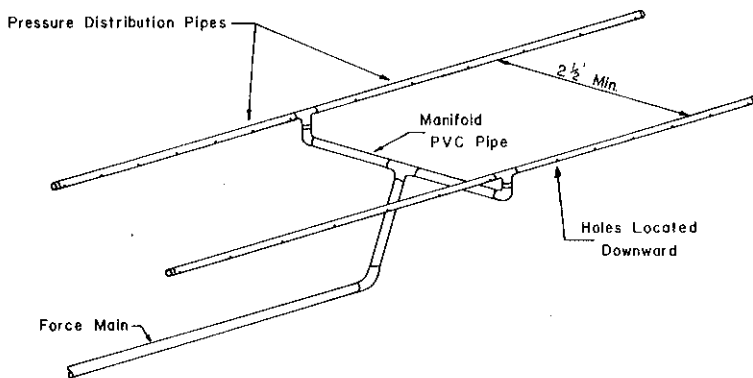

— Bed Design Is Recommended Over Trenches

(b) *Design calculations.* Pressure distribution systems requiring less than 5,000 square feet of absorption area shall be designed using Tables 5 through 11. Systems requiring more than 5,000 square feet of absorption area shall be designed using design specifications and calculations other than those specified in Tables 5 through 11. Design specifications and calculations must be submitted and include perforation discharge rate, total headloss through the distribution piping, headloss through manifold piping, pump or siphon size and dosing volume. Formulas for these calculations may be obtained from the department.

(c) *Distribution pipe size.* Distribution pipe diameters may vary depending on the length of bed or trenches. Table 5 specifies maximum allowable distribution pipe lengths for various pipe and perforation sizes.

(d) *Manifolds.* 1. Size. The size of the manifold is based on the number, length and discharge rate of the distribution pipes. Table 6 shall be used for calculating distribution pipe discharge rate. Table 7 shall be used for calculating manifold diameter.

2. Distribution pipe connection. Distribution pipes should be connected to the manifold with tee's or 90° ells. Distribution pipes shall have the ends capped.

(e) *Force main.* The size of the force main between the pump and the manifold shall be based on the friction loss and velocity of effluent through the pipe. Force mains shall be constructed of approved pipe.

(4) **BED AND TRENCH CONSTRUCTION.** (a) *General.* The excavation and construction requirements for pressure distribution system trenches and beds shall meet the requirements specified in s. ILHR 83.13 (1), (2), (4), (5), (8).

(b) *Aggregate.* Aggregate shall be placed to a minimum depth of 6 inches beneath the distribution pipe with 2 inches spread evenly above the pipe. The aggregate shall be clean, non-deteriorating 1/2 to 2 1/2 inch stone.

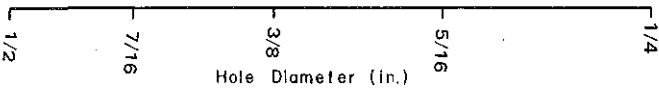
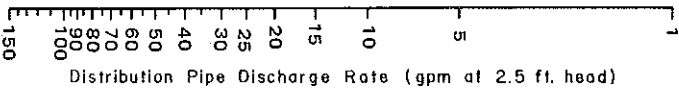
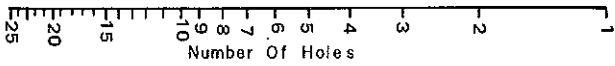
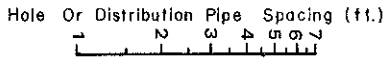
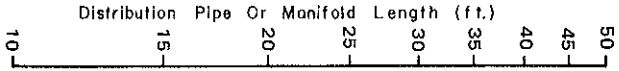

Table 6



Table 5 : Required Distribution Pipe Diameters For Various Hole Diameters, Hole Spacings  
And Distribution Pipe Lengths (for plastic pipe only)

Distribution Pipe Length (ft.)	Distribution Pipe Diameter (in.)													
	1/4		5/16		3/8		7/16		1/2		3/4		1	
	Hole Diameter (in.)	Hole Spacing (ft.)	Hole Diameter (in.)	Hole Spacing (ft.)	Hole Diameter (in.)	Hole Spacing (ft.)	Hole Diameter (in.)	Hole Spacing (ft.)	Hole Diameter (in.)	Hole Spacing (ft.)	Hole Diameter (in.)	Hole Spacing (ft.)	Hole Diameter (in.)	Hole Spacing (ft.)
10	1"		1"		1"		1"		1"		1"		1"	
15	1"		1"		1"		1"		1"		1"		1"	
20	1"		1"		1"		1"		1"		1"		1"	
25	1"		1"		1"		1"		1"		1"		1"	
30	1 1/2"		1 1/2"		1 1/2"		1 1/2"		1 1/2"		1 1/2"		1 1/2"	
35	1 1/2"		1 1/2"		1 1/2"		1 1/2"		1 1/2"		1 1/2"		1 1/2"	
40	2"		2"		2"		2"		2"		2"		2"	
45	2"		2"		2"		2"		2"		2"		2"	
50	2 1/2"		3"		3"		3"		3"		3"		3"	



(c) *County inspection.* The county inspector shall inspect pressure systems at the time the aggregate is started to be placed and while the distribution piping is being installed.

(5) PUMPS AND PUMP CONTROLS. (a) *Pump selection.* Pump selection is to be based on the pump performance curve. The total dynamic head shall be equal to:

1. Elevation. The elevation difference between the pump and distribution pipe invert.

2. Friction loss. The friction loss in the pipe between the pump and the supply end of the distribution pipe.

3. Head. A head at the supply end of the distribution pipe of 2.5 feet.

4. Dynamic head. Total dynamic head equals elevation head plus friction loss plus 2.5 feet of supply end head.

(b) *Discharge rate.* Table 8 shall be used to determine pump dosing rate based on the distribution pipe discharge rate and number of distribution pipes.

(c) *Friction loss.* Table 9 is the friction loss chart for schedule 40 plastic pipe ( $C = 150$ ). The diameter of the pipe shall be increased if the velocity falls in the excessive range based upon flow rates in Table 9.

(d) *Pump and alarm controls.* 1. General controls. The control system for the pumping chamber shall consist of a control for operating the pump and an alarm system to detect when the pump is malfunctioning. Pump controls should be selected which give flexibility in adjusting the on/off depth. All pump and alarm controls shall be approved by the department. Pressure diaphragm switches shall not be used. The following types of controls may be used.

a. Mercury level control. Mercury level control switches consist of a mercury switch sealed inside a bulb. Strictly an on/off switch, 2 are required.

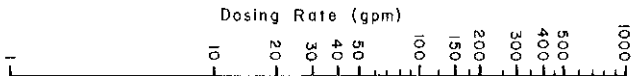
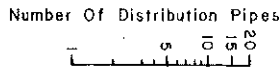
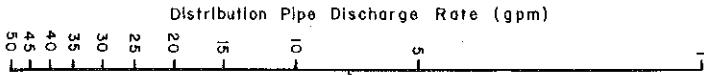

Table 8

**Table 9**  
**FRICITION LOSS IN SCHEDULE 40 PLASTIC PIPE (C = 150)**

Flow	Pipe Diameter (in)								
	1	1-1/4	1-1/2	2	3	4	6	8	10
	gpm				ft/100 ft				
1	0.07								
2	0.28	0.07							
3	0.60	0.16	0.07						
4	1.01	0.25	0.12						
5	1.52	0.39	0.18						
6	2.14	0.55	0.25	0.07					
7	2.89	0.76	0.36	0.10					
8	3.63	0.97	0.46	0.14					
9	4.57	1.21	0.58	0.17					
10	5.50	1.46	0.70	0.21					
11		1.77	0.84	0.25					
12		2.09	1.01	0.30					
13		2.42	1.17	0.35					
14		2.74	1.33	0.39					
15		3.06	1.45	0.44	0.07				
16		3.49	1.65	0.50	0.08				
17		3.93	1.86	0.56	0.09				
18		4.37	2.07	0.62	0.10				
19		4.81	2.28	0.68	0.11				
20		5.23	2.46	0.74	0.12				
25			3.75	1.10	0.16				
30			5.22	1.54	0.23				
35				2.05	0.30	0.07			
40				2.62	0.39	0.09			
45				3.27	0.48	0.12			
50				3.98	0.58	0.16			
60					0.81	0.21			
70					1.08	0.28			
80					1.38	0.37			
90					1.73	0.46			
100					2.09	0.55	0.07		
125						0.85	0.12		
150						1.17	0.16		
175						1.56	0.21		
200							0.28	0.07	
250							0.41	0.11	
300							0.58	0.16	
350							0.78	0.20	0.07
400							0.99	0.26	0.09
450							1.22	0.32	0.11
500								0.38	0.14
600								0.54	0.18
700								0.72	0.24
800									0.32
900									0.38
1000									0.46

b. Adjustable weight switch. Adjustable weight switches consist of a control located above the water level and 2 weights attached to a single cable which extends into the liquid.

2. Alarm system. The alarm system shall consist of a bell or light mounted in the structure and shall be located so it can be easily seen or heard. The high water warning device shall be installed 2 inches above the depth set for the on pump control. Alarm systems shall be installed on a separate circuit from the electrical service.

3. Electrical connections. Electrical connections shall be located outside the pumping chamber. All wiring to the pump chamber shall be installed in a conduit.

(6) DOSING. The dosing frequency shall be a maximum of 4 times daily. To establish the volume per dose, divide the daily wastewater flow by the dosing frequency. In addition, the dosing volume shall be at least 10 times the capacity of the distribution pipe volume. Table 10 provides the void volume for various pipe diameters. Table 11 shall be used to determine minimum dose volume based on distribution pipe diameter, length and number of distribution pipes.

Table 10  
 VOID VOLUME FOR VARIOUS DIAMETER PIPES

Diameter inch	Volume gal/ft length
1	.041
1 ¼	.064
1 ½	.092
2	.164
3	.368
4	.655
6	1.47

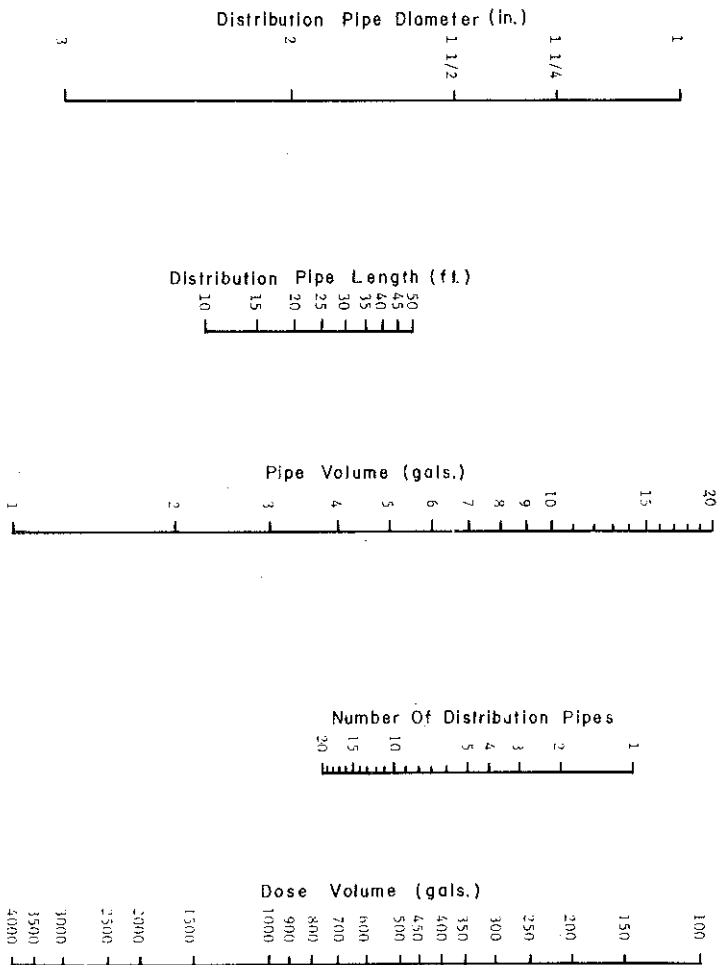

Table II

History: Cr. Register, December, 1980, No. 300, eff. 1-1-81; renum. from H 63.14, Register, June, 1983, No. 330, eff. 7-1-83.

**ILHR 83.15 Septic tanks and other treatment tanks. (1) GENERAL.** Septic tanks shall be fabricated or constructed of welded steel, monolithic concrete, fiberglass or other materials approved by the department. All tanks shall be watertight and fabricated so as to constitute an individual structure. The design of prefabricated septic tanks shall be approved by the department. Plans for site-constructed concrete tanks shall be approved by the department prior to construction.

**(2) DESIGN OF SEPTIC TANKS. (a) Liquid depth.** The liquid depth shall not be less than 3 feet nor more than an average of 6 feet. The total depth shall be at least 8 inches greater than the liquid depth.

(b) *Rectangular tanks.* Rectangular tanks shall have a minimum width of 36 inches and shall be constructed with the longest dimensions parallel to the direction of flow.

(c) *Cylindrical tanks.* Cylindrical tanks shall have an inside diameter of not less than 48 inches.

(d) *Label.* Each prefabricated tank shall be clearly marked to show liquid capacity and the name and address or registered trade mark of the manufacturer. The markings shall be impressed into or embossed onto the outside wall of the tank immediately above the outlet opening. Each site-constructed concrete tank shall be clearly marked at the outlet opening to show the liquid capacity. The marking shall be impressed into or embossed onto the outside wall of the tank immediately above the outlet opening.

(e) *Materials.* For septic tank material and construction specifications, see s. ILHR 83.20.

(f) *Inlet and outlet.* The inlet and outlet on all tanks or tank compartments shall be provided with open-end coated sanitary tees or baffles made of approved materials, so constructed as to distribute flow and retain scum in the tank or compartments. The inlet and outlet openings on all tanks shall contain a "boss" stop or other provision which will prevent the insertion of the sewer piping beyond the inside wall of the tank. The tees or baffles shall extend at least 6 inches above and 9 inches below the liquid level, but not to exceed  $\frac{1}{2}$  the liquid depth. At least 2 inches of clear space shall be provided over the top of the baffles or tees. The bottom of the outlet opening shall be at least 2 inches lower than the bottom of the inlet.

(g) *Manholes.* Each single-compartment tank and each unit of a multi-compartment tank shall be provided with at least one manhole opening located either over the inlet or outlet opening, no less than 24 inches square or 24 inches in diameter. Manholes shall terminate a maximum of 6 inches below the ground surface and be of the same material as the tank. Steel tanks shall have a minimum 2-inch collar for the manhole extensions permanently welded to the tank. The manhole extension on fiberglass tanks shall be of the same material as the tank and an integral part of the tank. The collar shall have a minimum height of 2 inches.

(h) *Manhole covers.* Manhole risers must be provided with a substantial, fitted, watertight cover of concrete, steel, cast iron or other material approved by the department. Manhole covers which terminate above grade shall have an effective locking device which meets with department approval. A 4 x 6 inch label printed in red or other contrasting color must be affixed to the cover warning of the hazards present when entering a septic tank. The wording used on the warning label shall be approved by the department as part of the materials approval for the tank.

(i) *Inspection opening.* An airtight inspection opening which may be either a manhole or a cast iron pipe at least 4 inches in diameter, shall be provided over either the inlet baffle or outlet baffle which does not have the manhole above it for all treatment tanks. The upper end of the inspection pipe shall terminate 6 inches above final grade.

(3) CAPACITY AND SIZING. (a) *Minimum capacity.* The capacity of a septic tank or other treatment tank shall be based on the number of per-



sons using the building to be served or upon the volume and type of waste. The minimum liquid capacity shall be 750 gallons.

(b) *Multiple tanks.* When the required capacity is to be provided by more than one tank, the minimum capacity of any tank shall be 750 gallons. When 3 or 4 tanks are installed, approval of the design of the system shall be obtained from the department. The installation of more than 4 tanks in series is prohibited. Installation of septic tanks in parallel is prohibited.

(c) *Sizing of tank.* 1. Residential. The minimum liquid capacity for one and 2 family residences is as follows:

SEPTIC TANK CAPACITY ONE AND TWO FAMILY RESIDENCES

Number of Bedrooms	Septic Tank
1.....	750
2.....	750
3.....	975
4.....	1,200
5.....	1,425
6.....	1,650
7.....	1,875
8.....	2,100

2. Public buildings. For buildings other than one and two family residences the liquid capacity shall be increased above the 750-gallon minimum as established in Table 12. For such buildings having kitchen and/or laundry waste, the tank capacity shall be increased to receive the anticipated volume for a 24-hour period from the kitchen and/or laundry. The liquid capacities established in Table 12 do not include employees.

Table 12

Apartment buildings (per bedroom—includes auto washer).....	150 gals.
Assembly hall (per person—no kitchen).....	2 gals.
Bars and cocktail lounges (per patron space).....	9 gals.
Beauty salons (per station—includes customers).....	140 gals.
Bowling alley (per alley).....	125 gals.
Bowling alley with bar (per alley).....	225 gals.
Campgrounds and camping resorts (per camp space).....	100 gals.
Campground sanitary dump stations (per camp space).....	5 gals.
(omit camp spaces with sewer connection)	
Camps, day use only—no meals served (per person).....	15 gals.
Camps, day and night (per person).....	40 gals.
Car wash (automatic)—subject to state approval	
Car wash (per car handwash).....	50 gals.
Catch basins—garages, service stations, etc.(per basin, etc.).....	100 gals.
Catch basins—truck washing (per truck).....	100 gals.
Churches—no kitchen (per person).....	3 gals.
Churches—with kitchen (per person).....	7.5 gals.
Condominiums (per bedroom—includes auto washer).....	150 gals.
Country clubs—subject to state approval	
Dance halls (10 sq. ft. per person).....	3 gals.
Dining hall—kitchen and toilet waste—with dishwasher and/or with disposer(per meal served).....	11 gals.
Dining hall—kitchen waste only (per meal served).....	3 gals.
Drive-in restaurants—all paper service (per car space).....	15 gals.
Drive-in restaurants—all paper service inside seating (per seat).....	15 gals.
Drive-in theaters (per car space).....	5 gals.
Employee—in all buildings, per employee—total all shifts.....	20 gals.
Floor drain (per drain).....	50 gals.
Hospitals (per bed space).....	200 gals.

Hotels or motels and tourist rooming houses (per room—2 persons per room) .....	100 gals.
Medical office buildings, clinics and dental offices .....	
Doctors, nurses, medical staff (per person) .....	75 gals.
Office personnel (per person) .....	20 gals.
Patients (per person) .....	10 gals.
Migrant labor camp, central bathhouse (per employe) .....	30 gals.
Mobile homes, single installation (use ILHR 83.15 (3) (c) 1)	
Mobile home parks, homes with bathroom groups (per site) .....	300 gals.
Nursing and rest homes—without laundry (per bed space) .....	100 gals.
Outdoor sport facilities (toilet waste only—per person) .....	5 gals.
Parks, toilet wastes (per person—75 persons per acre) .....	5 gals.
Parks, with showers and toilet wastes (per person—75 persons per acre)	
Restaurant—kitchen waste only—without dishwasher and/or disposer (per seat) .....	9 gals.
Restaurant—toilet waste only (per seat) .....	21 gals.
Restaurant—kitchen and toilet wastes (per seating space) .....	30 gals.
Restaurant (24-hr)—kitchen and toilet wastes (per seating space) .....	60 gals.
Restaurant—dishwasher and/or food waste disposer (per seat) .....	3 gals.
Restaurant (24-hr)—dishwasher and/or food waste disposer (per seat) ...	6 gals.
Retail store—customers .....	1.5 gals.
(Number of customers = 70% total area divided by 30 square feet/customer.)	
Schools (per classroom—25 pupils per classroom) .....	450 gals.
Schools with meals served (per classroom—25 pupils per classroom) .....	600 gals.
Schools with meals served and showers provided (per classroom) .....	750 gals.
Self-service laundries (toilet waste only, per machine) .....	50 gals.
Auto washer (apartments, service buildings, etc.—per machine) .....	300 gals.
Service stations (per car) .....	10 gals.
Showers—public (per shower taken) .....	15 gals.
Swimming pool bathhouses (per person) .....	10 gals.

(4) **INSTALLATION.** (a) *Location.* Septic and other treatment tanks shall not be located within 5 feet of any building or its appendage, water service, 2 feet of any lot line, 10 feet of any cistern, 15 feet of any pool, 25 feet of any well, reservoir or high water mark of any lake, stream, pond or flowage, within the interior foundation walls of a building nor shall a new building or addition to an existing building be constructed or located over or within 5 feet of a tank.

(b) *Groundwater.* If the tank is installed in groundwater, adequate anchoring provisions shall be made.

(c) *Bedding.* A 3-inch thick compacted bedding shall be provided for all septic and other treatment tank installations. The bedding material shall be sand, gravel, granite, limerock or other noncorrosive materials of such size that 100% will pass a ½-inch screen.

(d) *Backfill.* 1. Steel and fiberglass tanks. The backfill material for steel and fiberglass tanks shall be as specified for bedding and shall be tamped into place, care being taken to prevent damage to the coating.

2. Concrete tanks. The backfill for concrete tanks shall be soil material, 100% of which shall pass a 4-inch screen and shall be tamped into place.

(e) *Piping.* The inlet and outlet piping between a septic or other treatment tank and points 3 feet beyond the undisturbed ground surrounding the excavation made to install each tank and all piping connecting tanks shall be cast iron pipe or other pipe approved by the department for the specific purpose. The piping 3 feet beyond the undisturbed ground on the outlet side of the septic tank shall comply with the materials specified in s. ILHR 84.30 (1) (c). The joints between

pipe and tank openings shall be made with lead and oakum or other methods approved by the department.

(f) *Manhole riser joints.* 1. Concrete. All joints on concrete risers and manhole covers shall be tongue and groove or shi lap type and sealed watertight using neat cement, mortar or bituminous compound.

2. Steel. All joints on steel risers shall be welded or flanged and bolted and be watertight. All steel manhole extensions shall be bituminous coated inside and outside.

3. Fiberglass. All methods of attaching fiberglass risers shall be watertight and approved by the department.

(5) **DOSING OR PUMPING CHAMBERS.** (a) *Material and construction.* Dosing or pumping chambers shall be fabricated or constructed of welded steel, monolithic concrete, glass-fiber reinforced polyester or other approved materials. Manholes for dosing or pumping chambers shall terminate a minimum of 4 inches above the ground surface. All dosing or pumping chambers shall be watertight and materials and construction specifications must meet the same criteria specified for septic tanks in this section.

(b) *Capacity sizing.* The working capacity of the dosing or pumping chamber shall be sized to permit automatic discharge of the total daily sewage flow with discharge occurring no more than 4 times per 24 hours. The minimum capacity of a dosing chamber shall be 500 gallons. Dosing or pumping chambers shall be provided with a minimum 4-inch cast iron vent extended at least 12 inches above final grade and terminate with an approved vent cap and be a minimum of 25 feet from a door, window or fresh air intake. A dosing chamber shall have a 1-day holding capacity above the high water alarm for residences, based on 100 gallons per day per bedroom, or in the case of public buildings in accordance with sub. (3). Table 13 lists minimum pump chamber sizes for residences.

Table 13  
PUMP CHAMBER SIZES

Home Size No. Bedrooms	Minimum Pumping Chamber Size Gallons
1	500
2	500
3	500 - 750
4	500 - 750
5	750 - 1,000

(6) **DESIGN OF OTHER TREATMENT TANKS.** The design of other treatment tanks shall be considered on an individual basis. A complete description of the method of treatment to be performed in the treatment tank plus 3 complete sets of plans shall be submitted to the department for each request for approval of the treatment tank. The installation of the tank shall be commenced only upon receipt of written approval by the department. The capacity, sizing and installation of the tank shall be according to subs. (3) and (4) unless the department specifies different sizing or installation requirements in its written approval of the treatment tank. The department may require such treatment tanks to be pre-

ceded by a conventional septic tank. Credit will be given for the capacity of the septic tank in meeting the required capacity as listed in sub. (3).

**History:** Cr. Register, December, 1980, No. 300, eff. 1-1-81; renum. from H 63.15, Register, June, 1983, No. 330, eff. 7-1-83; am. (4) (e), Register, February, 1985, No. 350, eff. 3-1-85.

**ILHR 83.16 Maintenance and sludge disposal.** (1) **MAINTENANCE.** Septic tanks and other treatment tanks shall be cleaned whenever the sludge and scum occupies  $\frac{1}{4}$  of the tank's liquid capacity. All sludge, scum, liquid and any other material removed from a private domestic sewage treatment and disposal system is hereafter referred to as sludge.

(2) **SLUDGE DISPOSAL.** See ch. NR 113, Wis. Adm. Code.

(3) **COUNTY OPTION.** Counties may establish a mandatory maintenance program to insure continuing maintenance of private sewage systems.

**History:** Cr. Register, December, 1980, No. 300, eff. 1-1-81; renum. from H 63.16, Register, June, 1983, No. 330, eff. 7-1-83.

**ILHR 83.17 Chemical restoration.** No products for chemical restoration or chemical restoration procedures for private sewage systems may be used unless approved by the department.

**History:** Cr. Register, December, 1980, No. 300, eff. 1-1-81; renum. from H 63.17, Register, June, 1983, No. 330, eff. 7-1-83.

**ILHR 83.18 Holding tanks.** (1) **APPROVAL.** The use of holding tank installations will be considered on an individual basis. Plans and appropriate fees must be submitted as required in s. ILHR 83.08 to the department for review of each request to install a holding tank. The department shall have the responsibility for the review and approval of holding tanks when the tanks are located on private property. Where holding tanks are connected to a public collection system and located in the public right-of-way or are owned and pumped by a governmental entity with an easement for access, the bureau of water quality of the department of natural resources shall be responsible for plan review and approval.

(2) **PROHIBITING HOLDING TANKS.** Holding tanks for new construction may be prohibited by county ordinance. If the county allows the use of holding tanks for new construction, then such use may be prohibited by city, village, or town ordinance. If a governmental unit prohibits holding tanks for new construction, then the governmental unit shall provide an appeal procedure to this prohibition. The county board, city council, village board or town board or the designated committee of such governmental unit, may grant variances to their holding tank prohibition. The county, city, village or town shall inform the department in writing of each variance.

(3) **HOLDING TANKS ON PROPERTIES WITH EXISTING BUILDINGS.** When the use of a holding tank becomes the only available alternative for the disposal of sanitary liquid waste for an existing building, local government shall allow the use of a holding tank or condemn the property. The requirements established for use of holding tanks for newly developed properties in this section shall also apply to replacement system uses.

(4) **NEWLY DEVELOPED PROPERTIES.** (a) *General.* A signed agreement between the appropriate city, village or town and the owner guaranteeing the pumping and transporting of the holding tank contents to a

disposal site meeting the requirements of ch. NR 113, Wis. Adm. Code, shall be submitted to the department. The agreement shall specify that if the owner does not cause to have the holding tank properly maintained in response to orders from local government or the department, and it becomes necessary to prevent or abate a nuisance as described in ss. 146.13 and 146.14, Stats., local government shall provide for pumping and transporting of the holding tank contents. The agreement shall also include the requirement that a quarterly pumping report be submitted by the owner or their agent to the local government and the county which shall state the owner's name, location of the property on which the holding tank is located, the pumper's name, the dates, volumes pumped and the disposal site. An annual pumping report or the fourth quarter report including a summary of the pumping history of the previous year shall be submitted to the department by local or county government. The agreement shall be binding on the owners, their heirs and assignees and recorded in cognizant with the deed.

(b) **HOLDING TANKS IN SUBDIVISIONS.** The following procedures shall be followed when creating lots by subdividing and using holding tanks and the hauling of waste as the means of liquid waste disposal.

1. A local governmental entity shall be responsible for proper waste hauling. In the case of a township, a sanitary district shall be in existence.

2. The properties to be served shall be described in detail—including plat name.

3. When a private waste hauler is to be used, a contract between local government and the liquid waste hauler shall be submitted to the department. In the case of townships, the sanitary district shall have a contract with the liquid waste hauler.

4. If hauling of the waste is to be performed by local government or a sanitary district, a copy of the action purchasing the hauling equipment and authorization of employes to perform the work shall be submitted to the department.

5. A copy of the contract between the sanitary district or private haulers and a local governmental entity operating the sewage treatment facility receiving the hauled waste shall be submitted to the department if final disposal is accomplished in that manner.

6. A letter from the department of natural resources authorizing disposal into a public treatment facility shall be supplied to the department if final disposal is accomplished in that manner. If disposal is to the ground surface, the department of natural resources shall indicate that the disposal site meets the requirements of NR 113, Wis. Adm. Code.

7. If the subdivision is given clearance under ch. 236, Stats., as a sewered subdivision, the department of natural resources shall be the approving authority for the holding tank installation.

(5) **SIZING.** (a) *One and 2 family residences.* The minimum liquid capacity of a holding tank for one and 2 family residences is as follows:

Number of Bedrooms	Holding Tank
1	2,000
2	2,000
3	2,000
4	2,500
5	3,000
6	3,500
7	4,000
8	4,500

(b) *Public buildings.* Public buildings shall have a minimum 5-day holding capacity, but not less 2,000 gallons. Sizing shall be based in accord with s. ILHR 83.15 (3) (c) 2. The 750 gallon minimum referred to in s. ILHR 83.15 (3) does not apply to holding tanks. No more than 4 holding tanks installed in series will be permitted.

(6) **CONSTRUCTION.** Holding tanks shall be constructed of welded steel, monolithic concrete, glass-fibre reinforced polyester or other materials approved by the department.

(7) **INSTALLATION.** (a) *Location.* Tanks shall be located in accord with s. ILHR 83.15 (4) (a), except the tanks shall be at least 20 feet from any part of a building. Holding tanks shall be so located to an all-weather access road or drive so that the pumper may drive pumping equipment to within 10 feet of the servicing manhole.

(b) *Warning device.* A high water warning device shall be installed so that it activates 1 foot below the inlet pipe. This device shall be either an audible or illuminated alarm. If the latter, it shall be conspicuously mounted. Electrical junction box, including warning equipment junctions, shall be located outside the holding tank unless they are housed in waterproof, explosion-proof enclosures. Electrical relays or controls shall be located outside the holding tank.

(c) *Manholes.* Each tank shall be provided with a manhole opening no less than 24 inches square or 24 inches inside diameter extending to a minimum of 4 inches above ground. Finish grade must be sloped away from the manhole to divert surface water from the manhole. Each manhole cover shall have an effective locking device. Manhole covers may have a service port reduced in size to 8 inch inside diameter 4 inches above finish grade level. The reduced opening must have an effective locking cover or a brass cleanout plug. Reduced locking devices or cleanouts must be approved by the department.

(d) *Septic tank.* If an approved septic tank is installed to serve as a holding tank, the inlet and outlet baffle may be removed and the outlet shall be sealed.

(e) *Vent.* Each tank shall be provided with a minimum 2-inch cast iron fresh air inlet extending 12 inches above final grade, terminating with a return bend fitting and 25 feet from a door, window or fresh air inlet. When a 4-inch cast iron vent is used, the above requirements shall apply except it may terminate with an approved vent cap.

(f) *Servicing.* Holding tanks shall be serviced in accord with ch. 146, Stats., and ch. NR 113, Wis. Adm. Code.

(8) **FLOOD PLAIN CONSTRUCTION.** (a) *Vent.* Two feet of freeboard between the top of the vent of the holding tanks and the regional flood elevation is required.

(b) *Manhole.* Two feet of freeboard is required between the top of the service manhole of a holding tank and the regional flood elevation.

(c) *Anchoring.* Adequate anchoring of a holding tank must be provided to counter the buoyant forces in the event of a regional flood.

**History:** Cr. Register, December, 1980, No. 300, eff. 1-1-81; renum. from H 63.18, Register, June, 1983, No. 330, eff. 7-1-83.

**ILHR 83.19 Inspection and tests. (1) INITIAL INSPECTION PROCEDURES.**

(a) *General.* All private sewage systems shall be inspected after construction but before backfilling no later than the end of the next workday excluding Saturdays, Sundays and holidays after receiving notice from the licensed plumber responsible for the installation, i.e., the plumber in charge.

(b) *Notice for inspection.* The plumber in charge shall notify the county in person, by telephone or in writing when the private sewage system is ready for inspection.

(c) *Preparation for inspection.* When a private sewage system is ready for inspection, the plumber in charge shall make such arrangements as will enable the county or department inspector to inspect all parts of the system. The plumber shall have present the proper apparatus and equipment for conducting the inspection and shall furnish such assistance as may be necessary in making proper inspection.

(2) **COVERING OF WORK.** No part of the private sewage system may be backfilled until has been inspected and approved. If any part is covered before being inspected and approved it shall be uncovered at the discretion of the county or department inspector.

(3) **OTHER INSPECTIONS.** The county or department may require additional inspections other than the inspection prior to backfilling. Inspections may be required during the construction phase and after backfilling.

(4) **INSPECTIONS FOR ADDITIONS, ALTERATIONS OR MODIFICATIONS.** When a private sewage system is modified, altered or additions constructed, the inspection criteria required in this section shall apply.

(5) **DEFECTS IN MATERIALS AND WORKMANSHIP.** If inspection discloses defective material, design, siting or unworkmanlike construction which does not conform to the requirements of this chapter, the nonconforming parts shall be removed, replaced and reinspected.

**History:** Cr. Register, December, 1980, No. 300, eff. 1-1-81; renum. from H 63.19, Register, June, 1983, No. 330, eff. 7-1-83.

**ILHR 83.20 Materials. (1) MINIMUM STANDARDS.** (a) *Approval.* Unless otherwise provided for in this chapter, all materials, fixtures or devices sold, used or entering into the construction of a private sewage system or parts thereof, shall be submitted to the department for approval and shall conform to approved applicable standards or to other equivalent standards acceptable to the department and shall be free from defects.

Register, February, 1985, No. 350

(b) *Identification.* Each length of pipe and each pipe fitting, fixture, material and device used in a private sewage system shall have cast, embossed, stamped or indelibly marked on it the maker's mark or name, the weight and quality of the product or identified in accord with the applicable approved standard. All materials and devices used in the construction of a private sewage system or parts thereof shall be marked and identified in a manner satisfactory to the department.

(c) *Conformance.* Standards listed or referred to in this section cover materials which shall conform to the requirements of this chapter when used in accordance with the limitations imposed in this chapter. Designs and materials for special conditions or materials not provided for herein may be used only after the department has been satisfied as to their adequacy and granted approval.

Note: Chapter ILHR 84 contains accepted and approved plumbing materials and the applicable standards.

(d) *Alterations.* In existing buildings or premises in which plumbing installations are to be altered, repaired or renovated, the department has discretionary powers to permit deviation from the provisions of this chapter provided that such a proposal to deviate is first submitted to the department for proper determination and approval.

(e) *Tests.* The department may require tests to be made or repeated, if at any time, there is reason to believe that any material or device no longer conforms to the requirements on which its approval was based.

(2) **MATERIAL STANDARDS.** Each material listed in Table 32 of s. ILHR 82.19, shall conform to at least one of the standards opposite it. Products conforming to one or more of the specifications listed shall be considered acceptable subject to limitations specified. See s. ILHR 83.02 (63) for a list of abbreviations. For materials not listed, consult the department.

(3) **PRECAST CONCRETE AND SITE CONSTRUCTED TANKS.** (a) Precast concrete tanks shall have a minimum wall thickness of 2 inches.

(b) *Materials.* The concrete used in constructing a precast or site-constructed tank shall be a mix to withstand a compressive load at least 3,000 pounds per square inch. All concrete tanks shall be designed to withstand the pressures to which they are subjected.

(c) *Joints.* The floor and sidewalls of a site-constructed concrete tank shall be monolithic except a construction joint will be permitted in the lower 12 inches of the sidewall of the tank. The construction joint shall have a keyway in the lower section of the joint. The width of the keyway shall be approximately 30% of the thickness of the sidewall with a depth equal to the width. A continuous water stop or baffle at least 6 inches in width shall be set vertically in the joint, embedded  $\frac{1}{2}$  its width in the concrete below the joint with the remaining width in the concrete above the joint. The water stop or baffle shall be copper, neoprene, rubber or polyvinylchloride designed for this specific purpose. Joints between the concrete septic tank and its cover and between the septic tank cover and manhole riser shall be tongue and groove or shiplap type and sealed watertight using neat cement, mortar or bituminous compound.

(4) **STEEL SEPTIC TANKS.** For general tank design see s. ILHR 83.15. Steel tanks shall be fabricated of new, hot rolled commercial steel. The tanks including cover with rim, inlet and outlet collars and manhole ex-



tension collars shall be fabricated with welded joints in such a manner as to provide structural stability and water tightness. Steel tanks shall be coated, inside and outside in compliance with U.L. Standard 70 Bituminous Coated Metal Septic Tanks. Any damage to the bituminous coating shall be repaired by recoating. The gauge of the steel shall be as follows:

## SEPTIC TANK CAPACITY

## Tank Design

## Vertical Cylindrical

500 thru 1,000 gallons.....	Bottom and sidewalls	14 ga	None
.....	Cover	12 ga	
.....	Baffles	12 ga	
1,001 thru 1,250 gallons.....	Complete tank	10 ga	None
1,251 thru 1,500 gallons.....	Complete tank	7 ga	None

## Horizontal Cylindrical

500 thru 1,000 gallons.....	Complete tank	13 ga	54" dia
1,001 thru 1,500 gallons.....	Complete tank	12 ga	64" dia
1,501 thru 2,500 gallons.....	Complete tank	10 ga	76" dia
2,501 thru 9,000 gallons.....	Complete tank	7 ga	76" dia
9,001 thru 12,000 gallons.....	Complete tank	1/4" plate	None
12,001 or more gallons.....	Complete tank	5/16" plate	None

(5) FIBERGLASS SEPTIC TANKS. (a) *General*. The following paragraphs apply to septic tanks made of glass-fiber reinforced polyester and intended for use in nonindustrial private sewage systems. For general septic tank design see s. ILHR 83.15. Unless otherwise indicated, the plastic terminology used in this section is in accordance with the definitions given in ASTM Standard D 883.

(b) *Materials*. Septic tanks, covers, baffles, flanges, manholes, etc., shall be made from polyester resins with glass-fiber reinforcement and meet the general design criteria as prescribed in s. ILHR 83.15 (1).

(c) *Resin*. The resin shall be a commercial grade of polyester resin and shall be evaluated as a laminate by tests conducted in accordance with ASTM Standard C 581. Unless otherwise approved by the department the same resin shall be used throughout the laminate.

(d) *Reinforcing material*. The reinforcing material shall be of a suitable commercial grade of glass-fiber (E Glass) treated with a coupling agent, approved by the glass-fiber manufacturer, that will provide a compatible bond between the resin and the glass. Glass-fiber surfacing materials, if used, shall be of a chemical-resistant glass (C glass) bonded with a suitable binder.

(e) *Fillers and pigments*. The resins used shall not contain fillers except as required for viscosity control. Up to 5% by weight of the total resin content of thixotropic agent that will not interfere with visual inspection may be added to the resin for viscosity control. Resins may contain pigments and dyes recognizing that such additions may interfere with visual inspection of laminate quality.

(f) *Laminate.* The laminate shall consist of the following: Primary chemical resistant surface; internal anti-wicking barrier; additional structural reinforcing section if required to meet the properties described in par. (h) and the following table; and exterior surface. (See following sketch.)

1) Primary Chemical-Resistant Surface						2) Internal Anti-Wicking Barrier					
1)	2)	2)	3)	3)	3)	3)	3)	3)	3)	3)	4)
						To Desired Thickness For Strength					
3) Additional Structural Reinforcing Section						4) Exterior Surface					

(g) *Primary chemical resistant surface.* This surface shall be between 0.005 and 0.012 inch thick. It shall be a reinforced resin-rich surface. It shall be free from cracks and crazing and have a smooth finish.

(h) *Internal anti-wicking barrier.* Not less than 0.100 inch of chemical resistant laminate next to the inner surface shall be reinforced with not less than 20% or more than 30% by weight of mat or chopped strand.

(i) *Additional structural reinforcing sections.* This layer or body or the laminate shall be of chemically resistant construction suitable for the intended use and providing the additional strength necessary to meet the tensile and flexural requirements. When separate layers such as mat, cloth or woven roving are used, all layers shall be lapped at least one inch. Laps shall be staggered as much as possible. If woven roving or cloth is used, layers of chopped strand glass shall be placed as alternate layers.

(j) *Exterior surface.* This surface shall consist of a chopped strand glass over which shall be applied a resin-rich coating. This resin-rich surface layer shall contain less than 20% of reinforcing material.

(k) *Cut edges.* All cut edges shall be coated with resin so that no glass fibers are exposed and all voids are filled. Structural elements having edges exposed to the chemical environment shall be made with chopped strand glass reinforcement only.

(l) *Wall thickness.* The minimum wall thickness shall be as recommended by the manufacturer but in no case shall it be less than 3/16 inch regardless of operating conditions. Isolated small areas may be as thin as 80% of the specified minimum wall thickness.

(m) *Mechanical properties.* To establish proper wall thickness and other design characteristics, the minimum physical properties for any laminate shall be as shown in the following table and par. (n) below.

REQUIREMENTS FOR PROPERTIES OF NEWLY FABRICATED  
REINFORCED POLYESTER LAMINATES

Property at 73.4°F. in psi (MPa)*	Thickness in inches				Test Method
	3/16	1/4	5/16	3/8 & up	
Ultimate tensile strength, min.	9,000 (62)	12,000 (83)	13,500 (93)	15,000 (103)	ASTM D 638
Flexural strength, min.	16,000 (110)	19,000 (131)	20,000 (137)	22,000 (152)	ASTM D 790
Flexural modulus of elasticity (tangent), min.	700,000 (4823)	800,000 (5512)	900,000 (6201)	1,000,000 (6895)	ASTM D 790

\*(MPa) = mega pascals

(n) *Surface hardness.* The laminate shall have a Barcol hardness of at least 90% of the manufacturer's minimum specified hardness for the cured resins when tested in accordance with ASTM D 2583. This requirement applies to both interior and exterior surfaces.

(o) *Appearance.* The finished laminate shall be as free as commercially practicable from visual defects such as foreign inclusions, dry spots, air bubbles, pinholes, pimples and delamination. The inner surface shall be free from cracks and crazing and have a smooth finish and an average of not more than 2 pits per square foot providing the pits are less than 1/8 inch diameter and not more than 1/32 inch deep and are covered with sufficient resin to avoid exposure of inner surface fabric. Some waviness is permissible provided the surface is smooth and free from pits. Unless otherwise specified, ASTM D 2563 visual acceptance level 3 shall be the minimum standard for acceptance.

(p) *Tank design.* All tanks shall meet the general design criteria as outlined in s. ILHR 83.15 (1) and (2). Horizontal cylindrical tanks standard end enclosed shall be convexed heads with a maximum radius of curvature equal to the tank diameter. Rectangular tanks shall have external ribs to prevent sidewall deflection exceeding 1/2% of span at any location when tested by filling with water.

(q) *Shell joints.* Where tanks are manufactured in sections and joined by use of a laminate bond, the joint shall be glass-fiber reinforced resin at least the thickness of the heaviest section being joined. The reinforcement shall extend on each side of the joint a sufficient distance to make the joint at least as strong as the tank wall, and shall be not less than the minimum joint widths specified in the following table. The reinforcement shall be applied both inside and out, with the inner reinforcement considered as a corrosion resistant barrier only and not structural material.

MINIMUM TOTAL WIDTHS OF OVERLAYS FOR  
REINFORCED-POLYESTER TANK SHELL JOINTS

Tank wall thickness in inches	3/16	1/4	5/16	3/8	7/16	1/2	9/16	5/8	11/16	3/4
Minimum outside overlay width in inches	4	4	5	6	7	8	9	10	11	12
Minimum inside overlay width in inches	4	4	5	5	6	6	6	6	6	6

(r) *Resistance to static load.* There shall be not more than 0.25% difference in dimensions before and after the tanks are statically loaded. For the static load test bed an empty tank in dry sand to a depth not exceeding 4 inches and oriented as in service. Load top segment of empty tank with evenly distributed load to a total weight in pounds equal to:

$$L = 140 \times A_1 \times b \quad \text{where } L = \text{total load}$$

$$A_1 = \text{horizontal cross-sectional area of tank}$$

$$b = \text{depth of overburden expected}$$

Rotate tank through 90° on its major axis. Bed tank in dry sand to a depth not exceeding 4 inches. Load sides of empty tank with evenly distributed load to total weight in pounds equal to:

$$L = 70 \times A_2 \times b \quad \text{where } L = \text{total load}$$

$$A_2 = \text{vertical cross-sectional area of tank}$$

$$b = \text{depth of overburden expected}$$

(s) *Siphoning or pumping.* There shall be no permanent deflection or change in length of any internal or external component of the tank during the pumping or siphoning when the tank is filled to its working level. There shall be no signs of leaking, weeping or other failure.

(t) *Weight.* No tank shall differ in gross weight by more than +10 or -5% from the weight of tanks that have been subjected to the tests for siphoning and static pressure.

(u) *Tests.* Tensile strength test shall be in accordance with ASTM D 638, except that the specimens shall be the actual thickness of the fabricated article and the width of the reduced section shall be one inch. Other dimensions of specimens shall be as designated by the ASTM standard for type one specimens for materials over 1/2 inch to one inch inclusive. Specimens shall not be machined on the surface. Test 5 specimens at 0.20 to 0.25 inch/minute crosshead speed, and average the results. Flexural strength shall be determined in accordance with Procedure A and Table 1 of ASTM D 790, except that the specimens shall be actual thickness of the fabricated article and the width shall be one inch. Other dimen-

## ILHR 83

sions of specimens shall be as designated by the ASTM standard. Specimens shall not be machined on the surface. Test 5 specimens, with the resin-rich side in compression. Determine the tangent modulus of elasticity in flexure by ASTM D 790.

(6) **ALTERNATE AND EXPERIMENTAL MATERIALS.** (a) *Intent.* The provisions of this chapter are not intended to prevent the use of any alternate material provided the material has first been approved and its use authorized by the department.

(b) *Approval.* The department may approve an alternate or experimental material in accord with s. 145.02 (2) (b), Stats., provided the proposed alternate or the experimental concepts are satisfactory and comply with the intent of this chapter.

(c) *Evidence or proof.* The department shall require that sufficient evidence or proof be submitted to substantiate any claims that may be made regarding the sufficiency of any proposed material.

(d) *Tests and standards.* Tests shall be made in accord with approved standards but in the absence of such standards, the department shall specify the test procedure.

(e) *Repeating tests.* The department may require tests to be made or repeated if at any time there is reason to believe that any material no longer conforms to the requirements on which its approval is based.

*History:* Cr. Register, December, 1980, No. 300, eff. 1-1-81; renum. from H 63.20, Register, June, 1983, No. 330, eff. 7-1-83; r. and recr. (1) (c), Register, February, 1985, No. 350, eff. 3-1-85.

**ILHR 83.21 Building sewers and drains.** (1) **GENERAL.** Building sewers which terminate in a septic tank shall meet the same general criteria as listed in s. ILHR 82.30, except where specified in this section. All sanitary or special type drainage systems shall be connected by means of independent connections with a public sewer, approved private interceptor main sewer or private sewage system.

(2) **COVER.** Building sewers which terminate in a septic tank shall not be less than 18 inches from the top of the pipe to finished grade.

(3) **MATERIALS.** All building sewers which terminate in a septic tank shall be constructed of cast iron, vitrified clay, concrete, asbestos cement, plastic or bituminous fiber pipe or other materials approved by the department. The pipe from the septic tank to the soil absorption area shall be constructed of solid wall pipe approved by the department as specified in ch. ILHR 84.

*History:* Cr. Register, December, 1980, No. 300, eff. 1-1-81; renum. from H 63.21, Register, June, 1983, No. 330, eff. 7-1-83; am. (1) and (3), Register, February, 1985, No. 350, eff. 3-1-85.

**ILHR 83.22 Alternative private sewage systems.** (1) **GENERAL.** Alternative private sewage systems shall be considered acceptable for use when the site, soil and system design criteria specified in s. ILHR 83.23 (1) and 83.14 (1) are met. Their installation shall be limited to the numbers specified in s. 145.022, Stats. A trial program shall terminate 5 years after the date of the start of a trial program. If the institutional control aspects specified as part of this section prove satisfactory at the end of a 5 year monitoring and assessment period, controlled use shall cease.

Register, February, 1985, No. 350

(2) **REPLACEMENT SYSTEMS.** (a) *Number.* There shall be no limit on the number of alternative private sewage systems installed as replacements for existing systems that have failed or are failure-prone.

(b) *Failure-prone system.* A failure-prone system shall be a holding tank or privy installed and in use prior to February 1, 1980.

(c) *Verification.* The existence of a failed or failure-prone system shall be verified in writing by the county.

(3) **NEW CONSTRUCTION.** (a) *Limitation.* In accord with s. 145.022, Stats., the number of alternative private sewage systems for new construction installed each calendar year in the state may not exceed 3% of the number of private sewage systems installed during the previous year. The number of alternative private sewage systems installed in any county in a calendar year may not exceed 5% of the total number of alternative private sewage systems allowed in the state for that year.

(b) *Exceptions.* The percent limitations in this section shall not apply to sites for which an approval is issued in the following manner:

1. Applications for approval had been completed and were on file with the department on February 1, 1980.

2. To individual lots for which a sanitary permit was issued under ch. ILHR 83, for a conventional system by the department or local permit issuing authority but later ruled unsuitable due to new or changed soil criteria being established by the department.

3. To one additional second homesite on a farm to be occupied by a parent, child, sibling, grandchild, niece, nephew or first cousin who will be a primary or co-operator of the farm.

4. To lots meeting the site criteria for a conventional private sewage system.

Note: New soil condition criteria promulgated by the department is limited to 1) the existence of soil having a percolation rate of 60 minutes per inch or faster for the depth of the proposed soil absorption system and for 3 feet below the bottom of the system and 2) the presence of a few faint high chroma mottles in some glacial tills or clean sandy soils.

(c) *Verification.* The property owner requesting an exception shall submit a copy of an official document from the county having authority that indicates which exception the property is effected by. The exception shall be reported on forms furnished by the department.

(d) *Applicability.* The limitation, exceptions and verification shall apply to an individual lot and not to the owner of the property. Except for persons applying before February 1, 1980, more than one approval for new construction shall not be issued to any one individual.

(e) *Records.* The department and the county shall maintain an accurate record of the requests for approval received. The record shall include the date received; the property location; the name of the owner, soil tester and designer; and the type of private sewage system. Requests received over the number allowed in a county or in the state shall be carried over by the county in order to the next year.

(4) **INSTITUTIONAL CONTROLS.** (a) *General.* The institutional controls in effect during previous trial periods as enumerated in this subsection shall be continued for the 5 year controlled use period.

1. Application. Application for a mound approval shall be made on a form supplied by the department.

2. On-site inspection. Each proposed alternative private sewage system site shall be inspected for soil characteristics and limitations by the department or a county employe certified as a soil tester.

3. Plans. a. Plans and specifications prepared in accord with s. ILHR 83.04 (2) (b), shall be approved by the department and the appropriate county prior to permit issuance.

b. The approval shall remain in effect for 2 years after the date of approval. Approvals may be renewed. If construction does not commence within the 2 year period and the approval is not renewed, the approval is void and the permit as related to the limitation requirements may be reissued to another individual.

4. Inspections. a. Persons responsible for inspecting alternative private sewage systems shall be certified as a plumbing inspector II or III as specified in s. ILHR 81.15, they shall have attended a training session relating specifically to mound systems and have received certification of such attendance.

b. Mound systems shall be inspected at the time the ground surface is plowed, while the sand fill is being placed, at the time the distribution piping installation has been completed and after all work has been completed. Other inspections may be necessary dependent upon site conditions or as required in this chapter.

c. A report of each inspection on forms furnished by the department shall be submitted to the department with a copy retained in the county's files.

d. The person or persons making inspections shall submit a statement on forms furnished by the department indicating whether the installation was in accord with the approved plans and specifications within 10 days after the installation work is completed. A copy shall be retained in the county's files.

(b) *Maintenance.* An alternative private sewage system shall be maintained in acceptable working condition at all times with the septic tank pumped in accord with s. ILHR 83.16. A report of servicing on forms provided by the department shall be submitted to the department and the appropriate county.

(5) MONITORING AND EVALUATION. (a) *General.* The department shall monitor and evaluate the performance of the counties, installers, soil testers and system designers during the trial program for alternative private sewage systems. The results of the evaluations by the department will be used to determine whether each alternative private sewage system will be allowed for general use after the trial program.

(b) *State monitoring.* 1. Site evaluation. Department staff shall randomly field check 10% of the sites and a minimum if possible of 5 per county per year for which plans to construct alternative private sewage systems are received by the department. Comparisons shall be made to the soil test report and the county on-site inspection.

2. Installation evaluation. Department staff shall randomly check 10%, of all alternative private sewage system installations, and a minimum if possible of 5 per county per year to determine if the system was properly constructed.

3. Continuing inspection. Department staff shall visually check as many alternative private sewage systems as possible during the 5 year control period to check for surfacing of effluent.

(c) *County monitoring.* The county shall visually inspect each alternative private sewage system within their jurisdiction a minimum of once every 2 years. The inspection shall consist of checking for surfacing of effluent around the system, ponding of effluent in the bed or trenches and to check the pump, pumping chamber and septic tank.

*History:* Cr. Register, December, 1980, No. 300, eff. 1-1-81; renum. from H 63.22, Register, June, 1983, No. 330, eff. 7-1-83.

**ILHR 83.23 Mound systems.** (1) **SOIL AND SITE REQUIREMENTS.** (a) *General.* The soil and site factors which effect the suitability of a site for the installation of a mound, on slowly permeable soils with or without high groundwater, shallow permeable soils over pervious bedrock or permeable soils with high groundwater are given in Table 14. The installation of a mound in a floodplain or filled area is prohibited. Removal of the fill material may not make the site suitable. A mound shall not be installed in a compacted area. A mound shall not be installed over a failing conventional system.

**Table 14**  
**SOIL AND SITE FACTORS THAT RESTRICT**  
**MOUND SYSTEM INSTALLATION**

Restricting Factors	Soil Group		
	Slowly Permeable Soils	Permeable Soils With Pervious Bedrock	Permeable Soils With High Groundwater
Percolation rate	Greater than 60 to 120 min/in	3 to 60 min/in	0 to 60 min/in
Depth to pervious rock	24 in.	24 in.	24 in.
Depth to high groundwater	24 in.	24 in.	24 in.
Depth to impermeable rock strata	60 in.	60 in.	60 in.
Depth to 50% by volume rock fragments	24 in.	24 in.	24 in.

(b) *Soil boring and percolation tests.* A minimum of 3 soil borings shall be conducted in accord with s. ILHR 83.09 to determine depth to seasonal or permanent soil saturation or bedrock. Identification of a replacement system area is not required.

1. Slowly permeable soils with or without high groundwater. Percolation tests shall be conducted at a depth of 20 to 24 inches from exiting grade. If a more slowly permeable horizon exists at less than 20 to 24 inches, percolation tests shall be conducted within that horizon. A mound system is suitable for this site condition if the percolation rate is greater than 60 and less than or equal to 120 minutes per inch.



2. Shallow permeable soils over creviced bedrock. Percolation tests shall be conducted at a depth of 12 to 18 inches from existing grade. If a more slowly permeable horizon exists within 12 to 18 inches, percolation tests shall be conducted within that horizon. A mound system is suitable for this site if the percolation rate is between 3 and 60 minutes per inch.

3. Permeable soils with high groundwater. Percolation tests shall be conducted at a depth of 20 to 24 inches from existing grade. If a more slowly permeable horizon exists at less than 20 to 24 inches, percolation tests shall be conducted within that horizon. A mound system is suitable for this site condition if the percolation rate is between 0 and 60 minutes per inch.

(c) *Depth to pervious rock.* There shall be at least 24 inches of unsaturated natural soil over creviced or porous bedrock.

(d) *Depth to high groundwater.* There shall be at least 24 inches of unsaturated natural soil over high groundwater as indicated by soil mottling or direct observation of water in accord with s. ILHR 83.09 (4) (d) and (e).

(e) *Slopes.* 1. Maximum allowable slopes. A mound shall not be installed on a slope which is greater than 6% if the percolation rate is between 30 and 120 minutes per inch. If the percolation rate is 0 to less than 30 minutes per inch, the maximum allowable slope is 12%.

2. Location of mound on sloping sites. The mound shall be located so that the longest dimension of the mound and the distribution lines are perpendicular to the slope. The mound shall be placed upslope and not at the base of a slope. If there is a complex slope (2 directions), the mound should be situated so that the effluent is not concentrated in one direction. Surface water runoff shall be diverted around the mound.

(f) *Depth to rock strata or 50% by volume rock fragments.* There shall be at least 60 inches of soil over uncreviced, impermeable bedrock. If the soil contains 50% coarse fragments by volume in the upper 24 inches, a mound cannot be installed unless there is at least 24 inches of permeable, unsaturated soil that has less than 50% coarse fragments beneath this layer.

(2) MOUND DIMENSIONS AND DESIGN. For residential dwellings and public buildings with estimated wastewater flows less than 600 gallons per day, the mound dimensions in Tables 17 through 28 may be used. The dimensions and corresponding letter designations listed in the tables and referred to in this section are shown in figures 1 through 5. For all buildings with estimated wastewater flows exceeding 600 gallons per day, the mound shall be designed in accord with the calculations specified in pars. (a) through (h).

(a) *Daily wastewater flow.* 1. Residential. The daily wastewater flow shall be estimated as 150 gallons per bedroom per day.

2. Public building. The total daily wastewater flow shall be determined in accord with s. ILHR 83.15 (3) (c) 2.

(b) *Design of the absorption area.* The size of the absorption area is dependent upon the infiltrative capacity of the medium sand texture fill material and the daily wastewater flow. The infiltration rate for the me-

Register, February, 1985, No. 350

dium sand shall be 1.2 gal/ft.<sup>2</sup>/day. The required absorption area shall be determined by dividing the total wastewater flow by 1.2 gal/ft.

(c) *System configuration.* 1. Trenches. a. For slowly permeable soils with or without high groundwater, the effluent shall be distributed in the mound through a trench system. Trench length should be selected by determining the longest dimension that is perpendicular to any slope on the site. Trench width and trench spacing is dependent on specific site conditions.

b. Trenches shall be 2 to 4 feet in width.

c. The lineal feet of trench required shall be calculated by dividing the required absorption area by the trench width (A). Trench length (B) shall not be more than 100 feet. Where more than one trench is required, the trenches should be of equal length. A mound should not have more than 3 trenches.

d. Trench spacing (C) shall be determined by comparing the estimated wastewater flow, the infiltrative capacity of the natural soil and the trench length (B). Trench spacing (C) shall be calculated as:

Trench spacing

$$(C) = \frac{\text{Estimated wastewater flow}}{\text{Number of trenches}} \div (0.24 \text{ gal/ft.}^2/\text{day}) \div \text{trench length (B)}.$$

The calculated trench spacing (C) shall be measured from center to center of the trenches.

Note: For facilities with more than 1,500 gallons per day that must use a trench system, the department should be contacted prior to system design.

2. Beds. A long, narrow bed design should be used for permeable soils with high water tables. The bed can be square or rectangular for shallow permeable soils over bedrock. The bed length (B) should be set after determining the longest dimension that is available and that is perpendicular to any slope on the site. The bed width (A) shall be determined by dividing the absorption area required by (B).

(d) *Mound dimensions.* 1. Mound height. The mound height consists of the fill depth, the bed or trench depth, the cap and top soil depth.

a. The fill depth (D) shall be at least 1 foot for slowly permeable soils and for permeable soils with high water tables. For shallow permeable soils over bedrock, a minimum of 2 feet of fill is required. If the site is not level, additional fill shall be placed at the downslope end of the bed or trench so that the bottom of the bed or the trenches are level. For bed systems the downslope fill depth (E) = D + (Percentage) (A). For trench systems the downslope fill depth (E) = D + (slope) (C + A).

b. The bed or trench depth (F) shall be at least .75 feet. At least 6 inches of aggregate shall be placed under the distribution pipes and at least 2 inches of aggregate shall be placed over the top of the distribution pipes.

c. The cap and top soil depth (H) at the center of the mound shall be at least 1.5 feet which includes 1 foot of subsoil and 0.5 feet of top soil. At the outer edges of the mound the minimum cap and top soil depth (G) shall be 1 foot which includes 0.5 feet of subsoil and 0.5 feet of top soil. The soil used for the cap can be top soil or finer textured subsoil.

2. Mound length. The total mound length (L) is equal to the bed or trench length plus the end slopes (K).

a. The end slope (K) =  
 mound depth at center x 3:1 slope =  

$$\frac{[(D + E) + F + H]3}{2}$$

b. The total mound length (L) =  
 (bed or trench length, B) + 2 (end slope, K).

3. Mound width. The total width (W) of a mound with a bed design shall be equal to the upslope width (J), the bed width (A) and the downslope width (I). When a trench design is used, the total width (W) shall be equal to the upslope width (J), the trench width or widths (A), the trench spacing (C) and the downslope width (I). On sloping sites the downslope width (I) shall be greater than the upslope width (J). On level sites the upslope width and the downslope width shall be the same.

a. Upslope width (J) = mound depth at upslope edge x 3:1 slope x  
 slope correction factor from Table 15 =  

$$(D + F + G) \times 3 \times \text{correction factor}$$

b. Downslope width (I) = mound depth at downslope edge x 3:1  
 slope x slope correction factor from  
 Table 15 =  

$$(E + F + G) \times 3 \times \text{correction factor}$$

c. The mound width (W) for a bed system =  
 upslope width (J) + bed width (A) + downslope width (I).

The mound width (W) for a trench system =  
 upslope width (J) +  $\frac{\text{trench width (A)}}{2}$  + [(number trenches - 1) x  
 (trench spacing (C))] +  $\frac{\text{trench width (A)}}{2}$  + downslope width (I).

Table 15  
 DOWNSLOPE AND UPSLOPE WIDTH CORRECTIONS FOR MOUNDS  
 ON SLOPING SITES

Slope %	Downslope Correction Factor	Upslope Correction Factor
0	1.0	1.0
1	1.03	.97
2	1.06	.94
3	1.10	.915
4	1.14	.89
5	1.18	.875
6	1.22	.86
7	1.27	.83
8	1.32	.80
9	1.38	.785
10	1.44	.77
11	1.51	.75
12	1.57	.73

(e) *Basal area.* 1. Minimum basal area required. The minimum basal area required is dependent upon the infiltrative capacity of the natural soil. The infiltrative capacities listed in Table 16 are determined by the percolation rate of the soil. To calculate the minimum required basal area, divide the total daily flow by the appropriate infiltrative capacity of the natural soil.

Table 16

Percolation Rate	Infiltrative Capacity of the Natural Soil
0 to less than 30 min./in.	1.2 gal./ft/day
30 to 60 min./in.	.74 gal./ft/day
greater than 60 to 120 min./in.	.24 gal./ft/day

2. Basal area available, bed. On sloping sites the basal area shall be that area under the bed and downslope of the bed. On level sites the basal area shall be the entire area under the mound excluding the end slope areas. The appropriate equation from one of the following shall be used to determine the available basal area.

Bed length (B) x (bed width (A) + downslope width (I) = basal area available for sloping site

Bed length (B) x total mound width (W) = basal area available for level sites

3. Basal area available, trench. On sloping sites the basal area shall be that area under and downslope of the trenches. On level sites the basal area shall be the total area under the mound excluding the end slope areas. The appropriate equation from one of the following shall be used to determine the available basal area.

Trench length (B) x [mound width (W) - upslope width (J) +  $\frac{\text{trench width (A)}}{2}$ ] =  
basal area available for sloping sites

Trench length (B) x total mound width (W) = basal area available for level sites

4. Adequacy of basal area. If the basal area available is not equal to or greater than the basal area required, the downslope width (I) on a sloping site shall be increased or the up and downslope widths (J) and (I) on a level site shall be increased until sufficient area is available.

(f) *Distribution system.* The distribution system for mounds for daily flows less than 600 gallons per day may be sized in accord with the applicable criteria in sub. (3) or with s. ILHR 83.14 (3). For all other buildings, the distribution system shall be designed in accord with s. ILHR 83.14 (3).

(g) *Pump selection.* Pump selection shall be based upon the criteria specified in s. ILHR 83.14 (5). See s. ILHR 83.14 (6) for pump and alarm controls and s. ILHR 83.15 (5) (b) for dosing chamber capacity and all other applicable requirements.

(h) *Dose volume.* The dose volume for daily flows less than 600 gallons per day may be sized in accord with the applicable criteria in s. ILHR 83.14 (6). The dose volume for systems in excess of 600 gallons per day shall be sized in accord with ss. ILHR 83.14 and 83.15 (3) (c) 2.

(3) DESIGN CRITERIA FOR 3 SITE CONDITIONS FOR TOTAL DAILY WASTEWATER FLOWS WHICH ARE LESS THAN OR EQUAL TO 600 GALLONS. The following tables and diagrams may be used for sizing and designing mounds for one and 2 family residences.

Table 17

DESIGN CRITERIA FOR A MOUND FOR A 1 BEDROOM HOME  
ON 0 TO 6% SLOPE WITH LOADING RATES UP TO 150 GAL/DAY  
FOR SLOWLY PERMEABLE SOIL

PARAMETER	SYMBOL	UNITS	SLOPE %			
			0	2	4	6
Trench Width	A	Ft	3	3	3	3
Trench Length	B	Ft	42	42	42	42
No. of Trenches	—	—	1	1	1	1
Mound Height	D	Ft	1	1	1	1
	F	Ft	0.75	0.75	0.75	0.75
	G	Ft	1	1	1	1
	H	Ft	1.5	1.5	1.5	1.5
Mound Width	J	Ft	11 *	8	8	8
	I *	Ft	11	15	15	15
	W	Ft	25	26	26	26
Mound Length	K	Ft	10	10	10	10
	L	Ft	62	62	62	62
Dist. Pipe Length	P	Ft	20	20	20	20
Dist. Pipe Diameter	—	In	1	1	1	1
No. of Holes per						
Dist. Pipe**	—	—	9	9	9	9
Hole Spacing*	—	In	30	30	30	30
Hole Diameter**	—	In	1/4	1/4	1/4	1/4

\* Additional width to obtain required basal area

\*\* Last hole is located at end of dist. pipe which is 15" from other hole

Table 18

DESIGN CRITERIA FOR A MOUND FOR A 2 BEDROOM HOME  
ON 0 to 6% SLOPE WITH LOADING RATES TO 300 GAL/DAY  
FOR SLOWLY PERMEABLE SOIL

PARAMETER	SYMBOL	UNITS	SLOPE %			
			0	2	4	6
Trench Width	A	Ft	3	3	3	3
Trench Length	B	Ft	42	42	42	42
No. of Trenches	—	—	2	2	2	2
Trench Spacing	C	Ft	15	15	15	15
Mound Height	D	Ft	1	1	1	1
	E	Ft	1	1.4	1.7	2.1
	F	Ft	0.75	0.75	0.75	0.75
	G	Ft	1	1	1	1
	H	Ft	1.5	1.5	1.5	1.5
Mound Width	J	Ft	12	8	8	8
	I *	Ft	12	20	20	20
	W	Ft	42	46	46	46
Mound Length	K	Ft	10	10	10	10
	L	Ft	62	62	62	62
Dist. Pipe Length	P	Ft	20	20	20	20
Dist. Pipe Diameter	—	In	1	1	1	1
No. of Holes per Dist. Pipe**	—	—	9	9	9	9
Hole Spacing**	—	In	30	30	30	30
Hole Diameter	—	In	1/4	1/4	1/4	1/4
Manifold Length	R	Ft	15	15	15	15
Manifold Diameter***	—	In	2	2	2	2

\* Additional width to obtain required basal area

\*\* Last hole is located at end of dist. pipe which is 15" from other hole

\*\*\* Diameter dependent upon size of pipe from pump and inlet position

**Table 19**

**DESIGN CRITERIA FOR A MOUND FOR A 3 BEDROOM HOME  
ON A 0 to 6% SLOPE WITH LOADING RATES OF 450 GAL/DAY  
FOR SLOWLY PERMEABLE SOILS**

PARAMETER	SYMBOL	UNITS	SLOPE %			
			0	2	4	6
Trench Width	A	Ft	3	3	3	3
Trench Length	B	Ft	63	63	63	63
No. of Trenches	—	—	2	2	2	2
Trench Spacing	C	Ft	15	15	15	15
Mound Height	D	Ft	1	1	1	1
	E	Ft	1	1.4	1.7	2.1
	F	Ft	0.75	0.75	0.75	0.75
	G	Ft	1	1	1	1
	H	Ft	1.5	1.5	1.5	1.5
Mound Width	J	Ft	12 *	8	8	8
	I*	Ft	12	20	20	20
	W	Ft	42	46	46	46
Mound Length	K	Ft	10	10	10	10
	L	Ft	83	83	83	83
Dist. Pipe Length	P	Ft	31	31	31	31
Dist. Pipe Diameter	—	In	1-1/4	1-1/4	1-1/4	1-1/4
No. of Holes per Dist. Pipe**	—	—	13	13	13	15
Hole Spacing*	—	In	30	30	30	30
Hole Diameter	—	In	1/4	1/4	1/4	1/4
Manifold Length	R	Ft	15	15	15	15
Manifold Diameter***	—	In	2	2	2	2

\* Additional width to obtain required basal area

\*\* First hole is located 12" from the manifold

\*\*\* Diameter dependent upon size of pipe from pump and inlet position



Table 20

DESIGN CRITERIA FOR A MOUND FOR A 4 BEDROOM HOME  
ON A 0 to 6% SLOPE WITH LOADING RATES OF 600 GAL/DAY  
FOR SLOWLY PERMEABLE SOILS

PARAMETER	SYMBOL	UNITS	SLOPE %			
			0	2	4	6
Trench Width	A	Ft	3	3	3	3
Trench Length	B	Ft	56	56	56	56
No. of Trenches	—	—	3	3	3	3
Trench Spacing	C	Ft	15	15	15	15
Mound Height	D	Ft	1	1	1	1
	E	Ft	1	1.7	2.3	3.0
	F	Ft	0.75	0.75	0.75	0.75
	G	Ft	1	1	1	1
Mound Width	H	Ft	1.5	1.5	1.5	1.5
	J	Ft	12*	8	8	8
	I*	Ft	12	20	20	20
Mound Length	W	Ft	57	61	61	61
	K	Ft	12	12	12	14
Mound Length	L	Ft	80	80	80	84
	P	Ft	27.5	27.5	27.5	27.5
Dist. Pipe Length	—	In	1-1/4	1-1/4	1-1/4	1-1/4
No. of Holes per Dist. Pipe**	—	—	12	12	12	12
Hole Spacing**	—	In	30	30	30	30
Hole Diameter	—	In	1/4	1/4	1/4	1/4
Manifold Length	R	Ft	30	30	30	30
Manifold Diameter***	—	In	2	2	2	2

\* Additional width to obtain required basal area

\*\* Last hole is located at end of dist. pipe which is 15" from previous hole

\*\*\* Diameter dependent upon size of pipe from pump and inlet position

Table 21

DESIGN CRITERIA FOR A 1 BEDROOM HOME FOR A MOUND ON  
0 TO 12% SLOPE WITH LOADING RATES UP TO 150 GAL/DAY  
FOR SHALLOW PERMEABLE SOIL OVER CREVICED BEDROCK

PARAMETER	SYMBOL	UNITS	PERCOLATION RATE MIN/IN							
			3 to 60				3 to less than 30			
Slope	—	%	0	2	4	6	8	10 <sup>2</sup>	12 <sup>2</sup>	
Bed Width	A <sup>4</sup>	Ft	10	10	10	10	10	10	10	
Bed Length	B	Ft	13	13	13	13	13	13	13	
Mound Height	D	Ft	2	2	2	2	2	2	2	
	E	Ft	2	2.2	2.4	2.6	2.8	3.0	3.2	
	F	Ft	.75	.75	.75	.75	.75	.75	.75	
	G	Ft	1	1	1	1	1	1	1	
Mound Width	H	Ft	1.5	1.5	1.5	1.5	1.5	1.5	1.5	
	J	Ft	12	11	10	10	9	9	9	
	I	Ft	12	13	14	17	18	21	26	
	W	Ft	34	34	34	37	37	41	45	
Mound Length	K	Ft	12	12	12	13	13	13	15	
	L	Ft	37	37	37	39	39	39	43	
Dist. Pipe Length	P <sup>3</sup>	Ft	12.5	12.5	12.5	12.5	12.5	12.5	12.5	
Dist. Pipe Diameter	—	In	1	1	1	1	1	1	1	
No. of Dist. Pipes	—	—	6	6	6	6	6	6	6	
Dist. Pipe Spacing	S	Ft	3	3	3	3	3	3	3	
No. of Holes per Dist. Pipe <sup>1</sup>	—	Ft	6	6	6	6	6	6	6	
Hole Spacing <sup>1</sup>	—	In	30	30	30	30	30	30	30	
Hole Diameter	—	In	1/4	1/4	1/4	1/4	1/4	1/4	1/4	
Manifold Length	R	Ft	6	6	6	6	6	6	6	
Manifold Diameter	—	In	2	2	2	2	2	2	2	

- 1 Last hole is located at end of dist. pipe which is 15" from previous hole.
- 2 On sites with 10-12% slope, the fill depth D may be reduced to 1.5 ft or the bed width may be reduced so E isn't so great.
- 3 Use a manifold with dist. pipes only on one side.
- 4 Beds can be any desired width.

Table 22

DESIGN CRITERIA FOR A 2 BEDROOM HOME FOR A MOUND ON  
0 TO 12% SLOPE WITH LOADING RATES UP TO 300 GAL/DAY  
FOR SHALLOW PERMEABLE SOIL OVER CREVICED BEDROCK

PARAMETER	SYMBOL	UNITS	PERCOLATION RATE MIN/IN							
			3 to 60				3 to less than 30			
Slope	---	%	0	2	4	6	8	10 <sup>2</sup>	12 <sup>2</sup>	
Bed Width	A <sup>4</sup>	Ft	10	10	10	10	10	10	10	
Bed Length	B	Ft	25	25	25	25	25	25	25	
Mound Height	D	Ft	2	2	2	2	2	2	2	
	E	Ft	2	2.2	2.4	2.6	2.8	3.0	3.2	
	F	Ft	.75	.75	.75	.75	.75	.75	.75	
	G	Ft	1	1	1	1	1	1	1	
	H	Ft	1.5	1.5	1.5	1.5	1.5	1.5	1.5	
Mound Width	J	Ft	12	11	10	10	9	9	9	
	I	Ft	12	13	14	17	18	21	26	
	W	Ft	34	34	34	37	37	41	45	
Mound Length	K	Ft	12	12	12	13	13	13	15	
	L	Ft	49	49	49	51	51	51	55	
Dist. Pipe Length	P <sup>3</sup>	Ft	12	12	12	12	12	12	12	
Dist. Pipe Diameter	---	In	1	1	1	1	1	1	1	
No. of Dist. Pipes	---	---	6	6	6	6	6	6	6	
Dist. Pipe Spacing	S	Ft	3	3	3	3	3	3	3	
No. of Holes per Dist. Pipe <sup>1</sup>	---	---	5	5	5	5	5	5	5	
Hole Spacing <sup>1</sup>	---	In	30	30	30	30	30	30	30	
Hole Diameter	---	In	1/4	1/4	1/4	1/4	1/4	1/4	1/4	
Manifold Length	R	Ft	6	6	6	6	6	6	6	
Manifold Diameter	---	In	2	2	2	2	2	2	2	

1 Last hole is located 9" from end of dist. pipe.

2 On sites with 10-12% slope, the fill depth D may be reduced to 1.5 ft or the bed width may be reduced so E isn't so great.

3 This design is based on a manifold with dist. pipes on both sides. It could be designed using 24 ft. dist. pipes with manifold at end.

4 Beds can be any desired width.

Table 23

DESIGN CRITERIA FOR A 3 BEDROOM HOME FOR A MOUND ON  
 0 TO 12% SLOPE WITH LOADING RATES UP TO 450 GAL/DAY  
 FOR SHALLOW PERMEABLE SOIL OVER CREVICED BEDROCK

PARAMETER	SYMBOL	UNITS	PERCOLATION RATE MIN/IN							
			3 to 60				3 to less than 30			
Slope	—	%	0	2	4	6	8	10 <sup>2</sup>	12 <sup>2</sup>	
Bed Width	A <sup>4</sup>	Ft	10	10	10	10	10	10	10	
Bed Length	B	Ft	38	38	38	38	38	38	38	
Mound Height	D	Ft	2	2	2	2	2	2	2	
	E	Ft	2	2.2	2.4	2.6	2.8	3.0	3.2	
	F	Ft	.75	.75	.75	.75	.75	.75	.75	
	G	Ft	1	1	1	1	1	1	1	
	H	Ft	1.5	1.5	1.5	1.5	1.5	1.5	1.5	
Mound Width	J	Ft	12	11	10	10	9	9	9	
	I	Ft	12	13	14	17	18	21	26	
	W	Ft	34	34	34	37	37	41	45	
Mound Length	K	Ft	12	12	12	13	13	13	15	
	L	Ft	62	62	62	64	64	64	68	
Dist. Pipe Length	P <sup>3</sup>	Ft	18.5	18.5	18.5	18.5	18.5	18.5	18.5	
Dist. Pipe Diameter	—	In	1	1	1	1	1	1	1	
No. of Dist. Pipes	—	—	6	6	6	6	6	6	6	
Dist. Pipe Spacing	S	Ft	3	3	3	3	3	3	3	
No. of Holes per Dist. Pipe <sup>1</sup>	—	—	8	8	8	8	8	8	8	
Hole Spacing <sup>1</sup>	—	In	30	30	30	30	30	30	30	
Hole Diameter	—	In	¼	¼	¼	¼	¼	¼	¼	
Manifold Length	R	Ft	6	6	6	6	6	6	6	
Manifold Diameter	—	In	2	2	2	2	2	2	2	

1 Last hole is located at end of dist. pipe which is 27" from previous hole.

2 On sites with 10-12% slope, the fill depth D may be reduced to 1.5 ft or the bed width may be reduced so E isn't so great.

3 Use a manifold with dist. pipes only on one side.

4 Beds can be any desired width.

Table 24

DESIGN CRITERIA FOR A 4 BEDROOM HOME FOR A MOUND ON  
0 TO 12% SLOPE WITH LOADING RATES UP TO 600 GAL/DAY  
FOR SHALLOW PERMEABLE SOIL OVER CREVICED BEDROCK

PARAMETER	SYMBOL	UNITS	PERCOLATION RATE MIN/IN							
			3 to 60				3 to less than 30			
Slope	—	%	0	2	4	6	8	10 <sup>2</sup>	12 <sup>2</sup>	
Bed Width	A <sup>4</sup>	Ft	10	10	10	10	10	10	10	
Bed Length	B	Ft	50	50	50	50	50	50	50	
Mound Height	D	Ft	2	2	2	2	2	2	2	
	E	Ft	2	2.2	2.4	2.6	2.8	3.0	3.2	
	F	Ft	.75	.75	.75	.75	.75	.75	.75	
	G	Ft	1	1	1	1	1	1	1	
	H	Ft	1.5	1.5	1.5	1.5	1.5	1.5	1.5	
Mound Width	J	Ft	12	11	10	10	9	9	9	
	I	Ft	12	13	14	17	18	21	26	
	W	Ft	34	34	34	37	37	41	45	
Mound Length	K	Ft	12	12	12	13	13	13	15	
	L	Ft	74	74	74	76	76	76	78	
Dist. Pipe Length	p <sup>3</sup>	Ft	24.5	24.5	24.5	24.5	24.5	24.5	24.5	
Dist. Pipe Diameter	—	In	1	1	1	1	1	1	1	
No. of Dist. Pipes	—	—	6	6	6	6	6	6	6	
Dist. Pipe Spacing	S	Ft	3	3	3	3	3	3	3	
No. of Holes per Dist. Pipe <sup>1</sup>	—	—	10	10	10	10	10	10	10	
Hole Spacing <sup>1</sup>	—	In	30	30	30	30	30	30	30	
Hole Diameter	—	In	¼	¼	¼	¼	¼	¼	¼	
Manifold Length	R	Ft	6	6	6	6	6	6	6	
Manifold Diameter	—	In	2	2	2	2	2	2	2	

1 Last hole is located 9" from end of dist. pipe.

2 On sites with 10-12% slope, the fill depth D may be reduced to 1.5 ft or the bed width may be reduced so E isn't so great.

3 Use a manifold with dist. pipes only on one side.

4 Beds can be any desired width.

Table 25

DESIGN CRITERIA FOR A MOUND FOR A 1 BEDROOM HOME ON  
0-12% SLOPE FOR LOADING RATES OF 150 GAL/DAY  
FOR PERMEABLE SOIL WITH HIGH WATER TABLE

PARAMETER	SYMBOL	UNITS	PERCOLATION RATE MIN/IN							
			0 to 60				0 to less than 30			
Slope	—	%	0	2	4	6	8	10	12	
Bed Width	A	Ft	4	4	4	4	4	4	4	
Bed Length	B	Ft	32	32	32	32	32	32	32	
Mound Height	D	Ft	1	1	1	1	1	1	1	
	E	Ft	1	1.1	1.2	1.2	1.3	1.4	1.5	
	F	Ft	.75	.75	.75	.75	.75	.75	.75	
	G	Ft	1	1	1	1	1	1	1	
Mound Width	H	Ft	1.5	1.5	1.5	1.5	1.5	1.5	1.5	
	J	Ft	9	9	8	8	7	7	6	
	I	Ft	9	10	11	12	13	14	15	
Mound Length	W	Ft	22	23	23	24	24	25	25	
	K	Ft	10	10	10	10	10	11	11	
Dist. Pipe Length	L	Ft	52	52	52	52	52	53	53	
	P	Ft	15.5	15.5	15.5	15.5	15.5	15.5	15.5	
Dist. Pipe Diameter	—	In	1	1	1	1	1	1	1	
No. of Dist. Pipes	—	—	2	2	2	2	2	2	2	
No. of Holes per Dist. Pipe*	—	—	7	7	7	7	7	7	7	
Hole Spacing*	—	In	30	30	30	30	30	30	30	
Hole Diameter	—	In	1/4	1/4	1/4	1/4	1/4	1/4	1/4	

\* Last hole is located at end of dist. pipe which is 21" from previous hole.

Table 26

DESIGN CRITERIA FOR A MOUND FOR A 2 BEDROOM HOME ON  
0-12% SLOPE FOR LOADING RATES OF 300 GAL/DAY  
FOR PERMEABLE SOIL WITH HIGH WATER TABLE

PARAMETER	SYMBOL	UNITS	PERCOLATION RATE MIN/IN							
			0 to 60				0 to less than 30			
Slope	—	%	0	2	4	6	8	10	12	
Bed Width	A	Ft	6	6	6	6	6	6	6	
Bed Length	B	Ft	42	42	42	42	42	42	42	
Mound Height	D	Ft	1	1	1	1	1	1	1	
	E	Ft	1	1.1	1.2	1.4	1.5	1.6	1.8	
	F	Ft	.75	.75	.75	.75	.75	.75	.75	
	G	Ft	1	1	1	1	1	1	1	
	H	Ft	1.5	1.5	1.5	1.5	1.5	1.5	1.5	
Mound Width	J	Ft	9	9	8	8	7	7	6	
	I	Ft	9	10	11	12	13	15	17	
	W	Ft	24	25	25	26	26	28	29	
Mound Length	K	Ft	10	10	10	10	10	11	11	
	L	Ft	62	62	62	62	62	64	64	
Dist. Pipe Length	P	Ft	20	20	20	20	20	20	20	
Dist. Pipe Diameter	—	In	1	1	1	1	1	1	1	
No. of Dist. Pipes	—	—	4	4	4	4	4	4	4	
Dist. Pipe Spacing	S	Ft	3	3	3	3	3	3	3	
No. of Holes per Dist. Pipe *	—	Ft	9	9	9	9	9	9	9	
	—	In	30	30	30	30	30	30	30	
Hole Spacing *	—	In	1/4	1/4	1/4	1/4	1/4	1/4	1/4	
Hole Diameter	—	In	1/4	1/4	1/4	1/4	1/4	1/4	1/4	
Manifold Length	R	Ft	3	3	3	3	3	3	3	
Manifold Diameter	—	In	2	2	2	2	2	2	2	

\* Last hole is located at end of dist. pipe which is 15" from previous hole.

Table 27

DESIGN CRITERIA FOR A MOUND FOR A 3 BEDROOM HOME ON  
 0-12% SLOPE FOR LOADING RATE OF 450 GAL/DAY  
 FOR PERMEABLE SOIL WITH HIGH WATER TABLE

PARAMETER	SYMBOL	UNITS	PERCOLATION RATE MIN/IN							
			0 to 60				0 to less than 30			
Slope	—	%	0	2	4	6	8	10	12	
Bed Width	A	Ft	8	8	8	8	8	8	8	
Bed Length	B	Ft	47	47	47	47	47	47	47	
Mound Height	D	Ft	1	1	1	1	1	1	1	
	E	Ft	1	1.2	1.3	1.5	1.6	1.8	2.0	
	F	Ft	.75	.75	.75	.75	.75	.75	.75	
	G	Ft	1	1	1	1	1	1	1	
	H	Ft	1.5	1.5	1.5	1.5	1.5	1.5	1.5	
Mound Width	J	Ft	9	9	8	8	7	7	6	
	I	Ft	9	11	12	13	15	17	18	
	W	Ft	26	28	28	29	30	32	32	
Mound Length	K	Ft	10	10	10	10	11	11	12	
	L	Ft	67	67	67	67	69	69	71	
Dist. Pipe Length	P	Ft	23	23	23	23	23	23	23	
Dist. Pipe Diameter	—	In	1	1	1	1	1	1	1	
No. of Dist. Pipes	—	—	6	6	6	6	6	6	6	
Dist. Pipe Spacing	S	In	32	32	32	32	32	32	32	
No. of Holes per Dist. Pipe*	—	—	10	10	10	10	10	10	10	
Hole Spacing*	—	In	30	30	30	30	30	30	30	
Hole Diameter	—	In	1/4	1/4	1/4	1/4	1/4	1/4	1/4	
Manifold Length	R	Ft	64	64	64	64	64	64	64	
Manifold Diameter	—	In	2	2	2	2	2	2	2	

\* Last hole is located at end of dist. pipe which is 21" from previous hole.

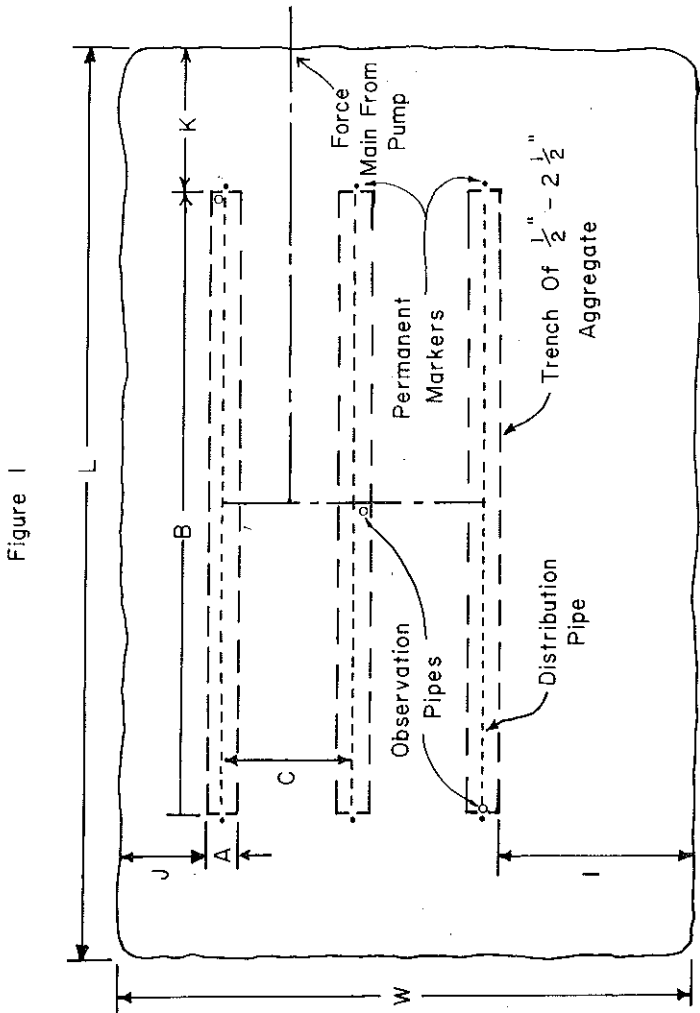

Table 28

DESIGN CRITERIA FOR A MOUND FOR A 4 BEDROOM HOME ON  
0-12% SLOPE FOR LOADING RATE OF 600 GAL/DAY  
FOR PERMEABLE SOIL WITH HIGH WATER TABLE

PARAMETER	SYMBOL	UNITS	PERCOLATION RATE MIN/IN							
			0 to 60				0 to less than 30			
Slope	---	%	0	2	4	6	8	10	12	
Bed Width	A	Ft	10	10	10	10	10	10	10	
Bed Length	B	Ft	50	50	50	50	50	50	50	
Mound Height	D	Ft	1	1	1	1	1	1	1	
	E	Ft	1	1.2	1.4	1.6	1.8	2	2.2	
	F	Ft	.75	.75	.75	.75	.75	.75	.75	
	G	Ft	1	1	1	1	1	1	1	
	H	Ft	1.5	1.5	1.5	1.5	1.5	1.5	1.5	
Mound Width	J	Ft	9	8	8	8	7	7	6	
	I	Ft	9	11	13	14	17	18	19	
	W	Ft	28	29	31	32	34	35	35	
Mound Length	K	Ft	10	10	10	10	11	11	12	
	L	Ft	70	70	70	70	72	72	74	
Dist. Pipe Length	P	Ft	24.5	24.5	24.5	24.5	24.5	24.5	24.5	
Dist. Pipe Diameter	—	In	1	1	1	1	1	1	1	
No. of Dist. Pipes	—	—	6	6	6	6	6	6	6	
Dist. Pipe Spacing	S	Ft	3	3	3	3	3	3	3	
No. of Holes per Dist. Pipe*	—	—	10	10	10	10	10	10	10	
Hole Spacing*	—	In	30	30	30	30	30	30	30	
Hole Diameter	—	In	1/4	1/4	1/4	1/4	1/4	1/4	1/4	
Manifold Length	R	Ft	6	6	6	6	6	6	6	
Manifold Diameter	—	In	2	2	2	2	2	2	2	

\* Last hole is 9" from end of dist. pipe.



Mound Using 3 Trenches For Absorption Area

Figure 2

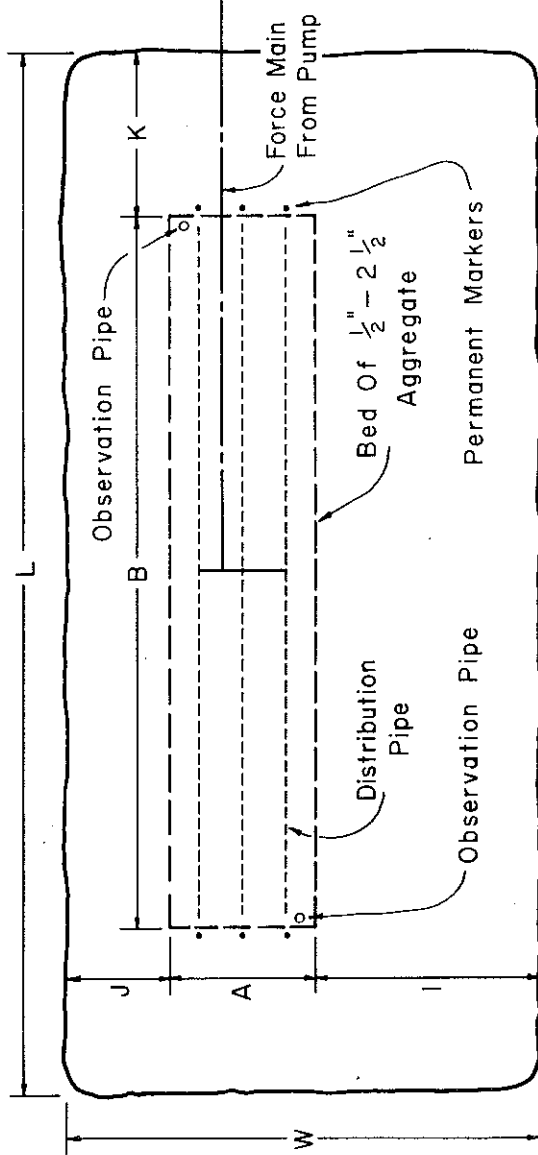

Plan View Of Mound Using A Bed For The Absorption Area

Figure 3

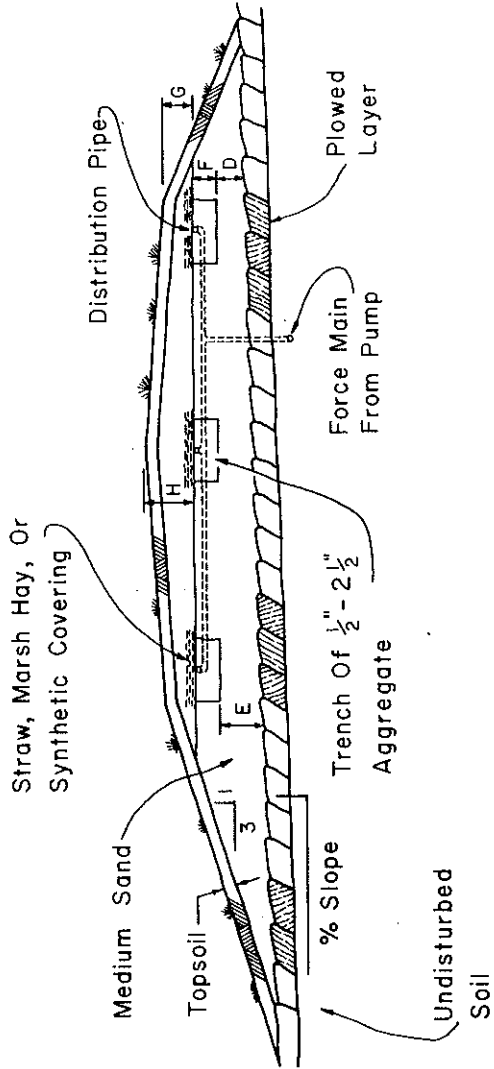

Cross Section Of A Mound System Using  
3 Trenches For The Absorption Area

Figure 4

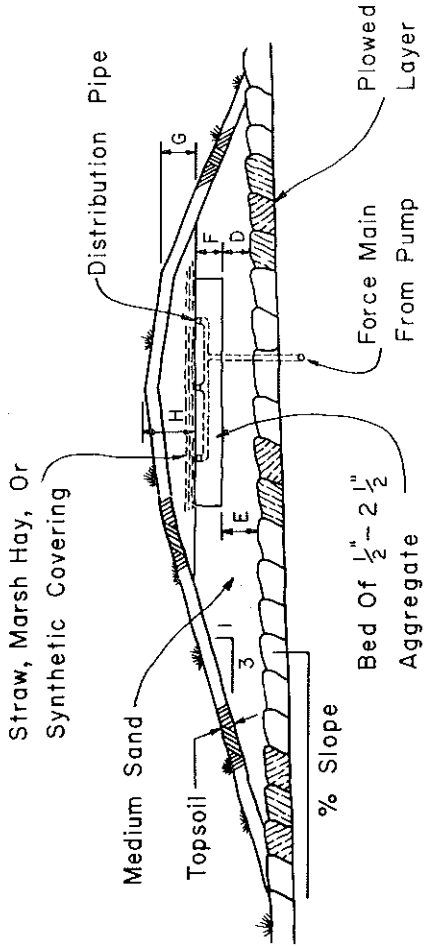

Cross Section Of A Mound System Using A Bed For The Absorption Area

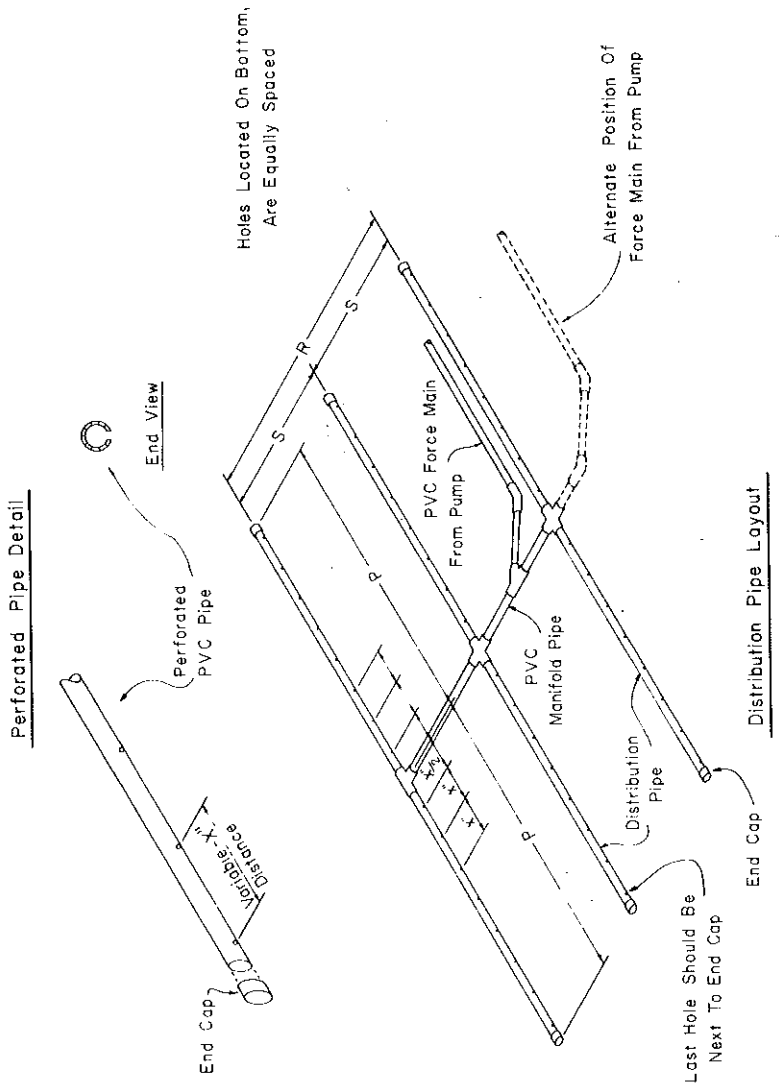

(4) **CONSTRUCTION TECHNIQUES.** Construction shall not commence if the soil is too wet. The soil is too wet for construction if at any level to a depth of 8 inches a soil wire can be formed by rolling the soil between the hands. Installation of mound systems when the soil on the site is frozen is prohibited for new construction.

(a) *Site preparation.* 1. Excess vegetation. Excess vegetation shall be cut and removed from the area of the mound. Small trees shall be cut to grade surface leaving the stumps in place.

2. Force main. The force main from the pumping chamber shall be installed before the mound site is plowed. The force main should be sloped uniformly towards the pumping chamber so that it drains after each dose.

3. Plowing. The site shall be plowed with a mold board plow or chisel plow. The site shall be plowed to a depth of 7 to 8 inches with the plowing perpendicular to the slope. Rototillers shall not be used. The sand fill shall be placed immediately after plowing. After plowing, all foot and vehicular traffic shall be kept off the plowed area.

(b) *Sand fill material.* 1. Fill quality. The fill material shall be medium sand texture which is defined as 25% or more very coarse, coarse and medium sand and less than 50% fine and very fine sand. The percentage of soil plus 1½ times the percentage of clay shall not exceed 15%. Fill materials with higher contents of silt and clay shall not be used.

2. Placement of sand fill. The medium sand fill shall be moved into place from the upslope and side edges of the plowed area. Vehicular traffic is prohibited in the area extending to 25 feet beyond the downslope edge of the mound. The sand fill shall be moved into place with a track-type tractor. A minimum of 6 inches of sand shall be kept beneath the tracks at all times.

3. Installation of the absorption area. Form the bed or trenches within the sand fill. The bottom of the trenches or bed shall be level. The elevation of the bottom of the trenches or bed shall be checked at the upslope and downslope edges to make certain that the fill has been placed to the proper depth.

4. Placement of the aggregate. A minimum of 6 inches of coarse aggregate ranging in size from ½ inch to 2½ inches shall be placed in the bed or trench excavation. The top of the aggregate shall be level.

5. Distribution system. Place the distribution system on the aggregate with the holes on the bottom of the distribution lines.

6. Cover. The top of the bed or trenches shall be covered with a minimum of 2 inches of aggregate ranging in size from ½ inch to 2½ inches. A minimum of 4 to 5 inches of uncompacted straw or marsh hay, or synthetic fabric approved by the department shall be placed over the aggregate. The cap and top soil cover shall be placed. The mound shall be seeded immediately and protected from erosion.

7. Maintenance. Maintenance shall be performed in accord with s. ILHR 83.16 (1). When the septic tank is pumped the pump chamber Register, February, 1985, No. 350

shall be inspected and shall be pumped to remove any solids if present.  
Excess traffic in the mound area shall be avoided.

History: Cr. Register, December, 1980, No. 300, eff. 1-1-81; renum. from H 63.23, Register, June, 1983, No. 330, eff. 7-1-83.

ILHR 83.24 Severability. History: Cr. Register, December, 1980, No. 300, eff. 1-1-81; renum. from H 63.24, Register, June, 1983, No. 330, eff. 7-1-83; r. under s. 13.93 (am) (b) 16, Stats., Register, February, 1985, No. 350, eff. 3-1-85.



**APPENDIX**

**CHAPTER ILHR 83  
WIS. ADM. CODE**

**FORMS USED BY THE DEPARTMENT  
IN ADMINISTRATION OF THIS  
ADMINISTRATIVE CODE**

**INSTRUCTIONS AND EXAMPLE OF  
SIZING PRESSURE DISTRIBUTION SYSTEMS**

# INDUSTRY, LABOR AND HUMAN RELATIONS 341

## ILHR 83 Appendix

DEPARTMENT OF  
INDUSTRY,  
LABOR AND  
HUMAN RELATIONS

### REPORT ON SOIL BORINGS AND PERCOLATION TESTS (115)

(H63.09(1) & Chapter 145.045)

SAFETY & BUILDINGS  
DIVISION  
P. O. BOX 7969  
MADISON, WI 53707

LOCATION COUNTY	SECTION 1/4 1/4	TOWNSHIP /T	MUNICIPALITY N/R	E(→)W	TOWNSHIP/MUNICIPALITY	LOT NO.	BLK. NO.	SUBDIVISION NAME
OWNER'S/BUYER'S NAME			MAILING ADDRESS					

USE <input type="checkbox"/> Residence	NO. BEDRCK	COMMERCIAL DESCRIPTION <input type="checkbox"/> New <input type="checkbox"/> Replace	DATES OBSERVATIONS MADE PROFILE DESCRIPTIONS PERCOLATION TESTS
---	------------	---	---

RATINGS: S= Site suitable for system U= Site unsuitable for system

CONVENTIONAL FOUND	IN-GROUND PRESSURE SYSTEM IS FTL	HOLDING TANK	RECOMMENDED SYSTEM
<input type="checkbox"/> S <input type="checkbox"/> U	<input type="checkbox"/> S <input type="checkbox"/> U	<input type="checkbox"/> S <input type="checkbox"/> U	<input type="checkbox"/> S <input type="checkbox"/> U

If Percolation Tests are NOT required under s. H63.09(1)(b), indicate:	DESIGN RATE	If any portion of the test area is on the Floodplain, indicate Floodplain No. 12345
--	-------------	---

#### PROFILE DESCRIPTIONS

BORING NUMBER	TOTAL DEPTH (ft)	ELEVATION	DEPTH TO GROUNDWATER IN INCHES		CHARACTER OF SOIL WITH THICKNESS COLUMN TEXTURE, AND DEPTH TO BEDROCK IF OBSERVED (SEE ABBY. IN BACK)
			DRYEST	EST. HIGHEST	
B-					
B-					
B-					
B-					
B-					
B-					

#### PERCOLATION TESTS

TEST NUMBER	DEPTH (INCHES)	WATER IN HOLE AFTER SWELLING	TEST TIME INTERVAL MIN.	DROP IN WATER LEVEL INCHES			DATE MADE PERIOD
				PERIOD 1	PERIOD 2	PERIOD 3	
P-							
P-							
P-							
P-							
P-							

**PLOT PLAN:** Show locations of percolation tests, soil borings and the dimensions of portable soil areas. Indicate surface, existing, described, and the horizontal and vertical elevation reference points and show their location on the plot plan. Show the surface elevations of all borings and the direction and percent of land slope.

#### SYSTEM ELEVATION

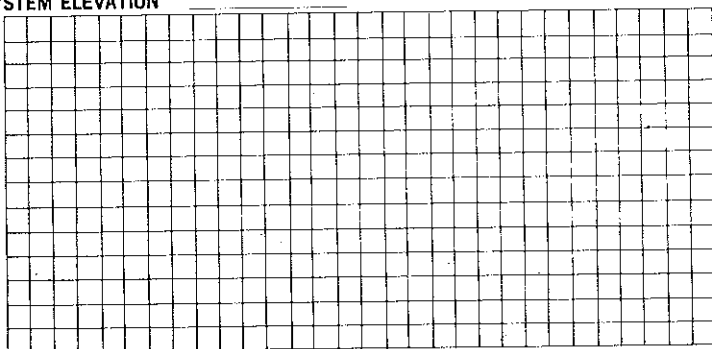

I, the undersigned, hereby certify that the soil tests reported on this form were made by me in accord with the procedures and methods specified in the Wisconsin Administrative Code, and that the data recorded and the location of the tests are correct to the best of my knowledge and belief.

NAME (print)	TESTS MADE TO ORDER	
ADDRESS	CERTIFICATE NO.	PERIOD OF VALIDITY
	DATE OF EXPIRATION	

**DISTRIBUTION:** One copy and certificate to Local Authority, Property Owner and State. Form D-115 (H63.09(1) & Chapter 145.045)

WISCONSIN ADMINISTRATIVE CODE  
ILHR 83 Appendix



APPLICATION FOR SANITARY PERMIT

(PLB 67)

DATE: \_\_\_\_\_  
COUNTY: \_\_\_\_\_

Attach complete plans in accord with s. H 63.05, Wis. Adm. Code for the system or plans that conform to H 63.05.  
See reverse side for instructions for completing this application.

PROPERTY OWNER		PLEASE PRINT	
PROPERTY LOCATION		MAY 1988 ADDRESS	
1/4 1/4 S T N R E (or) W		CITY	
LOT NUMBER	BLOCK NUMBER	SUBDIVISION NAME	TOWNSHIP
TYPE OF BUILDING OR USE SERVED		PERMIT FEE (LATER BY EXPIRATION)	
1 or 2 Family Number of Bedrooms		Public (Spec. 4)	

THIS PERMIT IS FOR A:

<input type="checkbox"/> New System	<input type="checkbox"/> Line Replacement	<input type="checkbox"/> Repair
<input type="checkbox"/> Replacement Soil Absorption System	<input type="checkbox"/> Res. System	<input type="checkbox"/> P. or J.
<input type="checkbox"/> Alternate System	<input type="checkbox"/> Reconnection	<input type="checkbox"/> Port. for New System

IF THIS IS A CONVENTIONAL SYSTEM COMPLETE THIS BLOCK.

<input type="checkbox"/> Septic Bed	<input type="checkbox"/> Sewage Trench	<input type="checkbox"/> Sewage Pit	<input type="checkbox"/> Holding Tank
<input type="checkbox"/> System In-Fill	<input type="checkbox"/> In Ground Pressure	<input type="checkbox"/> Vault Pit	<input type="checkbox"/> Pit Pit
<input type="checkbox"/> Existing, For Which A Previous Permit Is On File Permit # _____			
<input type="checkbox"/> An Existing System That Has Been Impacted And Is Compliant As For A, Soil Composites			

Septic Tank Capacity	Total Capacity		In Ground Pressure		Septic Pit	Holding Tank	Pit Pit
	Gallons	Feet	Feet	Feet			
Life Pump Tank System Chamber							
Holding Tank Capacity							
Manufacturer							

IF THIS IS AN ALTERNATIVE SYSTEM COMPLETE THIS BLOCK.

Septic Tank Capacity	Total Capacity		In Ground Pressure		Septic Pit	Holding Tank	Pit Pit
	Gallons	Feet	Feet	Feet			
Life Pump Tank System Chamber							
Manufacturer							

PERCOLATION RATE (Minutes per inch)	ABSORPTION AREA REQUIRED (Square Feet)	ABSORPTION AREA PROPOSED (Square Feet)	WATER SUPPLY
			Private Joint Public

I, the undersigned, hereby assume responsibility for installation of the private sewage system shown on the attached plans.

Name of Plumber/Plumber	Signature	MP DFRS#	Plumber License
Plumber's Address	Number of Days		

COUNTY/DEPARTMENT USE ONLY

Signature of Issuing Agent	Fee	Date	Approved	Disapproved Owner Given Initial Adverse Determination
Reason for Disapproval				
Alternate course(s) of Action Available				

DILHR 560 6/98 (R 5 82) DISTRIBUTION Original to County One Copy To: Bureau of Planning, Owner, Plumber

**SANITARY PERMIT  
TRANSFER/RENEWAL  
(PLB 67-T)**



COUNTY \_\_\_\_\_

UNIFORM PERMIT # \_\_\_\_\_

PERMIT RENEWAL DATE:	PERMIT TRANSFER DATE:	ORIGINAL PERMIT ISSUANCE DATE:	STATE PLAN I.D. NUMBER:
PROPERTY LOCATION:			
¼	¼ S	T	N, R E (or) W
LOT NUMBER:	BLOCK NUMBER:	SUBDIVISION NAME	
CITY:			
VILLAGE:			
TOWN OF:			
NEAREST ROAD, LAKE OR LANDMARK:			

**PREVIOUS SANITARY PERMIT HOLDER (IF CHANGED):**

NAME:	SIGNATURE:	PHONE NUMBER:	ADDRESS:
SANITARY PERMIT TRANSFERRED TO:		PHONE NUMBER:	ADDRESS:

I, the undersigned, hereby assume responsibility for installation of the private sewage system that has previously been approved for this property.

PLUMBER'S SIGNATURE:	PREVIOUS PLUMBER'S NAME (IF CHANGED):
PLUMBER'S ADDRESS:	PREVIOUS PLUMBER'S ADDRESS:
MP/MPRSW NUMBER:	PHONE NUMBER:
( )	( )

SIGNATURE OF ISSUING AGENT:	DATE APPROVED:
-----------------------------	----------------

**DISTRIBUTION:**  
Original - County  
Copy - Bureau of Plumbing  
Copy - Owner  
Copy - Plumber

DILHR-88D-6399 (R. 5/82)

PLB 68

COUNTY

# SANITARY PERMIT

OWNER \_\_\_\_\_

PLUMBER \_\_\_\_\_ LIC. # \_\_\_\_\_

TOWN OF \_\_\_\_\_ LOCATED \_\_\_\_\_

\_\_\_\_\_ SEC \_\_\_\_\_ T \_\_\_\_\_ NR \_\_\_\_\_

AND/OR LOT \_\_\_\_\_ BLOCK \_\_\_\_\_

\_\_\_\_\_ SUBDIVISION \_\_\_\_\_

### CHAPTER 145.135 WISCONSIN STATUTES

54. The issuance of the sanitary permit is to allow installation of the private sewage system located on the applicant's property.

55. The siting of the sanitary permit is based on regulations in effect at the date of issue.

56. The applicant is to submit the 2 parts from completed set 1 to the permittee for review by the permittee. All plans are to be stamped with the date through the county and their contents are to be stamped with the date.

57. The permittee will not issue the sanitary permit until the applicant has submitted the required information.

58. The sanitary permit is to be based on requirements in effect at the time the permit is issued. Changes in regulations may impact the permit.

59. The sanitary permit is to be based on the requirements in effect at the time the permit is issued. Changes in regulations may impact the permit.

60. The sanitary permit is to be based on the requirements in effect at the time the permit is issued. Changes in regulations may impact the permit.

AUTHORIZED ISSUING OFFICER - DATE \_\_\_\_\_

THIS PERMIT EXPIRES \_\_\_\_\_ UNLESS RENEWED BEFORE THAT DATE

# POST IN PLAIN VIEW

VISIBLE FROM THE ROAD FRONTING THE LOT  
DURING CONSTRUCTION

PLB 68 (2/1985) (1/1/85)

PLB 68-T

COUNTY  
**SANITARY PERMIT**  
TRANSFER/RENEWAL

No. \_\_\_\_\_

OWNER \_\_\_\_\_  
PLUMBER \_\_\_\_\_ LIC. # \_\_\_\_\_  
TOWN OF \_\_\_\_\_ LOCATED \_\_\_\_\_  
SEC. \_\_\_\_\_ T. \_\_\_\_\_ NR. \_\_\_\_\_  
AND/OR LOT \_\_\_\_\_ BLOCK \_\_\_\_\_  
SUBDIVISION \_\_\_\_\_

**CHAPTER 145.135 WISCONSIN STATUTES**

- (1) The authority for sanitary permit is to allow installation of the sanitary sewer line and to regulate the permit.
- (2) The amount of the sanitary permit is based on regulations in force at the date of issue.
- (3) The sanitary permit is valid for 2 years from original date of issuance and may be renewed for similar periods thereafter. Application for renewal must be made through the county and shall comply with regulations in effect at the time.
- (4) Changed regulations will not impair the validity of a sanitary permit until the time of renewal.
- (5) Because of the sanitary permit will be based on regulations in effect at the time permit is issued. Changed regulations may require renewal.
- (6) The sanitary permit is transferable. A sanitary permit holder shall be obtained from the county authority.
- (7) If you wish to know the permit, or transfer responsibility of the permit, please contact the county authority.

AUTHORIZED ISSUING OFFICER - DATE \_\_\_\_\_

THIS PERMIT EXPIRES \_\_\_\_\_ UNLESS RENEWED BEFORE THAT DATE

**POST IN PLAIN VIEW**

VISIBLE FROM THE ROAD FRONTING THE LOT  
DURING CONSTRUCTION

D:\LHR\500\6496\145.135.DOC

SD 5678 (9/81) (Pb 100)

**Detach And Return Upper  
Portion Of This Form With  
Any Return Correspondence**



STATE OF WISCONSIN DILHR  
DIVISION OF SAFETY & BUILDINGS  
BUREAU OF PLUMBING  
201 E. WASHINGTON AVE. RM 178  
P.O. BOX 7969  
MADISON, WI 53707

DWS 908 1245

DATE:

PROJECT

PLAN ID #

DETACH HERE

PROJECT NAME \_\_\_\_\_

PLAN ID # \_\_\_\_\_

**This is to acknowledge receipt of your plans and specifications for the above-indicated project.**

Preliminary review indicates the required fee is \$ \_\_\_\_\_

Fee received is \$ \_\_\_\_\_

- |  |  |
|--|--|
| <input type="checkbox"/> Underpayment - Please submit the additional fee.<br><input type="checkbox"/> Plan accepted for review.<br><input type="checkbox"/> No fee has been remitted. Plans submitted with no fees will be held in abeyance. | <input type="checkbox"/> Overpayment - Refund for the amount Plans being returned.<br><input type="checkbox"/> Additional information required. <b>SEE BELOW</b> |
|--|--|

**I. Plan Submission**

- Additional information shall be submitted in duplicate unless specifically noted.
- Plans not clear, legible or permanent.
- All information submitted shall be signed, dated and sealed or stamped in accord with Section H 63.08(2)(a) Wisconsin Administrative Code.  Affidavit enclosed.

- Complete data relative to anticipated use of bldg.
- 2 copies of P.L.B.D. enclosure.
- Deed restriction required (1 copy).
- Condominium declaration (1 copy)

**II. Pressurize Distribution Systems (Mound or In Ground Pressure)**

- Application for use of an alternative system signed by owner and notarized. (1 copy)
- County onsite required (1 copy).  Design calculations for pressurize distribution.  Soil boring & percolation test data.
- Cross section of system.  Pipe lateral layout.
- Plan view of system.  Plot plan.
- Verification of Exception Status Form by County. (1 copy)

**IV. Holding Tanks**

- Profile of holding tank showing vent, manhole flange and manufacturer if precast. Complete construction details if site constructed.
- Holding tank agreement signed by owner and local unit of government (sample enclosed).
- Reason for installing holding tank. Soil test or statement from county (1 copy).
- Plot plan showing location of holding tank with lateral distances to any building, wells, water service piping, water course, lot lines, swimming pools, all weather service road, etc. Provide benchmark with elevation reference point.

**III. Private Sewage Disposal Systems**

- Ground slope with 2' contours in entire area of soil absorption system extending 25' on all sides.
- Elevation of permanent reference point (benchmark).
- Location of area suitable for replacement system provide soil data.
- Plot plan showing lot size and all lateral distances from sewage disposal system to buildings, lot lines, well, water course, swimming pools, water service piping, etc.
- Construction detail of septic, holding or lift pump tank if site constructed or tank manufacturer if precast.
- Construction detail and cross-section of soil absorption system.
- Soil boring and percolation test on 115 completed by certified soil tester (1 Copy).

**V. Lift Pump**

- Calculations for total lift pump discharge, head and gallons pumped per cycle.
- Size, length & depths of force main.
- Detail & model of pump or automatic siphons including size, pump curves, slowdown and average flow rate GPM.
- Cross section of lift pump tank showing pump(s) or siphon(s).

**VI. Systems in Fill (Fill must be placed prior to plan submission)**

- Total area filled (fill to extend 20' beyond edge of trench before side slope begins).
- Depth and type of fill.
- Copy of onsite report by county or district staff.





WISCONSIN ADMINISTRATIVE CODE  
ILHR 83 Appendix

DEPARTMENT OF INDUSTRY,  
LABOR & HUMAN RELATIONS  
P.O. BOX 7969  
MADISON, WI 53707

INSPECTION REPORT FOR  
PRIVATE SEWAGE SYSTEMS

SAFETY & BUILDINGS DIVISION  
BUREAU OF PLUMBING

CONVENTIONAL		ALTERNATIVE	
Holding Tank		In Ground Pressure	Mound
NAME OF PROPERTY		ADDRESS	
ELEVATION		ELEVATION	
<b>SEPTIC TANK/HOLDING TANK:</b>			
REGION		NUMBER OF FEET FROM NEAREST	
YES	NO	YES	NO
<b>DOSING CHAMBER:</b>			
GALLONS PER CYCLE		NUMBER OF FEET FROM NEAREST	
YES	NO	YES	NO
<b>SOIL ABSORPTION SYSTEM:</b> Check (Personal minimum) at the depth of probing or excavation. (If soil can be pulled into a hole, construction shall cease until the soil is dry enough to continue.)			
<b>CONVENTIONAL SYSTEM:</b>		<b>PIT</b>	
BED/TRENCH DIMENSIONS		NUMBER OF FEET FROM NEAREST	
MOUND SYSTEM:		MOUND SYSTEM:	
Mound site plowed perpendicular to stumps and furrows thrown upslope		Check the texture of the fill material for mound systems to make certain that it meets the criteria for medium sand	
SOIL COVER		PROVIDE A DIAGRAM OF SYSTEM ON REVERSE SIDE. SHOW ELEVATIONS MEASURED.	
PRESSURIZED DISTRIBUTION SYSTEM:		PRESSURIZED DISTRIBUTION SYSTEM:	
BED/TRENCH DIMENSIONS		ELEVATION AND DISTRIBUTION INFORMATION	
COMMENTS:		NUMBER OF FEET FROM NEAREST	

Sketch System on Reverse Side.

Retain in county file for audit

DILHR SBO 6710 (R. 01/82)

CHECKER	TITLE
---------	-------

INDUSTRY, LABOR AND HUMAN RELATIONS  
ILHR 83 Appendix

349



State of Wisconsin \ Department of Industry Labor and Human Relations

SAFETY & BUILDINGS DIVISION

Bureau of Plumbing  
P.O. Box 7959  
Madison, WI 53707

Plan Identification No. \_\_\_\_\_

Re:

Dear Sir:

Plans and specifications have been received and assigned the above plan identification number. Preliminary review of these plans indicate the plans have not been sealed or stamped in accord with Section H 62.25 (2)(a) or H 63.08 (2)(a), Wisconsin Administrative Code.

These sections specifically indicate that all plans shall be sealed or stamped in accord with Chapter A-E 1, Wisconsin Administrative Code. A master plumber or master plumber restricted sewer may design and submit plans and specifications for those systems he is to install. Each sheet of plans and specifications the master plumber or master plumber restricted sewer submits shall be signed, dated and include his license number. Where more than one sheet is bound together into one volume, only the title sheet need be signed, dated and include the license number.

Rather than return the plans at this time, please have the party preparing the plans sign the affidavit below and return to this office.

AFFIDAVIT

I, the undersigned, hereby certify that the plans and specifications submitted and assigned the above project number were prepared by or under my direction and control.

NAME \_\_\_\_\_ TITLE \_\_\_\_\_  
(Type or Print)

REGISTRATION NUMBER \_\_\_\_\_ OR MASTER PLUMBER LICENSE NO. \_\_\_\_\_

ADDRESS \_\_\_\_\_

SIGNATURE \_\_\_\_\_ DATE \_\_\_\_\_

DILHR SBD-6212 (R.08/81)

Plb. = 60  
1/78

**PROJECT DETAIL DATA SHEET**

NAME OF BUSINESS \_\_\_\_\_

LEGAL DESCRIPTION \_\_\_\_\_

OWNER \_\_\_\_\_

MAILING ADDRESS \_\_\_\_\_  
Zip \_\_\_\_\_

ARCHITECT, ENGINEER,  
PLUMBER OR DESIGNER \_\_\_\_\_

ADDRESS \_\_\_\_\_  
Zip \_\_\_\_\_

TELEPHONE NUMBER \_\_\_\_\_

I. Check appropriate building usage(s) and fill in the information requested opposite each usage listed. Please consult Section II 62.20.

Existing building \_\_\_\_\_ New building \_\_\_\_\_ Addition \_\_\_\_\_

- ( ) Apartments and condominiums ..... Number of bedrooms \_\_\_\_\_
- ( ) Assembly hall ..... Seating capacity \_\_\_\_\_
- ( ) Bar ..... Seating Capacity \_\_\_\_\_ # of meals served \_\_\_\_\_
- ( ) Bowling alley ..... Number of lanes \_\_\_\_\_ ( ) With Bar \_\_\_\_\_
- ( ) Campground and camping resorts ..... Number of sewerred sites \_\_\_\_\_  
 ..... Number of unsewerred sites \_\_\_\_\_  
 ..... Total number of sites \_\_\_\_\_
- ( ) Camps ..... ( ) Day use only Number of persons \_\_\_\_\_  
 ..... ( ) Day and night Number of persons \_\_\_\_\_
- ( ) Catchbasin ..... Number \_\_\_\_\_
- ( ) Church ..... ( ) No kitchen Number of persons \_\_\_\_\_  
 ..... ( ) With kitchen Number of persons \_\_\_\_\_
- ( ) Dance hall ..... Number of persons \_\_\_\_\_
- ( ) Dining hall ..... Number of meals served daily \_\_\_\_\_
- ( ) Dog kennels ..... Number of of enclosures \_\_\_\_\_
- ( ) Drive-in restaurant ..... Inside seating capacity \_\_\_\_\_
- ( ) Dump station ..... Number of dump stations \_\_\_\_\_  
 ..... Car-service—Number of car spaces \_\_\_\_\_
- ( ) Employes (total of all shifts) ..... Number of employes \_\_\_\_\_
- ( ) Hotel ( ) Motel ( ) Cottages ..... Number of units with 2 persons per unit \_\_\_\_\_  
 ..... Number of units with 4 persons per unit \_\_\_\_\_
- ( ) Medical and dental office bldgs ..... Number of doctors, nurses, medical staff \_\_\_\_\_  
 ..... Number of office personnel \_\_\_\_\_  
 ..... Number of of patients \_\_\_\_\_
- ( ) Mobile home parks: ..... Number of sites \_\_\_\_\_
- ( ) Nursing homes ..... Number of beds \_\_\_\_\_
- ( ) Parks ..... Number of persons \_\_\_\_\_  
 ( ) Toilets ( ) Showers
- ( ) Restaurant ..... Seating capacity \_\_\_\_\_  
 ..... ( ) Dishwasher and/or disposal?  
 ( ) 24-Hour service
- ( ) Retail store ..... Total number of customers \_\_\_\_\_

**INDUSTRY, LABOR AND HUMAN RELATIONS**      351  
 ILHR 83 Appendix

- ( ) Schools ..... Number of classrooms \_\_\_\_ ( ) Meals ( )  
 Showers  
 ( ) Self service laundry ..... Total number of machines \_\_\_\_\_  
 ( ) Service station ..... Number of cars served daily \_\_\_\_\_  
 ( ) OTHER .....(Specify) \_\_\_\_\_

**COMPLETE OTHER SIDE**

2. Indicate whether the following facilities are present.
- |                          |                  |                                |
|--------------------------|------------------|--------------------------------|
| Floor drain              | yes ____ no ____ | Number of drains ____          |
| Flood waste grinder      | yes ____ no ____ |                                |
| Dishwasher               | yes ____ no ____ |                                |
| Automatic clothes washer | yes ____ no ____ | Number of clothes washers ____ |
3. Septic tank capacity \_\_\_\_\_  
 Holding tank capacity \_\_\_\_\_  
 Septic or holding tank manufacturer \_\_\_\_\_
4. **SEEPAGE TRENCHES:**    Total square feet \_\_\_\_\_ width of trenches \_\_\_\_\_  
 length of trenches \_\_\_\_\_ depth \_\_\_\_\_  
 number of trenches \_\_\_\_\_
- SEEPAGE BEDS:**            total square feet \_\_\_\_\_ width \_\_\_\_\_  
 length of bed \_\_\_\_\_ depth \_\_\_\_\_
- SEEPAGE PITS:**            total square feet \_\_\_\_\_  
 outside diameter \_\_\_\_\_  
 depth below inlet \_\_\_\_\_  
 total depth from top \_\_\_\_\_  
 to bottom of pit: \_\_\_\_\_

Signature of person completing form:      **FOR DEPARTMENTAL USE ONLY**

\_\_\_\_\_

Address \_\_\_\_\_

Zip \_\_\_\_\_

Telephone Number \_\_\_\_\_

Date \_\_\_\_\_



ON-SITE INVESTIGATION FOR  
CONVENTIONAL SYSTEM IN-FILL

Safety & Buildings Division  
Bureau of Plumbing  
P.O. BOX 7969  
MADISON, WI 53707

District Name:		Legal Description:					
Building Usage: <input type="checkbox"/> New Building <input type="checkbox"/> Replacement System <input type="checkbox"/> Public <input type="checkbox"/> Residential		No. of Bedrooms					
Surface Feet Soil Absorption System Required:		Depth in Inches to Limiting Factor From Original Grade		Fill Is Placed To Overcome Depth To: <input type="checkbox"/> Groundwater <input type="checkbox"/> Bedrock		Fill placed 30 Feet Around Area Processed Per Initial And Replacement Area <input type="checkbox"/> Yes <input type="checkbox"/> No	
Are Fill Placed:		Topsoil and Nonandy Soil Removed Prior to Placement of Fill: <input type="checkbox"/> Yes <input type="checkbox"/> No		Vegetation Removed Prior to Placement of Fill: <input type="checkbox"/> Yes <input type="checkbox"/> No		Monitoring Required: <input type="checkbox"/> Yes <input type="checkbox"/> No	
Nature of Fill: <input type="checkbox"/> Natural Low Spreading Soil <input type="checkbox"/> Yes <input type="checkbox"/> No		Indicate Texture of Fill Materials:				Does Fill Conform To Section H 83.10(5) Dis. Admin. Code: <input type="checkbox"/> Yes <input type="checkbox"/> No	

Explain Any Problems:

Complete The Following:

Bench Mark Elevation As Established On 115 \_\_\_\_\_ Finished Grade Elevation \_\_\_\_\_

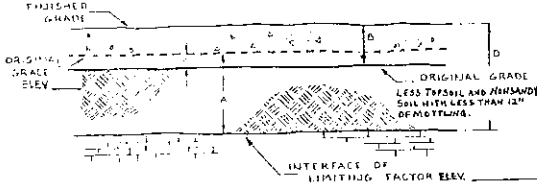

Depth To Limiting Factor:	
A	Depth of Fill Material:
B	Depth of Topsoil and Nonandy Soil With Less Than 12" of Mortling:
C	Finished Depth To Limiting Factor:
D	

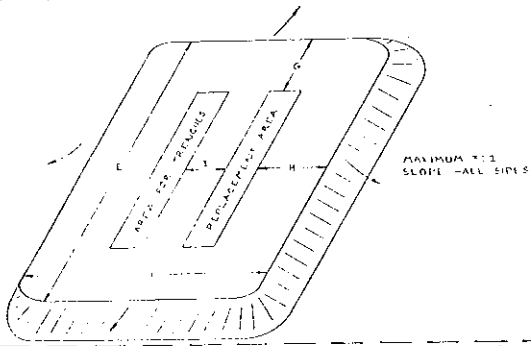

Total Length of Area Filled:	
E	Total Width of Area Filled:
F	Dimension from Proposed Edge of Trench to Edge of Fill (min. 30"):
G	Dimension from Proposed Edge of Trench to Edge of Fill (max. 50"):
H	Separation of Trenches (min. 4'):
I	
J	

Signature of County Representative/On-Site Waste Specialist

DILHR SPD-6196 (R.02/83)

Name: \_\_\_\_\_

Date: \_\_\_\_\_

**GROUND WATER MONITORING:**

**REQUEST FOR ADDITIONAL INFORMATION**

**PLEASE PROVIDE OR CLARIFY THE FOLLOWING:**

- Legal description of property
- Owner's name and mailing address
- Depth and/or location of monitoring wells
- Monthly rainfall
- Daily rainfall data for March, April and May
- Observations and reporting of data is incomplete
- Plot plan required showing location of all monitoring wells
- Surface elevation of all monitoring wells
- Information regarding artificial drainage
- EH-115: Report on Soil Borings and Percolation Tests
- Data report form not signed by Certified Soil Tester
- Data not submitted on PLB. 119 form
- Data not submitted in duplicate—one additional copy required
- Verification of data and procedures from county



Plan Identification No. \_\_\_\_\_

Gentlemen:

We have received a (PLB. 119) Groundwater Monitoring Report form from \_\_\_\_\_, CST for the \_\_\_\_\_ property located in the \_\_\_\_\_

Please answer or verify the following and return to this office. Monitoring data will be reviewed upon receipt of this information.

1. Were you notified by the CST of the intent to monitor groundwater levels at the above-mentioned site?
2. Were the wells properly installed?
3. Provide all observations you made during the time the site was monitored.
4. Did the soil tester monitor the site according to chapter ILHR 83, Wis. Adm. Code?
5. List any comments or pertinent information.

\_\_\_\_\_  
Signature of Person Completing Form



STATE OF WISCONSIN-DEPARTMENT OF INDUSTRY, LABOR & HUMAN RELATIONS  
 DIVISION OF SAFETY & BUILDINGS - BUREAU OF PLUMBING  
 P.O. BOX 7969 - MADISON, WI, 53707

## APPLICATION FOR THE USE OF AN ALTERNATIVE SYSTEM

Location:					Township/Municipality:	
$\frac{1}{2}$	$\frac{1}{2}$ S	T	N/R	E(or)W		
Street Address:					Subdivision:	County:
Landowners Name:					Mailing Address:	

I (We), the undersigned, hereby make application for an alternative system on the above-described premises. I recognize that the above premises are not suited for a conventional private sewage system. If approval is granted, I agree to have the system installed in conformance with the Bureau's approval of plans and specifications.

I further understand that an alternative system is more complex in nature than a conventional private sewage system and as such will require detailed inspection during construction and monitoring after the system is put into use. I agree to permit both county officials charged with administering county sanitary ordinances and Bureau employees or other authorized persons to have access to the above described premises at any reasonable time for the purpose of inspection the construction of or monitoring of the system. I further agree to either personally or by my agent contact the proper county official to arrange the time and date to begin construction of the system.

I understand that this application does not permit me (the applicant) or my agent (the contractor) to begin installation. If the system is approved, the Bureau will send the applicant a letter of approval which authorizes construction of the alternative system after all necessary permits have been obtained.

I agree to give notice to any subsequent buyer that an application for an alternative system has been made and if installed, that the premises are served by an alternative system and further agree to give the buyer a copy of this application.

The Bureau accepts this application subject to this understanding and subject to all the conditions and obligations set out in this application.

STATE OF WISCONSIN }  
 COUNTY OF \_\_\_\_\_ } ss.

\_\_\_\_\_  
 Signature of Applicant Date

Subscribed and sworn to before me

This \_\_\_\_\_ day of \_\_\_\_\_ 19\_\_.

\_\_\_\_\_  
 Notary Public, State of Wisconsin

DIIHR-SBD-6413 (N. 05/81)

My Commission Expires: \_\_\_\_\_

INDUSTRY, LABOR AND HUMAN RELATIONS 357  
ILHR 83 Appendix

DILHR SBD-6698  
(Pib.89)

APPLICATION FOR DEVELOPMENT OF FLOOD PLAIN  
DEPARTMENT OF INDUSTRY, LABOR & HUMAN RELATIONS

When the installation of a new, replacement or expanded private sewage disposal system is proposed for a flood plain area, this form must be completed and submitted to the Department of Industry, Labor & Human Relations along with plans and other necessary data.

OWNER'S NAME \_\_\_\_\_ DATE \_\_\_\_\_

ADDRESS \_\_\_\_\_

ADDRESS OF BUILDING OR LOCATION OF PROPERTY \_\_\_\_\_

LEGAL DESCRIPTION \_\_\_\_\_

TOWNSHIP \_\_\_\_\_ COUNTY \_\_\_\_\_

Is this system new \_\_\_\_\_ replacement \_\_\_\_\_ expanded \_\_\_\_\_.

Is area:

In regional floodway? yes \_\_\_\_\_ no \_\_\_\_\_ not determined \_\_\_\_\_

In regional fringe flood area? yes \_\_\_\_\_ no \_\_\_\_\_ not determined \_\_\_\_\_

Contiguous to ground higher than any of the above? yes \_\_\_\_\_ no \_\_\_\_\_

What is the established regional flood elevation? \_\_\_\_\_

Are flood plain maps published and available or determined by the Department of Natural Resources? \_\_\_\_\_

Has or will permission be granted for the following:

Fill required for building? yes \_\_\_\_\_ no \_\_\_\_\_

Building permit? yes \_\_\_\_\_ no \_\_\_\_\_

Sewage disposal system (sanitary permit)? yes \_\_\_\_\_ no \_\_\_\_\_

Action taken locally by \_\_\_\_\_

Comments regarding development (zoning administrator, board of appeals, etc.):

Favorable \_\_\_\_\_ Unfavorable \_\_\_\_\_

Special Recommendations: \_\_\_\_\_

\_\_\_\_\_  
\_\_\_\_\_  
\_\_\_\_\_  
\_\_\_\_\_  
\_\_\_\_\_  
\_\_\_\_\_  
\_\_\_\_\_

Signatures:

County Representative \_\_\_\_\_

Department of Natural Resources \_\_\_\_\_

Department of Industry, Labor & Human Relations \_\_\_\_\_

NOTE: This document is to be recorded in the Tract Index at the office of the Register of Deeds in the county indicated below.

### HOLDING TANK AGREEMENT

This Agreement is made and entered into this \_\_\_\_\_ day of \_\_\_\_\_, 19\_\_\_\_, by \_\_\_\_\_ and \_\_\_\_\_ between the \_\_\_\_\_, hereinafter called "\_\_\_\_\_" and \_\_\_\_\_ hereinafter called the "Owner".

We hereby acknowledge that application has been made for a building permit on the following described property, to wit:

or that continued use of the existing premises requires that a holding tank be installed on the property for the purpose of proper containment of sewage. We also acknowledge that said property cannot now be served by a municipal sewer or septic tank-soil absorption system.

THEREFORE, as an inducement to the County of \_\_\_\_\_ to issue a sanitary permit for the above described premises, we hereby agree and bind ourselves as follows:

1. Owner agrees to conform to all applicable requirements of the Plumbing Code relating to holding tanks. Any time the Town or Municipality of \_\_\_\_\_, through its Plumbing Inspector or Health Officer, deems it necessary to pump out the subject holding tank, the Owner shall have same pumped out in twenty-four (24) hours, or \_\_\_\_\_ will have said work done and charge same back to Owner and place same on the tax bill as a special charge. The Owner further agrees that the Town or Municipality of \_\_\_\_\_ may enter upon the property described above at any reasonable time, to inspect, or pump and haul wastes from the subject holding tank.

2. Owner agrees to pay all charges and costs incurred by the Town or Municipality of \_\_\_\_\_ for inspection, pumping, hauling or otherwise servicing and maintaining the subject holding tank in such a manner as to prevent or abate any nuisance or health hazard caused by such holding tank. \_\_\_\_\_ shall notify the Owner of any such cost which shall be paid by Owner within thirty (30) days from the date of notice and in the event that the Owner does not pay said cost within thirty (30) days, Owner hereby specifically agrees that all of said costs and charges may be placed on the tax roll as a special assessment for the abatement of nuisance, and said tax shall be collected as provided by Wisconsin Statute.

3. Owner agrees to have a quarterly pumping report submitted to the local government and the county which will state the Owner's name, location of the property on which the holding tank is located, the pumper's name, the dates, volumes pumped and the disposal site. An annual pumping report or the fourth quarter report including a summary of the pumping history of the previous year shall be submitted to the Department of Industry, Labor and Human Relations by the governmental unit responsible, per section 145.01 (15), Wisconsin Statutes.

4. We guarantee that the holding tank contents will be disposed of at a site meeting the requirements of chapter NR 113, Wisconsin Administrative Code.

5. This agreement will remain in effect only until the sanitary permit issuing agent in \_\_\_\_\_ County certifies that the subject property is served by either a public sewer or a septic tank-soil absorption system that complies with ch. ILHR 83, Wis. Adm. Code. In addition, this Agreement may be cancelled by executing and recording said certification with reference to this Agreement, in the Tract Index indicated above.

(OVER)

Page 2

6. This agreement shall be binding upon the indicated governmental unit and the Owner or heirs and assignees and shall run with the deed.

WITNESS our hands and seals this \_\_\_\_\_ day of \_\_\_\_\_ .

SIGNATURE OF TOWN OR MUNICIPAL OFFICIAL (Include Title): \_\_\_\_\_

\_\_\_\_\_  
SIGNATURE OF OWNER(S): \_\_\_\_\_

\_\_\_\_\_  
Personally came before me this \_\_\_\_\_ day of \_\_\_\_\_, 19\_\_\_\_, the above named \_\_\_\_\_ to me known to be the persons who executed the foregoing instrument and acknowledged the same.

THIS INSTRUMENT  
DRAFTED BY:

\_\_\_\_\_  
NOTARY PUBLIC

My commission expires:

SANITARY PERMIT SUBMITTAL FORM

COUNTY \_\_\_\_\_

DATE \_\_\_\_\_

TOTAL AMOUNT \_\_\_\_\_

TOTAL PERMITS \_\_\_\_\_

PERMITS BY NUMBER AND DATE ISSUED:

This form must accompany each group of Sanitary Permits upon submission for State Funding.

PLEASE USE ADDITIONAL SHEETS IF NECESSARY.

D ILHR-SB 6153 (N. 7/80)

INDUSTRY, LABOR AND HUMAN RELATIONS 361  
 ILHR 83 Appendix

Wisconsin Department of  
**DILHR**  
 Industry, Labor and Human Relations

# MATERIAL REQUEST

STATE OF WISCONSIN DILHR  
 DIVISION OF SAFETY & BUILDINGS  
 BUREAU OF PLUMBING  
 201 E. WASHINGTON AVE, RM 178  
 P.O. BOX 7969  
 MADISON, WI 53707

PLEASE MAIL ALL REQUESTS TO:

COUNTY OF _____	TELEPHONE _____	ADDRESS CHANGE: <input type="checkbox"/> YES <input type="checkbox"/> NO
MAILING ADDRESS: _____	_____	ZIP CODE _____

FORM NO.:	TITLE OF MATERIALS REQUESTED:	QUANTITY ORDERED:	QUANTITY SENT:
PLB - 68	SANITARY PERMIT		
PLB - 68T	SANITARY PERMIT TRANSFER		
SRD - 6398	PERMIT APP. FOR PRIVATE DOMESTIC SEWAGE SYSTEMS (PLB-67)		
SBD - 6399	TRANSFER FORM FOR SANITARY PERMIT (PLB-67T)		
SBD - 6095	REPORT ON INSPECTION OF SANITARY PERMIT		
SBD - 6153	SANITARY PERMIT SUBMITTAL		
SBD - 6395	REPORT ON SOIL BORINGS AND PERCOLATION TESTS (115)		
SBD - 6421	GROUNDWATER MONITORING REPORT (PLB-119)		
SBD - 6309	RPT. ON SOIL BORINGS AND PERC. TESTS- SUBDIVISION (EH-44)		
SBD - 6413	APPLICATION FOR AN ALTERNATIVE SYSTEM (PLB-108)		
SBD - 6158	VERIFICATION FOR THE USE OF AN ALTERNATIVE SYSTEM		

STATE USE ONLY-ASSIGNMENT OF SANITARY PERMIT NUMBERS!

01000

THE FOLLOWING PERMIT NUMBERS ARE ASSIGNED TO THE COUNTY IDENTIFIED ABOVE

(PLB-68) PERMIT NO. \_\_\_\_\_ THROUGH & INCLUDING \_\_\_\_\_ PERMITS

(PLB-68T) PERMIT NO. \_\_\_\_\_ THROUGH & INCLUDING \_\_\_\_\_ PERMITS

INITIALS: _____	DATE SHIPPED _____
-----------------	--------------------

TOTAL PERMITS ISSUED
----------------------

(Date of Issue)  
**CONFIRMATION OF SANITARY PERMITS RECEIVED**

001000

COUNTY OF _____	DATE RECEIVED BY COUNTY _____
PERMIT NUMBERS: _____ THROUGH: _____	SIGNATURE OF ISSUING AGENT _____

DILHR SBD-6232 (N. 6/81)

WISCONSIN DEPARTMENT OF INDUSTRY, LABOR AND HUMAN RELATIONS  
 DIVISION OF SAFETY & BUILDINGS, BUREAU OF PLUMBING  
 P.O. BOX 7969, MADISON, WISCONSIN 53707

Verification of Exception Status for an Alternative Private Sewage System  
 In the County of \_\_\_\_\_

Location \_\_\_\_\_ 1/4, \_\_\_\_\_ 1/4, Sec. \_\_\_\_\_, T \_\_\_\_\_ N, R \_\_\_\_\_ E (or) W

Town or Municipality \_\_\_\_\_ Street Address \_\_\_\_\_

Lot No. \_\_\_\_\_, Block \_\_\_\_\_, Subdivision \_\_\_\_\_

Landowner's Name: \_\_\_\_\_

The application for this site is for:

- new construction use.  
 replacement system use.

If this is NEW CONSTRUCTION USE, the alternative private sewage system is:

- to have one of the first five approvals guaranteed for this year. This is number \_\_\_\_\_ of those applications. (Use one of the first five quota numbers issued to you.)  
 one of the applications needing a quota number. The quota number assigned to this application is \_\_\_\_\_.  
 for one additional homesite on a farm to be occupied by a parent, child, grandchild, sibling, niece, nephew, or first cousin.  
 for an individual lot for which a sanitary permit was issued but was later ruled unsuitable due to new or changed soil criteria established by the department.  
 for an application on file prior to February 1, 1980.  
 for a lot that meets the criteria for a conventional private sewage system.

If this is a REPLACEMENT SYSTEM USE, the alternative private sewage system is replacing:

- a failing conventional soil absorption system.  
 a holding tank that was installed and in use prior to February 1, 1980.  
 a privy that was installed and in use prior to February 1, 1980.

If this is a REPLACEMENT SYSTEM USE and the lot meets the criteria for a conventional private sewage system, check here.

I certify that the above information is true and accurate to the best of my knowledge.

Name \_\_\_\_\_ Signature \_\_\_\_\_  
 (County Official)

Title \_\_\_\_\_ Date \_\_\_\_\_

DILHR-SBD-6158 (R 12/82)

PRIVY INSTALLATION AGREEMENT

NOTE: This document is to be recorded in the Tract Index at the office of the Register of Deeds in the county indicated below.

COPY TO BE ATTACHED TO PLB. 67 WHEN APPLYING FOR A SANITARY PERMIT

PROPERTY OWNER:	MAILING ADDRESS:
LOCATION: 1/4 1/4 S / T N/R E (or) W	CITY, VILLAGE OR TOWNSHIP: COUNTY:

I (we) acknowledge the following privy installation conditions:

- No plumbing will be installed on the premises. Plumbing means any piping, fixtures, equipment, devices or appurtenances in connection with water supplies, water distribution and drainage systems, including hot water storage tanks, water softeners and water heaters connected with such water and drainage systems.
- The privy will not be erected within 50 feet of any well, stream or lake, 25 feet of a door or window of any building, 10 feet of the line of any street or public thoroughfare and 5 feet of a property line. Set backs not mentioned shall not be less than those shown in section H63.10(1), (Wis. Administrative Code).
- The privy will not be installed on soils that do not have at least 3 feet of soil below the bottom of the proposed excavation that is free of periodic saturation or bedrock. Where these conditions cannot be met a vault constructed in accordance with section H63.18(6), Wisconsin Administrative Code will be used.
- The soil condition has been verified by an appropriate county official or certified soil tester as signed here.
- The privy will be installed: (mark one)  over a soil pit  over a vault.
- This agreement shall be binding on the owner(s) or heirs and assignees.

SIGNATURE AND TITLE:

OWNER(S): OWNER(S):

STATE OF WISCONSIN

Personally came before me this \_\_\_\_\_ day of \_\_\_\_\_, 19\_\_\_\_, the above named \_\_\_\_\_

\_\_\_\_\_ to me known to be the persons who executed the foregoing instrument and acknowledged the same.

THIS INSTRUMENT DRAFTED BY: NOTARY PUBLIC: MY COMMISSION EXPIRES:

DILHR--SD--6432 (R. 3/82)



OPTIONAL WORKSHEET

I. MOUND SYSTEM

1. Wastewater Load, Total Daily Flow = \_\_\_\_\_ gal.  
Use section H 63.15 (3) (f), Wis. Adm. Code and PROVIDE A DETAILED LIST OF SIZING ON PLANS.
2. Depth to Limiting Factor = \_\_\_\_\_ ft.
3. Landscape = \_\_\_\_\_ %
4. Distance from Dose Chamber to Distribution System = \_\_\_\_\_ ft.
5. Elevation Difference Between Pump and Distribution System = \_\_\_\_\_ ft.
6. Absorption Area Sizing:  
Area Required = \_\_\_\_\_ sq. ft.  
Bed or Trench Length (B) = \_\_\_\_\_ ft.  
Bed or Trench Width (A) = \_\_\_\_\_ ft.  
Trench Spacing (C) = \_\_\_\_\_ ft.
7. Mound Height:  
Fill Depth (D) = \_\_\_\_\_ ft.  
Fill Depth Downslope (E) = \_\_\_\_\_ ft.  
Bed or Trench Depth (F) = \_\_\_\_\_ ft.  
Cap and Topsoil Depth (H) = \_\_\_\_\_ ft.
8. Mound Length:  
End Slope (K) = \_\_\_\_\_ ft.  
Total Mound Length (L) = \_\_\_\_\_ ft.
9. Mound Width:  
Upslope Correction Factor = \_\_\_\_\_  
Dipslope Correction Factor = \_\_\_\_\_  
Downslope Width (I) = \_\_\_\_\_ ft.  
Total Mound Width (W) = \_\_\_\_\_ ft.
10. Basal Area:  
Infiltrative Capacity of Natural Soil = \_\_\_\_\_ gal./sq.ft./day  
Basal Area Required = \_\_\_\_\_ sq. ft.  
Basal Area Available = \_\_\_\_\_ sq. ft.
11. If Standard Tables from Chapter H 63 are Used, Indicate Table No. \_\_\_\_\_
12. For the Distribution Network, Use Numbers 5-14 in Section II.

II. IN-GROUND PRESSURE SYSTEM

1. Depth to Limiting Factor = \_\_\_\_\_ ft.
2. Landscape = \_\_\_\_\_ %
3. Percolation Rate = \_\_\_\_\_ min./in.
4. Proposed System Elevation = \_\_\_\_\_ ft.
5. Wastewater Load, Total Daily Flow: Use section H 63.15 (3) (e), Wis. Adm. Code and PROVIDE A DETAILED LIST OF SIZING ON PLANS.  
Required Septic Tank Capacity = \_\_\_\_\_ gal.
6. Absorption Area Sizing:  
Percolation Rate = \_\_\_\_\_ min./in.  
Area Required = \_\_\_\_\_ sq. ft.  
System Length = \_\_\_\_\_ ft.  
System Width = \_\_\_\_\_ ft.
7. Distribution Pipe Sizing:  
Hole Size = \_\_\_\_\_ in.  
Hole Spacing = \_\_\_\_\_ ft.  
Lateral Length = \_\_\_\_\_ ft.  
Lateral Size = \_\_\_\_\_ in.  
Lateral Spacing = \_\_\_\_\_ ft.  
Distance from Sidelwall to Pipe = \_\_\_\_\_ in.
8. Distribution Pipe Discharge Rate:  
Number of Holes Per Pipe = \_\_\_\_\_  
Flow Per Pipe = \_\_\_\_\_ gpm.
9. Manifold Sizing:  
Type (center or end) = \_\_\_\_\_  
Length = \_\_\_\_\_ ft.  
Diameter = \_\_\_\_\_ in.

III. IN-GROUND PRESSURE SYSTEM Continued

10. Force Main:  
Minimum Discharge Rate = \_\_\_\_\_ gpm.  
Diameter = \_\_\_\_\_ in.
11. Total Dynamic Head:  
System Head = \_\_\_\_\_ 2.5 ft.  
Vertical Lift = \_\_\_\_\_ ft.  
Friction Loss = \_\_\_\_\_ ft.  
TDH = \_\_\_\_\_ ft.
12. Pump Selection:  
Pump will discharge at least \_\_\_\_\_ gpm.  
at \_\_\_\_\_ ft. total dynamic head.  
Pump model and manufacturer = \_\_\_\_\_
13. Dose Volume:  
10 Times Void Volume of Distribution Lines = \_\_\_\_\_ gal.  
Daily Wastewater Volume = \_\_\_\_\_ gal.  
4 Doses in 24 hrs = \_\_\_\_\_ gal.  
Backflow = \_\_\_\_\_ gal.  
Minimum Dose = \_\_\_\_\_ gal.
14. Dose Chamber:  
Volume = \_\_\_\_\_ gal.

III. CONVENTIONAL PRIVATE SEWAGE SYSTEM

1. Wastewater Load, Total Daily Flow = \_\_\_\_\_ gal.  
Use section H 63.15 (4) (f), Wis. Adm. Code and PROVIDE DETAILED LIST OF SIZING ON PLANS.
2. Required Septic Tank Capacity = \_\_\_\_\_ gal.
3. Percolation Rate = \_\_\_\_\_ min./in.
4. Absorption Area Sizing:  
Refer to Table 2 in chapter H 63 and PROVIDE A DETAILED LIST OF SIZING ON PLANS.  
Required Area = \_\_\_\_\_ sq. ft.  
Length = \_\_\_\_\_ ft.  
Width = \_\_\_\_\_ ft.  
Number of Trenches = \_\_\_\_\_  
Trench Spacing = \_\_\_\_\_ ft.
5. Distribution System:  
Lateral Length = \_\_\_\_\_ ft.  
Number of Laterals = \_\_\_\_\_  
Lateral Spacing = \_\_\_\_\_ in.  
Distance from Sidelwall to Pipe = \_\_\_\_\_ in.  
System Elevation = \_\_\_\_\_ ft.

IV. SYSTEM-IN-FIELD

Fill in All Items from Section III

V. SEPTIC TANK

1. Capacity = \_\_\_\_\_ gal.
2. Manufacturer = \_\_\_\_\_
3. Show Site Constructed Tank Details on Plan

VI. DOSING TANK

1. Capacity = \_\_\_\_\_ gal.
2. Manufacturer = \_\_\_\_\_
3. Pump Model = \_\_\_\_\_
4. Operating Head = \_\_\_\_\_ ft.
5. Flow Rate = \_\_\_\_\_ gpm.
6. \_\_\_\_\_
7. Show Site Constructed Tank Details on Plans

VII. HOHLINE TANK

1. Capacity = \_\_\_\_\_ gal.
2. Manufacturer = \_\_\_\_\_
3. Show Site Constructed Tank Details on Plans

—SHOW ALL INFORMATION ON PLANS—

DILHR SBD 6761 (R. 03/82)

**INDUSTRY, LABOR AND HUMAN RELATIONS**      **365**  
**ILHR 83 Appendix**



**PRIVATE SEWAGE SYSTEMS**  
**PLAN APPROVAL APPLICATION**

STATE OF WISCONSIN DILHR  
DIVISION OF SAFETY & BUILDINGS  
BUREAU OF PLUMBING  
201 E. Washington Avenue, Rm 118  
P.O. Box 7969, Madison, WI 53707  
608-268-3915

**INSTRUCTIONS:** Please fill in all applicable data and submit this form with plans. Plans will not be reviewed until all fees are received. The back side of this form describes required plan information. Plumbing codes can be purchased from the Department of Administration, Document Sales, 207 South Thornton Ave., Madison, Wisconsin 53703, Telephone (608) 266-3358.

<b>1. PROJECT INFORMATION (Type or print clearly)</b>			Revision To Plan Number:		
Name of Submitting Party (Plans returned to same)			Project Name		
Street & No. or Rural Route			Project Location - Street & No. or Legal Description		
City or Village	State	Zip	City Village <input type="checkbox"/> OF: Town <input type="checkbox"/>	County	
Telephone No. (Include area code)					
Designer	Telephone No. (Include area code)		Owners Name	Telephone No. (Include area code)	
Street & No.			Street & No.		
City or Village	State	Zip	City or Village	State	Zip

**2. APPLICATION FOR:**

- |  |   |  |
|--|---|--|
| <input type="checkbox"/> Conventional System - Public Building (1) | <input type="checkbox"/> New Mound System (3a)      | <input type="checkbox"/> Holding Tank (2)              |
| <input type="checkbox"/> Replacement Pressurized System (4b)       | <input type="checkbox"/> Replacement Mound (4a)     | <input type="checkbox"/> Petition For Modification (6) |
| <input type="checkbox"/> New Pressurized System (3b)               | <input type="checkbox"/> System in Fill (1)         | <input type="checkbox"/> Other Alternatives (5)        |
|  | <input type="checkbox"/> System in Flood Fringe (1) |  |
|  | <input type="checkbox"/> Groundwater Monitoring (7) |  |

**3. FEE COMPUTATIONS (Include existing tanks)**

MAKE ALL CHECKS PAYABLE TO DILHR

3a. 750 - 1,500 gallon septic tank	- 30.00
3b. 1,501 - 2,500 gallon septic tank	- 40.00
3c. 2,501 - 4,000 gallon septic tank	- 55.00
3d. 4,001 - 8,000 gallon septic tank	- 70.00
3e. 8,001 - 12,000 gallon septic tank	- 85.00
3f. Over 12,000 gallon septic tank	- 100.00

3g. 500 - 1,000 gallon dose chamber	- 30.00
3h. 1,001 - 2,000 gallon dose chamber	- 35.00
3i. 2,001 - 4,000 gallon dose chamber	- 50.00
3j. 4,001 - 8,000 gallon dose chamber	- 65.00
3k. 8,001 - 12,000 gallon dose chamber	- 80.00
3l. Over 12,000 gallon dose chamber	- 95.00

3m. 500 - 5,000 gallon holding tank	- 30.00
3n. 5,001 - 10,000 gallon holding tank	- 40.00
3o. Over 10,000 gallon holding tank	- 50.00

3p. Groundwater Monitoring Per Lot (other than a proposed subdivision)	- 32.00
3q. Priority plan review: (walk through) Submittal of plans in person, by appointment, with double fee	
3r. Petition for Modification	
Setback	- 20.00
Site evaluation	- 50.00

**4. FEE SUBMITTED**

**FOR OFFICE USE**

4a. _____	_____
4b. _____	_____
4c. _____	_____
4d. _____	_____
4e. _____	_____
4f. _____	_____
4g. _____	_____
4h. _____	_____
4i. _____	_____
4j. _____	_____
4k. _____	_____
4l. _____	_____
4m. _____	_____
4n. _____	_____
4o. _____	_____
4p. _____	_____
Subtotal	_____
4q. _____	_____
4r. _____	_____
Total Fee	_____

DILHR-SBD-6748 IR. 02/83)

NOTE: Fees subject to change on July 1, annually.

-OVER

The following information is required for plan review. An index page or each page of the plans must be signed, sealed and dated by the designer.

- 6. MOUNDS & IN-GROUND PRESSURE DISTRIBUTION SYSTEMS**
- 5a. Application for Use of an Alternative System (IDILHR-SBD-6413) signed by owner and notarized.
- 5b. County on-site
- 5c. Verification form signed by county (IDILHR-SBD-6158).
- 5d. 115 photocopy.
- 5e. Plot plan showing lot size and all lateral distances from the system to buildings, wells, watercourses, etc. Show permanent reference points. Direction and percent of slope or two foot contours must be included. Provide system elevation for in-ground pressure, show area for replacement if for new construction. (TWO COPIES).
- 5f. Plan view of system with observation pipes and permanent lateral markers (TWO COPIES).
- 5g. System cross section (TWO COPIES).
- 5h. Pipe lateral layout (TWO COPIES).
- 5i. Construction detail of septic tank if site-constructed, or manufacturer if prefabricated (TWO COPIES).
- 5j. Dosing Chamber cross section with construction details if site-constructed (TWO COPIES).
- 5k. Pump or siphon model, performance curve, total dynamic head calculations and minimum dose volume (TWO COPIES).
- 5l. If the site is suitable for a conventional private sewage system, items a and b from this section are not required.
- 6. CONVENTIONAL PRIVATE SEWAGE SYSTEMS**
- 6a. Photocopy of soil test (115) by CST, including data for replacement system, if new construction.
- 6b. Project Detail Data Sheet providing all sizing information (TWO COPIES).
- 6c. Plot plan showing location of septic tank, soil absorption system and replacement area. Indicate lateral distances to any buildings, well, water courses, lot lines, etc. The plot plan must also show the location of permanent horizontal and vertical reference points (benchmark). Also indicate ground slope with 2 foot contours in entire area, extending 25 feet on all sides of initial and replacement systems. (TWO COPIES).
- 6d. Plan view of soil absorption system showing all dimensions, pipe lengths, spacing, etc. (TWO COPIES).
- 6e. Cross section of soil absorption system showing system elevation, aggregate, cover material, depths, etc. (TWO COPIES).
- 6f. Construction detail of septic tank if site-constructed, or manufacturer if prefabricated (TWO COPIES).
- 6g. Detail of lift pump tank or automatic siphon, tank size, gpm, gallons per cycle, vertical lift, friction loss, etc. (TWO COPIES).
- 7. HOLDING TANKS**
- 7a. Photocopy of soil test (115) by CST. A full evaluation must be made to eliminate the possibility of any other system being installed.
- 7b. Agreement document between owner and local unit of government, notarized and recorded in reference to the deed. This agreement must include a statement about the quarterly pumping report.
- 7c. Plot plan showing location of holding tank with lateral distances to any buildings, well, water service piping, water courses, lot lines, etc. Provide horizontal and vertical reference points. Include all-weather service road within ten feet of the service pass. (TWO COPIES).
- 7d. Holding tank profile showing vent, manhole, alarm and manufacturer if prefabricated. Complete construction details if site-constructed. (TWO COPIES).
- 7e. Project Detail Data Sheet providing all sizing information (TWO COPIES). This is not required for residential installations where the number of bedrooms is indicated on the plans.
- 8. SYSTEMS IN FILL**
- 8a. Systems in fill must include an on-site investigation form (IDILHR SBD-6196), as well as all of the appropriate items listed in sections 6.
- 9. GROUNDWATER MONITORING**
- 9a. 115 photocopy (TWO COPIES).
- 9b. Groundwater Monitoring Report (IDILHR-SBD-6412) (TWO COPIES).
- 9c. Verification of data and procedures from county (TWO COPIES).
- 9d. Precipitation data.
- 10. PETITION FOR MODIFICATION**
- 10a. Private Sewage Petition for Modification Form (IDILHR-SBD-6669).

# INDUSTRY, LABOR AND HUMAN RELATIONS

ILHR 83 Appendix

367

STATE OF WISCONSIN  
 DILHR-DIVISION OF SAFETY & BUILDINGS  
 BUREAU OF PLUMBING  
 P.O. BOX 7969  
 MADISON, WISCONSIN 53707



WISCONSIN PRIVATE SEWAGE SYSTEM  
 COUNTY AUDIT  
 SECTION 175.19 (D), WISCONSIN STATUTES

CALENDAR YEAR 1982

<p>1. ORDINANCE &amp; PERSONNEL</p> <p>1. County Ordinance Adopted? YES NO</p> <p>2. Ordinance - Complies H 637 YES NO</p> <p>3. Changes to Ordinance Since Approval? YES NO</p> <p>4. County Participates in the Wisconsin Fund? YES NO</p> <p style="padding-left: 20px;">a. No. of Orders Issued _____</p> <p style="padding-left: 20px;">b. No. of Grants Applied For _____</p> <p style="padding-left: 20px;">c. No. of Grants Approved _____</p> <p style="padding-left: 20px;">d. No. of Systems Installed _____</p> <p style="padding-left: 20px;">e. No. of Maintenance Reports Required _____</p> <p style="padding-left: 20px;">f. No. of Maintenance Reports Filed _____</p> <p style="padding-left: 20px;">g. No. of Orders or Enforcement Actions Against Non-Filers _____</p> <p style="padding-left: 20px;">h. Total Dollar Value of Grants _____</p> <p>5. Total Number of Staff _____</p> <p>6. No. of Certified Inspectors _____</p> <p>7. No. of Certified Soil Testers _____</p> <p style="padding-left: 20px;">a. CST Co. Employee? YES NO</p> <p style="padding-left: 20px;">b. Name and Reg. No. of CST(s)                  _____                  _____                  _____</p> <p style="padding-left: 20px;">c. CST on Contract? YES NO</p> <p style="padding-left: 40px;">Name and Reg. No. of CST(s)                  _____                  _____</p> <p style="padding-left: 20px;">d. Contract Available for Review? YES NO</p> <p>II. PERMITS</p> <p>1. No. of Sanitary Permits Issued Jan. 1, 1982 through Dec. 31, 1982 _____</p> <p>2. No. of Permits New Construction _____</p> <p>3. No. of Permits State Facilities _____</p> <p>4. No. of Permits Replacement (SAS) _____</p> <p>5. No. of Permits Replacement (Tank Only) _____</p> <p>6. No. of Permits for Repair _____</p> <p>7. No. of Permits Transferred _____</p> <p>8. No. of Permit Renewals _____</p> <p>9. No. of Permits Submitted to the Department _____</p> <p>10. No. of Permits Rescinded _____</p> <p>11. No. of Permit Applications Rejected on Review _____</p>	<p>III. SYSTEM INSTALLATIONS &amp; INSPECTION</p> <table border="0" style="width: 100%;"> <tr> <td style="width: 60%;"></td> <td style="width: 10%;"></td> <td style="width: 10%; text-align: center;">NEW</td> <td style="width: 10%; text-align: center;">REPLACE- MENT</td> </tr> </table> <p>1. No. of Systems Installed in Following Categories:</p> <p style="padding-left: 20px;">A. Conventional</p> <p style="padding-left: 40px;">1. Gravity Type _____</p> <p style="padding-left: 40px;">2. Inground Pressure _____</p> <p style="padding-left: 20px;">B. Alternate System</p> <p style="padding-left: 40px;">1. Mound _____</p> <p style="padding-left: 40px;">2. Inground Pressure _____</p> <p style="padding-left: 40px;">3. Other _____</p> <p style="padding-left: 20px;">C. Holding Tanks _____</p> <p style="padding-left: 20px;">D. Privies _____</p> <p style="padding-left: 20px;">E. Repaired/Altered _____</p> <p style="padding-left: 20px;">F. Replacement Tanks _____</p> <p>2. No. of Systems Inspected _____ of _____</p> <p style="padding-left: 20px;">a. Was Every System Inspected Prior to Backfill? YES NO</p> <p>3. No. of Construction Inspections _____</p> <p style="padding-left: 20px;">a. New _____</p> <p style="padding-left: 20px;">b. Replacement _____</p> <p style="padding-left: 20px;">c. Repaired/Altered _____</p> <p>4. No. of Failing System Inspections _____</p> <p>5. Other Inspections (Specify in Summary) _____</p> <p>6. Total No. of Inspections _____</p> <p>IV. ENFORCEMENT ACTIONS</p> <p>1. Construction Directives and Orders</p> <p style="padding-left: 20px;">a. No. of Field Directives _____</p> <p style="padding-left: 20px;">b. No. of Directives Complied With _____</p> <p style="padding-left: 20px;">c. No. of Orders Issued (After Directive) _____</p> <p style="padding-left: 20px;">d. No. of Orders Complied With _____</p> <p style="padding-left: 20px;">e. No. of Orders Taken to Corp Counsel/DA _____</p> <p style="padding-left: 20px;">f. No. of Orders Enforced _____</p> <p>2. Failing System Inspections</p> <p style="padding-left: 20px;">a. No. of Failing System Insp. _____</p> <p style="padding-left: 20px;">b. No. of Failing Systems Replaced W/O Orders _____</p> <p style="padding-left: 20px;">c. No. of Orders for Replacement _____</p> <p style="padding-left: 20px;">d. No. of Systems Not Replaced After Orders _____</p> <p style="padding-left: 20px;">e. No. of Orders Taken to DA/Corp Counsel _____</p> <p style="padding-left: 20px;">f. Orders Enforced by DA/Corp Counsel _____</p>			NEW	REPLACE- MENT
		NEW	REPLACE- MENT		

DILHR-58D-6461(R.5/82)

V. COUNTY ADMINISTRATION

1. Building Permits Required by the County? YES NO

2. Land Use or Zoning Permit Issued by the County? YES NO

a. No. of Towns Requiring Building Permits \_\_\_\_\_ of \_\_\_\_\_

b. No. of Villages Requiring Building Permits \_\_\_\_\_ of \_\_\_\_\_

c. No. of Cities Requiring Building Permits \_\_\_\_\_ of \_\_\_\_\_

3. County Filing System:

a. No. of Soil Test Reports Filed With County \_\_\_\_\_

b. 1. Does the County Review All Soil Test Reports? YES NO

2. No. of (115) Soil Reports Verified in the Field \_\_\_\_\_

c. 115 - Soil Tests Accepted Are Completed Properly: vg - g - f - p - vp

d. Does the County Review All Plans for 1 & 2 Fam. Dwellings? YES NO

e. Does the County Have an Effective Filing System For:

1. 115's Before Permit Issuance? YES NO

2. Plans Before Construction? YES NO

3. Plans After Construction? YES NO

f. PLB 67's Accepted are Completed Properly?: vg - g - f - p - vp

4. No. of Written Notices of Sanitary Permit Rejection \_\_\_\_\_

5. Budget

a. Revenue From Sanitary Permit Issuance \_\_\_\_\_

b. Revenue From State Aids \_\_\_\_\_

c. Revenue From Inspection Fees \_\_\_\_\_

d. County Program Self Supporting or Tax Funded \_\_\_\_\_

\_\_\_\_\_ % GPR \_\_\_\_\_ % PRO

TOTAL BUDGET \_\_\_\_\_

e. Fee for County Sanitary Permit \_\_\_\_\_

1. Fee If different for Alternate Systems \_\_\_\_\_

2. Fee if different for Holding Tanks \_\_\_\_\_

3. Fee if different for Replacement Tanks \_\_\_\_\_

4. Fee for Inspection \_\_\_\_\_

5. Fee for Wisconsin Fund \_\_\_\_\_

6. Fee for Transfer \_\_\_\_\_

7. Fee for Plan Exaa \_\_\_\_\_

8. Fee for Privy \_\_\_\_\_

9. Fee for Renewal \_\_\_\_\_

10. Fee for Revision \_\_\_\_\_

VI. RANDOM FIELD REVIEW

1. Random Review in the Field 5 Systems Installed where Permits Were Issued During Calendar Year 1984. Attach Summary.

a. % of Random Reviews Installed as Shown on Plans \_\_\_\_\_

2. Review a Random Sample of Alternative Systems Installed During the Calendar Year. Randomly Select 10% or 5 Systems, whichever is Greater, or All of the Alternates if Less than 5 were Installed. \_\_\_\_\_

a. % of Random Alternates Installed as Shown on Plans \_\_\_\_\_

VII. ON-SITE WASTE SPECIALIST USE ONLY

1. No. of Orders/Directives Issued by OWS This County \_\_\_\_\_

2. No. of Soil Onsites by OWS This Co. \_\_\_\_\_

3. No. of Failing System Inspections by OWS This County \_\_\_\_\_

4. No. of Construction Inspections by OWS This County \_\_\_\_\_

5. No. of Seminars by OWS This County \_\_\_\_\_

6. No. of Persons Attending Seminars \_\_\_\_\_

VIII. OILHR USE ONLY

1. No. of Sanitary Permits Received \_\_\_\_\_

2. No. of Sanitary Permits Sent to Co. \_\_\_\_\_

From No. \_\_\_\_\_ To No. \_\_\_\_\_

TOTAL = \_\_\_\_\_

5. Receipts Total Dollars \$ \_\_\_\_\_

6. Aid to County Distributed \$ \_\_\_\_\_

7. Wisconsin Fund Monies to County \$ \_\_\_\_\_

INDUSTRY, LABOR AND HUMAN RELATIONS  
ILHR 83 Appendix

369



Department of Industry, Labor and Human Relations  
Division of Safety & Buildings  
Bureau of Plumbing  
P.O. Box 7969  
Madison, WI 53707  
Te). (608) 266-3815

IN ALL CORRESPONDENCE  
REFER TO PLAN  
IDENTIFICATION NO.

\_\_\_\_\_  
\_\_\_\_\_  
\_\_\_\_\_

NAME OF PROJECT

- PRIVATE SEWAGE ONLY -  
 GENERAL PLUMBING PLANS

LOCATION

CITY OR TOWN

COUNTY

Fee Received:  
Priority Plan Review Only

Examination of plumbing plans and specifications for this project has been completed. In accord with Chapter 145, Wisconsin Statutes and the Wisconsin Administrative Code, the plumbing plans and specifications are approved contingent upon compliance with the stipulations shown on the plans. Please review your code for the requirements of each code section noted.

The licensed plumber responsible for this installation shall keep at the construction site one set of plans bearing the department's stamp of approval. The installer shall also notify the appropriate inspector of when required inspections are to be made.

In the event installation has not begun within two years from this date, approval will be void and new plan approval shall be obtained before work may begin.

In granting this approval, the Division of Safety and Buildings does not hold itself liable for any defects in plans or specifications, plan omissions or examination oversight, and reserves the right to order changes or additions if necessary.

This approval is based on Wisconsin Administrative Code requirements. It shall be necessary to obtain and fulfill the permit requirements of the city, village, township or county in which this installation is to be made. Failure to obtain local permits will automatically void this approval.

Sincerely,

*James Sargent*  
James Sargent  
Bureau Director

PLANS REVIEWED BY:

DATE:

cc: OPS - OWS  
Local PI  
County

Owner  
Plumber  
Other

H & R & Rec. San. Section  
Bur. of Health Fac. & Services

DILHR SBD-6099 (R. 05/82)

Petition for Modification of an Administrative Rule <b>PRIVATE SEWAGE</b>	WISCONSIN DEPARTMENT OF INDUSTRY, LABOR AND HUMAN RELATIONS DIVISION OF SAFETY & BUILDINGS P.O. BOX 7969, MADISON, WI 53707	OFFICE USE ONLY
		Petition No.
		IO-No.

Name of Owner	Building Occupancy or Use	Agent, Architect or Engineering Firm or Master Plumber
Company	Tenant Name, if any	
Street & No.	Building Location, Street & No.	Street & No.
City State & Zip	City County	City State & Zip
Phone	Plan Number (if known)	Phone

Type of Petition	<input type="checkbox"/> Set Backs (Soil Absorption and Septic Systems)	<input type="checkbox"/> Experimental and Loading Rates	<input type="checkbox"/> Site Evaluations
Fee \$ _____			
<b>LEGAL DESCRIPTION</b>			
_____ 1/4, _____ 1/4, Section _____, T _____ N, R _____ E (or) W, Township _____			
Subdivision Name _____ County _____			

<b>WISCONSIN ADMINISTRATIVE RULE BEING PETITIONED</b>
1. Rule _____ of the Wisconsin Administrative code cannot be entirely satisfied due to the following reasons: _____ _____ _____
2. In lieu of complying exactly with the rule, the following alternative is proposed as a means of providing an equivalent degree of safety or health: _____ _____ _____
3. Supporting arguments (For site evaluations, include Form 115—"Report on Soil Boring and Percolation Tests") _____ _____ _____

INDUSTRY, LABOR AND HUMAN RELATIONS 371  
 ILHR 83 Appendix

<b>DETAILED PLAN OR DRAWING</b>					
<b>COUNTY PERSONNEL AUTHORIZATION</b>			Rule _____ being petitioned		
On-site inspection conducted (date) _____					
I, _____, indicate the information recorded on this request form is accurate and correct to the best of my knowledge and belief.					
<b>VERIFICATION BY OWNER--PETITION IS VALID ONLY IF NOTARIZED.</b> <b>FOR INFORMATION CONTACT THE DEPARTMENT AT (608) 266-3815</b>					
_____ being duly sworn, says he is petitioner herein, thus he has read the foregoing petition and that the same is true, as he verily believes.					
Subscribed and sworn to me this _____ day of 19 _____,					
_____ County, Wisconsin.			Signature of owner,		
_____ Notary Public					
My commission expires: _____					
<b>OFFICE USE ONLY</b>					
<b>DEPARTMENT ACTION</b>					
<b>SITE EVALUATIONS</b>			<b>SET-BACK OR EXPERIMENTAL</b>		
Date Received	Amount Paid	Receipt No.	Date Received	Amount Paid	Receipt No.
Department Action			Department Action		
ADMINISTRATOR		Date	BUREAU DIRECTOR OR DESIGNEE		Date



As the sanitary permit issuing agent in the county stated below, I hereby certify that the following described property is now served by either a public sewer or a septic tank — soil absorption system that complies with ch. ILHR 83, Wis. Adm. Code.

NOTE: This document is to be recorded in the Tract Index at the office of the Register of Deeds in the county indicated below.

CANCELLATION OF A HOLDING TANK AGREEMENT

As the sanitary permit issuing agent in the county stated below, I hereby certify that the following described property is now served by either a public sewer or a septic tank — soil absorption system that complies with ch. H 63, Wis. Adm. Code.

In addition, I understand that execution and recording of this document cancels a holding tank agreement between the \_\_\_\_\_ and \_\_\_\_\_ that was recorded on the \_\_\_\_ day of \_\_\_\_\_, 19\_\_ in volume \_\_\_\_\_, page \_\_\_\_ as document number \_\_\_\_\_.

Witness my hand and seal this \_\_\_\_ day of \_\_\_\_\_, 19\_\_.  
County of \_\_\_\_\_  
by \_\_\_\_\_ (include title)

STATE OF WISCONSIN

Personally came before me this \_\_\_\_ day of \_\_\_\_\_, 19\_\_.  
the above named \_\_\_\_\_,  
to me known to be the person who executed the foregoing instrument and acknowledged the same.

THIS INSTRUMENT  
DRAFTED BY:

\_\_\_\_\_  
NOTARY PUBLIC

MY COMMISSION EXPIRES:

\_\_\_\_\_

### DESIGN OF PRESSURE DISTRIBUTION NETWORKS FOR SOIL ABSORPTION FIELDS

To obtain uniform application of wastewater effluent over the entire infiltrative surface of a soil absorption field, pressure distribution systems are required. Section H 63.14 specifies the design criteria for pressure distribution systems. They are designed by balancing the headlosses such that the volume of water passing out each hole in the network will be equal. This is achieved by allowing 75 to 85 percent of the total headloss in the network to be lost when the water passes through the hole while only 10 to 15 percent of the total headloss occurs in delivering the water to each hole.

Since the design can become quite tedious, a simplified method has been developed by the use of the tables and nomographs in s. 63.14. With this method, only a straight edge and pencil is needed to complete the design. To demonstrate the use of the tables and nomographs, this example is given.

Example:

Design a pressure system for a soil absorption system consisting of 5 trenches, each 3 feet wide by 40 feet long. The trenches are to be spaced 9 feet on center.

Step 1: Select the desired distribution pipe length from the dimensions of the required soil absorption area. Two layouts would be suitable for this system. The distribution pipes in each trench may be fed by a manifold along one end of the trenches or by a central manifold. In the first design, 5 distribution pipes are used, each 40 feet long. In the second design, there are 8 distribution pipes, each 20 feet long. The first design will be used in this example.

Step 2: Select an appropriate distribution pipe diameter compatible with the chosen hole diameter and hole spacing from Table 5.

Holes in  $\frac{1}{4}$ -in diameter spaced every 2.5 feet will be used in this example, though other combinations would be just as suitable. From Table 5, either a 1  $\frac{1}{4}$ -in or 1  $\frac{1}{2}$ -in distribution pipe is required for a 40 foot distribution pipe. Select the larger 1  $\frac{1}{2}$ -in diameter distribution pipe.

Step 3: Determine the total discharge rate of each distribution pipe and the number of holes required by using the nomograph in Table 6.

Place a straight edge on the nomograph in Table 6 aligning the 40 foot mark on the Distribution Pipe Length scale with the 2.5 ft mark on the Hole Spacing scale. Where the straight edge crosses the Number of Holes scale, read off the number of holes per distribution pipe; 16 in this example. To obtain the distribution pipe discharge rate, realign the straight edge to join the 16 mark on the Number of Holes scale with the  $\frac{1}{4}$ -in mark on the Hole Diameter scale. Where the straight edge crosses the Distribution Pipe Discharge scale, the discharge rate is given. In this example, it is nearly 20 gpm as shown.

Step 4: Select the appropriate manifold size based on the number, length and discharge rate of the distribution pipes from Table 7. For central manifold designs use the lower column headings and left

row headings. For end manifold designs, use the lower column headings and the right row headings. (If necessary, repeat steps 1 through 4 until an acceptable network is laid out.)

The manifold length is that length of pipe required to connect all the distribution pipes downstream from the manifold inlet. In this example, the inlet to the manifold is to be at one end. There are to be 5 distribution pipes spaced 9 feet apart requiring a manifold 36 feet long. Since an end manifold design is to be used, the flow per distribution pipe of 20 gpm (from step 3) is read on the right side of Table 7, the number of 5 read on the bottom under the manifold length at 35 feet. In this design, a 3-in manifold is sufficient (See Table 7.) (If the inlet had been in the center of the manifold, the manifold length would have been 18 feet serving 2 distribution pipes. In that case, the manifold could be 2-in diameter.)

**Step 5:** Determine the minimum dose volume required based on the total pipe volume from the nomograph in Table 11.

On the nomograph in Table 11, the straight edge is placed on 1½-in mark on the Distribution Pipe Diameter scale (from step 2), and the 40 mark on the Distribution Pipe Length scale. The volume of the distribution pipe is read off the Pipe Volume scale. In this example, it is approximately 3.7 gal. Next, turn the straight edge maintaining the point on the Pipe Volume scale and align it with 5 on the Number of Distribution Pipes scale. The minimum dose volume read off the Dose Volume scale is approximately 200 gal. However, the final dose volume selected may be larger than this minimum depending on the desired number of doses per day. (See s. ILHR 83.14 (6), Wis. Adm. Code).

**Step 6:** Determine the minimum pump or siphon discharge rate from the nomograph in Table 8.

Using the nomograph in Table 8, the dosage rate is read from the Dosing Rate scale by aligning the straight edge with 20 gpm on the Distribution Pipe Discharge Rate scale (step 3) with 5 on the Number of Distribution Pipes scale. The minimum rate is 100 gpm.

**Step 7:** Select the proper pump or siphon from the head-discharge characteristics described by the manufacturers.

The total dynamic head of the network must first be computed. For a pump system, this is equal to the elevation differences between the pump and the distribution pipe inverts, the friction loss in the pipe which delivers the liquid from the pump to the distribution system at the required rate, and 3 feet of head to compensate for losses in the distribution system. The pump able to pump the minimum discharge rate at the total dynamic head computed is selected.

Siphon selection is based on the manufacturer's stated average discharge rate. This rate is for free discharge. Therefore, to maintain this rate, the siphon discharge pipe invert must be elevated above the distribution pipe inverts a distance equal to the estimated distribution system. These losses included the friction loss in the delivery pipe from the siphon to the network at the minimum discharge rate determined in step 7 plus 3 feet of head

to compensate for losses within the distribution system. Where the delivery pipe is more than 50 feet long, its diameter should be one size larger than the siphon discharge diameter to facilitate air venting.

Assume the dosing tank is located 25 feet from the distribution system inlet, and the difference in elevation between the pump and the inverts of the distribution pipes is 5 feet. At a rate of 100 gpm the headloss in 100 feet of a 3-in plastic delivery pipe can be read from Table 9. Therefore, for 25 feet the headloss is  $2.09 \text{ feet} \times 25 \text{ feet}/100 \text{ ft} = 0.52 \text{ ft}$ . The total dynamic head of the system is 5 feet of elevation head plus 0.5 feet of friction head in the delivery pipe plus 3 feet of account for losses in the distribution system. Therefore, a pump should be selected which is able to pump at least 100 gpm against 8.5 feet of head.

If a siphon were used, its discharge invert would be elevated 0.5 feet plus 3 feet or a minimum of 3.5 feet above the distribution pipe inverts.

In summary, the final design consists of five 40 foot distribution pipes, each 1½-in. in diameter connected with a 3-in end manifold with the inlet from the dosing chamber at one end of the manifold. The inverts of the distribution pipes are perforated with ¼-in holes spaced every 2.5 feet. The first hole should be located one half of the hole spacing or 1.25 feet from the manifold. If the last hole is equal to or greater than half the hole spacing from the end of the distribution pipe, put another hole in the bottom of the cap or next to it.



## Chapter ILHR 84

### PLUMBING FIXTURES AND MATERIALS

ILHR 84.01	Scope (p. 377)	ILHR 84.20	Plumbing fixtures (p. 378)
ILHR 84.03	Penalties (p. 377)	ILHR 84.30	Plumbing materials (p. 384)
ILHR 84.10	Department approval (p. 377)	ILHR 84.40	Joints and connections (p. 390)
ILHR 84.11	Identification of fixtures and materials (p. 377)	ILHR 84.50	Alternate, experimental materials and engineered plumbing systems (p. 396)
ILHR 84.12	Existing installations (p. 378)	ILHR 84.60	Incorporation of standards by reference (p. 397)
ILHR 84.13	Penetrations of fire resistive assemblies (p. 378)		

**ILHR 84.01 Scope.** The provisions of this chapter govern the quality of all materials, fixtures and equipment used in the alteration, repair or installation of plumbing.

History: Cr. Register, February, 1985, No. 350, eff. 3-1-85.

**ILHR 84.03 Penalties.** Penalties for violations of this chapter shall be assessed in accordance with ss. 145.12 and 145.25, Stats.

History: Cr. Register, February, 1985, No. 350, eff. 3-1-85.

**ILHR 84.10 Department approval.** No plumbing fixture, material or device may be sold or installed, unless it is of an approved type conforming to the applicable standards referenced in ch. ILHR 82 or this chapter.

(1) Plumbing fixtures, materials and devices submitted to the department for approval shall be accompanied by sufficient data and information for the department to judge if the item and its performance meets the requirements of chs. ILHR 82 to 84.

(2) The department may impose specific conditions in granting the approval for a plumbing fixture, material or device, including an expiration date for the approval. Violations of those conditions under which an approval is granted shall constitute a violation of this chapter.

(3) The department may require testing of a plumbing fixture, material or device to be made or repeated, if, anytime, there is reason to believe that the item no longer conforms to the requirements of chs. ILHR 82 to 84 and the conditions of approval.

(4) The department may revoke any approval issued under this section for any false statements or misrepresentation of facts on which the approval was based.

(5) An approval of a plumbing fixture, material or device by the department shall not be construed, as an assumption of any responsibility for defects in design or construction of any item nor for any damages that may result.

(6) Plumbing products submitted with all applicable engineering information and complying with nationally accepted standards shall be approved or rejected by the department within 30 business days of receipt of the required information.

History: Cr. Register, February, 1985, No. 350, eff. 3-1-85.

**ILHR 84.11 Identification of fixtures and materials.** Each length of pipe and each fitting, trap, fixture material and device used in a plumbing

## ILHR 84

system shall have cast, embossed, stamped, or indelibly marked on it the maker's mark or name, the weight and quality of the product or shall be identified in accordance with the applicable approved standard. All materials and devices used in the construction of a plumbing system or parts thereof shall be marked and identified in a manner satisfactory to the department.

History: Cr. Register, February, 1985, No. 350, eff. 3-1-85.

**ILHR 84.12 Existing installations.** In existing buildings or premises in which plumbing installations are to be altered, repaired or renovated, the department may permit deviation from the provisions of this chapter provided that such a proposal to deviate is first submitted to the department for proper determination and approval in accordance with the procedures of s. ILHR 82.20 (12).

History: Cr. Register, February, 1985, No. 350, eff. 3-1-85.

**ILHR 84.13 Penetrations of fire resistive assemblies.** Penetrations of fire-resistive assemblies, such as walls and floor-ceiling systems, by plumbing systems or plumbing materials shall be protected in accordance with requirements of chs. ILHR 50 to 64.

Note: See Appendix for further explanatory material.

History: Cr. Register, February, 1985, No. 350, eff. 3-1-85.

**ILHR 84.20 Plumbing fixtures.** (1) **CONSTRUCTION AND DESIGN.** All plumbing fixtures, appliances, equipment, devices and appurtenances shall be of such design, materials and construction as to comply with applicable standards listed in s. ILHR 84.60, to insure durability, proper service, sanitation, and so as to not entail undue efforts in keeping them clean and in proper operating condition.

(a) All plumbing fixtures shall connect directly to the sanitary plumbing system, except as otherwise specified.

(b) Blowout type fixtures may only be installed upon approval of the department.

(2) **WATER CONSERVING FIXTURES.** Pursuant to s. 145.25, Stats., all water closets, lavatory faucets, urinals and shower heads shall be of an approved water conserving type, except as permitted in par. (d).

(a) *Design.* Test data for water conserving fixtures submitted for department approval shall be based on 50 pounds per square inch water pressure.

(b) *Prohibitions.* 1. All buildings. No person may sell at retail or install in or cause to be installed in any building:

a. A water closet which uses more than 4 gallons of water per flush; and

b. A shower head which uses more than 3 gallons of water per minute.

2. Public restrooms. No person may install or cause to be installed in any public restroom:

a. Any urinal intended for use by male persons which is operated by an automatic urinal flushometer valve or hand-operated flushometer valve which uses more than 1.5 gallons of water per flush per fixture use;

b. Any automatic siphon urinal flush tanks; or

c. Any lavatory faucet which allows more than one gallon of water to flow through the faucet after the handle is released.

Note: Cr. The force required to activate a lavatory faucet to be used by a handicapped person is not to exceed 5 pounds.

3. Dwelling units. No person may install or cause to be installed any faucet connected to a lavatory in any dwelling unit which allows more than 3 gallons of water per minute to flow through the faucet.

(c) *Listing of water conserving fixtures.* 1. Water closets. The department shall publish a list of water closet models which have been certified by the manufacturer to use no more than 4 gallon per flush.

2. Shower heads. The department shall publish a list of shower heads which have been manufactured, tested and certified by the manufacturers to permit not more than 3 gallons per minute to flow through the head.

3. Urinals and urinal flushing devices. The department shall publish a list of all urinals and urinal flushing devices which have been manufactured, tested and certified by the manufacturer to permit not more than 1.5 gallons per flush per fixture use to flow through the valve or fixture.

4. Lavatory faucets. a. The department shall publish a list of all lavatory faucets which have been manufactured, tested and certified by the manufacturers to permit not more than one gallon of water to flow through the faucet after release of the handle.

b. The department shall publish a list of all faucets which have been manufactured, tested and certified by the manufacturer to permit not more than 3 gallons of water per minute to flow through the faucet.

6. Flow control and flow restrictor devices. a. Flow control or restricting devices shall be installed on the water inlet side of the faucet or shall be an integral part of the faucet. A flow controlling or restricting aerator shall be considered as an integral part of a faucet.

b. All flow control and flow restrictive devices manufactured, tested and certified by the manufacturer shall limit the flow through the unit to the test and certification rate. The device shall not be removable without special knowledge or effort.

7. Identification. All water conserving fixtures and devices shall be permanently marked for identification as required in s. ILHR 84.11.

8. Manufacturer's responsibilities. A manufacturer desiring to have a product included on the department's published lists of water conserving fixtures and devices shall submit for each water conserving fixture or device laboratory test data, engineering data, or certification by the manufacturer that a fixture or device meets the provisions of this chapter and a copy of the sales brochure.

(d) *Exemptions.* 1. Availability. When a water conserving device or fixture is not available from 2 or more manufacturers, compliance with this subsection may be waived by the department.



2. Waiver. The department, upon request, may waive compliance with flushing requirements established by s. 145.25, Stats., and this subsection, if the following conditions prevail:

a. Existing buildings. Any building in existence or under construction on or before January 1, 1979, if its drain system design or installation requires a greater quantity of water to function properly.

b. Public sewer design. If any building is served by a public sewer which requires a greater quantity of water to maintain flow.

(3) GENERAL REQUIREMENTS. (a) *Fixture outlets*. 1. The outlet passageway of a fixture shall be free from impairments and of sufficient size to insure proper discharge of the fixture contents under normal conditions.

2. Outlet connections which are directly connected to the plumbing system shall be such that a permanent air and watertight joint can be readily made between the fixture and drainage system.

(b) *Installation of fixtures*. 1. Access for cleaning. Plumbing fixtures shall be so installed as to afford easy access for cleaning both the fixture and the area around it.

2. Watertight joints. Joints formed where fixtures come in contact with walls or floors shall be sealed.

3. Securing wall mounted fixtures. Wall mounted fixtures shall be rigidly supported by a concealed hanger which is attached to structural members so that the load is not transmitted to the fixture drain connection or any other part of the plumbing system. The hanger shall conform to ANSI A112.6.

4. Water supply protection. The water supply pipes and fittings for every plumbing fixture shall be so installed as to prevent backflow.

5. Design of overflow. A fixture which is provided with an overflow outlet shall be designed and installed so that standing water in the fixture cannot rise in the overflow when the fixture's stopper is closed, nor shall any water remain in the overflow when the fixture is empty.

6. Connection of overflows. The overflow from any fixture shall discharge into the drainage system on the inlet or fixture side of the trap.

7. Overflows in flush tanks. Flush tanks shall be provided with overflows discharging to the fixture served and shall be of sufficient size to prevent flooding the tank at the maximum rate at which the tanks are supplied with water. The opening of the overflow pipe shall be located above the flood level rim of the fixture served.

8. Strainers. All plumbing fixtures other than water closets, clinic sinks, trap standard service sinks with flush rims, and siphon action or washdown urinals shall be provided with strainers, cross bars or pop-up stoppers which restrict the clear opening of the waste outlet.

9. Flushometer valves. Flushometer valves shall be equipped with vacuum breakers which conform to ASSE 1001. Flushometer valves shall not be used where the water pressure is insufficient to properly operate them. When the valve is operated, it shall complete the cycle of operation automatically, opening fully and closing positively under the water

line pressure. Each flushometer shall be provided with a means for regulating the flow through it.

10. Safing. All shower stalls, shower rooms, floor setting service sinks or receptors, sunken bathtubs or other similar fixtures shall be provided with 4 pound sheet lead asphaltum coated, compositite, copper, chloraloy or other approved safing material beneath the entire fixture or room and upward along the sides to a minimum of 6 inches above the curb or maximum water level of the fixture. The corners shall be safed to a height of 6 feet and at least 3 inches in each direction from the corners. The safing shall be properly drained. Prefabricated fixtures and installations directly over an unexcavated portion of a building are exempt from safing requirements.

**Note:** Chapters ILHR 50 to 64 contain provisions for toilet rooms and sanitary facilities, for public buildings and places of employment concerning toilet facilities for the handicapped, fixture compartments, number of fixtures for the different types of occupancies and toilet room finishes.

**Note:** See Appendix for further explanatory material.

(4) **PLUMBING FIXTURES.** (a) *Water closets.* 1. Water closets shall conform to ANSI A112.19.2M or ANSI Z124.4.

2. Water closets in public buildings and places of employment shall have elongated bowls and hinged, open-front seats without covers.

3. Water closets in individual living units, day care centers, individual executive offices, and sleeping units of hotels and motels may be of the round bowl type, provided with a hinged, closed-front seat, with or without a cover.

4. In nurseries, schools and other similar places where plumbing fixtures are provided for the use of children under 6 years of age, water closets may be of a size and height suitable for the children's use.

5. All water closet seats shall be of smooth nonabsorbent material.

6. Each water closet shall be individually equipped with an acceptable flush tank and fittings or with an approved flushometer valve. All flush tanks and flushometer valves shall be readily accessible for maintenance and repair. Ballcocks shall be of the anti-siphon type and shall conform to ASSE 1002. The ballcock backflow preventer shall be located at least 1 inch above the full opening of the overflow pipe.

7. A water closet shall not be located closer than 15 inches from its center to any side wall, partitions, vanity, or other obstruction, nor closer than 30 inches center to center, between toilets. There shall be at least 24 inches clearance in front of the water closet to any wall, fixture or door.

**Note:** See Appendix for further explanatory material.

8. It shall be prohibited to install or maintain pan, plunger, offset washout, washout, long hopper, frostproof and other types of water closets having invisible seals or unventilated spaces or walls not thoroughly cleansed at each flushing.

(b) *Urinals.* 1. Urinals shall conform to ANSI A112.19.2M.

2. A urinal shall not be located closer than 16 inches from its center to any side wall, partition, vanity or other obstruction, nor closer than 30

inches center to center, between urinals. When the space between stall type urinals or a stall type urinal and a side wall is less than 12 inches, such a space shall be filled flush with the front and top of the urinal with nonabsorbent material.

Note: See Appendix for further explanatory material.

3. Stall type urinals shall be set into the floor and the floor shall be graded toward the fixture.

(c) *Bidets*. Bidets shall conform to the material requirements in ANSI A112.19.2M.

1. A bidet shall not be located closer than 15 inches from its center to any side wall, partition, vanity or other obstruction, nor closer than 30 inches center to center from a water closet.

2. Bidets submerged inlet fittings shall be protected by vacuum breakers which conform to ASSE 1001.

(d) *Lavatories*. 1. Lavatories shall conform to a ANSI A112.19.1M, ANSI A112.19.2M, ANSI A112.19.3, ANSI A112.19.4 or ANSI Z124.3.

2. Cultured marble vanity tops with an integral lavatory shall conform to ANSI Z124.3.

3. Lavatories shall have waste outlets not less than 1¼ inches in diameter.

(e) *Bathtubs*. 1. Bathtubs shall conform to ANSI A112.19.1M, ANSI A112.19.4 or ANSI Z124.1.

2. Bathtubs shall have waste outlets and overflows at least 1½ inches in diameter. A pop-up stopper or other closing device shall be provided on the waste outlet.

(f) *Showers*. 1. Prefabricated showers and shower compartments shall conform to ANSI Z124.2.

2. Every water supply riser from the shower valve to the shower head outlet, whether exposed or not, shall be securely attached to the structure.

3. Except for combination bathtub-shower units, waste outlets serving showers shall be at least 2 inches in diameter and shall have removable strainers not less than 3 inches in diameter having strainer openings not less than ¼ inch in minimum dimension.

4. Where a waste outlet serves more than one shower space or shower head, the waste outlet shall be at least 2 inches in diameter and the waste outlet shall be so located and the floor so pitched, that waste water from one shower does not flow over the floor area serving another shower.

5. All shower compartments, regardless of shape, shall have a minimum finished interior of 900 square inches and shall be capable of encompassing a 30 inch circle. The minimum required area and dimension shall be measured at an height 24 inches above the top of the threshold and at a point tangent to its centerline. The minimum area and dimensions shall be maintained to a point 70 inches above the shower waste outlet with no

protrusions other than the fixture valve or valves, showerheads, soap dishes and safety grab bars or rails.

Note: See Appendix for further explanatory material.

(g) *Sinks*. 1. Sinks shall conform to ANSI A112.19.1M, ANSI A112.19.2M, ANSI A112.19.3 or ANSI A112.19.4.

2. Sinks shall be provided with waste outlets not less than 1½ inches in diameter. Sinks on which a food grinder is installed shall have a waste opening not less than ¾ inches in diameter.

(h) *Food waste grinders*. 1. Domestic food waste grinders shall conform to ASSE 1008. Commercial food waste grinders shall conform to ASSE 1009.

2. Domestic food waste grinders shall be connected to a drain of not less than 1½ inches in diameter.

3. Commercial food waste grinders shall be connected to a drain of sufficient size to serve the unit, but not less than 2 inches in diameter. Commercial food waste grinders shall be connected and trapped separately from any other fixtures or sink compartments.

4. All food waste grinders shall be provided with an adequate supply of cold water at a sufficient flow rate to insure proper functioning of the unit.

(i) *Dishwashing machines*. Domestic dishwashing machines shall conform to ASSE 1006. Commercial dishwashing machines shall conform to ASSE 1004.

(j) *Automatic clothes washers*. Domestic automatic clothes washers shall conform to ASSE 1007.

(k) *Laundry trays*. 1. Laundry trays shall conform to ANSI A112.19.1M or ANSI A112.19.3.

2. Each compartment of a laundry tray shall be provided with a waste outlet not less than 1½ inches in diameter.

(l) *Floor drains*. 1. Floor drains shall conform to ANSI A112.21.1.

2. Floor drain traps shall have a minimum water seal of 2 inches and shall be provided with removable strainers. The floor drain shall be so constructed that it can be readily cleaned, and the drain inlet shall be readily accessible at all times.

3. Floor drains shall be of a size to efficiently serve their intended purpose. The outlet pipe shall not be less than 2 inches in diameter.

(m) *Drinking fountains*. 1. Drinking fountains and water coolers shall conform to ARI 1010 or ANSI A112.19.2M.

2. Drinking fountains shall not be installed in public restrooms or private bathrooms.

3. The water supply for drinking fountains shall be provided with an adjustable valve fitted with a loose key or an automatic self-closing valve permitting regulation of the rate of flow of water. The water supply issuing from the nozzle shall be of sufficient volume and height so that persons

using the fountain need not come in direct contact with the nozzle or orifice.

(n) *Water softeners.* Water softeners shall conform to WQA S-100.

(5) **FAUCETS AND FIXTURE FITTINGS.** (a) *Approval.* Faucets and fixture fittings shall conform to ANSI A112.18.1M.

(b) *Hose spray.* Sink faucets with flexible hose and spray assembly shall conform to ASSE 1025.

(c) *Hand showers.* Hand held showers shall conform to ASSE 1014.

History: Cr. Register, February, 1985, No. 350, eff. 3-1-85.

**ILHR 84.30 Plumbing materials.** (1) **SANITARY DRAIN AND VENT SYSTEMS.** Sanitary drain systems and vent systems shall be of such material and workmanship as set forth in this subsection.

(a) *Above ground drain and vent pipe.* Except as provided in s. ILHR 82.33 (2), drain pipe and vent pipe to be installed above ground shall conform to one of the standards listed in Table 84.30-1.

**Table 84.30-1**  
**ABOVE GROUND DRAIN AND VENT PIPE**

Material	Standard
Acrylonitrile butadiene styrene (ABS) plastic pipe <sup>a</sup>	ASTM D2661; ASTM F628
Brass pipe	ASTM B43
Cast iron pipe	ASTM A74; CISPI 301
Copper pipe	ASTM B42; ASTM B302
Copper tubing; Types K, L, M, and DWV	ASTM B75; ASTM B88; ASTM B251; ASTM B306
Galvanized steel pipe	ASTM A53; ASTM A120
Lead pipe	FS-WW-P-325B
Polyvinyl chloride (PVC) plastic pipe <sup>a</sup>	ASTM D2665
Synthetic rubber hose <sup>b</sup>	AHAM DW-1

Note a: Plastic pipe used for drain or vent stacks shall not be installed more than 45 feet below the top of the vent terminal serving the stack.

Note b: The installation of synthetic rubber hose is limited in use to indirect waste piping or local waste piping from dishwashers in accordance with s. ILHR 82.33 (9) (d).

(b) *Underground drain and vent pipe.* Drain pipe and vent pipe to be installed underground shall conform to one of the standards listed in Table 84.30-2.

**Table 84.30-2**  
**UNDERGROUND DRAIN AND VENT PIPE**

Material	Standard
Acrylonitrile butadiene styrene (ABS) plastic pipe	ASTM D2661; ASTM F628
Cast iron pipe	ASTM A74; CISPI 301
Copper tubing; Types K and L	ASTM B75; ASTM B88; ASTM B251
Polyvinyl chloride (PVC) plastic pipe	ASTM D2665
Vitrified clay pipe	ASTM C4; ASTM C700

(c) *Sanitary building sewer pipe.* Sanitary building sewer pipe shall conform to one of the standards listed in Table 84.30-3.

1. **Building Sewer Pipe in Trench with Water Service.** When a building sewer is installed in the same trench as the water service in accordance Register, February, 1985, No. 350

with s. ILHR 82.40 (2) (d) 1., the building sewer pipe shall conform to one of the standards for acrylonitrile butadiene styrene plastic pipe, cast iron pipe, copper tube, or polyvinyl chloride plastic pipe listed in Table 84.30-3.

2. Building Sewer Pipe on Filled Ground. Where a building sewer is installed on filled or unstable ground, the building sewer pipe shall conform to one of the standards for acrylonitrile butadiene styrene plastic pipe, cast iron pipe, copper tube, or polyvinyl chloride plastic pipe listed in Table 84.30-3.

**Table 84.30-3**  
**SANITARY BUILDING SEWER PIPE**

Material	Standard
Acrylonitrile butadiene styrene (ABS) plastic pipe <sup>a</sup>	ASTM D2661; ASTM D2751; ASTM F628
Acrylonitrile butadiene styrene composite pipe	ASTM D2680
Asbestos cement pipe	ASTM C428
Cast iron pipe	ASTM A74; CISPI 301
Concrete pipe	ASTM C14; ASTM C76
Copper tubing; Types K and L	ASTM B75; ASTM B88; ASTM B251
Polyvinyl chloride (PVC) plastic pipe <sup>a</sup>	ASTM D2665; ASTM D3033; ASTM D3034
Vitrified clay pipe	ASTM C4; ASTM C700

Note a: Thermoplastic sewer pipe shall be installed in accordance with ASTM D2321.

(d) *Chemical drain and vent pipe.* Drain systems and vent systems for chemical wastes shall be of approved corrosion resistant material. The manufacturer of the pipe shall indicate to the department the material's suitability for the concentrations of chemicals involved.

(e) *Catch basins, interceptors and sumps.* Catch basins, interceptors and sumps shall be constructed in a watertight manner of precast reinforced concrete, reinforced monolithic concrete, brick or block, cast iron, coated 12 gauge steel, vitrified clay, fiberglass, or other approved materials.

(f) *Manholes.* Manholes shall be constructed in a watertight manner of precast reinforced concrete, reinforced monolithic concrete, brick or block, fiberglass or other approved materials. Fiberglass manholes may be approved for use in high traffic areas provided the top section of the manhole is not made of fiberglass.

(2) **STORM AND CLEAR WATER DRAIN SYSTEMS.** Storm and clear water drain systems shall be of such material and workmanship as set forth in this subsection.

(a) *Above ground drain and vent pipe.* Drain and vent pipe installed above ground and inside a building shall conform to one of the standards listed in Table 84.30-1, except black iron or steel pipe conforming to ASTM A53 or ASTM A120 may be used for storm water conductors. Black iron and steel conductors shall not be embedded in concrete or masonry.

(b) *Underground drain and vent pipe.* Drain and vent pipe to be installed underground shall conform to one of the standards listed in Table 84.30-2.

ILHR 84

(c) *Storm building sewer pipe.* Storm building sewer pipe shall conform to one of the standards listed in Table 84.30-4 and the provisions of sub. (1) (c) 2.

(d) *Subsoil drain pipe.* Subsoil drains shall be open jointed, horizontally split, or perforated pipe conforming to one of the standards listed in Table 84.30-5.

(e) *Roof drains.* Roof drains shall conform to ANSI A112.21.2.

(f) *Area drain inlets.* Area drain inlets shall be constructed in a water-tight manner of precast concrete, reinforced monolithic concrete, brick or block, cast iron, coated 12 gauge steel, vitrified clay, fiberglass or other approved materials.

**Table 84.30-4**  
**STORM BUILDING SEWER PIPE**

Material	Standard
Acrylonitrile butadiene styrene (ABS) plastic pipe <sup>a</sup>	ASTM D2661; ASTM D2751; ASTM F628
Acrylonitrile butadiene styrene composite pipe	ASTM 2680
Asbestos cement pipe	ASTM C428
Cast iron pipe	ASTM A74; CISPI 301
Concrete pipe	ASTM C14; ASTM C76
Copper tubing; Types K and L	ASTM B75; ASTM B88; ASTM B251
Corrugated steel pipe <sup>b</sup>	FS-WW-P-405a
Polyvinyl chloride (PVC) plastic pipe <sup>a</sup>	ASTM D2665; ASTM D3033; ASTM D3034
Vitrified clay pipe	ASTM C4; ASTM C700

Note a: Thermoplastic sewer pipe shall be installed in accordance with ASTM D2321.

Note b: Corrugated steel pipe may be used for storm building sewers subject to the following conditions:

1. The pipe shall be sized according to ch. ILHR 82 with adjustments considered to allow for flow characteristics and configuration of the pipe; and

2. The corrugated steel building storm sewer shall not be installed closer than 10 feet from a building's exterior wall or foundation.

**Table 84.30-5**  
**SUBSOIL DRAIN PIPE**

Material	Standard
Asbestos cement pipe	ASTM C508
Cast iron pipe	ASTM A74; CISPI 301
Polyethylene (PE) plastic pipe	ASTM F405
Polyvinyl chloride (PVC) plastic pipe	ASTM D2729 (Perforated only)
Styrene rubber (SR) pipe	ASTM D3298
Vitrified clay pipe	ASTM C4; ASTM C700

(3) **WATER SERVICE AND DISTRIBUTION SYSTEMS.** Water service and distribution systems shall be of such material and workmanship as set forth in this subsection.

(a) *Water service pipe.* 1. When selecting the material and size for water service supply pipe, tube, or fittings, due consideration shall be given to the action of the water on the interior of the pipe and of the soil, fill or other materials on the exterior of the pipe.

2. Water service pipe shall conform to one of the standards listed in Table 84.30-6. Water service pipe and tubing shall have a minimum working pressure of 160 pounds per square inch gage at 73.4 degrees F. Plastic water service piping shall not extend more than 5 feet horizontally from the inside of the foundation.

**Table 84.30-6**  
**WATER SERVICE PIPE**

Material	Standard
Acrylonitrile butadiene styrene (ABS) plastic pipe <sup>a</sup>	ASTM D1527; ASTM D2282
Asbestos cement pipe	ASTM C296
Brass pipe	ASTM B43
Cast iron pipe	ASTM A377; AWWA C151/A21.51
Copper or copper alloy pipe and tubing; Types K and L	ASTM B42; ASTM B302; ASTM B75; ASTM B88; ASTM B251
Ductile iron pipe	AWWA C151/A21.51
Galvanized steel pipe	ASTM A53; ASTM A120
Polybutylene (PB) plastic pipe and tubing <sup>a</sup>	ASTM D2662; ASTM D2666; ASTM D3309
Polyethylene (PE) plastic pipe and tubing <sup>a</sup>	ASTM D2239; ASTM D2737
Polyvinyl chloride (PVC) plastic pipe <sup>a</sup>	ASTM D1785; ASTM D2241; ASTM D2672

Note a: Plastic water service systems shall be installed in accordance with ASTM D2774.

(b) *Water distribution pipe.* 1. Water distribution pipe to be installed underground shall conform to one of the standards for brass, cast iron, copper or copper alloy, ductile iron or galvanized steel listed in Table 84.30-6.

2. Water distribution pipe to be installed above ground shall conform to one of the standards listed in Table 84.30-7.

3. All hot water distribution pipe and tubing shall have a minimum pressure rating of 80 pounds per square inch gage at 180 degrees F.

(c) *Existing water service.* Existing metallic water service piping or water distribution piping used for electrical grounding shall not be replaced with nonmetallic pipe or tubing until other approved electrical grounding means are provided.

**Table 84.30-7**  
**WATER DISTRIBUTION PIPE**

Material	Standard
Brass pipe	ASTM B43
Copper pipe-rigid	ASTM B42; ASTM B302
Copper tubing-rigid; Types K, L, and M	ASTM B75; ASTM B88; ASTM B251
Galvanized steel pipe	ASTM A53; ASTM A120

(4) **PIPE FITTINGS AND VALVES.** (a) *Fittings.* Pipe fittings shall conform to the pipe material standards listed in this chapter or one of the standards listed in Table 84.30-8. Threaded drain pipe fittings shall be of the recessed drainage type.

(b) *Water supply valves.* All valves for water supply systems shall be of an approved type in accordance with s. ILHR 82.40, and shall be compatible with the type of piping material used in accordance with s. ILHR 84.40.



**Table 84.30-8**  
**PIPE FITTINGS**

Material	Standard
Cast iron	ANSI B16.4; ANSI B16.12
Copper or copper alloy	ANSI B16.15; ANSI B16.18; ANSI B16.22; ANSI B16.23; ANSI B16.26; ANSI B16.29; ANSI B16.32; ANSI B16.43
Gray iron and ductile iron	AWWA C110/A21.10
Malleable iron	ANSI B16.3
Plastic	ASTM D2464; ASTM D2465; ASTM D2466; ASTM D2467; ASTM D2468; ASTM D2469; ASTM 2609; ASTM D3311; ASTM F409
Steel	ANSI B16.9; ANSI B16.11; ANSI B16.28

(c) *Special fittings and valves.* 1. Water hammer arrestors shall conform to ANSI A112.26.1.

2. Relief valves and automatic gas shutoff devices for hot water supply systems shall conform to ANSI Z21.22.

3. Water pressure reducing valves for domestic supply systems shall conform to ASSE 1003.

4. Water heater drain valves shall conform to ASSE 1005.

5. Hose connection vacuum breakers shall conform to ASSE 1011.

6. Backflow preventers with intermediate atmospheric vents shall conform to ASSE 1012.

7. Reduced pressure principle backflow preventers shall conform to ASSE 1013.

8. Backwater valves shall conform to ANSI A112.14.1.

(5) **SPECIAL MATERIALS.** (a) *Sheet lead.* Sheet lead for the following uses shall weigh not less than indicated in subs. 1. to 4. and shall conform to FS QQ-L-210f-2:

1. General use, 4 pounds per square foot;

2. Safe pans, 4 pounds per square foot;

3. Flashings for vent pipes, 3 pounds per square foot; and

4. Prefabricated flashings for vent pipes, 2½ pounds per square foot.

(b) *Lead bends and traps.* The walls of lead bends and traps shall be at least ⅜ inch thick, and shall conform to FS WW-P-325B.

(c) *Traps and tail piece fittings.* Copper or tubular brass traps and tail piece fittings shall be at least 20 gage material, and shall conform to the requirements of ANSI A112.18.1M.

(d) *Sheet copper.* Sheet copper for the following uses shall weigh not less than indicated in subs. 1. to 4. and shall conform to ASTM B152:

1. General use, 12 oz. per square foot;

2. Flashing for vent pipes, 8 oz. per square foot; and

3. Flush tank linings, 10 oz. per square foot.

(e) *Caulking ferrules.* Caulking ferrules shall be of red brass and shall be in accordance with Table 84.30-9.

**Table 84.30-9**  
**CAULKING FERRULE SPECIFICATIONS**

Pipe Sizes Inches	Inside Diameter Inches	Length Inches	Minimum Weight Each
2	2¾	4½	1 lb. 0 oz.
3	3¾	4½	1 lb. 12 oz.
4	4¾	4½	2 lb. 8 oz.

(f) *Soldering bushings.* Soldering bushings shall be of red brass in accordance with Table 84.30-10.

**Table 84.30-10**  
**SOLDERING BUSHING SPECIFICATIONS**

Pipe Sizes Inches	Minimum Weight Each
1¼	6 oz.
1½	8 oz.
2	14 oz.
2½	1 lb. 6 oz.
3	2 lb. 0 oz.
4	3 lb. 8 oz.

(g) *Closest flanges.* 1. Closet flanges for water closets or similar fixtures shall be not less than ⅝ inch thick for brass; ¼ inch thick for plastic; and shall not be less than 2 inch caulking depth for cast iron or galvanized malleable iron.

2. Closet flanges of hard lead shall weigh not less than 1 lb. 9 oz. and shall be composed of lead alloy with not less than 7.75 percent antimony by weight.

3. Flanges shall be soldered to lead bends, or shall be caulked, soldered or threaded into other metal piping. Flanges shall be solvent cemented to plastic piping.

4. Water closet screws and bolts shall be brass or other approved materials.

(h) *Cleanout plugs.* Cleanout plugs shall be of brass or plastic. Brass cleanout plugs shall be used with metallic piping only, and shall conform to ASTM A74. Plastic cleanout plugs shall conform to the requirements of sub. (4) (a). Plugs shall have raised square, countersunk square or slotted heads. Countersunk heads shall be used where raised heads may be a hazard.

(i) *Flush pipes and fittings.* Flush pipes and fittings shall be of nonferrous material and shall conform to ANSI A112.19.5.

(j) *Safing materials.* Safing materials made from chlorinated polyethylene shall conform to ASTM D4068.

(6) **FIXTURE MATERIALS.** (a) *Quality of fixtures.* Plumbing fixtures shall be constructed from approved materials, have smooth, impervious surfaces, be free from defects and concealed fouling surfaces and shall conform to standards cited in this chapter.

(b) *Materials for special use fixtures.* Materials for special use fixtures not otherwise covered in this chapter may be stainless steel, soapstone or

chemical stoneware, plastic, or may be lined with lead, copper base alloy, nickel copper alloy, corrosion resisting steel, or other materials especially suited to the use for which the fixture is intended.

History: Cr. Register, February, 1985, No. 350, eff. 3-1-85.

**ILHR 84.40 Joints and connections.** (1) **GENERAL.** (a) *Tightness.* Joints and connections in the plumbing system shall be watertight and gastight for the pressure required by test or the system design, whichever is greater, with the exception of perforated or open joint piping which is installed for the purpose of collecting and conveying groundwater.

Note: The testing requirements for tightness are in s. ILHR 82.21.

(b) *Approval.* All joints and connections shall be of an approved type in accordance with this section.

(c) *Preparation of pipe ends.* All pipe shall be cut square, reamed, chamfered and free of all burrs and obstructions. Pipe ends shall have full bore openings and shall not be undercut.

(2) **ABS PLASTIC PIPE.** Joints between acrylonitrile butadiene styrene plastic pipe or fittings shall be installed in accordance with pars. (a) to (c).

(a) *Mechanical joints.* Mechanical joints may be installed where approved by the department and shall be installed in accordance with the department's approval and the manufacturer's instructions.

1. Drain and vent systems. Mechanical push-on joints for drain and vent systems shall conform to ASTM D3212.

2. Water supply systems. Mechanical push-on joints and mechanical compression type joints for water supply systems shall conform to ASTM D3139.

(b) *Solvent cemented joints.* Solvent cemented joints shall be made in accordance with ASTM D2235 and its appendix, ASTM D2661 or ASTM F628.

1. Joint surfaces shall be clean and free of moisture.

2. Solvent cement conforming to ASTM D2235 shall be applied to all joints, surfaces and the joint shall be made while the cement is wet.

3. Solvent cement shall be handled in accordance with ASTM F402.

(c) *Threaded joints.* Threaded joints shall only be used on pipes of schedule 80 or heavier. Threaded joints shall conform to ANSI B2.1. The pipe shall be threaded with dies specifically designed for plastic pipe. Thread lubricant or tape approved for such use shall be applied to the male threads only.

(3) **ASBESTOS CEMENT PIPE.** Joints between asbestos cement pipe or fittings shall be made with a sleeve coupling of the same composition as the pipe, sealed with an elastomeric ring conforming to ASTM D1869.

(4) **BLACK IRON PIPE.** Joints between black iron pipe or fittings shall be in accordance with pars. (a) to (d).

(a) *Threaded joints.* Threaded joints shall conform to ANSI B2.1. Pipe joint compound or tape shall be used on the male threads only.

(b) *Mechanical joints.* Mechanical joints may be installed where approved by the department and shall be installed in accordance with the department's approval and the manufacturer's instructions.

(c) *Caulked joints.* Caulked joints for hub and spigot piping and fittings shall be firmly packed with oakum or hemp. Molten lead shall be poured in one operation not less than one inch deep and not to extend more than  $\frac{1}{8}$  inch below the rim of the pipe, and caulked tight. Paint, varnish or other coatings shall not be permitted on the joining material until after the joint has been tested and approved.

(d) *Welded joints.* Joints between black iron pipe or fittings may be welded.

(5) **BRASS PIPE.** Joints between brass pipe or fittings shall be in accordance with the provisions of pars. (a) to (c).

(a) *Brazed joints.* All joint surfaces to be brazed shall be cleaned. A flux shall be applied to all joint surfaces when required. Brazing filler metal conforming to AWS A5.8 or other approved material shall be applied and the joint shall be made by heating to the proper temperature. The joining of water supply piping shall be made by lead-free filler metals and fluxes. Lead-free shall mean a chemical composition equal to or less than 0.2% of lead.

(b) *Mechanical joints.* Mechanical joints may be installed where approved by the department and shall be installed in accordance with the department approval and the manufacturer's instructions. Mechanical push-on joints and mechanical compression type joints for supply systems shall conform to ASTM D3139.

(c) *Threaded joints.* Threaded joints shall conform to ANSI B2.1. Pipe joint compound or tape shall be used on the male threads only.

(6) **CAST IRON PIPE.** Joints between cast iron pipe or fittings shall be installed in accordance with pars. (a) and (b).

(a) *Caulked joints.* 1. Drain and vent systems. Caulked joints for hub and spigot pipe of drain and vent systems shall be firmly packed with oakum or hemp. Molten lead shall be poured in one operation not less than one inch deep and not to extend more than  $\frac{1}{8}$  inch below the rim of the pipe, and caulked tight. Paint, varnish or other coatings shall not be permitted on the joining material until after the joint has been tested and approved.

2. Water supply systems. Joints for bell and spigot pipe of water systems shall be firmly packed with clean asbestos rope or treated paper rope. Molten lead shall be poured in one operation to a depth of  $2\frac{1}{2}$  inches.

(b) *Mechanical joints.* 1. Drain and vent systems. a. Mechanical push-on joints for drain and vent systems shall have gaskets which conform to ASTM C564.

b. Mechanical sleeve joints for drain and vent systems shall have an elastomeric sealing sleeve conforming to ASTM C564 or CISPI 310. Where a stainless steel band assembly is used, the band assembly shall conform to CISPI 310. Mechanical joints shall be installed in accordance with the department's approval and with manufacturer's instructions.

2. Water supply systems. Mechanical push-on joints and mechanical compression type joints for water supply systems shall conform to AWWA C111/A21.11.

(7) **CONCRETE PIPE.** Joints between concrete pipe or fittings shall be made by use of an elastomeric seal conforming to ASTM C443.

(8) **COPPER OR COPPER ALLOY PIPE AND TUBING.** Joints between copper or copper alloy pipe, tubing or fittings shall be installed in accordance with pars. (a) to (d).

(a) *Brazed joints.* All joint surfaces to be brazed shall be cleaned. A flux shall be applied to all joint surfaces when required. Brazing filler metal conforming to AWS A5.8 or other approved material shall be applied and the joint shall be made by heating to the proper temperature. The joining of water supply piping shall be made by lead-free filler metals and fluxes. Lead-free shall mean a chemical composition equal to or less than 0.2% of lead.

(b) *Flared joints.* Flared joints may be used only on tubing for water supply systems and shall be made by the use of a tool designed for that operation.

(c) *Mechanical joints.* Mechanical joints may be installed where approved by the department and shall be installed in accordance with the department's approval and the manufacturer's instructions. Mechanical push-on joints and mechanical compression type joints for water supply systems shall conform to ASTM D3139.

(d) *Soldered joints.* All joint surfaces to be soldered shall be cleaned. A flux shall be applied to all joint surfaces. Solder conforming to ASTM B32 or other approved material shall be applied. The joining of water supply piping shall be made with lead-free solders and fluxes. The joint shall be made by heating to the proper temperature. Lead-free shall mean a chemical composition equal to or less than 0.2% of lead.

(9) **DUCTILE IRON PIPE.** Mechanical push-on joints and mechanical compression type joints for water supply systems shall conform to AWWA C111/A21.11.

(10) **GALVANIZED STEEL PIPE.** Joints between galvanized steel pipe or fittings or between galvanized steel pipe and cast iron fittings shall be installed in accordance with pars. (a) to (c).

(a) *Threaded joints.* Threaded joints shall conform to ANSI B2.1. Pipe joint compound or tape shall be used on the male threads only.

(b) *Mechanical joints.* Mechanical joints may be installed where approved by the department and shall be installed in accordance with the department's approval and the manufacturer's instructions.

(c) *Caulked joints.* Caulked joints shall only be used for drain or vent piping. Caulked joints for hub and spigot piping and fittings shall be firmly packed with oakum or hemp. Molten lead shall be poured in one operation not less than one inch deep and not to extend more than  $\frac{1}{8}$  inch below the rim of the pipe, and caulked tight. Paint, varnish or other coatings shall not be permitted on the joining material until after the joint has been tested and approved.

1. Caulked joints for drain piping shall be used only for piping in a vertical position.

2. Caulked joints for vent piping may be used for piping in a vertical or horizontal position.

(11) **LEAD PIPE.** Joints between lead pipe or fittings shall be installed in accordance with pars. (a) and (b).

(a) *Burned joints.* Burned joints shall be uniformly fused together into one continuous piece. The thickness of the joint shall be at least as thick as the lead being joined. The filler metal shall be of the same material as the pipe.

(b) *Wiped joints.* Wiped joints shall be full wiped, having an exposed surface on each side of the joint not less than  $\frac{3}{8}$  inch. The joint shall be at least  $\frac{3}{8}$  inch thick at the thickest point.

(12) **PB PLASTIC PIPE AND TUBING.** Joints between polybutylene plastic pipe and tubing or fittings shall be installed in accordance with pars. (a) to (c).

(a) *Flared joints.* Flared joints shall be made by use of a tool designed for that operation. Flared joints shall be made in accordance with ASTM D3140.

(b) *Heat fusion joints.* Heat fusion joints shall be made in accordance with ASTM D2657 and ASTM D3309. Heat fusion joints shall be of the socket fusion type.

1. Joint surfaces to be fused shall be clean and free of moisture.

2. All joint surfaces shall be heated to melt temperature and joined.

3. The joint shall be undisturbed until cool.

(c) *Mechanical joints.* Mechanical joints may be installed where approved by the department and shall be installed in accordance with the department's approval and the manufacturer's instructions. Mechanical push-on joints and mechanical compression type joints shall conform to ASTM D3139.

(13) **PE PLASTIC PIPE AND TUBING.** Joints between polyethylene plastic pipe, tubing or fittings shall be in accordance with pars. (a) to (c).

(a) *Flared joints.* Flared joints shall be made by use of a tool designed for that operation. Flared joints shall be made in accordance with ASTM D3140.

(b) *Heat fusion joints.* Heat fusion joints shall be made in accordance with ASTM D2657. Heat fusion joints shall be of the socket fusion type.

1. Joint surfaces to be fused shall be clean and free of moisture.

2. All joint surfaces shall be heated to melt temperature and joined.

3. The joint shall be undisturbed until cool.

(c) *Mechanical joints.* Mechanical joints may be installed where approved by the department and shall be installed in accordance with the department's approval and the manufacturer's instructions. Mechanical

push-on joints and mechanical compression type joints shall conform to ASTM D3139.

(14) **PVC PLASTIC PIPE.** Joints between polyvinyl chloride plastic pipe or fittings shall be installed in accordance with pars. (a) to (c).

(a) *Mechanical joints.* Mechanical joints may be installed where approved by the department and shall be installed in accordance with the department's approval and the manufacturer's instructions.

1. Drain and vent systems. Mechanical push-on joints for drain and vent systems shall conform to ASTM D3212.

2. Water supply systems. Mechanical push-on joints and mechanical compression type joints for water supply systems shall conform to ASTM D3139.

(b) *Solvent cemented joints.* Solvent cemented joints shall be made in accordance with ASTM D2855.

1. Joint surfaces shall be clean and free of moisture. A primer conforming to ASTM F656 shall be applied to all joint surfaces.

2. Solvent cement conforming to ASTM D2564 shall be applied to all joint surfaces and the joint shall be made while the cement is wet.

3. Solvent cement shall be handled in accordance with ASTM F402.

(c) *Threaded joints.* Threaded joints shall only be used on pipes of schedule 80 or heavier. Threaded joints shall conform to ANSI B2.1. The pipe shall be threaded with dies specifically designed for plastic pipe. Thread lubricant or tape approved for such use shall be applied to the male threads only.

(15) **STEEL PIPE.** Joints between nongalvanized steel pipe or fittings shall be in accordance with pars. (a) to (d).

(a) *Threaded joints.* Threaded joints shall conform to ANSI B2.1. Pipe joint compound or tape shall be used on the male threads only.

(b) *Mechanical joints.* Mechanical joints may be installed where approved by the department and shall be installed in accordance with the department's approval and the manufacturer's instructions.

(c) *Caulked joints.* Caulked joints shall only be used for drain or vent piping. Caulked joints for hub and spigot piping and fittings shall be firmly packed with oakum or hemp. Molten lead shall be poured in one operation not less than one inch deep and not to extend more than  $\frac{1}{8}$  inch below the rim of the pipe, and caulked tight. Paint, varnish or other coatings shall not be permitted on the joining material until after the joint has been tested and approved.

1. Caulked joints for drain piping shall be used only in a vertical position.

2. Caulked joints for vent piping may be used for piping in a vertical or horizontal position.

(d) *Welded joints.* Joints between steel pipe or fittings may be welded.

(16) **VETRIFIED CLAY PIPE.** Joints between vitrified clay pipe or fittings shall be made by use of an elastomeric seal conforming to ASTM C425.

(17) **JOINTS BETWEEN PIPE AND FITTINGS OF DIFFERENT MATERIALS.** (a) *General.* Joints between different piping materials shall be made with a mechanical joint of the compression or mechanical sealing type, unless otherwise permitted in this chapter.

1. Connectors of adaptors shall have an elastomeric seal conforming to ASTM C425, ASTM C443, ASTM C564, ASTM D1869 or ASTM F477.

2. Joints shall be installed in accordance with the department approval and the manufacturer's instructions.

3. Joints and connections between different piping materials in the water supply system shall be accessible.

(b) *Copper or copper alloy pipe to cast iron hub pipe.* Joints between copper or copper alloy pipe and cast iron hub pipe shall be made by use of a brass ferrule. The copper or copper alloy tubing shall be properly soldered to the ferrule, and the ferrule shall be joined to the cast iron hub by a caulked joint or mechanical compression joint. If the tubing and ferrule are part of a water supply system, a lead-free solder and, when required, a lead-free flux shall be used to make the joint. Lead-free shall mean a chemical composition equal to or less than 0.2% of lead.

(c) *Copper or copper alloy pipe to galvanized steel pipe.* Joints between copper or copper alloy pipe and galvanized steel pipe shall be made by the use of a brass converter fitting or dielectric fitting. The copper tubing shall be properly soldered to the fitting, and the fitting shall be screwed to the threaded pipe. If the tubing and fitting are part of a water supply system, a lead-free solder and, when required, a lead-free flux shall be used to make the joint. Lead-free shall mean a chemical composition equal to or less than 0.2% of lead.

(d) *Cast iron pipe to steel, black iron or brass pipe.* Joints between cast iron and galvanized or nongalvanized steel, black iron or brass pipe shall be made by means of either caulked or threaded joints, or by the use of an approved adapter fitting.

(e) *Plastic pipe or tubing to other piping material.* Joints between different grades of plastic pipe, or between plastic pipe and other piping material shall be made by the use of a threaded fitting or an approved adapter fitting. Joints between plastic pipe and cast iron pipe shall be made by a caulked joint or an approved mechanical compression joint.

(f) *Lead pipe to other piping material.* Joints between lead pipe and other piping material shall be made by wiped joint to a caulking ferrule, soldering nipple, bushing or by use of an approved adapter fitting.

(18) **PROHIBITED JOINTS AND CONNECTIONS.** Unless otherwise approved by the department, the types of joints and connections specified in pars. (a) to (e) shall be prohibited:

(a) Cement or concrete joints;

(b) Mastic or hot pour bituminous joints;

(c) The use of fittings not approved for the specific type of installation;

(d) Elastomeric rolling 0-rings between different diameter pipe; and



(e) Solvent cement joints between different types of plastic pipe.

(19) CONNECTION OF FIXTURES. (a) *Flanged drain connections*. 1. Floor outlet fixtures. Connections between the drain system and floor outlet, flanged fixtures with integral traps shall be made by the use of a closet flange. The flange shall be joined to the drain and fastened to the structure. The fixture shall be fastened with brass bolts or other approved materials to the closet flange and the joint shall be sealed with an approved elastomeric gasket or setting compound conforming to FS TT-P-1536a.

2. Floor mounted, wall outlet fixtures. Connections between the drain system and floor mounted, wall outlet, flanged fixtures with integral traps shall be made as specified for floor outlet fixtures in subd. 1. or by the use of an approved carrier type fitting and gasket or seal.

3. Wall mounted, wall outlet fixtures. Connections between the drainage system and wall mounted, wall outlet, flanged fixtures with integral traps shall be made by the use of an approved carrier type fitting and gasket or seal.

(b) *Drain slip joints*. 1. Slip joints for drain piping and fittings shall be made by the use of an approved plastic or metal slip joint gasket. Slip joints may be used on the trap inlet, trap outlet or within the trap seal.

2. An access panel, utility space or other convenient access shall be provided to fixtures with concealed slip joint connections so as to make the connection accessible for inspection and repair.

(c) *Ground joints*. Brass or copper ground faced ferrule type connections which allow adjustment of tubing but provide a rigid joint when made up may be used on a fixture water supply and on the discharge side of a brass tube trap, but may not be concealed.

(d) *Ground faced unions*. Ground faced unions of drainage pattern may be used in waste piping but may not be concealed.

(20) EXPANSION JOINTS. Expansion joint fittings shall be of an approved type for the piping material being joined.

History: Cr. Register, February, 1985, No. 350, eff. 3-1-85.

**ILHR 84.50 Alternate, experimental materials and engineered plumbing systems.** (1) ALTERNATE AND EXPERIMENTAL MATERIALS. The provisions of chs. ILHR 82 and 84 are not intended to prevent the use of any alternate plumbing material or alternate method of plumbing installation provided the alternative has been first approved by the department. The department shall review and make a determination on an application for approval of alternate and experimental materials or methods within 3 months of receipt of all information required to complete the review.

(c) An alternate material submitted for approval shall be at least equivalent to standards specified in this chapter for the intended use. Alternate methods of installation submitted for approval shall conform to acceptable nationally recognized plumbing standards.

1. Tests for alternate materials and methods of installation shall be made in accordance with standards or procedures specified by the department.

Register, February, 1985, No. 350

2. The department may require tests to be made or repeated if, at any time, there is reason to believe that an alternate material no longer conforms to the requirements on which its approval was based.

(2) **ENGINEERED PLUMBING SYSTEMS.** The provisions of this subsection shall control the design, installation and supervision of the engineered plumbing systems.

(a) *Plans and specifications.* Plans and specifications for all engineered plumbing systems shall be submitted in accordance with s. ILHR 82.20.

1. The plans, specifications and all pertinent data shall indicate the nature and extent of the proposed system before an approval is granted.

2. Plans, specifications and data shall include complete plans indicating the fixture arrangements and the locations of drain stacks, vertical drain pipes and horizontal drains. Plans shall show the complete drain

**Next page is numbered 397.**

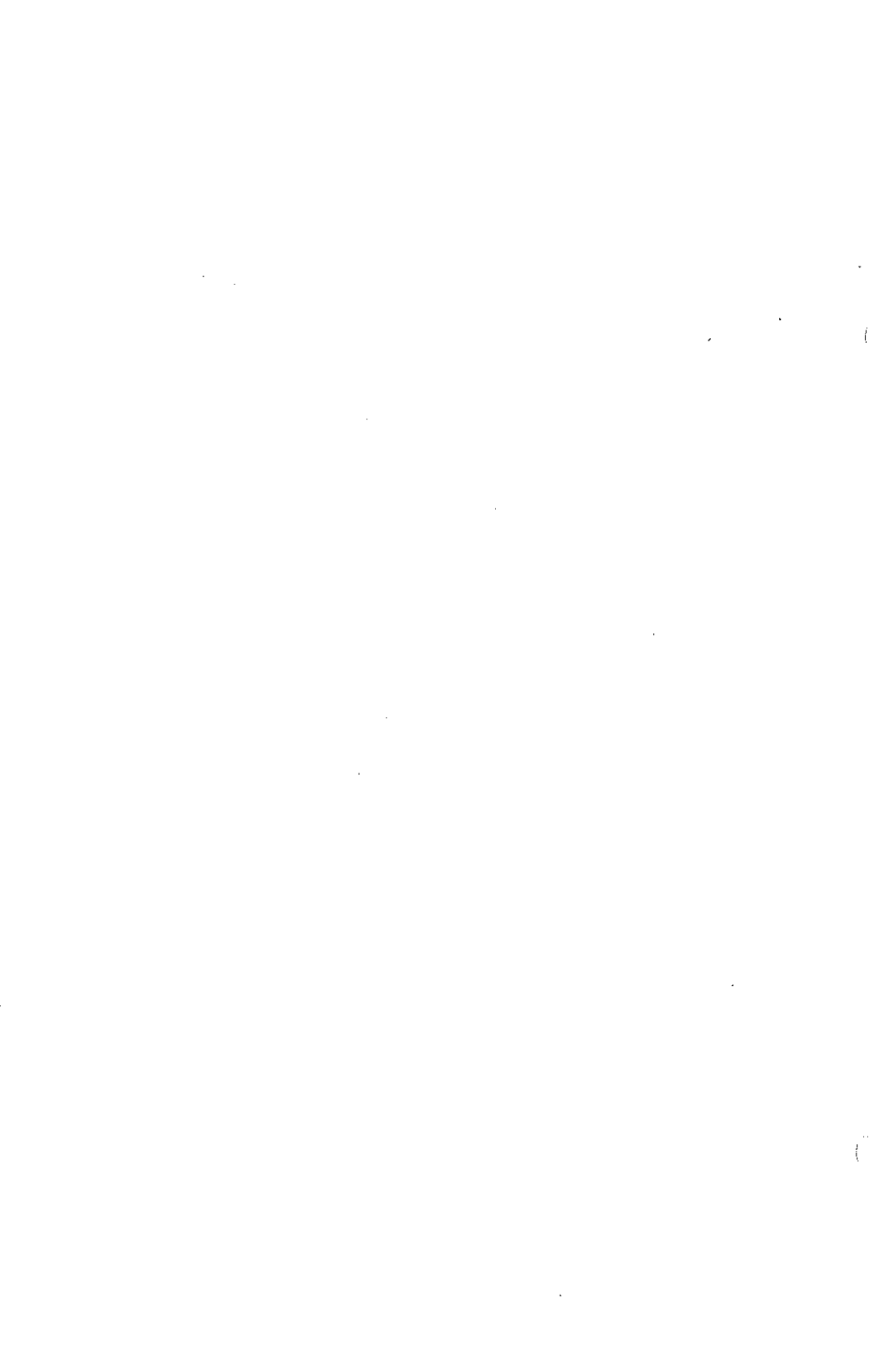

and vent systems, showing all piping in proper sequence, identifying the load value of each in drainage fixture units, the direction of flow, pipe size, grade of horizontal piping, support, and the supply fixture unit load for the water system and any branch supplies which serve more than one plumbing fixture, appliance or hose outlet.

4. When requested, additional details and data pertaining to the design, installations and materials of an engineered plumbing system shall be submitted to the department.

(b) *Inspections.* The registered architect, engineer, plumbing designer or master plumber responsible for the design of the engineered plumbing system shall provide on-site supervision of the installation.

1. Upon completion of the installation, the registered architect, engineer, plumbing designer or master plumber shall certify in writing to the department that the installation is in compliance with the approve plans, specifications and data.

2. The department may require periodic inspections of the system by the registered architect, engineer, plumbing designer or master plumber after the installation is completed to monitor the performance of the system.

Note: See Appendix for further explanatory material.

History: Cr. Register, February, 1985, No. 350, eff. 3-1-85.

**ILHR 84.60 Incorporation of standards by reference.** (1) **CONSENT.** Pursuant to s. 227.025, Stats., the attorney general and the revisor of statutes have consented to the incorporation by reference of the standards listed in sub. (4).

(2) **COPIES.** Copies of the adopted standards are on file in the offices of the department, the secretary of state and the revisor of statutes. Copies also may be purchased through the respective organizations.

(3) **INTERIM AMENDMENTS.** Interim amendments of the adopted standards shall have no effect in the state until such time as this section is correspondingly revised to reflect the changes.

(4) **ADOPTION OF STANDARDS.** The following standards are hereby incorporated by reference into this chapter.

History: Cr. Register, February, 1985, No. 350, eff. 3-1-85.

<b>AHAM</b>	Association of Home Appliance Manufacturers 20 North Wacker Drive Chicago, Illinois 60606
Standard Reference Number	Title
DW-1-82	Household Dishwashers
<b>ANSI</b>	American National Standards Institute, Inc. 1430 Broadway New York, New York 10018

Standard Reference Number	Title
A112.6.1M-79	Supports for Off-the-Floor Plumbing Fixtures for Public Use
A112.14.1-75	Backwater Valves
A112.18.1M-79	Finished and Rough Brass Plumbing Fixture Fittings
A112.19.1M-79	Enameled Cast Iron Plumbing Fixtures
A112.19.2M-82	Vitreous China Plumbing Fixtures
A112.19.3-76	Stainless Steel Plumbing Fixtures (Designed for Residential Use)
A112.19.4-77	Porcelain Enameled Formed Steel Plumbing Fixtures
A112.19.5-79	Trim for Water Closet Bowls, Tanks and Urinals (Dimensional Standards)
A112.21.1M-80	Floor Drains
A112.21.2-71	Roof Drains
A112.26.1-69(R1975)	Water Hammer Arrestors
B1.20.1-83	Pipe Threads, General Purpose (Inch)
B16.3-77	Malleable Iron Threaded Fittings, Class 150 and 300
B16.4-77	Cast Iron Threaded Fittings, Class 125 and 250
B16.9-78	Factory-Made Wrought Steel Butt welding Fittings
B16.11-80	Forged Steel Fittings, Socket-Welded and Threaded
B16.12-83	Cast Iron Threaded Drainage Fittings
B16.15-78	Cast Bronze Threaded Fittings, Class 125 and 250
B16.18-78	Cast Copper Alloy Solder-Joint Pressure Fittings
B16.22-80	Wrought Copper and Copper Alloy Solder Joint Pressure Fittings
B16.23-76	Cast Copper Alloy Solder Joint Drainage Fittings (DWV)
B16.26-83	Cast Copper Alloy Fittings for Flared Copper Tubes
B16.28-78	Wrought Steel Butt welding Short Radius Elbows and Returns
B16.29-80	Wrought Copper and Wrought Copper Alloy Solder Joint Drainage Fittings (DWV)
B16.32-79	Cast Copper Alloy Solder Joint Fittings for Solvent Drainage Systems
B16.43-82	Wrought Copper and Copper Alloy Solder Joint Fittings for Solvent Drainage Systems
Z21.22-79	Relief Valves and Automatic Gas Shutoff Devices for Hot Water Supply Systems
Z124.1-80	Plastic Bathtub Units
Z124.2-80	Plastic Shower Receptors and Shower Stalls
Z124.3-80	Plastic Lavatories
Z124.4-83	Plastic Water Closet Bowls and Tanks

Standard Reference Number	Title
ARI	Air-Conditioning and Refrigeration Institute 1815 North Fort Myer Drive Arlington, Virginia 22209

ARI-1010-82	Drinking-Fountains and Self-Contained, Mechanically-Refrigerated Drinking-Water Coolers
-------------	---

ASSE	American Society of Sanitary Engineering P.O. Box 9712 Bay Village, Ohio 44140
------	--

Standard Reference Number	Title
1001-82	Pipe Applied Atmospheric Type Vacuum Breakers
1002-79	Water Closet Flush Tank Ball Cocks
1003-81	Water Pressure Reducing Valves for Domestic Water Supply Systems
1004-67	Commercial Dishwashing Machines
1005-67	Water Heater Drain Valves, 3/4" Iron Pipe Size
1006-79	Household Dishwashers
1007-79	Home Laundry Equipment
1008-79	Household Food Waste Disposer Units
1009-70	Commercial Food Waste Disposer Units
1011-81	Hose Connection Vacuum Breakers
1012-78	Backflow Preventers with Intermediate Atmospheric Vent
1013-80	Reduced Pressure Principle Backflow Preventers, Including Appendix
1014-79	Handheld Showers
1018-78	Trap Seal Primer Valves
1025-78	Diverters for Plumbing Faucets with Hose Spray, Anti-Siphon Type, Residential Applications

ASTM	American Society for Testing and Materials 1916 Race Street Philadelphia, Pennsylvania 19103
------	--

Standard Reference Number	Title
A53-82	Pipe, Steel, Black and Hot-Dipped, Zinc-Coated Welded and Seamless, Specification for
A74-82	Cast Iron Soil Pipe and Fittings, Specification for
A120-82	Pipe, Steel, Black and Hot-Dipped Zinc-Coated (Galvanized) Welded and Seamless, for Ordinary Uses, Specification for
A377-79	Gray Iron and Ductile Iron Pressure Pipe, Specification for
B32-76	Solder Metal, Specification for

Standard Reference Number	Title
B42-83	Seamless Copper Pipe, Standard Sizes, Specification for
B43-80	Seamless Red Brass Pipe, Standard Sizes, Specification for
B75-81a	Seamless Copper Tube, Specification for
B88-83	Seamless Copper Water Tube, Specification for
B152-83	Copper Sheet, Strip, Plate, and Rolled Bar, Specification for
B251-81	General Requirements for Wrought Seamless Copper and Copper-Alloy Tube, Specification for
B302-81	Threadless Copper Pipe, Specification for
B306-81	Copper Drainage Tube (DWV), Specification for
C4-62(R1981)	Clay Drain Tile, Specification for
C14-82	Concrete Sewer, Storm Drain, and Culvert Pipe, Specification for
C76-83	Reinforced Concrete Culvert, Storm Drain, and Sewer Pipe, Specification for
C296-83	Asbestos-Cement Pressure Pipe, Specification for
C425-77(R1982)	Compression Joints for Vitrified Clay Pipe and Fittings, Specification for
C428-81	Asbestos-Cement Nonpressure Sewer Pipe, Specification for
C443-79	Joints for Circular Concrete Sewer and Culvert Pipe, Using Rubber Gaskets, Specification for
C508-83	Asbestos-Cement Underdrain Pipe, Specification for
C564-70(R1982)	Rubber Gaskets for Cast Iron Soil Pipe and Fittings, Specification for
C700-78a(R1983)	Vitrified Clay Pipe, Extra Strength, Standard Strength, and Perforated, Specification for
D1527-77(R1982)	Acrylonitrile-Butadiene-Styrene (ABS) Plastic Pipe, Schedules 40 and 80, Specification for
D1785-83	Poly (Vinyl Chloride) (PVC) Plastic Pipe, Schedules 40, 80 and 120, Specification for
D1869-78	Rubber Rings for Asbestos-Cement Pipe, Specification for
D2235-81	Solvent Cement for Acrylonitrile-Butadiene-Styrene (ABS) Plastic Pipe and Fittings, Specification for
D2239-83	Polyethylene (PE) Plastic Pipe (SIDR-PR) Based on Controlled Inside Diameter, Specification for
D2241-83	Poly (Vinyl Chloride) (PVC) Plastic Pipe (SDR-PR), Specification for
D2282-82	Acrylonitrile-Butadiene-Styrene (ABS) Plastic Pipe (SDR-PR), Specification for
D2321-74(R1980)	Underground Installation of Flexible Thermoplastic Sewer Pipe, Recommended Practice for

Standard Reference Number	Title
D2464-76	Threaded Poly (Vinyl Chloride) (PVC) Plastic Pipe Fittings, Schedule 80, Specification for
D2465-73(R1979)	Threaded Acrylonitrile-Butadiene-Styrene (ABS) Plastic Pipe Fittings, Schedule 80, Specification for
D2466-78	Poly (Vinyl Chloride) (PVC) Plastic Pipe Fittings, Schedule 40, Specification for
D2467-76a	Socket-Type Poly (Vinyl Chloride) (PVC) Plastic Pipe Fittings, Schedule 80, Specification for
D2468-80	Acrylonitrile-Butadiene-Styrene (ABS) Plastic Pipe Fittings, Schedule 40, Specification for
D2469-76	Socket-Type Acrylonitrile-Butadiene-Styrene (ABS) Plastic Pipe Fittings, Schedule 80, Specification for
D2564-80	Solvent Cements for Poly (Vinyl Chloride) (PVC) Plastic Pipe and Fittings, Specification for
D2609-74	Plastic Insert Fittings for Polyethylene (PE) Plastic Pipe, Specification for
D2657-79	Heat Joining of Polyolefin Pipe and Fittings, Specification for
D2661-82	Acrylonitrile-Butadiene-Styrene (ABS) Plastic Drain, Waste, and Vent Pipe and Fittings, Specification for
D2662-83	Polybutylene (PB) Plastic Pipe (SIDR-PR), Based on Controlled Inside Diameter, Specification for
D2665-82	Poly (Vinyl Chloride) (PVC) Plastic Drain, Waste, and Vent Pipe and Fittings, Specification for
D2666-83	Polybutylene (PB) Plastic Tubing, Specification for
D2672-80	Bell-End Poly (Vinyl Chloride) (PVC) Pipe, Specification for
D2680-80	Acrylonitrile-Butadiene-Styrene (ABS) Composite Sewer Piping
D2729-83	Poly (Vinyl Chloride) (PVC) Sewer Pipe and Fittings, Specification for
D2737-83	Polyethylene (PE) Plastic Tubing, Specification for
D2751-83a	Acrylonitrile-Butadiene-Styrene (ABS) Sewer Pipe and Fittings, Specification for
D2774-72(R1978)	Underground Installation of Thermoplastic Pressure Piping, Recommended Practice for
D2855-83	Making Solvent-Cemented Joints with Poly (Vinyl Chloride) (PVC) Pipe and Fittings, Recommended Practice for
D3033-83	Type PSP Poly (Vinyl Chloride) (PVC) Sewer Pipe and Fittings, Specification for
D3034-83	Type PSM Poly (Vinyl Chloride) (PVC) Sewer Pipe and Fittings, Specification for



Standard Reference Number	Title
D3139-77	Joints for Plastic Pressure Pipes Using Flexible Elastomeric Seals, Specification for
D3140-72(R1977)	Flaring Polyolefin Pipe and Tubing, Recommended Practice for
D3212-81	Joints for Drain and Sewer Plastic Pipes Using Flexible Elastomeric Seals, Specification for
D3298-81	Perforated Styrene-Rubber (SR) Plastic Drain Pipe, Specification for
D3309-81b	Polybutylene (PB) Plastic Hot-and Cold-Water Distribution Systems, Specification for
D3311-82	Drain, Waste, and Vent (DWV) Plastic Fittings Patterns, Specification for
F402-80	Safe Handling of Solvent Cements and Primers Used for Joining Thermoplastic Pipe and Fittings, Practice for
F405-82a	Corrugated Polyethylene (PE) Tubing and Fittings, Specification for
F409-81	Thermoplastic Accessible and Replaceable Plastic Tube and Tubular Fittings, Specification for
F477-76(R1981)	Elastomeric Seals (Gaskets) for Joining Plastic Pipe, Specification for
F628-81	Acrylonitrile-Butadiene-Styrene (ABS) Plastic Drain, Waste, and Vent Pipe Having a Foam Core, Specification for
F656-80	Primers for Use in Solvent Cement Joints of Poly (Vinyl Chloride) (PVC) Plastic Pipe and Fittings, Specification for

AWS American Welding Society  
2501 N.W. 7th Street  
Miami, Florida 33125

Standard Reference Number	Title
AWS A5.8-81	Brazing Filler Metal, Specification for
CISPI	Cast Iron Soil Pipe Institute 1499 Chain Bridge Road, Suite 203 McLean, Virginia 22101

Standard Reference Number	Title
301-82	Cast Iron Soil Pipe and Fittings for Hubless Cast Iron Systems for Drain, Waste or Vent, Sewer, Rainwater or Storm Drain Systems, Specification for
310-82	CISPI's Patented Joints for Use in Connection with Cast Iron Systems for Drain, Waste or Vent, Sewer, Rainwater or Storm Drain Systems, Specification for

<b>AWWA</b>	American Water Works Association Data Processing Department 6666 West Quincy Avenue Denver, Colorado 80235
<b>Standard Reference Number</b>	<b>Title</b>
C110/A21.10-82	American National Standard for Ductile- and Gray-Iron Iron Fittings, 3 in. through 48 in., for Water and Other Liquids
C111/A21.11-80	American National Standard for Rubber-Gasket Joints for Ductile-Iron and Gray-Iron Pressure Pipe and Fittings
C151/A21.51-81	American National Standard for Ductile-Iron Pipe, Centrifugally Cast in Metal Molds or Sand-Lined Molds, for Water or Other Liquids
<b>FS</b>	Federal Specifications* National Bureau of Standards Office of Engineering Standards U.S. Department of Commerce Washington, D.C. 20234  *Standards are available from the Superintendent of Documents, U.S. Government Printing Office, Washington, D.C. 20402
<b>Standard Reference Number</b>	<b>Title</b>
TT-P-1536A	Plumbing Fixture Setting Compound, July 1975
QQ-L-201f	Lead Sheet, November 1965 with Amendment 2, November 1970
WW-P-325B	Lead Pipe, Bends, Traps, Caps and Plugs (for Industrial Pressure, and Soil and Waste Applications), June 1976
WW-P-405a	Corrugated Pipe (Iron or Steel, Zinc Coated), September 1968, with Amendment 1, September 1970
<b>WQA</b>	Water Quality Association 477 East Butterfield Road Lombard, Illinois 60148
<b>Standard Reference Number</b>	<b>Title</b>
S-100-81	Household, Commercial and Portable Exchange Water Softeners

**ILHR 84****APPENDIX**

The material contained in this appendix is for clarification purposes only. The notes, illustrations, etc., are numbered to correspond to the number of the rule as it appears in the text of the code.

**A-84.13 Penetrations of fire resistive assemblies.** The following sketches depict possible methods of penetrating fire resistive assemblies with plumbing piping systems. For the current acceptable methods, contact the Bureau of Buildings and Structures, P.O. Box 7969, Madison, Wisconsin 53707.

A-84.13 Penetrations of fire resistive assemblies.

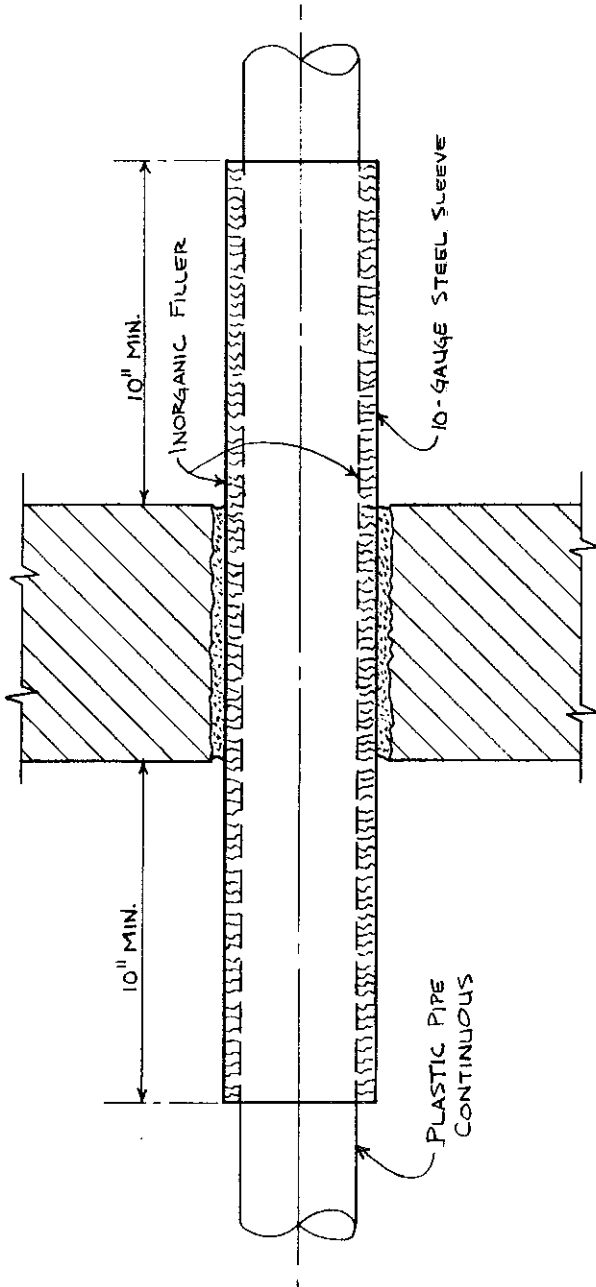

10" GA. SLEEVE ONE INCH DIA. LARGER THAN PIPE

A-84.13 Penetrations of fire resistive assemblies.

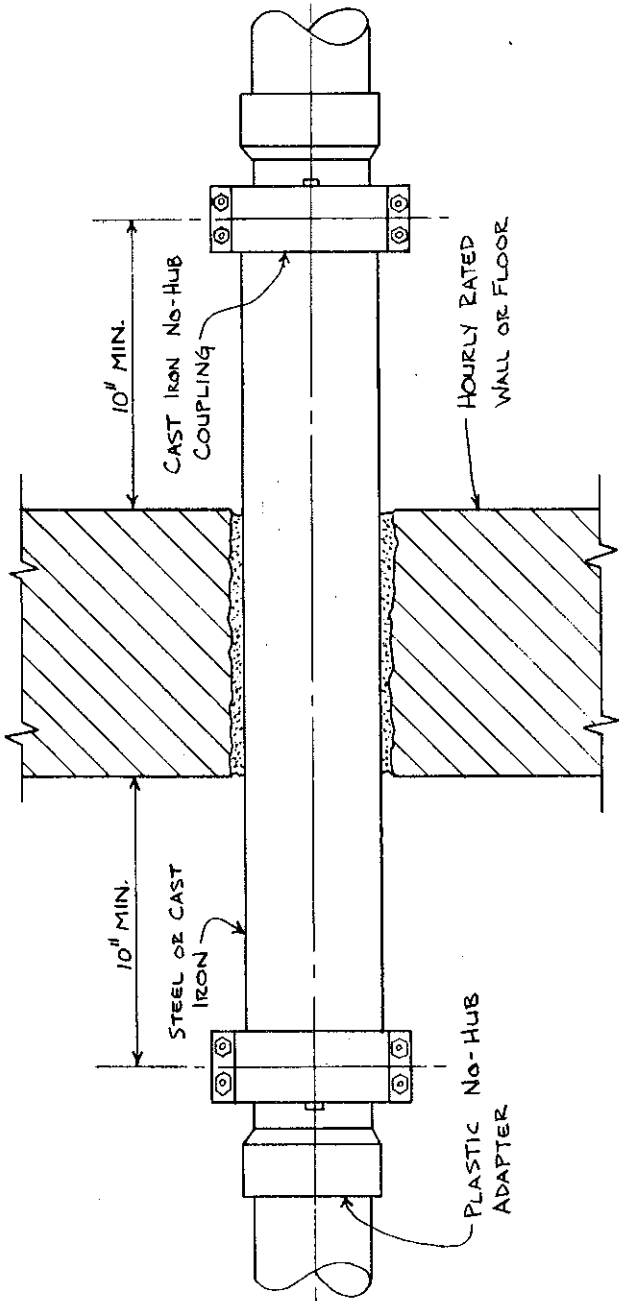

SUBSTITUTION OF CAST IRON OR STEEL PIPE

A-84.13 Penetrations of fire resistive assemblies.

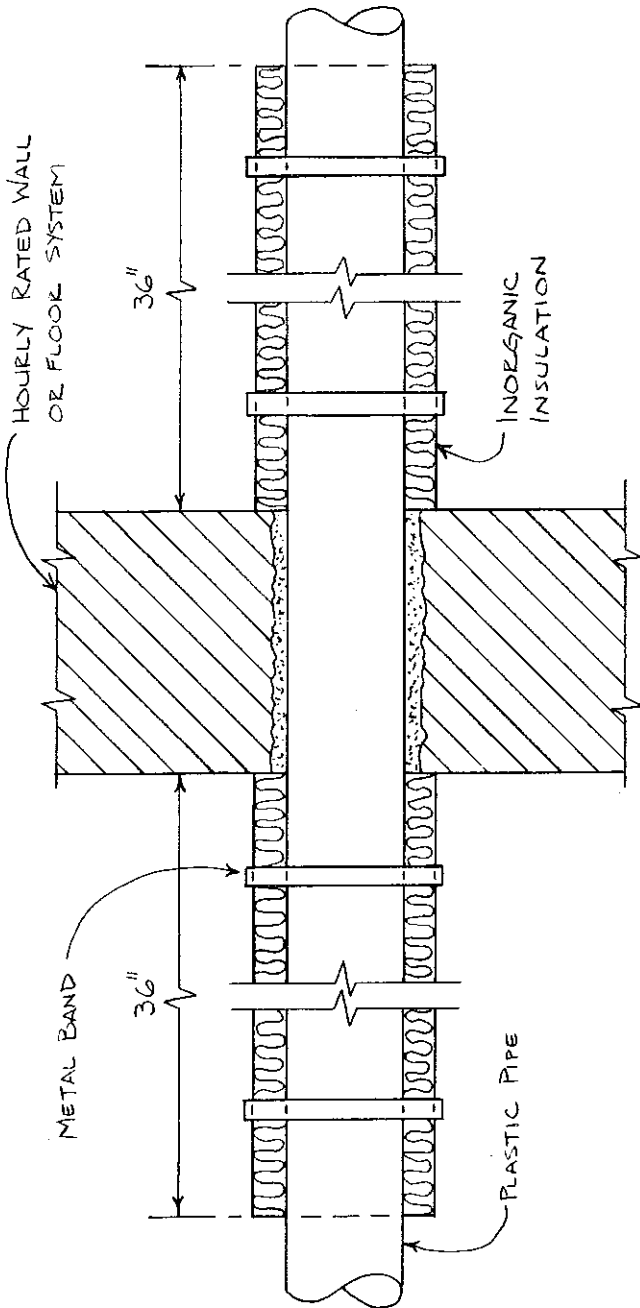

WRAP PLASTIC WITH 1" THICK INSULATION

A-84.13 Penetrations of fire resistive assemblies.

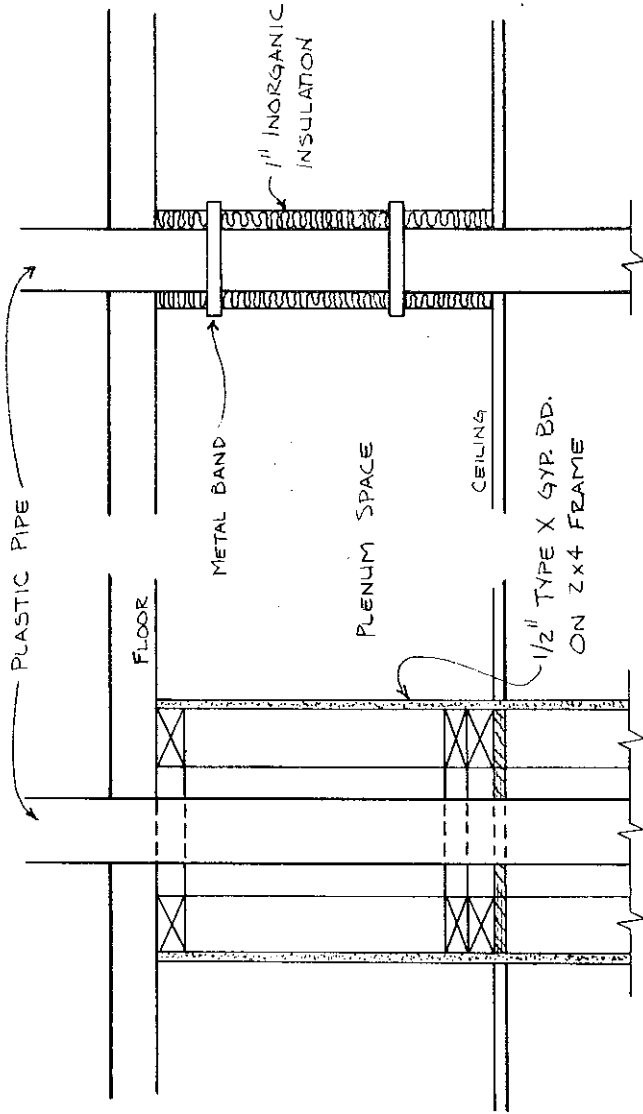



A-84.20 (3) ACCESSIBLE TOILET ROOMS AND SANITARY FACILITIES. The following sketches and diagrams are a reprint from the 1984 edition of the Building and Heating, Ventilating and Air Conditioning, chapters ILHR 50-64. For the current accessibility requirements, contact the Bureau of Buildings, P.O. Box 7969, Madison, Wisconsin 53707.

EXAMPLES OF ACCESSIBLE TOILET COMPARTMENTS  
AS SPECIFIED IN TABLE 52.04-A

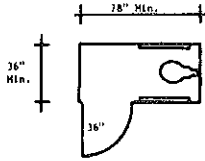

Recommended fixtures:

1. Elongated bowl;
2. Wall mounted.

Note: These are examples of toilet room compartments which are located within accessible toilet rooms.

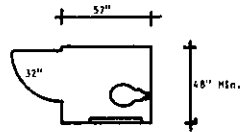
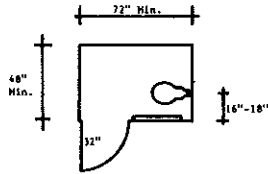
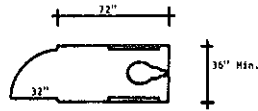
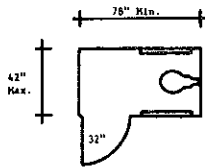

The door of the 48" x 57" water closet compartment having a frontal approach should not align with the placement of the water closet.

EXAMPLES OF ACCESSIBLE TOILET ROOMS  
CONTAINING ONE LAVATORY AND ONE WATER CLOSET

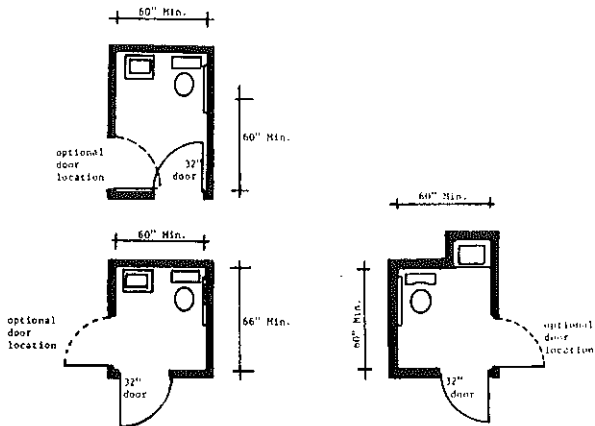

**Note #1:** These examples of accessible toilet rooms may be used in health care facilities in that sufficient room for the attendant is provided.

**Note #2:** These examples may be modified by substituting pocket sliding doors for the swing doors shown in the examples. Surface-mounted hardware is recommended for pocket sliding doors.

EXAMPLES OF ACCESSIBLE BATHROOM LAYOUTS  
FOR RESIDENTIAL LIVING UNITS

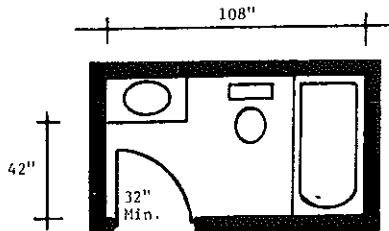
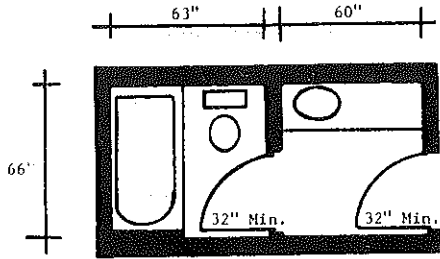
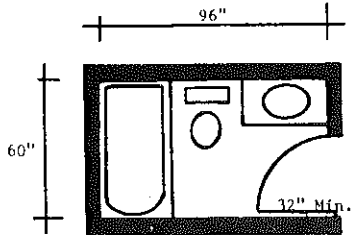

EXAMPLES OF ACCESSIBLE TOILET ROOMS

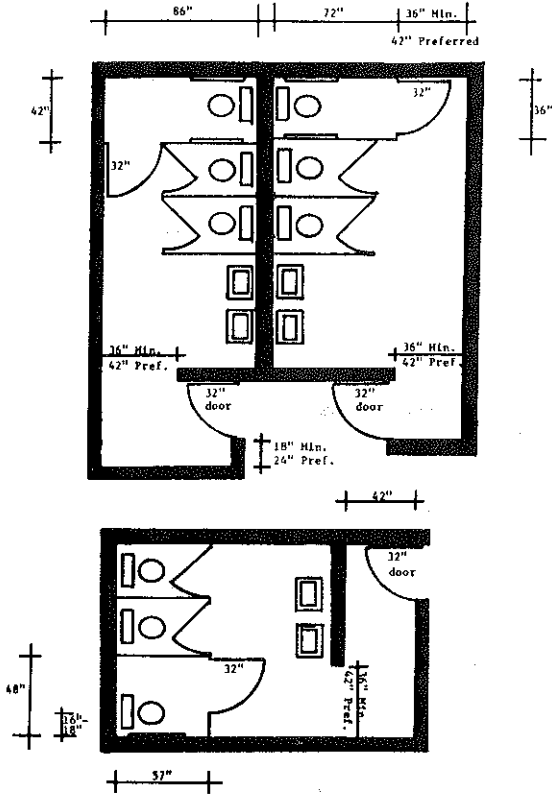

ACCESSIBLE TOILET ROOMS

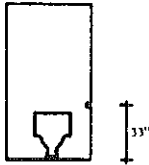

It is recommended that grab bars be from 30 to 42 inches in length and located no more than 12 inches from the back wall.

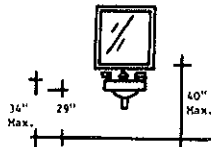
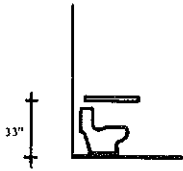

ACCESSIBLE BATHING FACILITIES

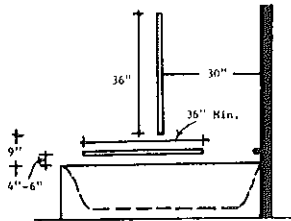

Side Elevation - Bathtub

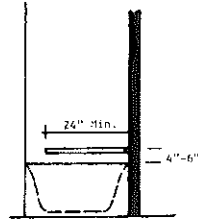

End Elevation - Bathtub

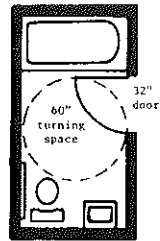
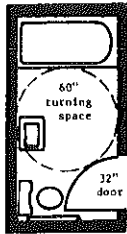

These diagrams are examples of accessible bathrooms which may be used for motels, hotels, hospitals and nursing homes.

ACCESSIBLE BATHING FACILITIES

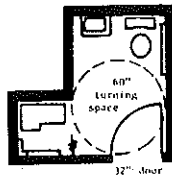
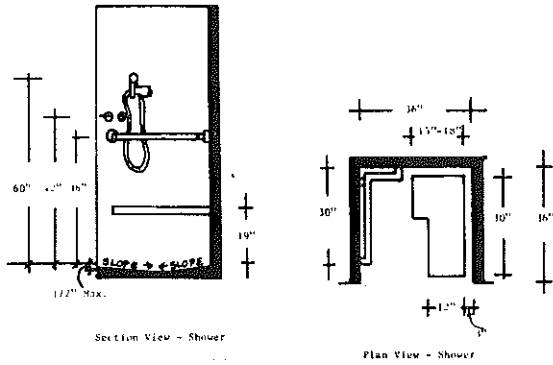



EXAMPLES OF ADAPTABLE BATHROOM LAYOUTS  
FOR RESIDENTIAL LIVING UNITS  
(not including hotels and motels)

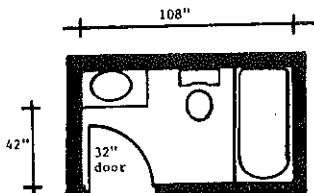
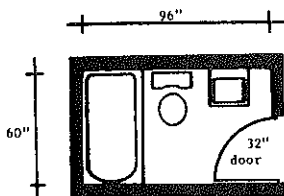

These examples may be modified for accessibility by using outward swinging doors or pocket sliding doors.

EXAMPLES OF ACCESSIBLE WATER COOLERS

Note: Conventional floor-mounted water coolers can be serviceable to patrons with functional limitations if a small fountain is mounted on the side of the cooler 30 inches above the floor. Fully recessed water fountains are not recommended and should not be recessed in an alcove unless the alcove is wider than the wheelchair.

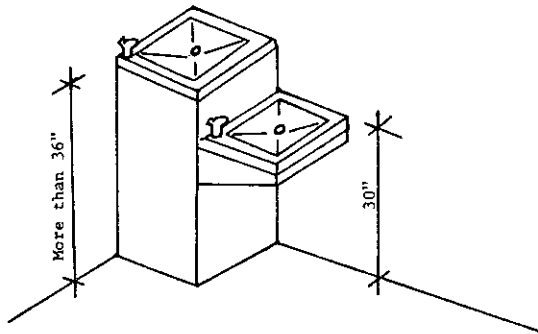
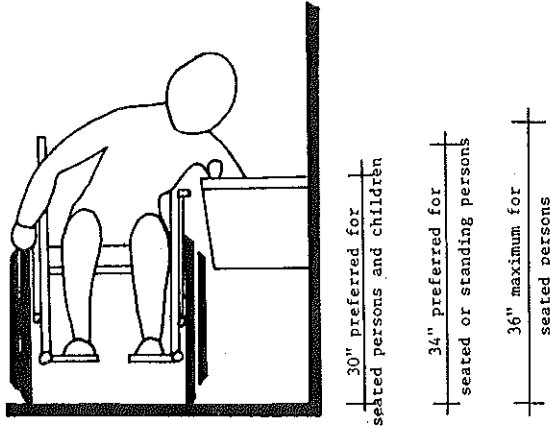

Floor-mounted water cooler with side-mounted cooler

A-84.20 (4) Spacing of plumbing fixtures.

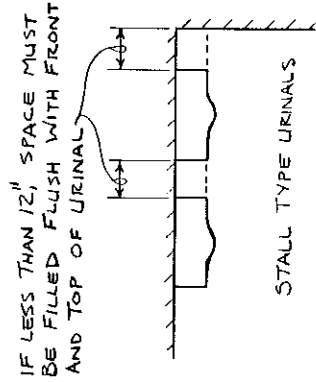
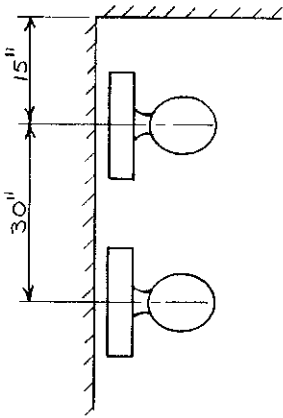

STALL TYPE URINALS

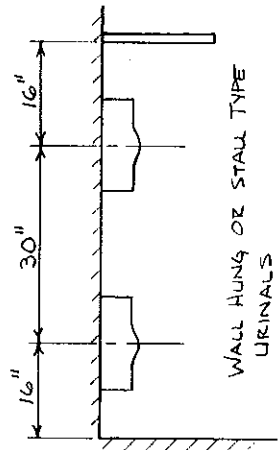
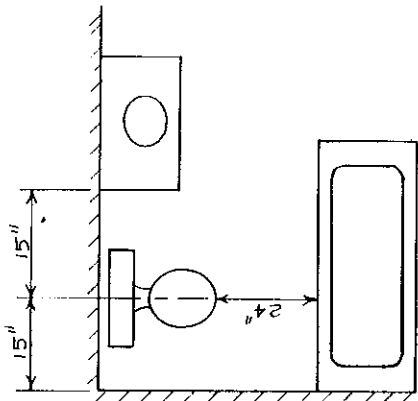

WALL HUNG OR STALL TYPE URINALS

A-84.20 (4) Minimum size of shower compartments.

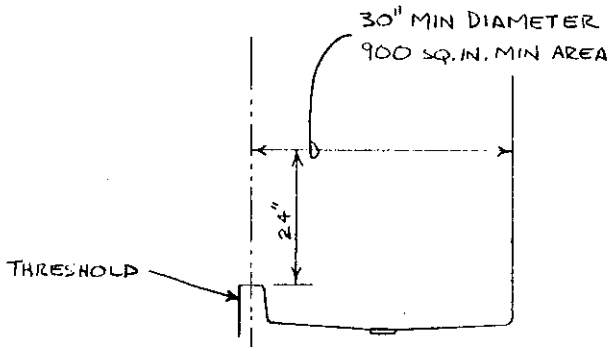
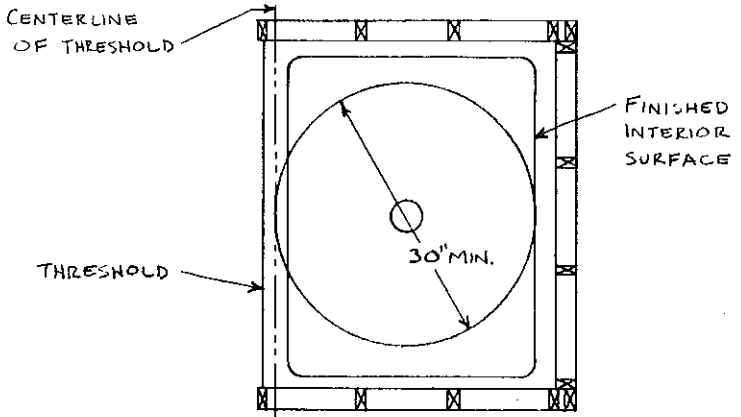



## Chapter ILHR 85

### SUBDIVISIONS NOT SERVED BY PUBLIC SEWERS

**SUBCHAPTER I — Scope and Application**  
ILHR 85.001 Purpose (p. 423)  
ILHR 85.002 Scope (p. 423)  
ILHR 85.003 Application (p. 423)  
ILHR 85.004 Community systems (p. 424)  
ILHR 85.01 Definitions (p. 424)  
**SUBCHAPTER II — Administration and Enforcement**  
ILHR 85.02 Department review (p. 426)

**SUBCHAPTER III — Lot Standards**  
ILHR 85.03 Lot area and average lot widths (p. 427)  
ILHR 85.04 Elevation (p. 428)  
ILHR 85.05 Outlot restrictions (p. 430)  
**SUBCHAPTER IV — Soil Evaluation**  
ILHR 85.06 Soil tests (p. 431)

**Note:** Chapter H 65 as it existed on May 31, 1983 was repealed and a new Chapter ILHR 85 was created effective June 1, 1983.

#### SUBCHAPTER I—SCOPE AND APPLICATION

**ILHR 85.001 Purpose.** Pursuant to s. 145.23, Stats., the purpose of this chapter is to promote public health by establishing minimum lot sizes and lot elevations necessary for proper sewage disposal in subdivisions not served by a public sewer.

**History:** Cr. Register, May, 1983, No. 329, eff. 6-1-83.

**ILHR 85.002 Scope.** (1) The provisions of this chapter apply to all proposed subdivisions that include proposed lots which are not to be served by existing public sewers or where provisions assuring for such service have not been made. Provisions assuring the availability of public sewer service shall be made through city, village, town or town sanitary district resolution or other official action requiring that all buildings within the proposed subdivision be served by public sewers prior to occupancy.

(2) Pursuant to s. 236.45, Stats., when required by local ordinance, the provisions of this chapter will apply to other divisions of land that do not meet the definition specified in s. ILHR 85.01 (21) for subdivision.

**Note:** Upon request, the department will review and comment on plans for other proposed divisions of land provided the appropriate fee as specified in s. Ind 69.22, Wis. Adm. Code, is received.

**History:** Cr. Register, May, 1983, No. 329, eff. 6-1-83.

**ILHR 85.003 Application.** The application of this chapter shall be limited as follows:

(1) The requirements in ss. ILHR 85.03 to 85.06 apply only to subdivision lots that will have one single family dwelling and one on-site sewage disposal system.

(2) For all other subdivision lots that do not fall within the scope of sub. (1), written department approval as to the availability of suitable soils for soil absorption shall be obtained prior to submitting a plat for review in accordance with s. 236.12, Stats.

(a) Department acceptance shall not be issued unless adequate initial and replacement areas for soil absorption are available to dispose of the proposed wastewater flows specified in ch. ILHR 83.

(b) The soil absorption areas shall comply with the site and soil test requirements of ch. ILHR 83.

History: Cr. Register, May, 1983, No. 329, eff. 6-1-83.

**ILHR 85.004 Community systems.** Where individual subdivision lots are to be served by a community system of collection and disposal of sewage effluent by soil absorption, the recorded final plat shall be clearly marked to indicate this condition.

(1) If the components of such a community system are not in place and available to all of the lots when a plat is received by the department for review in accordance with s. 236.12, Stats., the department shall not certify that plat until the city, village, town or town sanitary district has, by resolution or other official action, required that buildings within the subdivision will be served by the community system prior to occupancy.

(2) All components of a community system shall be owned and maintained by a special purpose district.

(3) All components of a community system shall be accessible through easements, public right-of-ways or land ownership.

(4) (a) The effective soil absorption area for a community system shall be provided by at least 3 areas of equivalent size that together total at least 150% of the minimum area required under s. ILHR 85.003 (2).

(b) Each third of the effective soil absorption area shall alternately rest for 12 month periods, during which time each of the other 2 thirds shall be alternately dosed with a distribution supply pressure of at least 2.5 feet of head.

History: Cr. Register, May, 1983, No. 329, eff. 6-1-83.

**ILHR 85.005 Saving and severable clauses.** History: Cr. Register, May, 1983, No. 329, eff. 6-1-83; r. under s. 13.93 (2m) (b) 16 Stats., Register, February, 1985, No. 350.

**ILHR 85.01 Definitions.** For the purpose of this chapter, the following terms are defined as:

(1) "Approved" means being acceptable to the department.

(2) \* "Average lot width" means the number computed by using distances between nonparallel side lot lines which are perpendicular to the line bisecting the angle formed by the side lot lines using the portion of the lot containing the minimum lot area. The average width between parallel lot lines is the perpendicular distance between them.

(3) "Bedrock" means the rocks that underlie soil material or that are at the earth's surface. Bedrock is encountered where the weathered in-place consolidated material larger than 2 millimeters in size is greater than 50% by volume.

(4) "Color" means the moist color of the soil based on the Munsell soil color charts.

(5) "Community water supply system" means a water system so designated and approved by the department of natural resources.

\*See Appendix for further explanatory material.

(6) "County" means the local governmental unit responsible for the regulation of private sewage systems as defined in s. 145.01 (15), Stats.

(10) "Minimum continuous suitable soil area" means that area of a lot which is contiguous and meets all of the requirements specified in s. ILHR 85.04 relating to flooding, high groundwater, bedrock, permeability, land slope and size.

(11) "Minimum lot area" means the area specified in s. ILHR 85.03 as the minimum area for a given situation.

(12) "Mound system" means a soil absorption system complying with the requirements of s. ILHR 83. 23.

(13) "Outlot" means a parcel of land, other than a lot or block, so designated on the plat.

(14) "Percolation test" means the method specified in s. ILHR 85.06 of testing absorption qualities of the soil.

(15) "Permeability" means the ease with which liquids move through soil.

(16) "Plat" means a map of a subdivision.

(17) "Public sewer" means sewers and treatment facilities used in connection therewith that ultimately result in surface discharge of effluent and that are also acceptable to or approved by the department of natural resources.

(18) "Soil" means all unconsolidated material overlying bedrock.

(19) "Soil boring" means an observation pit dug by hand or backhoe, a hole dug by augering or a soil core taken intact and undisturbed with a probe.

(20) "Soil saturation" means the state where all the pores in a soil are filled with water. Water will flow from saturated soil into a soil boring.

(21) "Subdivision" means a division of a lot, parcel or tract of land by the owner thereof, or the owner's agent for the purpose of sale or of building development, where:

(a) The act of division creates 5 or more parcels or building sites of 1½ acres each or less in area; or

(b) Five or more parcels or building sites of 1½ acres each or less in area are created by successive divisions within a period of 5 years.

Note: See s. ILHR 85.002 as to the application of this chapter as it pertains to land divisions that are defined by local ordinance as subdivisions.

(22) "System" means a soil absorption system for disposal of sewage effluent.



## SUBCHAPTER II—ADMINISTRATION &amp; ENFORCEMENT

**ILHR 85.02 Department review.** \* (1) **SUBMITTAL.** (a) Plats of proposed subdivisions not served by public sewers shall be submitted to the department in accordance with the procedures specified in s. 236.12, Stats. Pursuant to s. 236.12 (3), Stats., the department shall review the plat and grant an approval or issue an objection within 20 calendar days of receiving copies of the plat.

(b) In accordance with ch. 236, Stats., at least 3 copies of the plat for a proposed subdivision not served by public sewers shall be provided to the department for review.

(2) **PLATS.** All copies of plats submitted for department review shall be clear, legible and permanent, and shall include sufficient information for the department to judge if the proposed subdivision complies with the requirements of this chapter.

(a) Applicable information to be provided on a plat shall include, but not limited to:

5. Lot areas not meeting the minimum continuous suitable soil area requirements specified in s. ILHR 85.04.

(b) Applicable data to accompany the plat shall include, but not limited to:

1. Soil boring data;
2. Soil profile descriptions;
3. Percolation test data; and
4. Groundwater monitoring data.

(3) **FORMS.** Data for all soil tests shall be submitted on forms furnished by the department. The forms shall be signed by a soil tester who is certified by the department.

*Note:* Forms furnished by the department may be used for other purposes, if the purpose is identified on the form by the soil tester.

(4) **INVESTIGATIONS.** (a) The department or county may conduct field investigations to verify, including, but not limited to:

1. Depth to soil mottles;
2. Depth to observed groundwater;
3. Soil textures;
4. Depth to bedrock;
5. Land slope; and
6. Soil percolation rates.

(b) The department or county may require backhoe pits to be provided and may require percolation tests to be conducted under department or county supervision.

\*See Appendix for further explanatory material.

(c) The department or county may require the monitoring of ground-water levels in accordance with s. ILHR 85.06 (4) for proposed subdivisions where the natural soil has been altered.

(5) **REVOCAION OF CERTIFICATION.** The department may rescind plat certification, issued under the provisions of this chapter, for any false statements or representation of facts on which the certification was issued.

(6) \* **FEES.** Fees for department plat review and field investigations shall be submitted in accordance with s. Ind 69.22, Wis. Adm. Code.

(7) **PENALTIES.** The department may impose penalties and obtain additional remedies for violations of this chapter or ch. 236, Stats., as provided in ss. 145.02 (3) (f), 145.12 (1) and (2), and 236.31 (2), Stats.

Note #1: Section 145.02 (3) (f), Stats., states that the department may issue special orders directing and requiring compliance with the rules and standards of the department promulgated under this chapter whenever, in the judgment of the department, the rules or standards are threatened with violation, are being violated or have been violated. The circuit court for any county where violation of such an order occurs has jurisdiction to enforce the order by injunctive and other appropriate relief. The attorney general or the district attorney of the county where the violation of the order occurs shall bring action for its enforcement. The department may issue an order under this paragraph to abate a violation of s. 146.13 or 146.14.

Note #2: Section 145.12 (1), Stats., states that any person, firm or corporation who otherwise violates any provisions of this chapter, shall be fined not less than \$10 nor more than \$100 or imprisoned for 30 days or both. Each day such violation continues shall be a separate offense.

Note #3: Section 145.12 (2), Stats., states that any person violating this chapter or failing to obey a lawful order of the department, or a judgment or decree of a court in connection with this chapter, may be imprisoned for not more than three months or fined not more than \$100.

Note #4: Section 236.31 (2), Stats., states that any municipality, town, county or state agency with subdivision review authority may institute injunction or other appropriate action or proceeding to enjoin a violation of any provision of this chapter, ordinance or rule adopted pursuant to this chapter. Any such municipality, town or county may impose a forfeiture for violation of any such ordinance, and order an assessor's plat to be made under s. 70.27 at the expense of the subdivider or his agent when a subdivision is created under s. 236.02 (8) (b) by successive divisions.

History: Cr. Register, May, 1983, No. 329, eff. 6-1-83; am. (1) (a), Register, February, 1985, No. 350, eff. 3-1-85.

### SUBCHAPTER III—LOT STANDARDS

**ILHR 85.03 Lot area and average lot widths.** (1) **GENERAL.** The area of any unsewered lot shall be sufficient to permit the installation and use of a soil absorption system and one replacement system based upon the results of soil tests conducted in accordance with s. ILHR 85.06.

(2) **AREA AND WIDTH.** Except as provided in sub. (3), each lot, based upon its percolation rate classification and its water supply system, shall have a minimum lot area and a minimum average lot width not less than that specified in Table 85.03. Any portion of a lot having a width of less than 30 feet shall not be considered in determining the minimum lot area.

(a) *Community water supply.* The department shall consider a community water supply system available, if plans for such a supply system have been approved by the department of natural resources. In addition, the controlling local governmental unit shall by resolution or other offi-

\*See Appendix for further explanatory material.

cial action require water service lines to be extended to buildings within the subdivision prior to occupancy.

(b) *Easements.* 1. Any easement or combination of adjacent easements which is greater than 20 feet wide shall not be considered in determining minimum lot area unless approved in writing by the department.

2. The minimum lot area shall not be divided by any easement unless approved in writing by the department.

(3) **LOT COMBINATIONS.** Pending installation of public sewers, the minimum lot areas and the minimum average lot widths specified in Table 85.03 may be provided through use of 2 or more lots, if suitable lot combinations are designated on the recorded final plat.

**Table 85.03**  
**LOT AREAS AND WIDTHS**

Class	PERCOLATION RATE	PRIVATE WATER SUPPLY SYSTEMS			COMMUNITY WATER SUPPLY SYSTEMS		
		Minutes Required for Water to Fall One Inch	Minimum Lot Area (square feet)	Minimum Average Lot Width (feet)	Minimum Continuous Suitable Soil Area (square feet)	Minimum Lot Area (square feet)	Minimum Average Lot Width (feet)
1	Under 10	20,000	100	10,000	12,000	75	6,000
2	10 to less than 30	20,000	100	10,000	14,000	75	7,000
3	30 to less than 45	25,000	100	12,500	16,000	75	8,000
4	45 to 60	30,000	100	15,000	18,000	100	9,000
5	greater than 60 to 120 (mound systems only)	30,000	100	15,000	18,000	100	9,000

Note: Chapter NR 112, Wis. Adm. Code, requires a 1,200 foot separation between potable water supply wells and proposed or existing sanitary landfills. The department of natural resources should be consulted if a community water supply well is located in or near a proposed unsewered subdivision.

History: Cr. Register, May, 1983, No. 329, eff. 6-1-83.

**ILHR 85.04 Elevation.** Unless reduced under sub. (7), each lot, based upon its percolation rate classification and its water supply system, shall have a minimum continuous suitable soil area not less than that specified in Table b 85.03. The minimum continuous suitable soil area shall meet all of the elevation requirements specified in this section relating to floodwater, high groundwater, bedrock, permeability and land slopes.

(1) **FLOODWATER.** (a) *Rivers, streams and flow-through lakes.* All of a lot's minimum continuous suitable soil area and at least 90% of a lot's minimum lot area shall be above the elevation of the regional flood as defined in ch. NR 116, Wis. Adm. Code. Where this is a factor, the regional flood elevation shall be delineated and so labeled on the recorded final plat. This elevation shall be verified by the department of natural resources.

(b) *Other bodies of water.* All of a lot's minimum continuous suitable soil area and at least 90% of a lot's minimum lot area shall be at least 2 feet

Register, February, 1985, No. 350

above the highest known water elevation of any body of water not covered under par. (a). Where this is a factor, the contour 2 feet above the highest known water elevation shall be delineated and so labeled on the recorded final plat.

(2) **GROUNDWATER AND BEDROCK.** (a) *Subsurface systems.* Except as provided in par. (b), the minimum continuous suitable soil area shall have a minimum of 3 feet of soil between the bottom of the proposed systems and high groundwater and bedrock.

(b) *Mound systems.* Where mound systems are proposed, the minimum continuous suitable soil area shall have a minimum of 2 feet of soil from existing grade to high groundwater and bedrock.

(c) *Noncomplying areas.* Any lot areas not meeting the requirements of pars. (a) or (b) shall be delineated on all plats.

(3) **PERMEABILITY.** (a) *Subsurface systems.* Except as provided in par. (b), within the minimum continuous suitable soil area, a percolation rate of 60 minutes per inch or faster shall exist for the depth of the proposed systems and to at least 3 feet below that.

(b) *Mound systems.* Within the minimum continuous suitable soil area where mound systems are proposed, a percolation rate of 120 minutes per inch or faster shall exist for a depth of at least 2 feet below the existing grade.

(c) *Noncomplying areas.* Any lot areas not meeting the requirements of par. (a) or (b) shall be delineated on all plats.

(4) **LAND SLOPES.** (a) *Subsurface systems.* 1. Except as provided in par. (b), land slopes within the minimum continuous suitable soil area shall not exceed 20%. A land surveyor registered in Wisconsin shall certify that all minimum continuous suitable soil areas do not have any land slopes exceeding 20 percent.

2. Areas where land slopes exceed 20% shall be accurately delineated on a plat.

(b) *Mound systems.* 1. Where mound systems are proposed:

a. Land slopes shall not exceed 12% within minimum suitable soil areas with percolation rates of 30 minutes per inch or faster; or

b. Land slopes shall not exceed 6% within minimum suitable soil areas with percolation rates slower than 30 minutes per inch, but not slower than 120 minutes per inch.

2. A land surveyor shall certify to the department that all minimum continuous suitable soil areas for proposed mound systems are free of land slopes exceeding the percentages of subd. 1.

(5) **MOUND SYSTEMS.** The recorded final plat shall clearly indicate which lots, if any, must use mound systems due to the availability of suitable soils.

(6) **EASEMENTS.** Minimum continuous suitable soil areas shall not include any easement, unless approved in writing by the department.

(7) **REDUCED MINIMUM CONTINUOUS SUITABLE SOIL AREAS.** The minimum continuous suitable soil areas may be reduced to not less than the

minimums specified in Table 85.04 if building area, well area and 2 system areas are preplanned and designated on the recorded final plat.

(a) *General.* The shape and location of such preplanned areas shall be such that 2 trench type systems can be installed to serve a 4 bedroom home.

1. Preplanned areas shall be clearly shown either on all plats or on separate sheets, provided that the recorded final plat is clearly marked to show which lots have preplanned areas.

2. No changes in preplanned areas may be made unless approved in writing by the department.

**Table 85.04**  
**PREPLANNED LOTS**

LOT CLASS	MINIMUM SQUARE FEET REQUIRED FOR EACH PREPLANNED SYSTEM AREA (MINIMUM OF TWO AREAS REQUIRED)
1	2,000
2	3,000
3	3,600
4	3,900

(b) *Separating distances.* The reduced minimum continuous suitable soil areas shall be at least:

1. Fifty feet from the high water mark of any lake, stream or other watercourse, well or water reservoir;

2. Twenty-five feet from any habitable building or dwelling or building with below grade foundation which will remain in use after sale of the lot;

3. Twenty feet from the top of land slopes exceeding 20% except where the top of the aggregate of a system is at or below the level of the flow line of an adjacent roadside ditch; and

4. Five feet from any lot line.

(c) *Approved comparable lot layout design.* When compliance with the requirements of this section is impractical and satisfactory proof is provided that systems can be installed in complete accord with ch. ILHR 83, the department may approve in writing further reductions in depths and areas of the minimum continuous suitable soils.

Note: Chapter ILHR 83 contains requirements for systems proposed to be installed at sites which have been altered by filling or attempts to overcome steep slopes.

History: Cr. Register, May, 1983, No. 329, eff. 6-1-83.

**ILHR 85.05 Outlot restrictions.** Any outlots that do not meet the lot area, width, or elevation requirements specified in ss. ILHR 85.03 and 85.04 shall be restricted by a clearly labeled restriction on the recorded final plat. This restriction shall prohibit the construction of buildings for human habitation until public sewers are available and shall prohibit the installation of soil absorption systems on such outlots.

History: Cr. Register, May, 1983, No. 329, eff. 6-1-83.

Register, February, 1985, No. 350

SUBCHAPTER IV—SOIL EVALUATION

**ILHR 85.06 Soil tests.** The evaluation of soil profiles, percolation testing and monitoring of groundwater shall be conducted by a soil tester certified by the department. Either the soil tester or land surveyor shall certify on a plat submitted to the department that all soil test sites shown thereon are accurately located and that all soil test depths are referenced to the final grade of the subdivision as established during the time of testing.

**Note #1:** Forms furnished by the department can be used for other purposes if the purpose is identified on the form by the soil tester.

**Note #2:** Since there can be considerable variation in the ability of soil to absorb sewage effluent on the individual lots in an approved subdivision, attention is directed to the necessity of conducting individual lot soil borings, profile evaluations and percolation tests as specified in ch. ILHR 83 prior to construction of any system.

(1) **SOIL BORINGS.** Each soil boring shall be of a size and extent to determine the soil characteristics important to on-site liquid waste disposal. Soil borings shall be conducted prior to percolation testing to determine whether the soils are suitable to warrant percolation tests and if suitable, at what depths percolation tests shall be conducted.

(a) *General.* The use of power augers for soil borings is prohibited. If soil borings are not dug with a backhoe, the soil tester shall so report on the soil test data form. The soil borings shall be distributed as uniformly as possible and their locations shall be shown on a plat submitted to the department.

(b) *Number of soil borings.* 1. At least one soil boring per acre shall be made initially, if a detailed soil map for the area is not available to the department.

2. At least one soil boring per 3 acres shall be made initially, if a detailed soil map for the area is available to the department.

3. Where initial soil borings indicate marked variations in depths to bedrock, high groundwater or restrictive permeability, at least 2 soil borings per acre shall be made.

4. Where proposed lot areas exceed one acre and where uniform soil conditions exist, at least one soil boring per 5 acres shall be made.

(c) *Depth of soil borings.* 1. All soil borings shall extend to a depth of at least 6 feet or to bedrock, if present at a lesser depth.

2. All soil borings in minimum continuous suitable soil areas shall extend at least 4 feet below an expected depth of a system.

3. The depth of a soil boring shall be referenced to the final grade of the subdivision.

(2) **SOIL PROFILE DESCRIPTIONS.** Soil profile descriptions shall be written for all borings.

(a) *General.* Soil profile descriptions shall indicate the thickness in inches of the different soil horizons observed. Horizons shall be differentiated on the basis of color, texture, soil mottles or bedrock.

(b) *Data.* Soil profile descriptions shall include:

1. The depth to observed groundwater, if present;

2. The depth to bedrock, if present;
3. The depth to soil mottling, if present;
4. An estimated depth to high groundwater; and
5. The texture and color of the soil horizons.

(c) *Observed groundwater.* Observed groundwater shall be reported at the level groundwater reaches in the boring or at the highest level of sidewall seepage into the boring. Measurements shall be made from ground surface. Soil above the water level in the soil boring shall be checked for the presence of soil mottles.

(d) *Bedrock.* The depth to bedrock except monolithic sandstone shall be established at the depth in a soil profile where greater than 50% of the weathered in-place material is consolidated. Monolithic sandstone bedrock shall be established at the depth where an increase in resistance to penetration of a knife blade occurs.

(e) *Soil mottles.* Zones of seasonal or periodic soil saturation shall be estimated at the highest level of soil mottles. The department or county may require a detailed description of the soil mottles on a marginal site. The abundance, size, contrast and color of the soil mottles should be described in the following manner:

1. Abundance: a. Few, if the mottled color occupies less than 2% of the exposed surface;

b. Common, if the mottled color occupies from 2 to 20% of the exposed surface; or

c. Many, if the mottled color occupies more than 20% of the exposed surface.

2. Size, referring to length of the mottle measured along the longest dimension:

a. Fine, if the mottle is less than 5 millimeters;

b. Medium, if the mottle is from 5 millimeters to 15 millimeters; or

c. Coarse, if the mottle is greater than 15 millimeters.

3. Contrast, referring to the difference in color between the soil mottle and the background color of the soil:

a. Faint, if the mottle is evident but recognizable only with close examination;

b. Distinct, if the mottle is readily seen but not striking; or

c. Prominent, if the mottle is obvious and one of the outstanding features of the horizon.

4. Color of the mottle.

(f) *Color patterns not indicative of soil saturation.* 1. One foot exception. Soil profiles that have an abrupt textural change of finer textures overlying at least 4 feet of unmottled, loamy sand or coarser textures, can have a mottled zone in the finer textures. If the mottled zone is less than 12 inches thick and is immediately above the textural change, then

a system may be installed in the underlying loamy sand or coarser textures. If any soil mottles occur within the underlying loamy sand or coarser textures, then the site shall be unsuitable. The department or county may determine certain coarse sandy loam soils to be included as a coarse material.

2. Other soil color patterns. Soil mottles can occur that are not due to zones of seasonal or periodic soil saturation. Examples of such soil conditions not limited by enumeration are as follows:

a. Soil mottles formed from residual sandstone deposits;

b. Soil mottles formed from uneven weathering of glacially deposited material, or glacially deposited material that may have been originally gray in color. This may include concretionary material in various stages of decomposition;

c. Deposits of lime in a profile derived from highly calcareous parent material;

d. Light colored silt or dark colored clay coats deposited on soil ped faces;

e. Soil mottles that are usually vertically oriented along old or decayed root channels with a dark organic stain usually present in the center of the mottled area; and

f. Greenish colored calcite deposits.

3. Reporting exceptions. A soil tester shall not disregard any mottled soil condition. If soil mottles are observed that may not be due to periodic saturation, the soil tester shall report such condition and may request a determination from the department or county as to suitability of the site.

(3) PERCOLATION TESTS AND PROCEDURES. Percolation tests shall be distributed as uniformly as possible in suitable soil areas and their locations shall be shown on a plat submitted to the department.

(a) *Percolation test hole.* A percolation test hole shall be dug or bored. The hole shall have vertical sides and have a horizontal dimension of 4 to 8 inches. The bottom and sides of the hole shall be carefully scratched with a sharp pointed instrument to expose the natural soil. All loose material shall be removed from the hole and the bottom shall be covered with 2 inches of gravel or coarse sand.

(b) *Number of percolation tests.* 1. At least one percolation test per acre shall be made initially, if a detailed soil map for the area is not available to the department.

2. At least one percolation test per 3 acres shall be made initially, if a detailed soil map for the area is available to the department.

3. Where percolation test results indicate marked variations in soil permeability, at least 2 percolation tests per acre shall be made.

4. Where proposed lot areas exceed one acre and where uniform soil conditions exist, at least one percolation test per 5 acres shall be made.



5. Where loamy sand or coarser material exists for the thickness of the proposed systems and to at least 3 feet below that, percolation tests are not required.

6. The department may waive the necessity for conducting soil percolation tests where a detailed soil map clearly indicates soil permeability equivalent to the class of lot proposed. Such a waiver shall be obtained in writing from the department prior to the review of a preliminary or final plat submitted in accordance with ss. 236.11 and 236.12, Stats.

(c) *Depth of percolation test.* Except as provided in subs. 1. and 2., all percolation tests shall be made at the depth at which the soil absorption systems are to be installed. The final grade of the subdivision shall control the percolation test depth.

1. Additional percolation tests may be required at depths to 3 feet below proposed systems in order to show that percolation rates are 60 minutes per inch or faster therein.

2. Where mound systems are proposed, percolation tests shall be conducted within 12 to 24 inches from the ground surface at the depth of the estimated slowest permeability.

(d) *Test procedures in sandy soils.* For percolation tests conducted in sandy soils the percolation test hole shall be carefully filled with clear water to a minimum depth of 12 inches above the bottom of the hole. The time for this amount of water to seep away shall be determined and this procedure shall be repeated. If the water from the second filling of the hole seeps away in 10 minutes or less, the test may proceed immediately as follows. Water shall be added to a point not more than 6 inches above the gravel or coarse sand. Thereupon, from a fixed reference point, water levels shall be measured at 10 minute intervals for a period of one hour. If 6 inches of water seeps away in less than 10 minutes, a shorter interval between measurements shall be used, but in no case shall the water depth exceed 6 inches. If 6 inches of water seeps away in less than 2 minutes, the test shall be stopped and a rate of less than 3 minutes per inch shall be reported. The final water level drop shall be used to calculate the percolation rate. Soils not meeting the above requirements shall be tested as in par. (e).

(e) *Test procedures in nonsandy soils.* For percolation tests conducted in nonsandy soils, the percolation test hole shall be carefully filled with clear water and a minimum water depth of 12 inches shall be maintained above the bottom of the hole for a 4-hour period by refilling whenever necessary or by use of an automatic siphon. Water remaining in the hole after 4 hours shall not be removed. Thereafter, the soil shall be allowed to swell not less than 16 hours nor more than 30 hours. Immediately following the soil swelling period, the measurements for determining the percolation rate shall be made as follows. Any soil which has sloughed into the hole shall be removed and the water level shall be adjusted to 6 inches over the gravel or coarse sand. Thereupon, from a fixed reference point, the water level shall be measured at 30 minute intervals for a period of 4 hours unless 2 successive water level drops do not vary by more than 1/16 of an inch. At least 3 water level drops shall be observed and recorded. The hole shall be filled with clear water to a point not more than 6 inches above the gravel or coarse sand whenever it becomes nearly empty. Adjustment of the water level shall not be made during the last 3

Register, February, 1985, No. 350

measurement periods except to the limits of the last measured water level drop. If the first 6 inches of water seeps away in less than 30 minutes, the time interval between measurements shall be 10 minutes and the test shall be run for one hour. The water depth shall not exceed 6 inches at any time during the measurement period. The drop that occurs during the final measurement period shall be used in calculating the percolation rate.

(f) *Interpretation of percolation rates.* In interpreting percolation test results, the percolation rates for the same kind of soil which establish larger minimum lot areas shall be used to determine compliance with s. ILHR 85.03.

(4) **MONITORING GROUNDWATER LEVELS.** A property owner or developer has the option to provide documentation that soil mottling or other color patterns at a particular site are not an indication of seasonally saturated soil conditions or high groundwater levels. Documentation shall be made by monitoring groundwater observation wells in accordance with the procedures specified in this subsection.

(a) *Precipitation.* The monitoring shall only be conclusive in a near normal spring season when the precipitation equals or exceeds, for the consecutive periods of September 1st through the last day of February and March 1st to through May 31st, 8.5 inches and 7.6 inches, respectively.

1. The presence of water above a level 3 feet below the estimated system depth for a period of at least 7 days shall be indicative of unsuitable soils regardless of the amount of rainfall.

2. Precipitation totals shall be calculated from data gathered at weather stations of the national weather service or other approved recording stations.

3. In determining whether a near normal spring occurred where sites are subject to regional water tables, such as large areas of sandy soils, the fluctuation over the several year cycle shall be considered. In such cases, data obtained from the United States geological survey shall be used to determine if a regional water table was at or near its normal level.

(b) *Artificial drainage.* Areas where groundwater levels are to be monitored shall be carefully checked for drainage tile and open ditches which could have altered high groundwater levels. Where such factors are involved, documentation of the location, design, ownership and maintenance responsibilities for such drainage shall be provided. Documentation shall include proof that the drainage network has an adequate outlet that will be maintained. Sites drained by agricultural drain tile shall not be acceptable for system installation.

(c) *Monitoring procedures.* 1. Prior to beginning groundwater monitoring each year, the soil tester shall notify the department and county of intent to monitor. The department shall be consulted for number, location and depth of monitoring wells prior to installation.

2. Monitoring wells for observing groundwater levels shall be designed, constructed and installed in accordance with Figure 85.06.

Figure 85.06  
MONITORING WELL

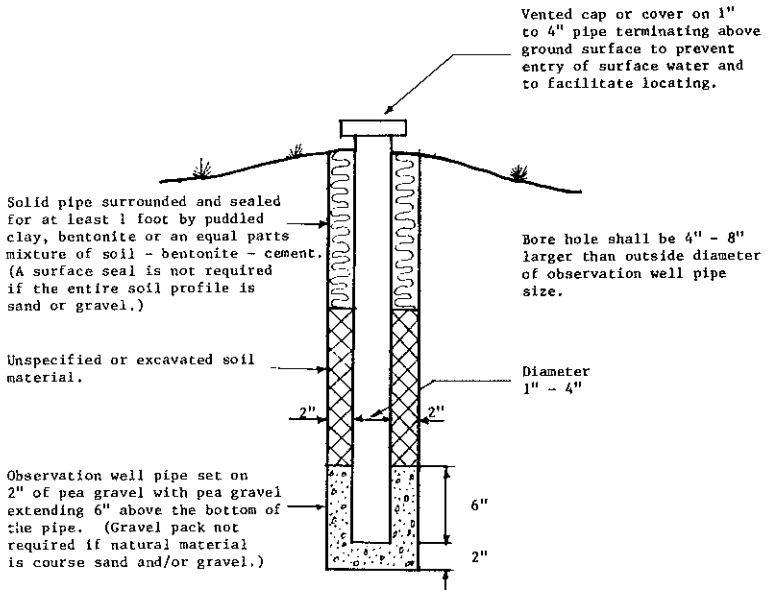

a. Except as provided in subpar. b., monitoring wells shall extend at least 3 feet below an expected depth of a system.

b. The department may require at least one well to be more than 3 feet deeper than proposed systems in areas subject to regional water tables.

(d) *Observations.* 1. The first observation and measurement of any groundwater in monitoring wells shall be made between March 1st and March 15th. Similar observations and measurements shall be made thereafter every 7 days or less until June 1st or until the site is determined to be unsuitable, whichever comes first. If water is observed at any time above a level 3 feet below the estimated system depth, an observation shall be made 4 days later. If water is present above a level 3 feet below the estimated system depth at both observations, the site shall be unsuitable. If water is not observed above a level 3 feet below the estimated system depth at the second observation, monitoring shall continue as originally scheduled.

2. The occurrence of rainfall of  $\frac{1}{2}$  inch or more within a 24 hour period during the monitoring may necessitate observations at more frequent intervals.

(e) *Percolation tests.* If monitoring of groundwater levels is conducted in mottled loess, the monitoring shall include percolation tests conducted in the loess at the proposed system depth and 3 feet below during the period of April 1st through April 22nd. The department shall supervise a representative number of such percolation tests.

(f) *Monitoring data.* Whether or not monitoring indicates suitable site conditions, one copy of the following groundwater monitoring data shall be submitted to the department and to the county. The data in subs. 7 and 8 is not required for unsuitable sites.

1. A map showing test locations, preferably at a scale of 1" = 100'.
2. Soil profile descriptions.
3. Soil series if available from soil maps.
4. Dates observed.
5. Depths of wells and results of observations.
6. Local precipitation data; monthly from September 1st to June 1st and daily during monitoring.
7. Ground elevations at the wells or a 2 foot topographic contour map of the area.
8. Information on artificial drainage.

(g) *Plat restriction.* Where expected depths to high groundwater are based on results of groundwater monitoring, the department may require a restriction on the plat prohibiting installation of systems below certain depths.

(5) **WINTER SOIL TESTING.** Soil testing shall be done only when weather and light conditions make accurate evaluation of site conditions possible. Soil testing attempted under winter conditions is difficult and precautions shall be observed.

(a) *Soil evaluations.* Soil profile evaluations conducted between November 15th and March 15th shall be in accordance with the following procedures:

1. Soil borings shall be made with a backhoe;
2. Soil profiles shall be evaluated only between the hours of 10:00 a.m. and 2:00 p.m. when the sky is not completely overcast; and
3. Frozen soil material shall be thawed for hand texturing.

(b) *Percolation tests.* Percolation tests that are unprotected shall be conducted only on days when the air temperature is 20° F or higher and the wind velocity is 10 mph or less. A heated structure or other protection from freezing shall be provided when the weather conditions listed above are not met. The bottom of the test hole shall be at least 12 inches below frost depth. If water freezes in the test hole at any time, the test data shall be void.

History: Cr. Register, May, 1983, No. 329, eff. 6-1-83.

**APPENDIX**

The material contained in this appendix is for clarification purposes only. The notes, illustrations, etc. are numbered to correspond to the number of the rule as it appears in the text of the chapter.

A 85.01 (1) Average Lot Width. The following illustrations and formulas are provided to explain the methods of average lot width determination.

(a) *Parallel Lot Lines.*

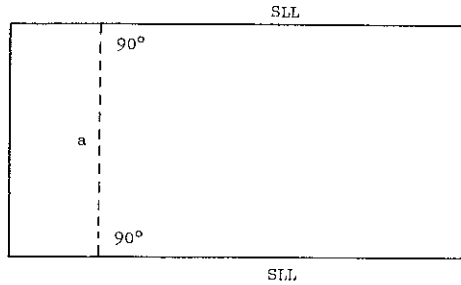

Average Lot Width is the perpendicular distance between Side Lot Lines (SLL)

(b) *Nonparallel Lot Lines.*

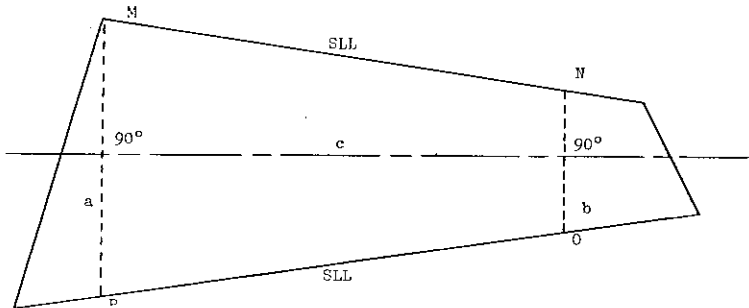

Average Lot Width is  $\frac{a + b}{2}$ , area of MINOP equals Minimum Lot Area and line c bisects angle formed by lines MN and OP extended.

(c) *Nonparallel Lot Lines, Alternate 1.*

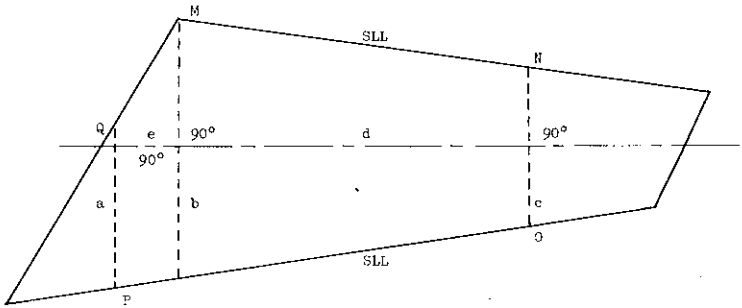

Average Lot Width is  $\frac{a + b}{2} \times \frac{e}{e + d} + \frac{b + c}{2} \times \frac{d}{e + d}$

Area of MNOPQ equals Minimum Lot Area and line d bisects angle formed by lines MN and OP extended. d is the perpendicular distance between lines b and c. e is the perpendicular distance between lines a and b.

(d) *Parallel Side Lot Lines, Alternate.*

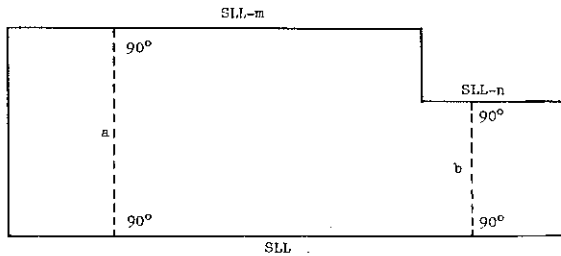

Average lot width is  $a \times \frac{m}{m + n} + b \times \frac{n}{m + n}$

Use only that part of length n that, when added to area of m portion of lot, satisfies minimum area requirements.



(e) *Nonparallel Lot Lines, Alternate 2.*

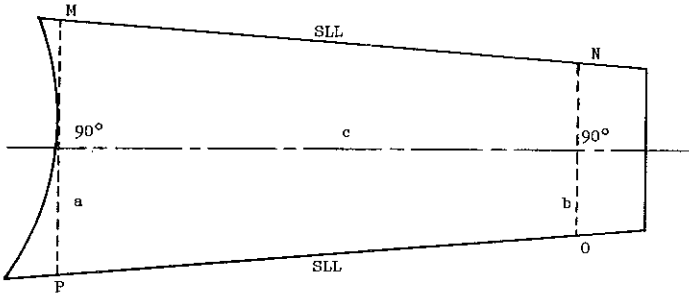

Average Lot Width is  $\frac{a + b}{2}$ , area of MNOP equals Minimum Lot area and line c bisects angle formed by lines MN and OP extended. c is the perpendicular distance between lines a and b.

(f) *Nonparallel Lot Lines, Alternate 3.*

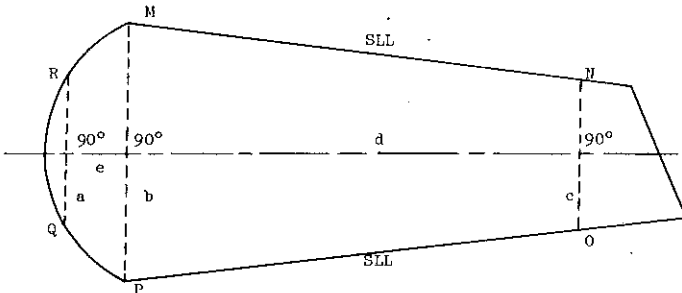

Average Lot Width is  $\frac{a + b}{2} \times \frac{e}{e + d} + \frac{b + c}{2} \times \frac{d}{e + d}$

Area of MNOPQR equals Minimum Lot Area and line d bisects angle formed by lines MN and OP extended. d is the perpendicular distance between b and c. e is the perpendicular distance between lines a and b.

(g) *Nonparallel Lot Lines, Alternate 4.*

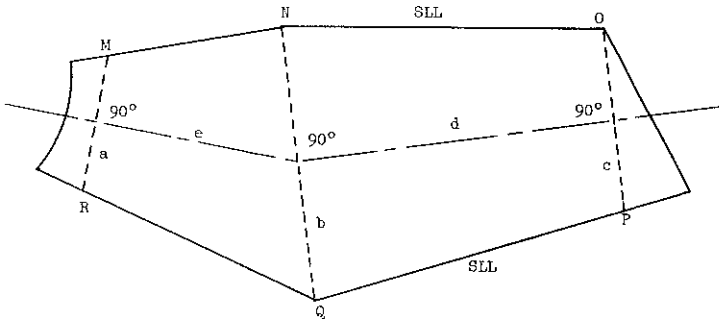

$$\text{Average Lot Width is } \frac{a + b}{2} \times \frac{e}{e + d} + \frac{b + c}{2} \times \frac{d}{e + d}$$

Area of MNPQR equals Minimum Lot Area, line e bisects angle formed by MN and QR extended and line d bisects angle formed by NO and PQ extended. d is the perpendicular distance between b and c. e is the perpendicular distance between a and b.

A 85.02 Department Review. The following narrative further describes the plat submittal procedures required by ch. 236, Stats.

#### SUBDIVIDING LANDS IN WISCONSIN—A SUMMARY OF CHAPTER 236, STATUTES

Divisions of land into smaller parcels are usually shown on the ground by means of some type of monument at each corner of the land parcel involved. These land parcels or divisions can be shown on drawings that are called plats. Creation of these parcels occurs when the plat is recorded by the Register of Deeds in the county in which the parcels are located. A state level subdivision is one means of creating land parcels and is defined in s. 236.02 (8), Stats. A land division is a state level subdivision if 5 or more parcels, each 1½ acres or less, are created within a 5 year period. Lower density land divisions can also be defined by local ordinances as being state level subdivisions. If a state level subdivision is proposed, 3 state agencies may have authority to either certify or object to plats of that subdivision. Each agency has specific limitations as to the scope of their review.

The department of development reviews plats of all state level subdivisions for conformity with the technical requirements in ch. 236, Stats., such as survey accuracy, monumentation and document preparation. As the lead state agency, they also coordinate the plat submittal process.

The department of transportation reviews plats of all state level subdivisions abutting state trunk highways, federal highways and interstate highways. Their review is based on conformity with ch. HY 33, Wis. Adm. Code, which covers number and location of street access points from subdivisions to highways.

The department of industry, labor and human relations reviews plats of all state level subdivisions not served by public sewers. This review is based on the requirements in this chapter — ILHR 85, Wis. Adm. Code.

In addition to review by the above state agencies, ch. 236, Stats., also mandates review by local units of government in which the proposal is located. If within a municipality, only the approval of the municipality is needed. If within the extraterritorial jurisdiction of a municipality, the approvals of the town and county are required and the approval of the municipality may be required. If outside extraterritorial jurisdiction, the approvals of the town and county are required. County planning agencies or county park commissions can also

have authority to object to these plats. Approving authorities must either reject or approve final plats within 60 days of receipt. No approvals can be issued until after all agencies having authority to object have certified that they have no objections to the proposal. No plat can be recorded until all approvals are obtained. None of the lots within the subdivision can be sold until after said recording.

Chapter 236, Stats., requires that one of the following 2 submittal procedures be followed. The subdivider or agent may submit the original plat to the approval authority for the unit of government, either a municipality or a town, in which the proposal is located. That authority then within 2 days makes copies and sends them to the department of development, to all other approving authorities, and to the county objection authority, if there is one. The department of development must then transmit copies to the other state agencies having review authority. All state agencies having review authority must then, within 20 days, either return one certified copy of the plat to the approving authority, or inform the subdivider and all approving or objecting authorities of any objections to the proposal.

In lieu of the above procedure, the subdivider or agent can submit the original plat to the department of development which then makes copies and sends them to all agencies having authority to object. Those agencies then have 20 days to either return one certified copy of the plat to the department of development, or inform the subdivider and all objecting authorities of any objections to the proposal. If there are no objections, the department of development returns the certified original to the subdivider or agent.

As per s. 236.13 (5), Stats., any person aggrieved by an objection to a plat or a failure to approve a plat may appeal therefrom as provided in s. 62.23 (7) (e) 10-15, Stats., within 30 days of notification of the rejection of the plat. Where the failure to approve is based on an unsatisfied objection, the agency making the objection shall be made a party to the action. The court shall direct that the plat be approved if it finds that the action of the approving authority or objecting agency is arbitrary, unreasonable or discriminatory.

Chapter 236, Stats., also allows municipalities, towns and counties to adopt land division ordinances which are more restrictive. For example, a county could require state and local level review of a land division creating more than 2 parcels, each of 10 acres or less, within 10 years. Also, ch. 236, Stats., does not require submittal of preliminary plats, but approving authorities can so require. The department of natural resources, although not an official reviewing authority, does have input in the plat review process. They do, upon request, advise the department of development of whether or not the requirements for public access in s. 236.16, Stats., have been met for subdivisions abutting navigable lakes or streams. Upon request they also advise the department of industry, labor and human relations of whether or not reported regional flood levels are correct.

#### DEPARTMENT OF INDUSTRY, LABOR AND HUMAN RELATIONS PLATTING PROGRAM

Formal action on subdivision plats can be taken by the department only if the copies of the plat are submitted in accordance with statutory requirements. In other words, the department is obliged to conduct a formal review and take formal action on copies of plats received *only* from the department of development. The department will comment informally on plats for other land divisions received from other sources, provided appropriate fees are received.

\* Chapter ILHR 85, Wis. Adm. Code, indicates in the first subchapter the conditions under which provision for public sewer service facilities can be considered as having been made. If such facilities are not provided, the regulations then establish minimum lot area and elevation requirements which are primarily based on soil and site characteristics.

The results of soil percolation tests conducted in accordance with the indicated procedure establish minimum lot area except in instances where detailed soil survey maps clearly show favorable soil permeability factors or where sandy soil conditions prevail. Soil percolation tests need not be conducted if the department waives the need for the tests and bases minimum lot area on detailed soil map information. If sandy soils prevail and lot layout is otherwise acceptable, percolation tests are not required. Minimum lot areas can be reduced by providing an approved community water supply or by use of lot combinations pending public sewer service.

The lot elevation requirements of ch. ILHR 85, Wis. Adm. Code, are related to the area requirements. Elevation standards are established for flooding, land slopes and depth to high groundwater, bedrock or soil with unacceptable percolation rates. The first subsection under the elevation requirements establishes the minimum area of each lot which must be free of all elevation limitations. These minimum continuous areas can be reduced if locations of soil absorption systems, and setbacks from buildings and wells are replanned on the plat. Flooding is evaluated on the basis of the regional flood elevation (100 year flood).

Groundwater is usually evaluated on the basis of estimated high groundwater levels using soil mottling. If groundwater, bedrock or permeability conditions are not clearly defined, a field investigation may be conducted to obtain necessary information.

One of the most important sections of ch. ILHR 85, Wis. Adm. Code, deals with obtaining soil boring and soil percolation test data. This section requires that a certified soil tester conduct the tests, indicates how the data is to be submitted, how many tests are required and how the tests are to be conducted.

A note is included in this chapter to signal that results of soil tests submitted in support of proposed subdivisions usually are not adequate in number for use in designing soil absorption systems on individual lots and that an adequate number of tests properly located must be conducted on each individual lot to obtain design information for soil absorption systems for septic tank effluent disposal.

**A 85.02 (6) Fees.** The following are the plat review fees from ch. Ind 69, Wis. Adm. Code.

**Ind 69.22 Platting-Subdivision Without Public Sewers. (1) APPLICATION.** The fees for department plat review and investigations of subdivisions not served by public sewers conducted in accordance with ch. ILHR 85, Wis. Adm. Code and ch. 236, Stats., shall be determined as follows:

(a) *Plat Reviews.* The fee for an initial plat submission shall be computed on the basis of \$20.00 per lot.

(b) *Resubmitted Plats.* The fee for a resubmitted plat shall be \$50.00 per plat.

(c) *Field Investigations.* The fee for any field investigation requested by the subdivider will be \$300.00 per day or fraction thereof per subdivision.

(d) *Groundwater Monitoring Review.* The fee for department review of groundwater monitoring data will be \$100 per subdivision.

(2) **COLLECTION OF FEES.** All fees shall be remitted to the department at the time that the plats are submitted for review or when field investigations are requested or conducted. No plat certifications will be made until the fees are received by the department.



## Chapter ILHR 86

### BOAT AND ON-SHORE SEWAGE FACILITIES

ILHR 86.01	Applicability (p. 447)	ILHR 86.07	Overboard discharge inactivation (p. 451)
ILHR 86.02	Definitions (p. 447)	ILHR 86.08	On-shore disposal facilities (p. 451)
ILHR 86.03	Petition for variance (p. 448)	ILHR 86.09	Alternate facilities (p. 452)
ILHR 86.04	Contract applicability (p. 448)	ILHR 86.10	Operation and maintenance (p. 452)
ILHR 86.05	Approval required (p. 448)	ILHR 86.11	Prohibited facilities (p. 452)
ILHR 86.06	Holding tank, toilet and appurtenances (p. 449)		

Note: Chapter H 80 as it existed on September 30, 1980 was repealed and a new chapter H 80 was created effective October 1, 1980; renumbered to be chapter ILHR 84 effective June 1, 1983; renumbered to be chapter ILHR 86 effective March 1, 1985.

**ILHR 86.01 Applicability.** This chapter as authorized by s. 30.71, Stats., for the abatement of water pollution through control of the discharge of sewage from boats maintained or operated at any time upon the inland or outlying waters of the state, defined in s. 29.01 (4), Stats., shall be applicable to any boat which is equipped with a toilet.

Note: Section 29.01 (4), Stats., provides: "All waters within the jurisdiction of the state are classified as follows: Lakes Superior and Michigan, Green Bay, Sturgeon Bay, Sawyer's harbor and the Fox river from its mouth up to the dam at De Pere are 'outlying waters.' All other waters, including the bays, bayous, and sloughs of the Mississippi river bottoms, are 'inland waters.'"

History: Cr. Register, September, 1980, No. 297, eff. 10-1-80; renum. from H 80.01, Register, May, 1983, No. 329, eff. 6-1-83.

**ILHR 86.02 Definitions.** The following definitions shall apply in the interpretation and enforcement of this chapter.

(1) "Department" means the department of industry, labor and human relations.

(2) "Approved" means written approval from the department.

(3) "Boat" means every description of watercraft, other than a seaplane, on the water, used or capable of being used as a means of transportation on water, s. 30.50 (1), Stats.

(4) "Deodorant" means a substance or process which masks or destroys offensive odor.

(5) "Holding tank" means a permanently installed container which receives the discharge from one toilet or more and retains the sewage for shore disposal.

(6) "Maintain and operate" means to moor and occupy or to navigate, steer, sail, row or otherwise to exercise physical control over the use or movement of a boat.

(7) "Owner" means the person who has lawful possession of a boat by virtue of legal title or equitable interest therein which entitles that person to such possession.

(8) "Portable toilet" means a self-contained unit with a flushing device which retains sewage in a holding tank for disposal to a sewage system acceptable to the department.

## ILHR 86

(9) "Recirculating system" means a holding tank with all necessary appurtenances to provide for the recirculation of flushing liquid and for the receiving, venting and shore removal of sewage.

(10) "Sealed" means making a toilet incapable of discharging sewage into the waters upon which a boat is operated or moored.

(11) "Sewage" means human body wastes.

(12) "Toilet" means any device, facility or installation designed or constructed for use as a place for receiving sewage directly from the human body.

History: Cr. Register, September, 1980, No. 297, eff. 10-1-80; renun. from H 80.02 and am. (1) Register, May, 1983, No. 329, eff. 6-1-83.

**ILHR 86.03 Petition for variance.** (1) **PROCEDURE.** The department shall consider and may grant a variance to an administrative rule upon receipt of a fee and a completed petition for variance form from the owner, provided an equivalent degree of safety is established in the petition for variance which meets the intent of the rule being petitioned. The department may impose specific conditions in a petition for variance to promote the protection of the health, safety and welfare of the employees or the public. Violation of those conditions under which the petition is granted constitutes a violation of these rules.

(2) **PETITION PROCESSING TIME.** Except for priority petitions, the department shall review and make a determination on a petition for variance within 30 business days of receipt of all calculations, documents and fees required to complete the review. The department shall process priority petitions within 10 business days.

Note: Copies of the petition for variance (form SBD-6690) are available from the Division of Safety and Buildings, P.O. Box 7969, Madison, Wisconsin 53707.

History: Cr. Register, September, 1980, No. 297, eff. 10-1-80; renun. from H 80.03, Register, May, 1983, No. 329, eff. 6-1-83; r. and recr. Register, October, 1984, No. 346, eff. 11-1-84; cr. (2), Register, February, 1985, No. 350, eff. 3-1-85.

**ILHR 86.04 Contract applicability.** Applicable provisions of this regulation shall be construed to be a part of any order or agreement, written or verbal, for the installation of a holding tank, recirculating system, provisions of a portable toilet or shore disposal facility or appurtenances thereto.

History: Cr. Register, September, 1980, No. 297, eff. 10-1-80; renun. from H 80.04, Register, May, 1983, No. 329, eff. 6-1-83.

**ILHR 86.05 Approval required.** (1) **GENERAL.** Any prefabricated tank, portable toilet or toilet proposed for installation in boats used upon the inland or outlying waters of the state shall receive the approval of the department. The manufacturer of any prefabricated tank, portable toilet or toilet shall submit, in duplicate, plans and specifications showing construction details for such facility. The owner of a custom built tank or toilet shall similarly submit such details in duplicate for approval prior to installation. The department may require the submission of other information or the unit itself, in the case of a portable toilet, to complete its review.

(2) **APPROVED UNIT LISTING.** The department shall keep a current list of approved prefabricated tanks, portable toilets and toilets for installation. Register, February, 1985, No. 350

tion on boats and shall provide a copy of such current list to the bureau of law enforcement, department of natural resources.

**History:** Cr. Register, September, 1980, No. 297, eff. 10-1-80; renurn. from H 80.05, Register, May, 1983, No. 329, eff. 6-1-83.

**ILHR 86.06 Holding tank, toilet and appurtenances.** (1) **MATERIAL.** Each holding tank and toilet shall be constructed of a plastic which is resistant to acid, alkali and water; stainless steel with comparable resistance or other approved material. Metal combinations shall be galvanically compatible.

(2) **HOLDING TANK STRENGTH.** A holding tank, with all openings sealed, shall show no signs of deformation, cracking or leakage when subjected to a combined suction and external pressure head of 5 pounds per square inch. It shall be designed and installed so as not to become permanently distorted with a static top load of 200 pounds.

(3) **TEMPERATURE RESISTANCE.** All materials used shall be capable of withstanding a temperature range of from -22° F. (winter storage) to the maximum operating temperature obtainable when operating in an ambient temperature of 140° F.

(4) **MOUNTING.** The tank and toilet shall be rigidly and permanently secured in place in such manner that the tank, toilet and piping will not fall.

(5) **CAPACITY.** The capacity shall be sufficient to receive the waste from the maximum number of persons that may be on board during an 8-hour period. The passenger rating shall be that indicated on the boat's capacity plate or that of a boat of similar size should the plate be illegible or missing.

(a) *Holding tank.* The capacity shall be determined on the basis of contribution of 4-½ gallons per person per 8-hour day for a toilet of the hand pump type. If standard waterflush toilets are installed, the minimum capacity shall be at 13-½ gallons per person per 8-hour day.

(b) *Recirculating toilet.* The capacity of the tank of a recirculating type unit shall be determined on the basis of a contribution of one-quarter gallon per person per 8-hour day.

(6) **CONTROLS.** Each holding tank shall contain a sewage level device which actuates a warning light or other visible gauge when the tank becomes three-fourths full. The light or other device shall be located so that it can be readily observed. The sewage level device shall be in operable condition at any time the boat is used. Such water level indicator shall be installed so as to be removable and be of such design and of such size as to make a watertight seal with a tank opening that is sufficiently large to accommodate the sewage level device.

(7) **MAINTENANCE.** (a) A separate manhole shall be provided in the top of the tank for maintenance purposes. A plate or cap capable of making a watertight seal shall be provided on the opening which shall be of sufficient size to readily permit cleaning and maintenance.

(b) *Deodorant.* Any deodorant used in a holding tank, approved portable toilet or recirculating toilet shall be easily obtainable and constitute a minimum hazard when handled, stored and used according to the manufacturer's recommendations and form no dangerous concentration of



gases nor react dangerously with other chemicals used for the same purpose.

(8) **OPENINGS FOR PIPING.** Openings shall be provided in each holding tank for inlet, outlet and vent piping. The openings and pipe fittings shall be so designed as to provide watertight joints between the tank and the piping. Plastic opening fittings shall be of the rigid serrated type. Inlet openings should preferably be such that they could accommodate fittings that would be connected to piping of a minimum nominal inside diameter (I.D.) of 1-½ inches. Outlet openings shall be such as to accommodate at least 1-½ inch I.D. piping. Vent pipe openings shall be able to accommodate fittings for at least a one-half inch I.D. pipe, and should preferably be located at the top of a conical frustum or cylindrical vertical extension of the tank which is at least 2 inches in diameter at the base and 2 inches or more in height.

(9) **PIPING AND FITTINGS.** (a) *Size.* The piping from a toilet to the holding tank shall be at least as large as the trap of the toilet fixture. The piping from the holding tank or toilet to the pumpout connection shall have a nominal inside diameter of at least one and one-half inches.

(b) *Material.* All waste and venting piping shall be made of galvanized steel, wrought iron or yoloy pipe; lead; brass; type M copper; or flexible or rigid plastic pipe. Assembly shall be made with threaded fittings in the case of ferrous or brass pipe; lead or solder type fittings in the case of lead and copper pipe; and with threaded fittings, insertible clamp type fittings or weldable fittings in the case of plastic pipe. Clamps, usable only with plastic pipe, shall be made of stainless steel. All piping materials and fittings shall be capable of withstanding a pressure of at least 75 pounds per square inch and a combined maximum suction and external pressure head equivalent to 50 feet of water.

(c) *Location.* No piping, other than that for venting, associated with the boat sewage system shall pass through the hull. The vent pipe shall terminate with an inverted U-bend, the opening of which shall be above the maximum water level in the toilet or holding tank. At least one vent terminal shall be constantly open to the atmosphere. The terminal of the outlet pipe shall be of the female connection type and be located above the holding tank in a manner that makes gravity discharge of the contents impractical. It shall have an airtight capping device marked "WASTE" and the cap and flange shall be embossed with the word "WASTE".

(10) **ELECTRICAL SYSTEM.** The electrical system associated with the boat holding tank or toilet system shall conform to accepted practice and create no hazards.

(11) **PORTABLE TOILET.** Each portable toilet shall meet the material requirements and temperature resistance requirements of subs. (1) and (3). Exposed surfaces shall be of reasonably smooth and cleanable material. Capacity of the flush tank and holding tank shall be adequate for the intended use. Portable toilets shall be designed to prevent spillage of contents of the holding tank when the toilet is tipped or portable toilets shall be secured on board.

**ILHR 86.07 Overboard discharge inactivation.** No boat equipped with a means of discharging sewage directly from a toilet or holding tank into the water upon which the boat is moored or is moved shall enter inland or outlying waters of the state until such means of discharge is inactivated. An owner or operator of a boat equipped with such means of discharge shall contact a representative of the department of natural resources or a local law enforcement official with respect to inactivation before entering state waters. Overboard discharge inactivation shall include as a minimum either disconnection of the toilet piping, removal of the pumping device, securely plugging the discharge outlet, sealing of the toilet bowl with wax or other method approved by the official contacted. The inspecting official shall provide the boat owner or operator with a signed written statement as to the method of inactivation accepted. The owner or operator shall give information as to the inland or outlying waters he plans to navigate and as to the time of stay on such waters.

Note: Discharge of wastes from boats in any form would be contrary to s. 29.29 (3), Stats.

History: Cr. Register, September, 1980, No. 297, eff. 10-1-80; renum. from H 80.07, Register, May, 1983, No. 329, eff. 6-1-83.

**ILHR 86.08 On-shore disposal facilities.** (1) **PUMP.** A self-priming pump, suitable for pumping sewage, shall be provided for the on-shore removal of sewage from boat holding tanks and toilets; the installation of which shall be in accord with the appropriate state and local regulations. Head characteristics and capacity shall be based on installation needs for the site. The pump may be either fixed in position or portably mounted.

(2) **SUCTION HOSE.** The suction hose shall be of non-collapsible quality, preferably made with reinforcement. A quick-connect dripproof connector shall be fitted to the end of the hose that is attached to the boat piping outlet.

(3) **DISCHARGE HOSE.** Quality flexible hose, compatible with the pump characteristics, may be used. All permanent piping shall conform to the state plumbing regulations. [chs. ILHR 82 and 84]

(4) **SEWAGE DISPOSAL REQUIREMENTS.** (a) *Public facilities.* When connection to a public sanitary sewer is economically feasible, the disposal piping shall be designed to discharge thereto. [ch. ILHR 84]

(b) *Private facilities.* When a public sewer is not available, a private sewage disposal system installed in compliance with applicable state plumbing regulations shall be provided unless adequate private treatment and disposal facilities are already available. [chs. ILHR 82 and 83]

(5) **WATER SUPPLY REQUIREMENTS.** The on-shore disposal facility shall be served by a water supply piping system to permit flushing of the facilities serviced. If a potable water supply is the source for flushing, the distribution piping shall be protected from backsiphonage and backpressure.

(6) **PLAN APPROVAL.** Every owner, personally or through an authorized representative, shall obtain written approval from the department prior to award of any new or modified construction of shore disposal facilities set forth in this section. Three sets of plans and specification of such new or modified shore disposal facilities to be constructed for the purpose of pumping out boat holding tanks and toilets, receiving sewage from portable toilets, and disposing of the sewage shall be submitted to the department for review as to acceptability. Plans and specifications

shall cover in detail the materials to be used, the pump characteristics, the water supply system, and when applicable, the size and construction of the septic or holding tank, results of soil percolation and boring tests and layout of the soil absorption system. Location of all wells within 50 feet of the absorption system, the surface water high water level and the general topography of the area shall be shown on the plans.

(7) **DISPOSAL OF PORTABLE TOILET WASTES.** Sewage from portable toilets shall be discharged into an approved fixture or other approved device designed to receive sewage.

History: Cr. Register, September, 1980, No. 297, eff. 10-1-80; renum. from H 80.08, Register, May, 1983, No. 329, eff. 6-1-83.

**ILHR 86.09 Alternate facilities.** (1) **CHEMICAL TYPE TOILETS.** Nonrecirculating chemical toilets may be used in lieu of a toilet flushed by water provided the container is not portable and the use of on-shore pumping facilities is provided for in the design of the unit. The design of the toilet and on-shore disposal adaptation shall be approved.

(2) **INCINERATOR TYPE TOILETS.** An approved incinerator type toilet may be used in lieu of a toilet flushed by water provided it is of adequate capacity to handle the passenger load. Equipment for on-shore removal and disposal of resulting ash shall be kept on board.

(3) **PORTABLE TOILETS.** An approved portable toilet may be used in lieu of a permanently installed toilet provided it is of adequate capacity to handle the passenger load. Sewage in the holding tank shall be properly disposed of on shore. Units shall be temporarily secured on board, if necessary, to prevent spillage of contents.

History: Register, September, 1980, No. 297, eff. 10-1-80; renum. from H 80.09, Register, May 1983, No. 329, eff. 6-1-83.

**ILHR 86.10 Operation and maintenance.** All facilities controlled by this chapter shall be maintained in good operating condition at all times. All necessary tools for repair and maintenance shall be kept on board or on dock, as the case may be, and shall be properly stored when not in use. Extra fuses for electrical equipment and extra indicator lights shall be on hand. Pump-out suction hoses should be adequately drained through the pump before disconnection and then properly stored or capped. Pumping equipment shall be shut off before the hose is disengaged from the boat outlet pipe. Any equipment on board shall not be used or operated to allow discharge of sewage to surface waters.

History: Cr. Register, September, 1980, No. 297, eff. 10-1-80; renum. from H 80.10, Register, May, 1983, No. 329, eff. 6-1-83.

**ILHR 86.11 Prohibited facilities.** No person shall use or permit to be used as a holding facility for sewage a pail, plastic bag or any other type of portable, semiportable or disposal receptacle aboard boats not specifically permitted by the provisions of this chapter.

History: Cr. Register, September, 1980, No. 297, eff. 10-1-80; renum. from H 80.11, Register, May, 1983, No. 329, eff. 6-1-83.