

Chapter Comm 81

DEFINITIONS AND STANDARDS

Comm 81.01 Definitions.

Comm 81.20 Incorporation of standards by reference.

Comm 81.01 Definitions. In chs. Comm 81 to 87, except as otherwise specifically defined:

- (1) "Accepted engineering practice" means a specification, standard, guideline or procedure in the field of plumbing or related thereto, generally recognized and accepted as authoritative documented through national standards or specifications.
- (2) "Accessible" when applied to a fixture, appliance, pipe, fitting, valve or equipment, means having access for maintenance, but which first may require the removal of an access panel or similar obstruction.
- (2m) "Accessory building" means a detached building, not used as a dwelling unit but is incidental to that of the dwelling.
- (3) "Aerobic treatment component" means a unit for the treatment of wastewater that utilizes the principle of oxidation for biological decomposition.
- (4) "Agent" means an individual or agency recognized by the department to act on the department's behalf relative to a specific activity or function.
- (5) "Air-break" means a piping arrangement for a drain system where the wastes from a fixture, appliance, appurtenance or device discharge by means of indirect or local waste piping terminating in a receptor at a point below the flood level rim of the receptor and above the outlet of the trap serving the receptor.
- (6) "Air-gap, drain system" means the unobstructed vertical distance through the free atmosphere between the outlet of indirect or local waste piping and the flood level rim of the receptor into which it discharges.
- (7) "Air-gap, water supply system" means the unobstructed vertical distance through the free atmosphere between the lowest opening from any pipe or faucet supplying water to a tank or plumbing fixture and the flood level rim or spill level of the receptacle.
- (7e) "Alternate plumbing system" means a type of plumbing system designed in such a manner that valid and reliable data shall demonstrate to the department that the plumbing system is in compliance with the intent of chs. Comm 81 to 84.
- (7m) "Ambulatory surgery center" means a health care facility that accepts federal funding in accordance with 42 CFR 416 of the federal register for health care finance and where 4 or more individuals that undergo a surgical procedure for which federal reimbursement is based.
- (8) "Anaerobic treatment component" means a unit for the treatment of wastewater which utilizes molecular oxygen in the absence of free oxygen for biological respiration and decomposition.
- (9) "Approved" means acceptance documented in writing by the department.
- (10) "Appurtenance" means a manufactured device or prefabricated assembly of component parts which is an adjunct to a plumbing product or plumbing system.
- (11) "Area drain" means a receptor designed to collect storm waters from an open area.
- (12) "Areawide water quality management plan" means those plans prepared by the department of natural resources, including those plans prepared by agencies designated by the governor under the authority of ss. 281.11, 281.12 (1), 281.15, and 283.83, Stats., for the purpose of managing, protecting and enhancing groundwater and surface water of the state.
- Note: See ch. Comm 82 Appendix for a list of water quality management agencies and their addresses.
- (13) "Aspirator" means a fitting or device supplied with water or other fluid under positive pressure which passes through an integral orifice or constriction causing a vacuum.
- (14) "Autopsy table" means a fixture or table used for post-mortem examination.
- (15) "Automatic fire sprinkler system" has the meaning specified under s. 145.01 (2), Stats.
- Note: Section 145.01 (2), Stats., reads: "Automatic fire sprinkler system", for fire protection purposes, means an integrated system of underground and overhead piping designed in accordance with fire protection engineering standards. The system includes a suitable water supply, such as a gravity tank, fire pump, reservoir or pressure tank or connection beginning at the supply side of an approved gate valve located at or near the property line where the pipe or piping system provides water used exclusively for fire protection and related appurtenances and to standpipes connected to automatic sprinkler systems. The portion of the sprinkler system above ground is a network of specially sized or hydraulically designed piping installed in a building, structure or area, generally overhead, and to which sprinklers are connected in a systematic pattern. The system includes a controlling valve and a device for actuating an alarm when the system is in operation. The system is usually activated by heat from a fire and discharges water over the fire area.
- (16) "Backflow" means the unwanted reverse flow of liquids, solids or gases.
- (17) "Back pressure" means a pressure greater than the supply pressure that may cause backflow.
- (17e) "Backflow preventer" means any generic backflow prevention device or assembly.
- (18) "Backflow preventer with intermediate atmospheric vent" means a type of cross connection control device which consists of 2 independently acting check valves, internally force-loaded to a normally closed position and separated by an intermediate chamber with a means for automatically venting to atmosphere where the venting means is internally force-loaded to a normally open position. The terms "backflow preventer" or "dual check valve type with atmospheric port backflow preventer" has the same meaning as backflow preventer with intermediate atmospheric vent.
- (19) "Back siphonage" means the creation of a backflow as a result of negative pressure.
- (21) "Backwater valve" means a device designed to prevent the reverse flow of wastewater in a drain system.
- (22) "Ballcock" means a water supply valve opened or closed by means of a float or similar device used to supply water to a tank.
- (23) "Bathroom group" means a water closet, lavatory and a bathtub or shower located together on the same floor level.
- (24) "Battery of fixtures" means any group of 2 or more fixtures that discharge into the same horizontal branch drain.
- (25) "Bedpan sterilizer" means a fixture used for sterilizing bedpans or urinals by direct application of steam, boiling water or chemicals.
- (26) "Bedpan washer and sanitizer" means a fixture designed to wash bedpans and to flush the contents into the sanitary drain system and which may also provide for disinfecting utensils by scalding with steam or hot water.
- (27) "Bedpan washer hose" means a device supplied with hot or cold water, or both, and located adjacent to a water closet or clinical sink to be used for cleansing bedpans.

(28) "Bedrock" means rock that is exposed at the earth's surface or underlies soil material and includes:

(a) Weathered in-place consolidated material, larger than 2 mm in size and greater than 50% by volume; and

(b) Weakly consolidated sandstone at the point of increased resistance to penetration of a knife blade.

(29) "Bell" means the portion of a pipe that is enlarged to receive the end of another pipe of the same diameter for the purpose of making a joint.

(30) "Bench mark" or "BM" means a permanently established point, the elevation of which is assumed or known, which serves as a vertical reference point, and which may also serve as a horizontal reference point.

(31) "Blackwater" means wastewater contaminated by human body waste, toilet paper and any other material intended to be deposited in a receptor designed to receive urine or feces.

(32) "BOD₅" or "biochemical oxygen demand 5 day" means a measure of the amount of biodegradable organic matter in water.

(33) "Boiler blow-off basin" means a vessel designed to receive the discharge from a boiler blow-off outlet and to cool the discharge to a temperature that permits safe entry into the drain system.

(34) "Branch" means a part of a piping system other than a riser, main or stack.

(35) "Branch interval" means the vertical distance along a drain stack measured from immediately below a branch drain connection to immediately below the first lower branch drain connection that is 8 feet or more below.

Note: See ch. Comm 82 Appendix for an illustration depicting branch intervals.

(35m) "Branch tailpiece" means a fitting consisting of a combination tail piece and a wye.

(36) "Branch vent" means a vent serving more than one fixture drain.

(37) "B.T.U." means British Thermal Units.

(38) "Building" means a structure for support, shelter or enclosure of persons or property.

(39) "Building drain" means horizontal piping within or under a building, installed below the lowest fixture or the lowest floor level from which fixtures can drain by gravity to the building sewer.

(40) "Building drain branch" means a fixture drain which is individually connected to a building drain and is vented by means of a combination drain and vent system.

(41) "Building drain, sanitary" means a building drain which conveys wastewater consisting in part of domestic wastewater.

(42) "Building drain, storm" means a building drain which conveys storm water, clear water, or both.

(43) "Building permit" means any written permission from a municipality that allows construction to commence on a structure.

(44) "Building sewer" means that part of the drain system not within or under a building which conveys its discharge to a public sewer, private interceptor main sewer, private onsite wastewater treatment system or other point of discharge or dispersal.

(45) "Building sewer, sanitary" means a building sewer which conveys wastewater consisting in part of domestic wastewater.

(46) "Building sewer, storm" means a building sewer which conveys storm water, clear water, or both.

(47) "Building subdrain" means the horizontal portion of a drain system which does not flow by gravity to the building sewer.

(48) "Building subdrain branch" means a fixture drain which is individually connected to a building subdrain and is vented by means of a combination drain and vent system.

(49) "Burr" means a roughness or metal protruding from the walls of a pipe usually as the result of cutting the pipe.

(50) "Business establishment" means any industrial or commercial organization or enterprise operated for profit, including

but not limited to a proprietorship, partnership, firm, business trust, joint venture, syndicate, corporation or association.

(51) "Camping unit transfer container" means a type of stationary holding tank used to collect and hold wastewater discharges generated by an individual camping trailer or recreational vehicle.

(51m) "Campsite receptor" means the vertical drain piping and trap combination that receives wastewater from recreational vehicles.

(52) "Catch basin" means a watertight receptacle built to arrest sediment of surface, subsoil or other waste drainage, and to retain oily or greasy wastes, so as to prevent their entrance into the building drain or building sewer.

(53) "Cesspool" means an excavation which receives domestic wastewater by means of a drain system without pretreatment of the wastewater and retains the organic matter and solids permitting the liquids to seep from the excavation.

(54) "Circuit vent" means a method of venting 2 to 8 traps or trapped fixtures without providing an individual vent for each trap or fixture.

(55) "Cleanout" means an accessible opening in a drain system used for the removal of obstructions.

(56) "Clear water" means wastewater other than storm water, having no impurities or where impurities are below a minimum concentration considered harmful by the department, including but not limited to noncontact cooling water and condensate drainage from refrigeration compressors and air conditioning equipment, drainage of water used for equipment chilling purposes and cooled condensate from steam heating systems or other equipment.

(56e) "Clinic sink" means a fixture having an integral trap and a flushing rim so that water cleanses the interior surface.

Note: This fixture has flushing and cleansing characteristics similar to a water closet. A clinic sink may also be referred to as a clinic service sink, a bedpan washing sink or a flushing rim sink.

(57) "Cold water" means water at a temperature less than 85°F.

(58) "Combination fixture" means a fixture combining one sink and laundry tray or a 2- or 3-compartment sink or laundry tray in one unit.

(59) "Combination drain and vent system" means a specially designed system of drain piping embodying the wet venting of one or more fixtures by means of a common drain and vent pipe adequately sized to provide free movement of air in the piping.

(59m) "Combination private water main" means a private water main that serves a fire protection system and any number of plumbing fixtures.

(59s) "Combination water service" means a water service that serves a fire protection system and any number of plumbing fixtures.

(60) "Common vent" means a branch vent connecting at or downstream from the junction of 2 fixture drains and serving as a vent for those fixture drains.

(60e) "Community-based residential facility" has the meaning specified under s. 50.01 (1g), Stats.

Note: Section 50.01 (1g), Stats., reads: "Community-based residential facility" means a place where 5 or more adults who are not related to the operator or administrator and who do not require care above intermediate level nursing care reside and receive care, treatment or services that are above the level of room and board but that include no more than 3 hours of nursing care per week per resident. "Community-based residential facility" does not include any of the following:

(a) A convent or facility owned or operated by members of a religious order exclusively for the reception and care or treatment of members of that order.

(b) A facility or private home that provides care, treatment and services only for victims of domestic abuse, as defined in s. 46.95 (1) (a), Stats., and their children.

(c) A shelter facility as defined under s. 560.9808 (1) (d), Stats.

(d) A place that provides lodging for individuals and in which all of the following conditions are met:

1. Each lodged individual is able to exit the place under emergency conditions without the assistance of another individual.

2. No lodged individual receives from the owner, manager or operator of the place or the owner's, manager's or operator's agent or employee any of the following:

a. Personal care, supervision or treatment, or management, control or supervision of prescription medications.

b. Care or services other than board, information, referral, advocacy or job guidance; location and coordination of social services by an agency that is not affiliated with the owner, manager or operator, for which arrangements were made for an individual before he or she lodged in the place; or, in the case of an emergency, arrangement for the provision of health care or social services by an agency that is not affiliated with the owner, manager or operator.

(e) An adult family home.

(f) A residential care apartment complex.

(g) A residential facility in the village of Union Grove that was authorized to operate without a license under a final judgment entered by a court before January 1, 1982, and that continues to comply with the judgment notwithstanding the expiration of the judgment.

(61) "Conductor" means a drain pipe inside the building which conveys storm water from a roof to the storm drain or storm sewer.

(61m) "Containment" means the installation of a cross connection control method, device or assembly to prohibit the flow of contamination from a building or facility into a water supply system.

(62) "Contaminant load" means the concentrations of substances in a wastewater stream.

(62m) "Continuous pressure" means a pressure greater than atmospheric and exerted for a period of more than 12 continuous hours.

(62s) "Conveyance system" means that portion of a drain system that consists of a series of pipes that transport water from one area to another without providing detention.

(63) "Corporation cock" means a valve:

(a) Installed in a private water main or a water service at or near the connection to a public water main; or

(b) Installed in the side of a forced main sewer to which a forced building sewer is connected.

(64) "Critical level" means the reference point on a vacuum breaker that must be submerged before backflow can occur. When the critical level is not indicated on the vacuum breaker, the bottom of the vacuum breaker shall be considered the critical level.

(65) "Cross connection" means a connection or potential connection between any part of a water supply system and another environment containing substances in a manner that, under any circumstances, would allow the substances to enter the water supply system by means of back siphonage or back pressure.

(65m) "Cross connection control assembly" means a testable backflow preventer consisting of an arrangement of components.

(66) "Cross connection control device" means any mechanical device which automatically prevents backflow from a contaminated source into a potable water supply system.

(67) "Curb stop" means a valve placed in a water service or a private water main, usually near the lot line.

(68) "Dead end" means a branch leading from a drain pipe, vent pipe, building drain or building sewer and terminating at a developed length of 2 feet or more by means of a plug, cap or other closed fitting.

(69) "Department" means the department of commerce.

(70) "Design wastewater flow" means 150% of the estimated wastewater flow generated by a dwelling, building or facility.

(70m) "Detention" means the collection and temporary storage of water for subsequent gradual discharge.

(71) "Determination of failure" has the meaning specified under s. 145.245 (1) (a), Stats.

Note: Section 145.245 (1) (a), Stats., reads:

"Determination of failure" means any of the following:

1. A determination that a private sewage system is failing, according to the criteria under sub. (4), based on an inspection of the private sewage system by an employee of the state or a governmental unit who is certified to inspect private sewage systems by the department.

2. A written enforcement order issued under s. 145.02 (3) (f), 145.20 (2) (f) or 281.19 (2).

3. A written enforcement order issued under s. 254.59 (1) by a governmental unit.

(72) "Developed length" means the length of pipe line measured along the centerline of the pipe and fittings.

(72e) "Dfu" means drainage fixture unit.

(73) "Diameter" means in reference to a pipe the nominal inside diameter of the pipe.

(74) "Disinfection unit" means a type of POWTS treatment component, excluding a soil-based POWTS treatment component, that utilizes a chemical or photoelectric process to reduce the wastewater fecal coliform contaminant load.

(75) "Dispersal zone" means a dimensional volume of in situ soil that receives wastewater for treatment or distributes final effluent for dispersal.

(76) "Distribution cell" means a dimensional zone that is part of a POWTS treatment or dispersal component where wastewater is disseminated into in situ soil or engineered soil.

(77) "Documented data" means data which is developed in accordance with scientifically valid analytical protocols including field trials where appropriate, is subjected to peer review, results from more than one study, and consistent with other credible research.

(78) "Domestic wastewater" means the type of wastewater, not including storm water, normally discharged from or similar to that discharged from plumbing fixtures, appliances and devices including, but not limited to sanitary, bath, laundry, dishwashing, garbage disposal and cleaning wastewaters.

(79) "Double check backflow prevention assembly" means a type of cross connection control assembly which is composed of 2 independently acting check valves internally force-loaded to a normally closed position, tightly closing shut-off valves located at each end of the assembly and fitted with test cocks. The term "double check valve backflow preventer" has the same meaning as double check backflow prevention assembly.

(80) "Double check detector fire protection backflow preventer-assembly" means an assembly serving a fire protection system and consisting of 2 independently acting check valves, internally forced loaded to a normally closed position, 2 tightly closing shut-off valves, and properly located test cocks which also includes a parallel flow meter to indicate leakage or unauthorized use of water downstream of the assembly.

(80m) "Double check fire protection backflow prevention assembly" means an assembly serving a fire protection system and consisting of 2 independently acting check valves, internally forced loaded to a normally closed position, 2 tightly closing shut-off valves, and properly located test cocks. The term "double check valve backflow preventer for fire protection systems" has the same meaning as double check fire protection backflow prevention assembly.

(81) "Drain" means any pipe that carries wastewater or water-borne wastes.

(82) "Drain system" includes all the piping or any portion of the piping within public or private premises which conveys wastewater to a legal point of disposal, but does not include the mains of public sewer systems or a private onsite wastewater treatment system or public sewage treatment or disposal plant.

(82e) "Dual check backflow preventer wall hydrant-freeze resistant type" means a type of hose bibb that provides protection of the potable water supply from contamination due to backsiphonage or backpressure without damage to the device due to freezing, and is field testable to verify protection under the high hazard conditions present at a hose threaded outlet.

(82m) "Dual check valve type with atmospheric port backflow preventer" has the same meaning as specified in sub. (18).

(83) "Dwelling" means a structure, or that part of a structure, which is used or intended to be used as a home, residence or sleeping place by one person or by 2 or more persons maintaining a common household, to the exclusion of all others.

(84) "Effluent" means liquid discharged from a process, device, appurtenance or piping system.

(85) "Ejector" means an automatically operated device to elevate wastewater by the use of air under higher than atmospheric pressure.

(86) "Elevation" or "EL" means the vertical distance from the datum to a point under investigation.

(87) "Enforcement standard" or "ES" has the meaning specified under s. 160.01 (2), Stats.

Note: Section 160.01 (2), Stats., reads:
"Enforcement standard" means a numerical value expressing the concentration of a substance in groundwater which is adopted under ss. 160.07 and 160.09.

(88) "Engineered soil" means a mineral product that is equivalent to in situ soil for which treatment capability has been credited under Table 83.44-3, or superior to in situ soil in its ability to treat or disperse domestic wastewater from a POWTS.

(89) "Engineered system" means a system designed to meet the intent of the code but not the enumerated specifications of the state plumbing code.

(90) "Estimated wastewater flow" means the typical quantity of domestic wastewater generated daily by a dwelling, building or facility.

(90e) "Experimental plumbing system" has the same meaning as experimental system as specified in sub. (91).

(90m) "Exam sink" means a plumbing fixture used for hand washing in health care and related facilities.

Note: An exam sink may also be referred to as a treatment sink.

(91) "Experimental system" means a type of plumbing system from which valid and reliable data are being sought to demonstrate compliance with the intent of chs. Comm 82 to 84.

(92) "Failing private onsite wastewater treatment system" has the meaning specified under s. 145.245 (4), Stats.

Note: Section 145.245 (4) reads:
"Failing private sewage system" means a private sewage system which causes or results in any of the following conditions:

- (a) The discharge of sewage into surface water or groundwater.
- (b) The introduction of sewage into zones of saturation which adversely affects the operation of a private sewage system.
- (c) The discharge of sewage to a drain tile or into zones of bedrock.
- (d) The discharge of sewage to the surface of the ground.
- (e) The failure to accept sewage discharges and backup of sewage into the structure served by the private sewage system.

(93) "Farm" means a parcel of 35 or more acres of contiguous land that is devoted primarily to agricultural use, as defined under s. 91.01 (1) and (5), Stats.

Note: Section 91.01 (1) and (5), Stats., read:

(1) "Agricultural use" means beekeeping; commercial feedlots; dairying; egg production; floriculture; fish or fur farming; forest and game management; grazing; livestock raising; orchards; plant greenhouses and nurseries; poultry raising; raising of grain, grass, mint and seed crops; raising of fruits, nuts and berries; sod farming; placing land in federal programs in return for payment in kind; owning land, at least 35 acres of which is enrolled in the conservation reserve program under 16 USC 3831 to 3836; participating in the milk production termination program under 7 USC 1446 (d); and vegetable raising.

(5) "Devoted primarily to agricultural use" means under agricultural use for at least 12 consecutive months during the preceding 36-month period.

(94) "Faucet" means a valve end of a water pipe by means of which water can be drawn from or held within the pipe.

(95) "Final effluent" means the effluent from the last POWTS treatment component.

(96) "Fixture drain" means the drain from a fixture to a junction with another drain pipe.

(97) "Fixture supply" means that portion of a water distribution system serving one plumbing fixture, appliance or piece of equipment.

(98) "Fixture supply connector" means that portion of water supply piping which connects a plumbing fixture, appliance or a piece of equipment to the water distribution system.

(99) "Fixture unit, drainage" or "dfu" means a measure of the probable discharge into the drain system by various types of plumbing fixtures. The drainage fixture unit value for a particular

fixture depends on its volume rate of drainage discharge, on the time duration of a single drainage operation, and on the average time between successive operations.

(100) "Fixture unit, supply" or "sfu" means a measure of the probable hydraulic demand on the water supply by various types of plumbing fixtures.

Note: The supply fixture unit value for a particular fixture depends on its volume rate of supply, on the time duration of a single supply operation, and on the average time between successive operations.

(101) "Floodfringe" has the meaning specified under s. NR 116.03 (14).

Note: Section NR 116.03 (14) reads: "Floodfringe" means that portion of a floodplain which is outside of the floodway, which is covered by flood water during the regional flood. The term "floodfringe" is generally associated with standing water rather than flowing water.

(102) "Flood level rim" means the edge of the receptacle from which water overflows.

(103) "Floodplain" has the meaning specified under s. NR 116.03 (16).

Note: Section NR 116.03 (16) reads:
"Floodplain" means that land which has been or may be covered by flood water during the regional flood. The floodplain includes the floodway, floodfringe, shallow depth flooding, flood storage and coastal floodplain areas.

(104) "Floodway" has the meaning specified under s. NR 116.03 (22).

Note: Section NR 116.03 (22) reads:
"Floodway" means the channel of a river or stream, and those portions of the floodplain adjoining the channel required to carry the regional flood discharge.

(105) "Floor sink" means a receptor for the discharge from indirect or local waste piping installed with its flood level rim even with the surrounding floor.

(106) "Flow" means the volumetric measure of a liquid stream in a specified time.

(107) "Flushometer valve" means a device which discharges a predetermined quantity of water to fixtures for flushing purposes and is closed by direct water pressure.

(108) "Flush valve" means a device located at the bottom of a tank for flushing water closets and similar fixtures.

(108m) "Foundation drain" means a subsoil drain that serves the area of the foundation of a building.

(108s) "Freeze resistant sanitary yard hydrant" means a type of device serving as a hose bibb that has design features that minimize the risk of freezing, prevent groundwater contamination and provide backflow protection. The term "freeze resistant sanitary yard hydrant with backflow protection" has the same meaning as freeze resistant sanitary yard hydrant.

(109) "Garage, private" means a building or part of a building used for the storage of vehicles or other purposes, by a family or less than 3 persons not of the same family and which is not available for public use.

(110) "Garage, public" means a building or part of a building which accommodates or houses self-propelled land, air or water vehicles for 3 or more persons not of the same family.

(111) "Governmental unit" has the meaning specified under s. 145.01 (5), Stats.

Note: Section 145.01 (5), Stats., reads:
"Governmental unit responsible for the regulation of private sewage systems" or "governmental unit", unless otherwise qualified, means the county, except that in a county with a population of 500,000 or more these terms mean the city, village or town where the private sewage system is located.

(112) "Graywater" means wastewater contaminated by waste materials, exclusive of urine, feces or industrial waste, deposited into plumbing drain systems.

(113) "Grease interceptor" means a receptacle designed to intercept and retain or remove grease or fatty substances.

(114) "Groundwater" has the meaning specified under s. 160.01 (4), Stats.

Note: Section 160.01 (4), Stats., reads:
"Groundwater" means any of the waters of the state, as defined under s. 281.01 (18), occurring in a saturated subsurface geological formation of rock or soil.

(115) "Hand-held shower" means a hose and a hand-held discharge piece such as a shower head or spray connecting to a fixture fitting.

(116) "Health care and related facility" means a hospital, nursing home, community-based residential facility, county home, infirmary, inpatient mental health center, inpatient hospice, ambulatory surgery center, adult daycare center, end stage renal facility, facility for the developmentally disabled, institute for mental disease, urgent care center, clinic or medical office, child caring institution, or school of medicine, surgery or dentistry.

(117) "Health care plumbing appliance" means a plumbing appliance, the function of which is unique to health care activities.

(118) "High groundwater" means zones of soil saturation which include perched water tables, shallow regional groundwater tables or aquifers, or zones that are seasonally, periodically or permanently saturated.

(119) "High groundwater elevation" means the higher of either the elevation to which the soil is saturated when observed as a free water surface, or the elevation to which the soil has been seasonally or periodically saturated as indicated by the highest elevation of redoximorphic features in the soil profile.

(120) "High hazard" means a situation where the water supply system could be contaminated with a toxic substance or solution so as to make the water unsuitable for the designated use.

(121) "Holding tank" means a watertight receptacle for the collection and holding of wastewater.

(122) "Horizontal pipe" means any pipe or fitting which makes an angle of less than 45° with the horizontal.

(123) "Horizontal reference point" means a stationary, identifiable point to which horizontal dimensions can be related.

(124) "Hose connection backflow preventer" means a type of cross connection control device which consists of 2 independent checks, force-loaded or biased to a closed position, with an atmospheric vent located between the 2 check valves, which is force-loaded or biased to an open position, and a means for attaching a hose.

(125) "Hose connection vacuum breaker" means a type of cross connection control device which consists of a check valve member force-loaded or biased to a closed position and an atmospheric vent valve or means force-loaded or biased to an open position when the device is not under pressure.

(126) "Hot water" means water at a temperature of 110° F. or more.

(127) "Hot water storage tank" means a tank used to store water that is heated indirectly by a circulating water heater or by steam or hot water circulating through coils or by other heat exchange methods internal or external to the tank.

(128) "Human health hazard" has the meaning specified under s. 254.01 (2), Stats.

Note: Section 254.01 (2), Stats., reads:

"Human health hazard" means a substance, activity or condition that is known to have the potential to cause acute or chronic illness or death if exposure to the substance, activity or condition is not abated.

(129) "Hydrostatic test" means a test performed on a plumbing system or portion thereof in which the system is filled with a liquid, normally water, and raised to a designated pressure.

(130) "Indian lands" means lands owned by the United States and held for the use or benefit of Indian tribes or bands or individual Indians, and lands within the boundaries of a federally recognized reservation that are owned by Indian tribes or bands or individual Indians.

(131) "Indirect waste piping" means drain piping which does not connect directly with the drain system, but which discharges into the drain system by means of an air break or air gap into a receptor.

(132) "Individual vent" means a pipe installed to vent a fixture trap.

(133) "Industrial wastewater" means the liquid wastes that result from industrial processes.

(133s) "Infiltration component" means any device or method that is intended to promote the assimilation of water into in situ soil.

(134) "Infiltrative surface" means the plane within a treatment or dispersal component at which effluent is applied to in situ soil or engineered soil.

(135) "In situ soil" means soil naturally formed or deposited in its present location or position and includes soil material that has been plowed using normal tillage implements and depositional material resulting from erosion or flooding.

(136) "Interceptor" or "separator" means a device designed and installed so as to separate and retain deleterious, hazardous or undesirable matter from wastes flowing through it.

(136s) "Irrigation" means the application of water to the root zone of plants or plantings.

(137) "Laboratory faucet backflow preventer" means a type of cross connection control device which consists of 2 independently acting check valves force-loaded or biased to a closed position and, between the check valves, a means for automatically venting to atmosphere which is force-loaded or biased to an open position.

(138) "Laboratory plumbing appliance" means a plumbing appliance, the function of which is unique to scientific experimentation or research activities.

(139) "Leaching chamber" means a product designed to support soil and create a cavity for the temporary storage of effluent and to provide an infiltrative surface for the distribution cell POWTS dispersal or treatment component.

(140) "Leader" means a pipe or channel outside a building which conveys storm water from the roof or gutter drains to a storm drain, storm sewer or to grade.

(141) "Lead-free" mean a chemical composition equal to or less than 0.2% of lead.

(142) "Linear loading rate" means the amount of effluent applied daily along the landscape contour expressed in gallons per day per linear foot along a site contour.

(143) "Load factor" means the percentage of the total connected fixture unit flow rate which is likely to occur at any point in a drain system.

(144) "Local station" means a National Weather Service (NWS) precipitation station or other station accepted by the department as collecting precipitation data in accordance with NWS methods.

(145) "Local waste piping" means a portion of drain piping which receives the wastes discharged from indirect waste piping and which discharges those wastes by means of an air break or air gap into a receptor.

(146) "Local vent" means a pipe connecting to a fixture and extending to outside air through which vapor or foul air is removed from the fixture.

(147) "Low hazard" means a situation where the water supply system could be contaminated with a nontoxic substance or solution so as to make the water unsuitable for the designated use.

(148) "Main" means the principal pipe artery to which branches may be connected.

(149) "Manhole" means an opening constructed to permit access by a person to a sewer or any underground portion of a plumbing system.

(150) "Manufactured dwelling" has the meaning specified under s. Comm 20.07 (52) (a).

Note: Section Comm 20.07 (52) (a) was repealed.

Note: Under s. 101.71 (6) (a) Stats., "modular home" means any structure or component thereof which is intended for use as a dwelling and;

1. Is of closed construction and fabricated or assembled on-site or off-site in manufacturing facilities for installation, connection, or assembly and installation, at the building site; or

2. Is a building of open construction which is made or assembled in manufacturing facilities away from the building site for installation, connection, or assembly and installation, on the building site and for which certification is sought by the manufacturer.

(b) "Modular home" does not mean any manufactured home under s. 101.92 or any building of open construction which is not subject to par. (a) 2.

Note: See sub. (151) for the definition of a manufactured home.

(151) "Manufactured home" has the meaning specified under s. 101.91 (2), Stats.

Note: Section 101.91 (2), Stats., reads: "Manufactured home" means any of the following:

(am) A structure that is designed to be used as a dwelling with or without a permanent foundation and that is certified by the federal department of housing and urban development as complying with the standards established under 42 USC 5401 to 5425.

(c) A mobile home, unless a mobile home is specifically excluded under the applicable statute.

(152) "Manufactured home drain connector" means the pipe that joins the drain piping for a manufactured home to the building sewer.

(153) "Manufactured home community" has the meaning specified under s. 101.91 (5m), Stats.

Note: Section 101.91 (5m), Stats., reads: "Manufactured home community" means any plot or plots of ground upon which 3 or more manufactured homes that are occupied for dwelling or sleeping purposes are located. "Manufactured home community" does not include a farm where the occupants of the manufactured homes are the father, mother, son, daughter, brother or sister of the farm owner or operator or where the occupants of the manufactured homes work on the farm.

(154) "Mechanical joint" means a connection between pipes, fittings or pipes and fittings by means of a device, coupling, fitting or adapter where compression is applied around the center line of the pieces being joined, but which is not caulked, threaded, soldered, solvent cemented, brazed or welded.

(155) "Multiple dwelling" means a building containing more than 2 dwelling units.

(156) "Multipurpose piping system" means a water distribution system conveying water to plumbing fixtures and appliances and automatic fire sprinklers with the intention of serving both domestic and fire protection needs.

(157) "Municipality" means any city, village, town or county in this state.

(158) "Munsell soil color" means a color classification that specifies the relative degrees of the color variables in terms of hue, value and chroma.

(159) "Navigable waters" has the meaning specified under s. NR 115.03 (5).

Note: Section NR 115.03 (5) reads:

"Navigable waters" means Lake Superior, Lake Michigan, all natural inland lakes within Wisconsin and all streams, ponds, sloughs, flowages and other waters within the territorial limits of this state, including the Wisconsin portion of boundary waters, which are navigable under the laws of this state. Under s. 281.31 (2) (d), Stats., notwithstanding any other provision of law or administrative rule promulgated thereunder, shoreland ordinances required under s. 59.971, Stats., and this chapter do not apply to lands adjacent to farm drainage ditches if:

(a) Such lands are not adjacent to a natural navigable stream or river;

(b) Those parts of such drainage ditches adjacent to such lands were nonnavigable streams before ditching or had no previous stream history; and

(c) Such lands are maintained in nonstructural agricultural use.

(160) "Negative pressure" means a pressure less than atmospheric.

(160m) "Noncontinuous pressure" means a pressure greater than atmospheric and exerted for a period of no more than 12 continuous hours.

(161) "Nonpotable water" means water not safe for drinking, personal or culinary use.

(162) "Nonpublic" means, in the classification of plumbing fixtures, those fixtures in residences, apartments, living units of hotels and motels, and other places where the fixtures are intended for the use by a family or an individual to the exclusion of all others.

(163) "Nontoxic" means a substance in the diluted form that meets one of the following requirements:

(a) Is listed by the National Sanitation Foundation (NSF) as meeting the NSF evaluation criteria for nonfood compounds.

(b) Is acceptable to the United States Food and Drug Administration (FDA) Title 21 Section 175.300 of the Federal Regulation on Food Additives.

(c) Is acceptable for contact with potable water or is deemed non-toxic by a third party certification that is acceptable to the department.

(d) Is deemed non-toxic by the department.

(163e) "Nursing home" has the meaning specified under s. 50.01 (3), Stats.

Note: Section 50.01 (3), Stats., reads:

"Nursing home" means a place where 5 or more persons who are not related to the operator or administrator reside, receive care or treatment and, because of their mental or physical condition require access to 24-hour nursing services, including limited nursing care, intermediate level nursing care and skilled nursing services. "Nursing home" does not include any of the following:

(c) A convent or facility owned or operated exclusively by and for members of a religious order that provides reception and care or treatment of an individual.

(d) A hospice, as defined in s. 50.90 (1), Stats., that directly provides inpatient care.

(e) A residential care apartment/complex.

(163s) "Occasional occupancy" means occupying a building that is served by a POWTS for less than 120 calendar days per year.

(164) "Occupancy" means the purpose for which a building, structure, equipment, materials, or premises, or part thereof, is used or intended to be used.

(165) "Oil interceptor" means a device designed to intercept and retain oil, lubricating grease or other similar materials.

(166) "Offset" means a combination of fittings or bends which brings one section of the pipe out of line but into a line parallel with the other section.

(167) "One or 2-family dwelling" means a building containing not more than 2 dwelling units.

(168) "Open air" means outside the building.

(168m) "Open bodies of water" means those portions of Lake Michigan and Lake Superior within the boundaries of Wisconsin, all lakes, bays, rivers, streams, springs, ponds, wells, impounding reservoirs, marshes, watercourses, drainage systems and other surface water, natural or artificial, public or private within the state or under its jurisdiction.

(169) "Ordinary high-water mark" has the meaning specified under s. NR 115.03 (6).

Note: Section NR 115.03 (6) reads:

"Ordinary high-water mark" means the point on the bank or shore up to which the presence and action of surface water is so continuous as to leave a distinctive mark such as by erosion, destruction or prevention of terrestrial vegetation, predominance of aquatic vegetation, or other easily recognized characteristic. Where the bank or shore at any particular place is of such character that it is difficult or impossible to ascertain where the point of ordinary high-water mark is, recourse may be had to the opposite bank of a stream or to other places on the shore of a lake or flowage to determine whether a given stage of water is above or below the ordinary high-water mark.

(170) "Participating governmental unit" means a governmental unit which applies to the department for financial assistance under ss. Comm 87.04 and 87.05, and which meets the conditions specified under s. 145.245 (9), Stats.

(170e) "Patient area plumbing fixture" means a plumbing fixture that is accessible to patients in a health care facility and is intended to be used for culinary, hygienic or domestic purposes.

(171) "Peak flow" means the largest anticipated recurrent wastewater discharge to a private onsite wastewater treatment system.

(171e) "Peak flow, stormwater" means the largest anticipated flow from a given storm event.

(172) "Pipe applied atmospheric type vacuum breaker" means a type of cross connection control device where the flow of water into the device causes a float to close an air inlet port and when the flow of water stops the float falls and forms a check valve

against back siphonage and at the same time opens the air inlet port to allow air to enter and satisfy the vacuum.

(173) "Pit privy" means an enclosed nonportable toilet into which nonwater-carried human wastes are deposited to a subsurface storage chamber that is not watertight.

(174) "Pitch" means the gradient or slope of a line of pipe in reference to a horizontal plane.

(175) "Place of employment" has the meaning specified under s. 101.01 (11), Stats.

Note: Section 101.01 (11), Stats., reads:

"Place of employment" includes every place, whether indoors or out or underground and the premises appurtenant thereto where either temporarily or permanently any industry, trade or business is carried on, or where any process or operation, directly or indirectly related to any industry, trade or business, is carried on, and where any person is, directly or indirectly, employed by another for direct or indirect gain or profit, but does not include any place where persons are employed in private domestic service which does not involve the use of mechanical power or in farming. "Farming" includes those activities specified in s. 102.04 (3), and also includes the transportation of farm products, supplies or equipment directly to the farm by the operator of said farm or employees for the use thereon, if such activities are directly or indirectly for the purpose of producing commodities for market, or as an accessory to such production. When used with relation to building codes, "place of employment" does not include an adult family home, as defined in s. 50.01 (1), or, except for the purposes of s. 101.11, a previously constructed building used as a community-based residential facility, as defined in s. 50.01 (1g), which serves 20 or fewer unrelated residents.

(176) "Plumbing" has the meaning specified under s. 145.01 (10), Stats.

Note: Section 145.01 (10), Stats., reads:

"Plumbing" means and includes:

(a) All piping, fixtures, appliances, equipment, devices and appurtenances in connection with the water supply, water distribution and drainage systems, including hot water storage tanks, water softeners and water heaters connected with such water and drainage systems and also includes the installation thereof.

(b) The construction, connection or installation of any drain or waste piping system from the outside or proposed outside foundation walls of any building to the mains or other sewage system terminal within bounds of, or beneath an area subject to easement for highway purposes, including private sewage systems, and the alteration of any such systems, drains or waste piping.

(c) The water service piping from the outside or proposed outside foundation walls of any building to the main or other water utility service terminal within bounds of, or beneath an area subject to easement for highway purposes and its connections.

(d) The water pressure system other than municipal systems as provided in ch. 281.

(e) A plumbing and drainage system so designed and vent piping so installed as to keep the air within the system in free circulation and movement; to prevent with a margin of safety unequal air pressures of such force as might blow, siphon or affect trap seals, or retard the discharge from plumbing fixtures, or permit sewer air to escape into the building; to prohibit cross-connection, contamination or pollution of the potable water supply and distribution systems, and to provide an adequate supply of water to properly serve, cleanse and operate all fixtures, equipment, appurtenances and appliances served by the plumbing system.

(177) "Plumbing appliance" means any one of a special class of plumbing devices which is intended to perform a special function. The operation or control of the appliance may be dependent upon one or more energized components, such as motors, controls, heating elements, or pressure or temperature sensing elements. The devices may be manually adjusted or controlled by the user or operator, or may operate automatically through one or more of the following actions: a time cycle, a temperature range, a pressure range, or a measured volume or weight.

(178) "Plumbing fixture" means a receptacle or device which meets at least one of the following:

(a) Is either permanently or temporarily connected to the water supply system of the premises, and demands a supply of water from the system;

(b) Discharges wastewater or waste materials either directly or indirectly to the drain system of the premises.

(c) Requires both a water supply connection and a discharge to the drain system of the premises.

(179) "Plumbing system" includes the water supply system, the drain system, the vent system, plumbing fixtures, plumbing appliances and plumbing appurtenances that serve a building, structure or premises.

(180) "Point of standards application" has the meaning specified under s. 160.01 (5), Stats.

Note: Section 160.01 (5) Stats., reads:

"Point of standards application" means the specific location, depth or distance from a facility, activity or practice at which the concentration of a substance in groundwater is measured for purposes of determining whether a preventive action limit or an enforcement standard has been attained or exceeded.

(181) "Potable water" means water that is both:

(a) Safe for drinking, personal or culinary use.

(b) Free from impurities present in amounts sufficient to cause disease or harmful physiological effects.

(182) "POWTS" means a private onsite wastewater treatment system.

(183) "POWTS component" means any subsystem, subassembly or other system designed for use in or as part of a private onsite wastewater treatment system which may include treatment, dispersal or holding and related piping.

(184) "POWTS dispersal component" means a device or method that is intended to promote the assimilation of treated wastewater by the environment.

(185) "POWTS holding component" means any receptacle intended to collect wastewater for a period of time, including holding and dosing tanks.

(186) "POWTS treatment component" means a device or method that is intended to reduce the contaminant load of wastewater.

(186s) "Pre-development" means the condition of the topography of vegetation, including that resulting from human activities that existed prior to land disturbance for construction.

(187) "Prefabricated plumbing" means concealed drain piping, vent piping or water supply or a combination of these types of piping, contained in a modular building component, which will not be visible for inspection when delivered to the final site of installation.

(187e) "Prefabricated sump and pump system" means a simple or duplex pump and sump designed as a combined unit.

(188) "Pressure relief valve" means a pressure actuated valve held closed by a spring or other means and designed to automatically relieve pressure at a designated pressure.

(189) "Pressure vacuum breaker assembly" means a type of cross connection control assembly which consists of an independently operating internally loaded check valve and an independently operating loaded air inlet located on the discharge side of the check valve, a tightly closing shut-off valve located at each end of the assembly, and test cocks. The term "pressure vacuum breaker" has the same meaning as pressure vacuum breaker assembly.

(190) "Pressurized flushing device" means a device that uses the water supply to create a pressurized discharge to flush a fixture exclusive of gravity type flushing systems.

(191) "Preventive action limit" or "PAL" has the meaning as specified under s. 160.01 (6), Stats.

Note: Section 160.01 (6), Stats., reads:

"Prevention action limits" means a numerical value expressing the concentration of a substance in groundwater which is adopted under s. 160.15, Stats., and specified under s. NR 140.10 or 140.12.

(192) "Principal residence" means a residence that is occupied at least 51% of the year by the owner. Principal residence includes a residence owned by a trust or estate of an individual, if the residence is occupied at least 51% of the year by a person who has an ownership interest in the residence as a beneficiary of the trust or estate.

(193) "Private interceptor main sewer" means a sewer serving 2 or more buildings and not part of the municipal sewer system.

(194) "Private onsite wastewater treatment system" has the meaning given for 'private sewage system' under s. 145.01 (12), Stats.

Note: Section 145.01 (12), Stats., reads:

"Private sewage system" means a sewage treatment and disposal system serving a single structure with a septic tank and soil absorption field located on the same parcel as the structure. This term also means an alternative sewage system approved by the department including a substitute for the septic tank or soil absorption field, a

holding tank, a system serving more than one structure or a system located on a different parcel than the structure. A private sewage system may be owned by the property owner or by a special purpose district.

(195) "Private water main" means a water main serving 2 or more buildings and not part of the municipal water system.

(196) "Public" means, in the classification of plumbing fixtures, those fixtures which are available for use by the public or employees.

(197) "Public building" has the meaning specified under s. 101.01 (12), Stats.

Note: Section 101.01 (12), Stats., reads:

"Public building" means any structure, including exterior parts of such building, such as a porch, exterior platform or steps providing means of ingress or egress, used in whole or in part as a place of resort, assemblage, lodging, trade, traffic, occupancy, or use by the public or by 3 or more tenants. When used in relation to building codes, "public building" does not include a previously constructed building used as a community-based residential facility as defined in s. 50.01 (1g) which serves 20 or fewer unrelated residents or an adult family home, as defined in s. 50.01 (1).

(198) "Public sewer" means a sewer owned and controlled by a public authority.

(199) "Public water main" means a water supply pipe for public use owned and controlled by a public authority.

(200) "Quick closing valve" means a valve or faucet that closes automatically when released manually or controlled by mechanical means for fast action closing.

(201) "Receptor" means a fixture or device that receives the discharge from indirect or local waste piping.

(202) "Redoximorphic feature" means a feature formed in the soil matrix by the processes of reduction, translocation and oxidation of iron and manganese compounds in seasonally saturated soil.

(203) "Reduced pressure detector fire protection backflow prevention assembly" means a type of reduced pressure principle type backflow preventer serving a fire protection system and which includes a parallel flow meter to indicate leakage or unauthorized use of water downstream of the assembly.

(203m) "Reduced pressure fire protection principle backflow preventer" means an assembly serving a fire protection system and consisting of 2 independently-acting check valves, internally force loaded to a normally closed position, and separated by an intermediate chamber or zone in which there is a hydraulically operated relief means of venting to atmosphere, internally forced loaded to a normally open position. The term "reduced pressure principle backflow preventer for fire protection systems" has the same meaning as reduced pressure fire protection principle backflow preventer.

(204) "Reduced pressure principle backflow preventer" means a type of cross connection control assembly which contains 2 independently acting check valves, separated by an intermediate chamber or zone in which there is a hydraulically operated means for venting to atmosphere, and includes 2 shut-off valves and 4 test cocks.

(205) "Relief vent" means a vent which permits additional circulation of air in or between drain and vent systems.

(206) "Riser" means a water supply pipe that extends vertically one full story or more.

(207) "Roof drain" means a drain installed to receive water collecting on the surface of a roof and to discharge it into a conductor.

(208) "Roughing in" means the installation of all parts of the plumbing system which can be completed prior to the installation of fixtures including drain, water supply and vent piping and the necessary fixture supports.

(209) "Rowhouse" means a building which is not more than 3 stories in height and which contains only 3 or more attached, vertically separated, side-by-side or back-to-back dwelling units, with each dwelling unit served by an individual exterior exit within 6 feet of the exit discharge grade.

(210) "Safing" means a membrane or material installed beneath a fixture to prevent leakage from escaping to the floor, ceiling or walls.

(211) "Sand interceptor" means a receptacle designed to intercept and retain sand, grit, earth and other similar solids.

(212) "Sanitary sewer" means a pipe that carries wastewater consisting in part of domestic wastewater.

(212e) "Scrub sink" means a plumbing fixture used for hand and arm washing prior to surgery or other medical procedures.

Note: A scrub sink may also be referred to as a surgeon washup sink.

(213) "Scum" means the accumulated floating solids generated during the biological, physical or chemical treatment, coagulation or sedimentation of wastewater.

(214) "Secretary" means the secretary of the department of commerce or designee.

(214m) "Service sink" means a fixture designed to be used for building or facility maintenance.

Note: A service sink may also be referred to as a mop sink, mop basin or janitor's sink.

(215) "Servicing" has the meaning as specified under s. NR 113.03 (57).

Note: Under s. NR 113.03 (57) "servicing" means removing the scum, liquid, sludge or other wastes from a private sewage system such as septic or holding tanks, dosing chambers, grease interceptors, seepage beds, seepage pits, seepage trenches, privies or portable restrooms and properly disposing or recycling of the contents as provided in this chapter.

(216) "Sewage" means wastewater containing fecal coliform bacteria exceeding 200 CFU, colony forming units, per 100 ml.

(217) "Sewage grinder pump" means a type of sewage pump which macerates wastewater consisting in part of sewage.

(218) "Sewage pump" means an automatic pump for the removal of wastewater from a sanitary sump.

(219) "Slip-joint" means a connection in which one pipe slips into another, the joint of which is made tight with a compression type fitting.

(220) "Sludge" means the accumulated solids generated during the biological, physical or chemical treatment, coagulation or sedimentation of water or wastewater.

(221) "Small commercial establishment" means a commercial establishment or business place with a maximum daily wastewater flow rate of less than 5,000 gallons per day as determined from the design criteria of the state plumbing code. Small commercial establishment includes a farm, including a residence on a farm, if the residence is occupied by a person who is an operator of the farm and if the maximum daily wastewater flow rate of the farm and the residence on the farm is less than 5,000 gallons-per-day as determined from the design criteria of the state plumbing code.

(222) "Soil" means the naturally occurring pedogenically developed and undeveloped regolith overlying bedrock.

(223) "Soil consistence" means the resistance of soil material to deformation or rupture as related to the degree of adhesion and cohesion of a soil mass.

(224) "Soil horizon" means a layer of soil material approximately parallel to the land surface and differing from adjacent genetically related layers in physical, chemical, or biologic characteristics.

(225) "Soil morphology" means the physical or structural characteristics of a soil profile particularly as related to the arrangement of soil horizons based on color, texture, structure, consistence, and porosity.

(226) "Soil profile" means a vertical section of soil containing one or more soil horizons.

(227) "Soil profile evaluation" means a determination of soil properties or characteristics as they relate to wastewater or non-water-carried human waste treatment or dispersal.

(228) "Soil structure" means the combination or arrangement of individual soil particles into definable aggregates or peds, which are characterized and classified on the basis of size, shape, and degree of distinctness.

(229) "Soil texture" means the relative proportions of sand, silt and clay (soil separates) in a soil.

(230) "Spigot" means the end of a pipe which fits into a bell or hub.

(231) "Spill level" means the horizontal plane to which water will rise to overflow through channels or connections which are not directly connected to any drainage system, when water is flowing into a fixture, vessel or receptacle at the maximum rate of flow.

(231m) "Spill resistant vacuum breaker" means a cross connection control device consisting of one check valve force loaded closed, an air inlet force loaded open to atmosphere downstream of the check valve, 2 shutoff valves and 2 test cocks.

(232) "Spring line, pipe" means the line or place from which the arch of a pipe or conduit rises.

Note: See ch. Comm 82 Appendix for an illustration depicting the spring line of a pipe.

(233) "Stack" means a drain or vent pipe that extends vertically one full story or more.

(234) "Stack vent" means a vent extending from the highest horizontal drain connected to a stack.

(235) "Standpipe" means a drain pipe serving as a receptor for the discharge wastes from indirect or local waste piping.

(236) "State" means the state of Wisconsin, its agencies and institutions.

(237) "State plumbing code" means chs. Comm 81 to 87.

(238) "Sterilizer, boiling type" means a device of nonpressure type, used for boiling instruments, utensils, or other equipment for disinfecting.

(239) "Sterilizer, instrument" means a device for the sterilization of various instruments.

(240) "Sterilizer, pressure" means a pressure vessel fixture designed to use steam under pressure for sterilizing.

Note: A pressure sterilizer is also referred to as an autoclave.

(241) "Sterilizer, pressure instrument washer" means a pressure vessel designed to both wash and sterilize instruments during the operating cycle of the device.

(242) "Sterilizer, utensil" means a device for the sterilization of utensils.

(243) "Sterilizer vent" means a separate pipe or stack, indirectly connected to the drain system at the lower terminal, which receives the vapors from nonpressure sterilizers, or the exhaust vapors from pressure sterilizers, and conducts the vapors directly to the outer air.

(244) "Sterilizer, water" means a device for sterilizing water and storing sterile water.

(245) "Storm sewer" means a pipe, other than a pipe located inside a building, that carries any of the following: storm water, groundwater or clear water.

(246) "Storm water" means wastewater from a precipitation event.

(247) "Subsoil drain" means that part of a drain system that conveys groundwater to a point of discharge or dispersal.

(248) "Sump" means a tank or pit that receives wastewater that must be emptied by mechanical means.

(249) "Sump pump" means an automatic device located in a sump, pit or low point that is designed to elevate storm water, groundwater or clear water.

(250) "Sump vent" means a vent pipe from a nonpressurized sump.

(251) "Supports" means hangers, anchors and other devices for supporting and securing pipes or fixtures to structural members of a building.

(252) "Surface water" means those portions of Lake Michigan and Lake Superior within the boundaries of Wisconsin, all lakes, bays, rivers, streams, springs, ponds, impounding reservoirs, marshes, water courses, drainage systems, and other surface water, natural or artificial, public or private within the state or under its jurisdiction, except those waters which are entirely confined and completely retained upon the property of a facility.

(253) "Swimming pool" means a structure, basin, chamber or tank containing an artificial body of water for swimming, diving or recreational bathing.

(254) "Temperature and pressure relief valve" means a combination relief valve designed to function as both a temperature relief and pressure relief valve.

(255) "Temperature relief valve" means a temperature actuated valve designed to automatically discharge at a designated temperature.

(256) "Tempered water" means water ranging in temperature from 85°F. to less than 110°F.

(256e) "Ten-year, 24-hour storm" or "10-year, 24-hour storm" means a discrete rain storm event characterized by a specific duration, temporal distribution, rainfall intensity, return frequency and total depth of rainfall.

Note: The frequency, intensity and duration of rainfall varies considerably during a storm by geographic location. Precipitation frequency atlases, NOAA Atlas 2, have been prepared by the National Oceanic and Atmospheric Administration (NOAA), National Weather Service. In chapter Comm 82, this value may be expressed as a specific "design storm". The calculated volume of rainfall, or stormwater, may be determined from this value and used to calculate peak discharge.

(257) "Total suspended solids" or "TSS" means solids in wastewater that can be removed readily by standard filtering procedures in a laboratory and reported as milligrams per liter (mg/L).

(259) "Trap" means a fitting, device or arrangement of piping so designed and constructed as to provide, when properly vented, a liquid seal which prevents emission of sewer gases without materially affecting the flow of wastewater through it.

(260) "Trap seal" means the vertical distance between the top of the trap weir and the top of the dip separating the inlet and outlet of the trap.

(261) "Trap seal primer, water supply fed" means a type of valve designed to supply water to the trap in order to provide and maintain the water seal of the trap.

(262) "Trap weir" means that part of a trap that forms a dam over which wastes must flow to enter the drain piping.

(263) "Turf sprinkler system" means a system of piping, appurtenances and devices installed underground to distribute water for lawn or other similar irrigation purposes.

(264) "Unsaturated soil" means soil in which the pore spaces contain water at less than atmospheric pressure, as well as air and other gases.

(265) "Vacuum" means any pressure less than that exerted by the atmosphere.

(265e) "Vacuum breaker tee" means an assembly of fittings designed to eliminate the possibility of back siphonage in a system by allowing air to enter through a tee fitting.

(266) "Vacuum relief valve" means a device that admits air into the water distribution system to prevent excessive vacuum in a water storage tank or heater.

(267) "Vent" means a part of the plumbing system used to equalize pressures and ventilate the system.

(268) "Vent header" means a branch vent which connects 2 or more stack vents or vent stacks or both and extends to the outside air.

(269) "Vent stack" means a vertical vent pipe that provides air for a drain stack of 5 or more branch intervals.

(270) "Vent system" means a pipe or pipes installed to provide a flow of air to or from a drain system, or to provide a circulation of air within the system to protect trap seals from siphonage and back pressure.

(271) "Vertical pipe" means any pipe or fitting which makes an angle of 45° or less with the vertical.

(272) "Wall hydrant, freeze resistant automatic draining type vacuum breaker" means a type of device which is designed and constructed with anti-siphon and back pressure preventive capabilities and with means for automatic post shut-off draining to prevent freezing.

(273) "Wall mounted water closet" means a water closet attached to a wall in such a way that it does not touch the floor.

(273e) "Washer sanitizer" means a plumbing appliance used for washing and disinfecting equipment.

(274) "Waste" means the discharge from any fixture, appliance, area or appurtenance.

(275) "Waste sink" means a receptor for the discharge from indirect or local waste piping installed with its flood level rim above the surrounding floor.

(276) "Wastewater" means clear water, storm water, domestic wastewater, industrial wastewater, sewage or any combination of these.

(277) "Wastewater, treated" means the effluent conveyed through one or more POWTS treatment components to a POWTS dispersal component.

(277e) "Wastewater treatment device" means a device or method that is intended to beneficially alter the characteristics of wastewater.

(278) "Water closet" means a water-flushed plumbing fixture designed to receive human excrement directly from the user of the fixture.

(279) "Water conditioner" means an appliance, appurtenance or device used for the purpose of ion exchange, demineralizing water or other methods of water treatment.

(280) "Water distribution system" means that portion of a water supply system from the building control valve to the connection of a fixture supply connector, plumbing fixture, plumbing appliance, water-using equipment or other piping systems to be served.

(281) "Water heater" means any heating device with piping connections to the water supply system that is intended to supply hot water for domestic or commercial purposes other than space heating.

(282) "Water service" means that portion of a water supply system from the water main or private water supply to the building control valve.

(283) "Waters of the state" has the meaning specified under s. 281.01 (18), Stats.

Note: Section 281.01 (18), Stats., reads:
"Waters of the state" means those portions of Lake Michigan and Lake Superior within the boundaries of Wisconsin, all lakes, bays, rivers, streams, springs, ponds, wells, impounding reservoirs, marshes, watercourses, drainage systems and other surface water or groundwater, natural or artificial, public or private within the state or under its jurisdiction.

(284) "Water supply system" means the piping of a private water main, water service and water distribution system, fixture supply connectors, fittings, valves, and appurtenances through which water is conveyed to points of usage such as plumbing fixtures, plumbing appliances, water using equipment or other piping systems to be served.

(285) "Water treatment device" means a device which:

(a) Renders inactive or removes microbiological, particulate, inorganic, organic or radioactive contaminants from water which

passes through the device or the water supply system downstream of the device; or

(b) Injects into the water supply system gaseous, liquid or solid additives other than water, to render inactive microbiological, particulate, inorganic, organic or radioactive contaminants.

(286) "Wetland" has the meaning given in s. 23.32 (1), Stats.

(287) "Wetland, constructed" means a man-made design complex of saturated substrates, emergent and submergent vegetation, and water that simulate natural wetlands for human use and benefits.

(288) "Wet vent" means that portion of a vent pipe that receives the discharge from other fixtures.

(288e) "Whirlpool" has the meaning as specified under s. Comm 90.03 (23) (j).

Note: Section Comm 90.03 (23) (j) reads: "Whirlpool" means a relatively small public swimming pool that uses high temperature water (greater than 93°F) and that may include a water agitation system. A whirlpool may also be referred to as a spa.
Note: A fill and dump bathtub is not a whirlpool.

(288m) "Whirlpool bath tub" means a plumbing appliance consisting of a bathtub fixture that is equipped and fitted with a circulation piping system designed to accept, circulate and discharge bathtub water upon each use.

(289) "Yoke vent" means a vent connected to a drain stack for the purpose of preventing pressure changes in the drain stack.

History: Cr. Register, April, 2000, No. 532, eff. 7-1-00; cr. (7e), (17e), (60e), (67e), (67m), (82m), (90e), (163e), (170e), (199e), (209e), (209m), (252e), (288e) and (288m), am. (18), (20), (79), (80), (189), (203) and (204), r. and recr. (116), Register, December, 2000, No. 540, eff. 1-1-01; CR 01-139: am. (209) Register June 2002 No. 558, eff. 7-1-02; corrections in (152) and (154) made under s. 13.93 (2m) (b) 7, Stats., Register June 2002 No. 558; CR 02-002: am. (7e), (42), (44), (46), (56), (80), (84), (90e), (120), (134), (147), (178), (181), (193), (195), (210), (245), (246), (247), and (276), cr. (7m), (35m), (51m), (56e), (61m), (62m), (65m), (72e), (90m), (108m), (160m), (187e), (212e), (214m), (265e), (273e), and (277e), r. and recr. (249) Register April 2003 No. 568, eff. 5-1-03; CR 02-129: cr. (2m) and (168m) Register January 2004 No. 577, eff. 2-1-04; CR 04-035: cr. (59m), (59s), (62s), (70m), (129s), (133s), (136s), (171e), (186s) and (256e), am. (234) and (269) Register November 2004 No. 587, eff. 12-1-04; CR 07-100: cr. (163s) Register September 2008 No. 633, eff. 10-1-08; correction in (288e) made under s. 13.92 (4) (b) 7, Stats., Register September 2008 No. 633; CR 08-055: am. (5), (79), (115), (120), (147), (156), (189), (204), (234), (269) and (288), r. (20), (67e), (67m), (199e), (209e), (209m), (252e) and (258), cr. (80m), (82e), (108s), (203m) and (231m), r. and recr. (80), (151) to (154), (163) and (203) Register February 2009 No. 638, eff. 3-1-09; corrections in (286) and (288e) made under s. 13.92 (4) (b) 7, Stats., and corrections to numbering of (80m), (108s) and (203m) made under s. 13.92 (4) (b) 1., Stats., Register February 2009 No. 638.

Comm 81.20 Incorporation of standards by reference. (1) CONSENT. (a) Pursuant to s. 227.21 (2), Stats., the attorney general has consented to the incorporation by reference of the standards listed in sub. (3).

(b) The codes and standards that are referenced in this chapter, and any additional codes and standards that are subsequently referenced in those codes and standards, shall apply to the prescribed extent of each such reference, except as modified by this chapter.

Note: Copies of the adopted standards are on file in the offices of the department and the legislative reference bureau. Copies of the standards may be purchased through the respective organizations listed in Tables 81.20-1 to 81.20-13.

(2) ALTERNATE STANDARDS. (a) Alternate standards that are equivalent to or more stringent than the standards referenced in this code may [be] used in lieu of the referenced standards when approved by the department or if written approval is issued by the department in accordance with par. (b).

1. Upon receipt of a fee and a written request, the department may issue an approval for the use of the alternate standard.

2. The department shall review and make a determination on an application for approval within 40 business days of receipt of all forms, fees and documents required to complete the review.

Note: Review fees for standards under this paragraph are listed in ch. Comm 2.

(b) Determination of approval shall be based on an analysis of the alternate standard and the standard referenced in this code, prepared by a qualified independent third party or the organization that published the standard contained in this code.

(c) The department may include specific conditions in issuing an approval, including an expiration date for the approval. Viola-

tions of the conditions under which an approval is issued shall constitute a violation of this code.

(d) If the department determines that the alternate standard is not equivalent to or more stringent than the referenced standard, the request for approval shall be denied in writing.

(e) The department may revoke an approval for any false statements or misrepresentations of facts on which the approval was based.

(f) The department may reexamine an approved alternate standard and issue a revised approval at any time.

(3) **ADOPTION OF STANDARDS.** The standards referenced in Tables 81.20-1 to 81.20-13 are hereby incorporated by reference into this chapter.

Note: The tables in this section provide a comprehensive listing of all of the standards adopted by reference in this code. For requirements or limitations in how these standards are to be applied, refer to the code section that requires compliance with the standard.

(4) **DEPARTMENT AUTHORITY.** A department interpretation of an adopted standard under this chapter shall supersede any differing interpretation by either a lower level jurisdiction or an issuer of the adopted standard.

Table 81.20-1

Table 81.20-1	
Standard Reference Number	Title
AHAM	Association of Home Appliance Manufacturers 20 North Wacker Drive Chicago, Illinois 60606 Phone: 202-872-5955 Web page: www.aham.org
DW-1-2005	Household Electric Dishwashers

Table 81.20-2

Table 81.20-2	
Standard Reference Number	Title
ANSI	American National Standards Institute, Inc. 1430 Broadway New York, New York 10018 Phone: 212-642-4900 Web page: www.ansi.org
1.	Z21.22-99 (R 2004) Relief Valves for Hot Water Supply Systems
2.	Z21.22a-2000 Relief Valves for Hot Water Supply Systems (Addenda 2000)
3.	Z21.22b-2001 Relief Valves for Hot Water Supply Systems (Addenda 2001)
4.	Z124.1.2-2005 Plastic Shower Receptors and Shower Stalls
5.	Z124.3-2005 Plastic Lavatories
6.	Z124.4-2006 Plastic Water Closet Bowls and Tanks
7.	Z124.6-97 Plastic Sinks
8.	Z124.9-2004 Plastic Urinal Fixtures

Table 81.20-3

Table 81.20-3	
Standard Reference Number	Title
ARI	Air-Conditioning and Refrigeration Institute 1815 North Fort Myer Drive Arlington, Virginia 22209 Phone: 703-524-8800 Web page: www.ari.org
ARI-1010-2002	Self-Contained Mechanically-Refrigerated Drinking-Water Coolers

Table 81.20-3e

ASME		American Society of Mechanical Engineers 345 East 47th Street New York, New York 10017 Phone: 800-843-2763 Web page: www.infocentral@asme.org
Standard Reference Number	Title	
1.	A112.1.2-2004	Air Gaps in Plumbing Systems (For Plumbing Fixtures and Water-Connected Receptors)
1e.	A112.1.3-00	Air-gap Fittings for Use with Plumbing Fixtures, Appliances, and Appurtenances
2.	A112.6.1M-97 (R 2002)	Floor-Affixed Supports for Off-the-Floor Plumbing Fixtures for Public Use
2m.	A112.6.3-2001	Floor and Trench Drains
3.	A112.14.1-03 (R 2008)	Backwater Valves
4.	A112.18.1-2005	Plumbing Supply Fittings
5.	A112.19.1M-94 (R 2004)	Enameled Cast Iron Plumbing Fixtures
5m.	A112.19.1M-1994	Errata November 1994 to Enameled Cast Iron Plumbing Fixtures
6.	A112.19.1M-1994	Supplement 1-1998 to Enameled Cast Iron Plumbing Fixtures
7.	A112.19.1M-1994	Supplement 2-2000 to Enameled Cast Iron Plumbing Fixtures
8.	A112.19.2-2003	Vitreous China Plumbing Fixtures and Hydraulic Requirements for Water Closets and Urinals
9.	A112.19.3-2000 (R 2004)	Stainless Steel Plumbing Fixtures (Designed for Residential Use)
10.	A112.19.3-2002	Supplement 1-2002 to Stainless Steel Plumbing Fixtures (Designed for Residential Use)
11.	A112.19.4-94 (R 2004)	Porcelain Enameled Formed Steel Plumbing Fixtures
12.	A112.19.5-2005	Trim for Water-Closet Bowls, Tanks, and Urinals
13.	B1.20.1-83 (R 2006)	Pipe Threads, General Purpose (Inch)
14.	B16.1-2005	Gray Iron Pipe Flanges and Flanged Fittings (Classes 25, 125, and 250)
15.	B16.3-1998 (R 2006)	Malleable Iron Threaded Fittings (Classes 150 and 300)
16.	B16.4-2006	Gray Iron Threaded Fittings (Classes 125 and 250)
17.	B16.5-2003	Pipe Flanges and Flanged Fittings NPS 1/2 Through NPS 24 (and addenda)
18.	B16.9-2003	Factory-Made Wrought Butt welding Fittings
19.	B16.11-2005	Forged Fittings, Socket-Welding and Threaded
20.	B16.12-1998 (R 2006)	Cast Iron Threaded Drainage Fittings
21.	B16.15-85 (R1994)	Cast Bronze Threaded Fittings, Classes 125 and 250
22.	B16.18-2001 (R 2005)	Cast Copper Alloy Solder Joint Pressure Fittings
23.	B16.22-2001 (R 2005)	Wrought Copper and Copper Alloy Solder Joint Pressure Fittings
24.	B16.23-2002 (R 2006)	Cast Copper Alloy Solder Joint Drainage Fittings : DWV
25.	B16.24-2001	Cast Copper Alloy Pipe Flanges and Flanged Fittings: Class 150, 300, 400, 600, 900, 1500 and 2500
26.	B16.26-2006	Cast Copper Alloy Fittings for Flared Copper Tubes
27.	B16.28-94	Wrought Steel Butt welding Short Radius Elbows and Returns
28.	B16.29-2001	Wrought Copper and Wrought Copper Alloy Solder Joint Drainage Fittings — DWV
29.	B16.42-1998 (R 2006)	Ductile Iron Pipe Flanges and Flanged Fittings (Classes 150 and 300)
30.	B16.45-1998 (R 2006)	Cast Iron Fittings for Sovent® Drainage Systems
31.	B36.19M-2004	Stainless Steel Pipe

Table 81.20-4

ASSE		American Society of Sanitary Engineering P.O. Box 9712 Bay Village, Ohio 4414 Phone: 440-835-3040 Web page: www.asse-plumbing.org
Standard Reference Number	Title	
1.	1001-2002	Atmospheric Type Vacuum Breakers
2.	1002-1999	Anti-siphon Fill Valves (Ballcocks) for Gravity Water Closet Flush Tanks
3.	1003-2001	Water Pressure Reducing Valves
4.	1004-1990	Commercial Dishwashing Machines
5.	1006-1989	Residential Use (Household) Dishwashers
6.	1007-1992	Home Laundry Equipment
7.	1008-2006	Plumbing Aspects of Residential Food Waste Disposer Units
8.	1009-1990	Commercial Food Waste Grinder Units
9.	1010-2004	Water Hammer Arresters
10.	1011-2004	Hose Connection Vacuum Breakers
11.	1012-2002	Backflow Preventer with Intermediate Atmospheric Vent
12.	1013-2005	Reduced Pressure Principle Backflow Preventers and Reduced Pressure Fire Protection Principle Backflow Preventers
13.	1014-2005	Backflow Prevention Devices for Hand-Held Showers
14.	1015-2005	Double Check Backflow Prevention Assemblies and Double Check Fire Protection Backflow Prevention Assemblies
15.	1016-2005	Automatic Compensating Valves for Individual Showers and Tub/Shower Combinations
15m.	1017-2003	Temperature Actuated Mixing Valves for Hot Water Distribution Systems
16.	1018-2001	Trap Seal Primer Valves — Potable Water Supplied
17.	1019-2004	Vacuum Breaker Wall Hydrants, Freeze Resistant Automatic Draining Type
18.	1020-2004	Pressure Vacuum Breaker Assembly
18m.	1021-2001	Drain Air Gaps for Domestic Dishwasher Applications
19.	1022-2003	Backflow Preventer for Beverage Dispensing Equipment
20.	1023-1979	Hot Water Dispensers, Household Storage Type, Electrical
20m.	1035-2002	Laboratory Faucet Backflow Preventers
21.	1037-1990	Pressurized Flushing Devices (Flushometers) for Plumbing Fixtures
22.	1047-2005	Reduced Pressure Detector Fire Protection Backflow Prevention Assemblies
23.	1048-2005	Double Check Detector Fire Protection Backflow Prevention Assemblies
24.	1052-2004	Hose Connection Backflow Preventers
24e.	1053-2005	Dual Check Backflow Preventer Wall Hydrant Freeze Resistant Type
25.	1055-1997	Chemical Dispensing Systems
26.	1056-2001	Spill Resistant Vacuum Breakers
26e.	1066-1997	Individual Pressure Balancing In-Line Valves for Individual Fixture Fittings
27.	5013-2004 ^a	Minimum Performance Requirements for Testing Reduced Pressure Principle Backflow Preventers (RP) and Reduced Pressure Principle Fire Protection Backflow Preventers (RPF)
28.	5015-2004 ^a	Minimum Performance Requirements for Testing Double Check Backflow Prevention Assemblies (DC) and Double Check Fire Protection Backflow Prevention Assemblies (DCF)
29.	5020-2004 ^a	Minimum Performance Requirements for Testing a Pressure Vacuum Breaker Assembly
30.	5047-2004 ^a	Minimum Performance Requirements for Testing Reduced Pressure Detector Fire Protection Backflow Prevention Assemblies (RPDF)
31.	5048-2004 ^a	Minimum Performance Requirements for Testing Double Check Detector Fire Protection Backflow Prevention Assemblies (DCDF)
32.	5056-2004 ^a	Minimum Performance Requirements for Testing Spill Resistant Vacuum Breaker

^a Standard is contained in the ASSE 5000 Series of standards.

Table 81.20-5

ASTM		ASTM International 100 Barr Harbor Drive West Conshohocken, Pennsylvania 19428-2959 Phone: (610) 832-9585 Web page: www.astm.org
Standard Reference Number	Title	
1.	A53-02	Pipe, Steel, Black and Hot-Dipped, Zinc-Coated Welded and Seamless, Specification for
2.	A74-06	Cast Iron Soil Pipe and Fittings, Specification for
3.	A123/A123M-02	Zinc (Hot-Galvanized) Coatings on Products, Specification for
4.	A270-03a	Seamless and Welded Austenitic Stainless Steel Sanitary Tubing, Specification for
5.	A403/A403M-07	Wrought Austenitic Stainless Steel Piping Fittings, Specification for
6.	A450/A450M-04a	Carbon, Ferritic Alloy, and Austenitic Alloy Steel Tubes
7.	A888-07a	Hubless Cast Iron Soil Pipe and Fittings for Sanitary and Storm Drain, Waste, and Vent Pipe Applications, Specifications for
8.	B32-04	Solder Metal
9.	B42-02 ^{E1}	Pipe, Seamless Copper, Standard Sizes
10.	B43-98	Seamless Red Brass Pipe, Standard Sizes, Specification for
11.	B88-03	Seamless Copper Water Tube, Specification for
11m.	B88M-05	Seamless Copper Water Tube, (Metric) Specification for
12.	B152/B152M-06a.	Copper Sheet, Strip, Plate, and Rolled Bar, Specification for
13.	B251/B251M-02 ^{E1}	Tube, Wrought Seamless Copper and Copper
14.	B302-02	Threadless Copper Pipe, Specification for
15.	B306-02	Copper Drainage Tube (DWV), Standard Specifications for
15m.	B828-02	Making Capillary Joints by Soldering of Copper and Copper Alloy Tube and Fittings, Practice for
16.	C14-07	Nonreinforced Concrete Sewer, Storm Drain, and Culvert Pipe, Specification for
17.	C14M-07	Nonreinforced Concrete Sewer, Storm Drain, and Culvert Pipe, (Metric) Specification for
18.	C33-03	Concrete Aggregates, Specification for
19.	C76-07	Reinforced Concrete Culvert, Storm Drain, and Sewer Pipe, Specification for
20.	C76M-07	Reinforced Concrete Culvert, Storm Drain, and Sewer Pipe, (Metric) Specifications for
21.	C425-04	Compression Joints for Vitrified Clay Pipe and Fittings, Specification for
22.	C443-07	Specification for Joints for Circular Concrete Sewer and Culvert Pipe, Using Rubber Gaskets
22e.	C443M-07	Specification for Joints for Circular Concrete Sewer and Culvert Pipe, Using Rubber Gaskets (Metric)
22m.	C507/C507M-07	Reinforced Concrete Elliptical Culvert, Storm Drain and Sewer, (Metric) Specifications for
23.	C564-03a	Rubber Gaskets for Cast Iron Soil Pipe and Fittings, Specification for
24.	C700-07	Vitrified Clay Pipe, Extra Strength, Standard Strength, and Perforated, Specification for
24e.	C877/C877M-02 ^E	External Sealing Bands for Concrete Pipe, Manholes and Precast Box Sections, (Metric) Standard Specifications for
24h.	C923-07	Resilient Connectors Between Reinforced Concrete Manhole Structures, Pipes, and Laterals, Specification for
24m.	C990/C990M-06	Joints for Concrete Pipe, Manholes, Precast Box Sections Using Preformed Flexible Joint Sealants, Specifications for
24s.	C1306-05a	Hydrostatic Pressure Resistance of a Liquid-Applied Waterproofing Membrane, Standard Test Method for
25.	D1527-99 (R 2005)	Acrylonitrile-Butadiene-Styrene (ABS), Schedules 40 and 80
26.	D1785-06	Poly (Vinyl Chloride) (PVC) Plastic Pipe, Schedules 40, 80 and 120, Specification for
27.	D2104-03	Standard Specifications for Polyethylene (PE) Plastic Pipe, Schedule 40

Table 81.20-5 (Continued)

ASTM		ASTM International 100 Barr Harbor Drive West Conshohocken, Pennsylvania 19428-2959 Phone: (610) 832-9585 Web page: www.astm.org
Standard Reference Number	Title	
28. D2235-04	Standard Specifications for Solvent Cement for Acrylonitrile-Butadiene-Styrene (ABS) Plastic Pipe and Fittings	
29. D2239-03	Polyethylene (PE) Plastic Pipe (SIDR-PR) Based on Controlled Inside Diameter, Specification for	
30. D2241-05	Standard Specification for Poly (Vinyl Chloride) (PVC) Plastic Pipe (SDR-Series)	
31. D2282-99 (R 2005)	Acrylonitrile-Butadiene-Styrene (ABS) Plastic Pipe (SDR-PR), Specification for	
32. D2321-05	Underground Installation of Thermoplastic Pipe for Sewers and Other Gravity-Flow Applications, Practice for	
33. D2447-03	Polyethylene (PE) Plastic Pipe, Schedules 40 and 80, Based on Outside Diameter, Specification for	
34. D2464-06	Threaded Poly (Vinyl Chloride) (PVC) Plastic Pipe Fittings, Schedule 80, Specification for	
35. D2466-06	Poly (Vinyl Chloride) (PVC) Plastic Pipe Fittings, Schedule 40, Specification for	
36. D2467-06	Poly (Vinyl Chloride) (PVC) Plastic Pipe Fittings, Schedule 80, Specification for	
37. D2468-96a	Acrylonitrile-Butadiene-Styrene (ABS), Plastic Pipe Fittings, Schedule 40, Specification for	
38. D2564-04 ^{E1}	Solvent Cements for Poly (Vinyl Chloride) (PVC) Plastic Systems, Specification for	
39. D2609-02	Plastic Insert Fittings for Polyethylene (PE) Plastic Pipe, Specification for	
40. D2657-07	Heat Fusion Joining of Polyolefin Pipe and Fittings, Standard Practice of	
41. D2661-06	Acrylonitrile-Butadiene-Styrene (ABS) Schedule 40 Plastic Drain, Waste, and Vent Pipe and Fittings, Specification for	
43. D2665-07	Poly (Vinyl Chloride) (PVC) Plastic Drain, Waste, and Vent Pipe and Fittings, Specification for	
46. D2680-01	Acrylonitrile-Butadiene-Styrene (ABS) and Poly (Vinyl Chloride) (PVC) Composite Sewer Piping, Specification for	
47. D2683-04	Socket-Type Polyethylene Fittings for Outside Diameter-Controlled Polyethylene Pipe and Tubing, Specification for	
48. D2729-03	Poly (Vinyl Chloride) (PVC) Sewer Pipe and Fittings, Specification for	
49. D2737-03	Polyethylene (PE) Plastic Tubing, Specification for	
50. D2751-05	Acrylonitrile-Butadiene-Styrene (ABS) Sewer Pipe and Fittings, Specification for	
51. D2774-04 ^{E1}	Underground Installation of Thermoplastic Pressure Piping, Standard Practice for	
52. D2846/D2846M-06	Chlorinated Poly (Vinyl Chloride) (CPVC) Plastic Hot- and Cold-Water Distribution Systems, Specification for	
53. D2852-95	Styrene-Rubber (SR) Plastic Drain Pipe and Fittings, Specification for	
54. D2855-96	Making Solvent-Cemented Joints with Poly (Vinyl Chloride) (PVC) Pipe and Fittings, Practice for	
55. D3034-06	Type PSM Poly (Vinyl Chloride) (PVC) Sewer Pipe and Fittings, Specification for	
56. D3035-06	Polyethylene (PE) Plastic Pipe (SDR-PR) Based on Controlled Outside Diameter, Specification for	
57. D3138-04	Solvent Cements for Transition Joints Between Acrylonitrile-Butadiene-Styrene (ABS) and Poly(Vinyl Chloride) (PVC) Non-Pressure Piping Components, Specifications for	
59. D3140-90	Flaring Polyolefin Pipe and Tubing, Practice for	
60. D3212-96a (R 2003)	Joints for Drain and Sewer Plastic Pipes Using Flexible Elastomeric Seals, Specification for	
61. D3261-03	Butt Heat Fusion Polyethylene (PE) Plastic Fittings for Polyethylene (PE) Plastic Pipe and Tubing, Specification for	
62. D3311-06a	Drain, Waste, and Vent (DWV) Plastic Fittings Patterns, Specification for	
63. D4068-01	Chlorinated Polyethylene (CPE) Sheeting for Concealed Water-Containment Membrane, Standard Test Method for	

Table 81.20-5 (Continued)

ASTM		ASTM International 100 Barr Harbor Drive West Conshohocken, Pennsylvania 19428-2959 Phone: (610) 832-9585 Web page: www.astm.org
Standard Reference Number	Title	
64.	D4491-99a (R 2004)	Water Permeability of Geotextile by Permittivity, Standard Test Method for
65.	D4533-04	Trapezoid Tearing Strength of Geotextiles, Standard Test Method for
66.	D4632-91 (R 2003)	Grab Breaking Load and Elongation of Geotextiles, Standard Test Method for
67.	D4751-04	Determining the Apparent Opening Size of a Geotextile, Standard Test Method for
68.	D4833-00 ^{E1}	Index Puncture Resistance of Geotextile, Geomembranes, and Related Products, Standard Test Methods for
69.	F402-05	Safe Handling of Solvent Cements, Primers and Cleaners Used for Joining Thermoplastic Pipe and Fittings, Practice for
70.	F405-05	Corrugated Polyethylene (PE) Tubing and Fittings, Specification for
71.	F409-02	Thermoplastic Accessible and Replaceable Plastic Tube and Tubular Fittings, Specification for
72.	F437-06	Threaded Chlorinated Poly (Vinyl Chloride) (CPVC) Plastic Pipe Fittings, Schedule 80, Specification for
73.	F438-04	Socket-Type Chlorinated Poly (Vinyl Chloride) (CPVC) Plastic Pipe Fittings, Schedule 40, Specification for
74.	F439-06	Socket-Type Chlorinated Poly (Vinyl Chloride) (CPVC) Plastic Pipe Fittings, Schedule 80, Specification for
75.	F441/F441M-02	Chlorinated Poly (Vinyl Chloride) (CPVC) Plastic Pipe, Schedules 40 and 80, Specification for
76.	F442/F442M-99 (R 2005)	Chlorinated Poly (Vinyl Chloride) (CPVC) Plastic Pipe (SDR-PR), Specification for
77.	F477-07	Elastomeric Seals (Gaskets) for Joining Plastic Pipe, Specification for
78.	F492-95	Propylene and Polypropylene (PP) Plastic-Lined Ferrous Metal Pipe Fittings
79.	F493-04	Solvent Cements for Chlorinated Poly (Vinyl Chloride) (CPVC) Plastic Pipe and Fittings, Specification for
80.	F628-06 ^{E1}	Acrylonitrile-Butadiene-Styrene (ABS) Schedule 40 Plastic Drain, Waste, and Vent Pipe with a Cellular Core, Specification for
81.	F656-02	Primers for Use in Solvent Cement Joints of Poly (Vinyl Chloride) (PVC) Plastic Pipe and Fittings, Specification for
81e.	F679-06a	Poly (Vinyl Chloride) (PVC) Large-Diameter Plastic Gravity Sewer Pipe and Fittings
81m.	F789-95a	Type PS-46 Poly (Vinyl Chloride) (PVC) Plastic Gravity Flow Sewer Pipe and Fittings
81s.	F794-03	Poly (Vinyl Chloride) (PVC) Profile Gravity Sewer Pipe and Fittings Based on Controlled Inside Diameter
82.	F810-07	Smoothwall Polyethylene (PE) Pipe for Use in Drainage and Waste Disposal Absorption Fields, Specification for
84.	F876-06	Crosslinked Polyethylene (PEX) Tubing, Specification for
85.	F877-07	Crosslinked Polyethylene (PEX) Plastic Hot- and Cold-Water Distribution Systems, Specification for
86.	F891-04	Coextruded Poly (Vinyl Chloride) (PVC) Plastic Pipe With a Cellular Core, Specification for
87.	F949-06a	Poly (Vinyl Chloride) (PVC) Corrugated Sewer Pipe With a Smooth Interior and Fittings
88.	F1281-07	Crosslinked Polyethylene/Aluminum/Crosslinked Polyethylene (PEX-AL-PEX) Pressure Pipe
89.	F1282-06	Polyethylene/Aluminum/Polyethylene (PE-AL-PE) Composite Pressure Pipe
90.	F1336-07	Poly (Vinyl Chloride) (PVC) Gasketed Sewer Fittings
91.	F1807-07	Metal Insert Fittings Utilizing a Copper Crimp Ring for SDR9 Cross-linked Polyethylene (PEX) Tubing
92.	F1866-07	Poly (Vinyl Chloride) (PVC) Plastic Schedule 40 Drainage and DWV Fabricated Fittings, Specifications for

Table 81.20-6

American Welding Society 550 N.W. LeJune Road Miami, Florida 33126 Phone: 800-443-9353 Web page: www.aws.org/w/a	
Standard Reference Number	Title
AWS.A5.8M 2004	Filler Metals for Brazing and Braze Welding, Specification for

Table 81.20-7

American Water Works Association Data Processing Department 6666 West Quincy Avenue Denver, Colorado 80235 Phone: 303-794-7711 Web page: www.awwa.org	
Standard Reference Number	Title
1. C110-03	American National Standard for Ductile-Iron and Gray-Iron Fittings for Water
2. C111-07	American National Standard for Rubber-Gasket Joints for Ductile-Iron Pressure Pipe and Fittings
3. C115-05	American National Standard for Flanged Ductile-Iron Pipe with Ductile-Type Iron or Gray-Iron Pipe Threaded Flanges
4. C151-02	Ductile-Iron Pipe, Centrifugally Cast, for Water
5. C153-06	American National Standard for Ductile-Iron Compact Fittings, 3 in. through 16 in., for Water and Other Liquids
5e. C651-05	Water Mains, Disinfecting
6. C700-02	Cold-Water Meters — Displacement Type with Bronze Main Case (w/ 1991 Addendum)
7. C701-07	Cold-Water Meters — Turbine Type for Customer Service
8. C702-01	Cold-Water Meters — Compound Type
9. C704-02	Cold-Water Meters — Propeller Type for Main Line Applications
10. C706-96 (R 05)	Cold-Water Meters, Direct-Reading, Remote-Registration Systems for
11. C707-05	Cold-Water Meters, Encoder-Type, Remote-Registration Systems for
12. C708-05	Cold-Water Meters — Multi-Jet Type
13. C710-02	Cold-Water Meters, Displacement Type — Plastic Main
14. C900-07	Polyvinyl Chloride (PVC) Pressure Pipe and Fabricated Fittings 4-inch to 12-inch (100mm Through 300mm) for Water Transmission and Distribution
15. C901-02	Polyethylene (PE) Pressure Pipe and Tubing, 1/2 in. (13mm) Through 3 in. (76mm) for Water Service
16. C906-07	Polyethylene Pressure Pipe and Fittings, 4 in. through 63 in., for Water Distribution

Table 81.20-7e

Canadian Standards Association		
178 Rexdale Boulevard		
Rexdale (Toronto), Ontario, Canada		
M9W 1R3		
Phone: 800-463-6727		
Web page: www.csa.ca		
Standard Reference Number	Title	
1.	B64.1.1-07	Atmospheric Vacuum Breakers
2.	B64.1.2-07	Pressure Vacuum Breakers
3.	B64.1.3-07	Spill Resistant Vacuum Breakers
4.	B64.2-07	Hose Connection Vacuum Breakers
5.	B64.2.2-07	Hose Connection Vacuum Breakers with Automatic Draining Feature
6.	B64.3-07	Dual Check Valve Backflow Preventers with Atmospheric Port
7.	B64.3.1-07	Dual Check Valve Backflow Preventers with Atmospheric Port for Carbonators
8.	B64.4-07	Reduced Pressure Principle Backflow Preventers
9.	B64.4.1-07	Reduced Pressure Principle Backflow Preventers for Fire Protection Systems
10.	B64.5-07	Double Check Valve Backflow Preventers
11.	B64.5.1-07	Double Check Valve Backflow Preventers for Fire Protection Systems
12.	B64.7-07	Laboratory Faucet Vacuum Breakers
13.	CSA B125.1-05	Plumbing Supply Fittings
14.	B125.3-05	Plumbing Fittings
14e.	B125.3-05	Plumbing Fittings – Update No. 1 November 2006
14m.	B125.3-05	Plumbing Fittings – Update No. 2 November 2007
15.	B137.9-98	Polyethylene / Aluminum / Polyethylene Composite Pressure Pipe Systems
16.	B137.10-98	Crosslinked Polyethylene / Aluminum / Crosslinked Polyethylene Composite Pressure Pipe Systems
17.	B181.1-06	Acrylonitrile-butadiene-styrene (ABS) drain, waste, and vent pipe and pipe fittings
18.	B181.2-06	Polyvinylchloride (PVC) and chlorinated polyvinylchloride (CPVC) drain, waste, and vent pipe and pipe fittings

Table 81.20-8

Cast Iron Soil Pipe Institute		
5959 Shallowford Road, Suite 419		
Chattanooga, Tennessee 37421		
Phone: 423-892-0137		
Web page: www.cispi.org		
Standard Reference Number	Title	
1.	301-05	Hubless Cast Iron Soil Pipe and Fittings for Sanitary and Storm Drain, Waste, and Vent Piping Applications, Standard Specification for
2.	310-04	Coupling for Use in Connection with Hubless Cast Iron Soil Pipe and Fittings for Sanitary and Storm Drain, Waste, and Vent Piping Applications, Specification for

Table 81.20-9

Factory Mutual Research Corp.		
1151 Boston-Providence Turnpike		
Norwood, Massachusetts 02062		
Phone: 800-320-6808		
Web page: www.fmglobal.com		
Standard Reference Number	Title	
1680	Couplings used in Hubless Cast Iron Systems for Drain, Waste or Vent, Sewer, Rainwater or Storm Drain Systems Above and Below Ground, Industrial/Commercial and Residential, January 1989	

Table 81.20-10

National Fire Protection Association 11 Tracy Drive Avon, MA 02322-9908 Phone: 617-770-3000 Web page: www.nfpa.org		
Standard Reference Number	Title	
1. NFPA 13D-2007	Installation of Sprinkler Systems in One- and Two-Family Dwellings and Manufactured Homes, Standard for the	
2. NFPA 24-2007	Installation of Private Fire Service Mains and Their Appurtenances, Standard for the	

Table 81.20-11

NSF International 789 Dixboro Road P.O. Box 130140 Ann Arbor, Michigan 48113-0140 Phone: (800) 673-6275 Web page: www.nsf.org		
Standard Reference Number	Title	
1. Standard 14-2007	Plastic Piping System Components and Related Materials	
2. Standard 40-2005	Residential Wastewater Treatment Systems	
3. Standard 41-2005	Non-liquid Saturated Treatment Systems	
3m. Standard 41-2005 Addendum 1	Non-liquid Saturated Treatment Systems	
4. Standard 44-2004	Residential Cation Exchange Water Softeners	
5. Standard 51-2007	Food Equipment Materials	
6. Standard 61-2007	Drinking Water System Components Health Effects	

Table 81.20-12

Steel Tank Institute 570 Oakwood Road Lake Zurich, Illinois 60047 Phone: 617-770-3000 Web page: www.steeltank.com		
Standard Reference Number	Title	
STI-P ₃	External Corrosion Protection of Underground Steel Storage Tanks, Specifications and Manual for, 1996 edition	

Table 81.20-13

Underwriters Laboratories Inc. 333 Pfingsten Road Northbrook, Illinois 60062 Phone: 847-272-8800 Web page: www.ul.com		
Standard Reference Number	Title	
1. Standard 58-1996	Steel Underground Tanks for Flammable and Combustible Liquids — Ninth Edition	
2. Standard 1746-2007	External Corrosion Protection Systems for Steel Underground Storage Tanks — Third Edition	

History: Cr. Register, April, 2000, No. 532, eff. 7-1-00; r. (2), renun. (3) to be (2) and am., r. and recr. Table 81.20-2, cr. Tables 81.20-3e, 81.20-7e and 81.20-10m, am. Tables 81.20-4 to 81.20-8 and 81.20-11, r. Table 81.20-14, Register, December, 2000, No. 540, eff. 1-1-01; correction in (1) made under s. 13.93 (2m) (b) 7., Stats., Register, December, 2000, No. 540; CR 02-002: r. and recr. Register April 2003 No. 568, eff. 5-1-03; CR 02-129: am Table 81.20-8 Register January 2004 No. 577, eff. 2-1-04; CR 04-035: am. Table 81.20-4 and 81.20-10m Register November 2004 No. 587, eff. 12-1-04; CR 07-100: cr. (4) Register September 2008 No. 633, eff. 10-1-08; CR 08-055: am. (1), Tables 81.20-1 to 81.20-9 and Tables 81.20-11 to 81.20-13, r. Table 81.20-10, renun. Table 81.20-10m to be Table 81.20-10 and am. Register February 2009 No. 638, eff. 3-1-09.

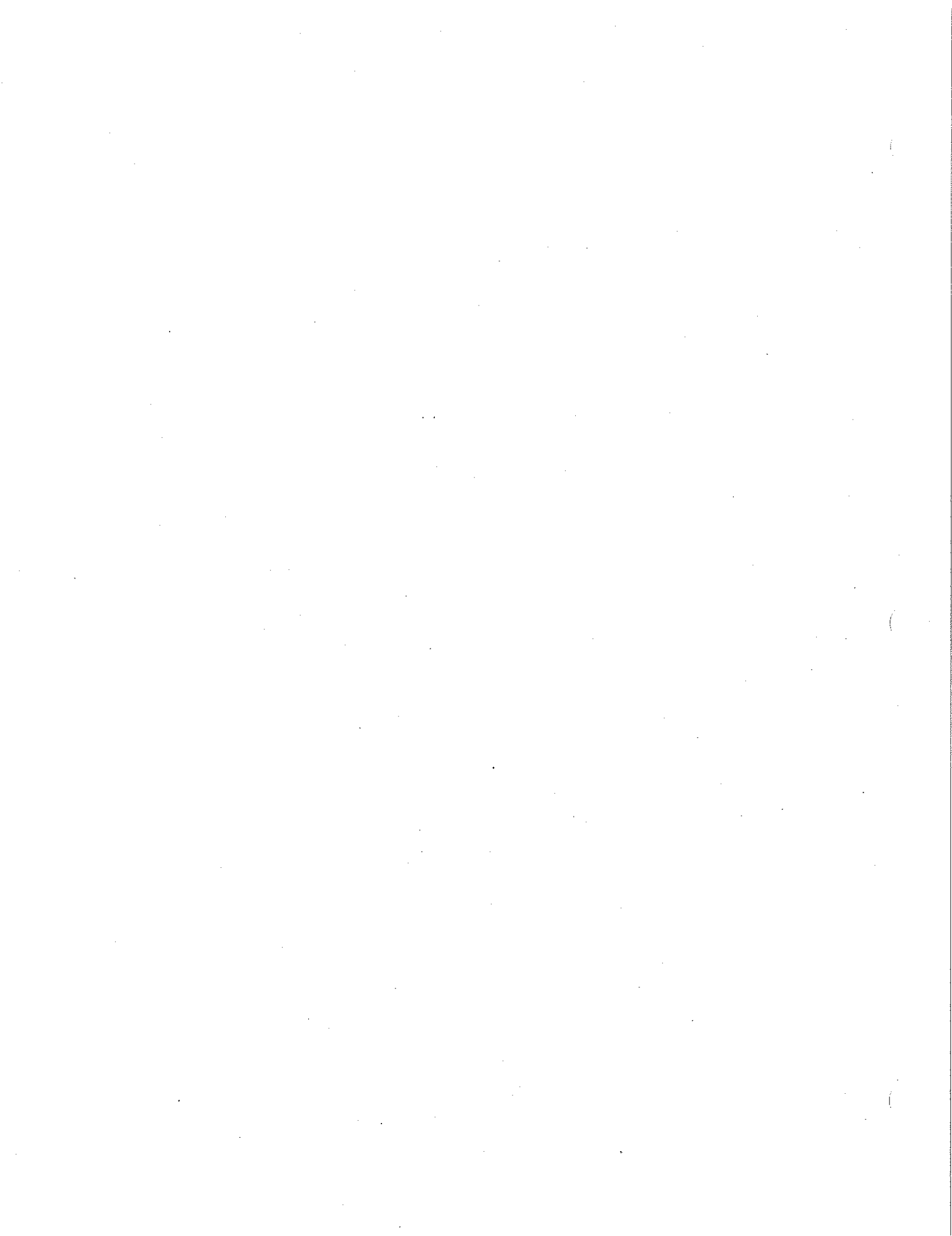

Chapter Comm 82

DESIGN, CONSTRUCTION, INSTALLATION, SUPERVISION, MAINTENANCE AND INSPECTION OF PLUMBING

Comm 82.01 Scope.
Comm 82.015 Purpose.
Comm 82.03 Application.

Subchapter I — Intent and Basic Requirements

Comm 82.10 Basic plumbing principles.

Subchapter II — Administration and Enforcement

Comm 82.20 Plan review and cross connection control assembly registration.
Comm 82.21 Testing and maintenance.

Subchapter III — Drain and Vent Systems

Comm 82.30 Sanitary drain systems.
Comm 82.31 Vents and venting systems.
Comm 82.32 Traps and direct fixture connections.
Comm 82.33 Indirect and local waste piping.
Comm 82.34 Wastewater treatment devices.

Comm 82.35 Cleanouts.
Comm 82.36 Stormwater and clear water drain systems.
Comm 82.37 Sanitation facilities and campgrounds.
Comm 82.38 Discharge points.

Subchapter IV — Water Supply Systems

Comm 82.40 Water supply systems.
Comm 82.41 Cross connection control.

Subchapter V — Special Plumbing Installations

Comm 82.50 Health care and related facilities.
Comm 82.51 Manufactured homes and manufactured home communities.

Subchapter VI — Installation

Comm 82.60 Pipe hangers and supports.

Subchapter VII — Plumbing Treatment Standards

Comm 82.70 Plumbing treatment standards.

Note: Sections ILHR 82.01 to 82.25, 82.15 and 82.17 to 82.25 as they existed on February 28, 1985 were repealed and new sections ILHR 82.01 to 82.36 and 82.51 and 82.60 were created effective March 1, 1985. Chapter ILHR 82 was renumbered chapter Comm 82 under s. 13.93 (2m) (b) 1., Stats. and corrections made under s. 13.93 (2m) (b) 7., Stats., Register, February, 1997, No. 494.

Comm 82.01 Scope. The provisions of this chapter apply uniformly to the design, construction, installation, supervision, maintenance and inspection of plumbing, including but not limited to sanitary and storm drainage, water supplies, wastewater treatment, and dispersal or discharge for buildings, except for POWTS systems as regulated by ch. Comm 83.

History: Cr. Register, February, 1985, No. 350, eff. 3-1-85; CR 02-002: am. Register April 2003 No. 568, eff. 5-1-03; CR 02-129: am. Register January 2004 No. 576, eff. 2-1-04.

Comm 82.015 Purpose. Pursuant to s. 145.02, Stats., the purpose of this chapter is to provide that all plumbing in connection with buildings and facilities in the state, including buildings owned by the state or any political subdivision thereof, shall be safe, sanitary and such as to safeguard the public health and the waters of the state.

History: CR 02-002: cr. Register April 2003 No. 568, eff. 5-1-03.

Comm 82.03 Application. (1) The provisions of this chapter are not retroactive, unless specifically stated otherwise in the rule.

(2) Pursuant to s. 145.13, Stats., this chapter is uniform in application and a municipality may not enact an ordinance for the design, construction, installation, supervision, maintenance and inspection of plumbing which is more stringent than this chapter, except as specifically permitted by rule.

(3) A department interpretation of the requirements in this chapter shall supersede any differing interpretation by a lower level jurisdiction. A department decision on the application of the requirements in this chapter shall supersede any differing decision by a lower level jurisdiction.

Note: A decision of the department may be appealed. Section 101.02 (6) (e), Stats., outlines the procedure for submitting requests to the department for appeal hearings and the department procedures for hearing appeals.

History: Cr. Register, February, 1985, No. 350, eff. 3-1-85; CR 02-002: renum. to be (1), cr. (2) Register April 2003 No. 568, eff. 5-1-03; CR 07-100: cr. (3) Register September 2008 No. 633, eff. 10-1-08.

Subchapter I — Intent and Basic Requirements

Comm 82.10 Basic plumbing principles. This chapter is founded upon basic principles of environmental sanitation and safety through properly designed, installed and maintained plumbing systems. Some of the details of plumbing construction

may vary, but the basic sanitary and safety principles desirable and necessary to protect the health of people are the same. As interpretations may be required and as unforeseen situations arise which are not specifically addressed, the following intent statements and basic requirements shall be used to evaluate equivalence where applicable:

(1) **INTENT.** (a) Plumbing in connection with all buildings, public and private, intended for human occupancy, shall be installed and maintained in such a manner so as to protect the health, safety and welfare of the public or occupants and the waters of the state.

(b) Plumbing fixtures, appliances and appurtenances, whether existing or to be installed, shall be supplied with water in sufficient volume and at pressures adequate to enable the fixtures, appliances and appurtenances to function properly and efficiently at all times and without undue noise under normal conditions of use. Plumbing systems shall be designed and adjusted to use the minimum quantity of water consistent with proper performance and cleaning.

(c) Devices for heating and storing water in pressure vessels or tanks shall be so designed and installed as to prevent dangers of explosion or overheating.

(d) Drain systems shall be designed, constructed and maintained so as to conduct the wastewater or sewage efficiently and shall have adequate cleanouts.

(e) The drain systems shall be so designed as to provide an adequate circulation of air in all pipes and no danger of siphonage, aspiration or forcing of trap seals under conditions of ordinary use.

(f) A plumbing system shall be of durable material, free from defective workmanship, and designed and constructed so as to provide satisfactory service for its reasonable expected life.

(g) Proper protection shall be provided to prevent contamination of food, water, sterile goods and similar materials by backflow of wastewater.

(h) All plumbing fixtures shall be installed so as to provide adequate spacing and accessibility for the intended use and cleaning.

(2) **BASIC REQUIREMENTS.** (a) Every building intended for human occupancy shall be provided with an adequate, safe and potable water supply.

(b) To fulfill the basic needs of sanitation and personal hygiene, each dwelling connected to a POWTS or public sewer shall be provided with at least the following plumbing fixtures: one water closet, one wash basin, one kitchen sink and one bathtub

or shower, except a system or device recognized under ch. Comm 91 may be substituted for the water closet. All other structures for human occupancy shall be equipped with sanitary facilities in sufficient numbers as specified in chs. Comm 60 to 66.

(c) Hot or tempered water shall be supplied to all plumbing fixtures that normally require hot or tempered water for proper use and function.

(d) Where plumbing fixtures exist in a building that is not connected to a public sewer system, suitable provision shall be made for treating, recycling, dispersing or holding the wastewater.

(e) Plumbing fixtures shall be made of durable, smooth, non-absorbent and corrosion resistant material, and shall be free from concealed fouling surfaces.

History: Cr. Register, February, 1985, No. 350, eff. 3-1-85; correction in (3) made under s. 13.93 (2m) (b) 7., Stats; am. (2), Register, August, 1991, No. 428, eff. 9-1-91; am. (3), Register, March, 1992, No. 435, eff. 4-1-92; r. (7) and renum. (8) to (15) to be (7) to (14), Register, February, 2000, No. 530, eff. 3-1-00; am. (2), (7) and (12), r. and recr. (3) and r. (14), Register, April, 2000, No. 532, eff. 7-1-00; CR 01-139; am. (3) Register June 2002 No. 558, eff. 7-1-02; CR 02-002; r. and recr. Register April 2003 No. 568, eff. 5-1-03; correction in (2) (b) made under s. 13.92 (4) (b) 7., Stats., Register February 2008 No. 626.

Subchapter II — Administration and Enforcement

Comm 82.20 Plan review and cross connection control assembly registration. (1) **GENERAL.** Plans and specifications shall be submitted to the department or to an approved agent municipality for review in accordance with pars. (a) and (b). All registrations for cross connection control assemblies shall be submitted to the department in accordance with par. (c).

Note: The department forms required in this chapter are available from the Safety and Buildings Division at P.O. Box 7162, Madison, WI 53707-7162, or at telephone (608) 266-3151 and (608) 264-8777 (TTY), or at the Safety and Buildings' web site at www.commerce.state.wi.us.

(a) **Department review.** When review is required, regardless of where the installation is to be located, written approval for the plans shall be obtained prior to installation of the work. The following types of installations shall be submitted to the department for review:

1. All types of installations listed in Table 82.20-1.
2. Treatment systems intended to be used to comply with the plumbing treatment standards as listed in Table 82.70-1, unless the treatment system is otherwise approved for that use as specified under s. Comm 82.20 (12), 84.10 or 84.50.

(b) **Department or agent municipality review.** 1. Plumbing plans and specifications for the types of plumbing installations listed in Table 82.20-2 shall be submitted for review to an agent municipality, if the installation is to be located within the agent municipality or to the department, if the installation is not to be located within an agent municipality. A municipality shall be designated as an agent municipality in accordance with sub. (2). Written approval for the plumbing plans shall be obtained prior to installation of the plumbing.

Note: For a listing of agent municipalities, see Appendix A-82.20 (2).

Note: The number of plumbing fixtures to be submitted and reviewed by an agent municipality is a subject of local ordinances.

2. Plan review and approval of one- and 2-family dwellings. Review and approval of plumbing plans for one- and 2-family dwellings shall be in accordance with the provisions specified in s. Comm 20.09.

(c) **Cross connection control assembly registration.** The initial installation of each reduced pressure principle backflow preventer, reduced pressure fire protection principle backflow preventer, spill resistant vacuum breaker, reduced pressure detector fire protection backflow prevention assembly or pressure vacuum breaker, shall meet all of the following:

1. a. Except as provided under subd. 1. b., for initial installation in any building or facility, each assembly covered under this paragraph shall be registered with the department.

b. Plan review approval for a cross connection control assembly issued prior to May 1, 2003 is considered in compliance with this paragraph.

2. For each assembly covered under this paragraph registration shall be submitted prior to the initial test.

Table 82.20-1

SUBMITTALS TO DEPARTMENT

Type of Plumbing Installation
1. Except for direct replacement, all plumbing, new installations, additions and alterations, regardless of the number of plumbing fixtures involved, to be installed in hospitals, nursing homes and ambulatory surgery centers. ^b
2. Plumbing, new installations, additions and alterations involving 16 or more plumbing fixtures, to be installed in connection with buildings owned by a metropolitan or sanitary sewer district. ^a
3. Plumbing, new installations, additions and alterations involving 16 or more plumbing fixtures, to be installed in connection with buildings owned by the state. ^a
4. Alternate and experimental plumbing systems.
5. For installation in health care and related facilities, reduced pressure principle backflow preventers and reduced pressure detector backflow preventers.
6. For installation in health care and related facilities, pressure vacuum breaker assembly.
7. For installation in health care and related facilities, spill resistant vacuum breaker.
8. Stormwater and clearwater infiltration plumbing systems serving a public building or facility. ^d
9. Plumbing wastewater reuse systems and stormwater use systems, other than POWTS, designed to treat water for compliance with Table 82.70-1. ^c

^a Water heaters, floor drains, storm inlets, roof drains and hose bibbs are to be counted as plumbing fixtures.

^b For hospitals, nursing homes and ambulatory care surgery centers, registration for cross connection control devices as specified under s. Comm 82.20 (1) is included as a part of plan approval.

^c For a product approved under s. Comm 84.10 or 84.50, the installation of such product does not constitute a system.

^d Agent municipalities may perform this review when so authorized by the department. For additional information, refer to Appendix.

Table 82.20-2

SUBMITTALS TO DEPARTMENT OR AGENT MUNICIPALITY

Type of Plumbing Installation
1. Except for direct replacement, new installations, additions and alterations to drain systems, vent systems, water service systems, and water distribution systems involving 16 or more plumbing fixtures to be installed in connection with public buildings. ^{a,b}
2. Grease interceptors to be installed for public buildings.
3. Garage catch basins, carwash interceptors and oil interceptors to be installed for public buildings and facilities.
4. Sanitary dump stations.
5. Piping designed to serve as private water mains.
6. Water supply systems and drain systems to be installed for manufactured home communities and campgrounds. ^c
7. Piping designed to serve as private interceptor main sewers greater than 4 inches in diameter when sized for gravity flow.
8. Chemical waste systems regardless of the number of plumbing fixtures. ^c

9. Stormwater systems, not including infiltration plumbing systems, serving a public building or facility where the drainage area is one acre or more.^d

^a Water heaters, floor drains, storm inlets, roof drains and hose bibbs are to be counted as plumbing fixtures. For a phased project such as a mall or office complex fixture count includes all proposed fixtures connected to a common building sanitary sewer, a common water service and all storm sewers serving the building.

^b For the purpose of plan submittal, public buildings do not include zero-lot-line row houses where each living unit is served by an individual water service and an individual building sewer.

^c Only agent municipalities which are cities of the first class may review these types of installations.

^d Plan review involving 16 or more plumbing fixtures also applies.

(2) AGENT MUNICIPALITIES. The department may designate to an approved municipality the authority to review and approve plumbing plans and specifications for those plumbing installations to be located within the municipality's boundary limits and which require approval under sub. (1) (b).

(a) An agent municipality shall employ at least 2 full time plumbing inspectors who have been qualified by the department.

1. The primary duties of the plumbing inspectors shall include plumbing plan review.

2. The plumbing inspectors shall be Wisconsin licensed master or journeyman plumbers.

Note: See Appendix for listing of agent municipalities.

(b) An agent municipality may waive its jurisdiction for plan review and approval for any project, in which case plans shall be submitted to the department for review and approval.

(c) Agent municipalities may set by ordinance the fees for plan review services.

(3) PRIORITY PLAN REVIEW. An appointment may be made with the department to facilitate the examination of plans in less than the normal processing time. Complete plans along with the fee specified in s. Comm 2.09, shall be submitted to the department. The plans shall comply with all of the provisions of this section.

(4) PLANS AND SPECIFICATIONS. (a) At least 2 sets of plans and one copy of specifications which are clear, legible and permanent copies shall be submitted for examination and approval.

(b) All plans submitted for approval shall be accompanied by sufficient data and information for the department to determine if the installation and its performance will meet the requirements of chs. Comm 81 to 84.

1. Information to accompany the plans shall include the location or address of the installation and the name of the owner.

2. Plans proposing the installation, creation or extension of a sanitary private interceptor main sewer which is to discharge to a municipal treatment facility shall:

a. Be accompanied by a letter from the appropriate designated planning or management agency indicating conformance with an approved areawide water quality management plan under ch. NR 121; and

b. Not be approved, if the municipality is ineligible for sanitary sewer extension approvals under s. NR 110.05.

Note: For plans proposing the installation, creation or extension of a private interceptor main sewer which is to discharge to a municipal treatment facility, see also ch. NR 121.

3. Except as provided in subd. 4., plans proposing the installation of a building sewer for new construction which is to discharge to a municipal treatment facility shall:

a. Be accompanied by a letter from either the appropriate designated management agency or sanitary district indicating conformance with an approved areawide water quality management plan; and

b. Not be approved, if the municipality is ineligible for sanitary sewer extension approvals under s. NR 110.05.

4. Plans proposing the installation of a building sewer for new construction which is to discharge to a municipal treatment facility shall not be required to comply with subd. 3., if:

a. The proposed installation is served by an existing building sewer which extends from the lot line to the public sewer and the proposed installation does not exceed the capacity of the existing building sewer or sewers; or

b. The plans indicate that a drainage load of not more than 54 drainage fixture units will be discharged through the building sewer.

Note: See Appendix for listing of water quality management agencies.

(c) Plumbing plans, index sheets and specifications for a plumbing system submitted for review and approval shall be signed in accordance with any of the following methods:

1. A Wisconsin registered architect, engineer or plumbing designer shall sign and seal or stamp all plans and accompanying specifications in accordance with ch. A-E 2.

2. A master plumber, master plumber-restricted service, master plumber-restricted appliance or a utility contractor shall sign and date all plumbing plans and accompanying specifications as provided under s. 145.06, Stats. Each sheet of plans and specifications submitted shall be signed and dated and shall include the valid Wisconsin license number of the individual responsible for the installation. Where more than one sheet is bound together into one volume, only the title sheet or index sheet shall be signed and dated by the individual responsible for the installation. The signed title or index sheet shall clearly identify all of the other sheets in the volume.

3. A pump installer shall sign and date all plumbing plans and accompanying specifications for which the individual is responsible for the installation. Each sheet of plans and specifications submitted shall be signed and dated and shall include the valid Wisconsin license number of the individual responsible for the installation. Where more than one sheet is bound together into one volume, only the title sheet or index sheet shall be signed and dated by the individual responsible for the installation. The signed title or index sheet shall clearly identify all of the other sheets in the volume.

(d) 1. When requesting approval of an experimental plumbing system, all of the following shall be submitted:

a. At least 2 sets of plans signed in accordance with par. (d) and detailing the system installation for each site.

b. A letter of consent from the site or system owner of the installation. The letter shall acknowledge that the owner has received and read a copy of the experimental plumbing system submittal and is in agreement with all requirements listed within this subdivision.

c. Any additional information as requested by the department.

2. The registered architect, engineer, designer or master plumber responsible for the design of the experimental plumbing system shall, upon completion, certify in writing to the department that the installation is in compliance with the approved plans, specifications and data.

3. Onsite inspections shall be performed by the department at time intervals as specified by the department, but not less than once a year. Time intervals shall be included as conditions of approval. An inspection report shall be written. The department may assess a fee for each inspection.

Note: Refer to ch. Comm 2 for applicable fees.

4. No later than five years after the date of the completed installation the department may perform one of the following:

a. Order the removal of the experimental plumbing system.

b. Issue an alternate approval as specified in sub. (12) (a).

c. Provide an extension of the experiment with conditions.

5. If an experimental plumbing system is subsequently codified in chs. Comm 82 and 84, or ch. 145, Stats., the requirements as specified in subds. 3. and 4. do not apply.

(5) **PLAN REVIEW.** Except as provided in sub. (12), and pursuant to s. Comm 2.07 (3), the department shall review and make a determination on an application for plan review within 15 business days.

(a) *Conditional approval.* If, upon review, the department determines that the plans substantially conform to the provisions of chs. Comm 82 to 84, a conditional approval, in writing, shall be granted. All noncode complying conditions stated in the conditional approval shall be corrected before or during installation.

(b) *Denial of approval.* If, upon review, the department determines that the plans do not substantially conform to the provisions of chs. Comm 82 to 84, the request of conditional approval shall be denied in writing.

(6) **EVIDENCE OF APPROVAL.** The plumber responsible for the installation of the plumbing shall keep at the construction site at least one set of plans bearing the department's or the agent municipality's stamp of approval and at least one copy of specifications. The plans and specifications shall be open to inspection by an authorized representative of the department.

(7) **FEES.** Fees for plumbing plan review and petition for variance shall be submitted in accordance with ss. Comm 2.64 and 2.52.

(8) **REVISIONS.** All changes or modifications, which involve the provisions of chs. Comm 82 to 84, made to plumbing plans and specifications, which have been granted approval under sub. (1), shall be submitted to the department or agent municipality for examination. All changes and modifications shall be approved in writing by the department or agent municipality prior to installation of the plumbing.

(9) **REVOCAION OF APPROVAL.** The department may revoke any approval, issued under the provisions of this chapter, for any false statements or misrepresentation of facts on which the approval was based.

(10) **DEPARTMENT LIMITATION AND EXPIRATION OF APPROVAL.** (a) A conditional approval of a plan by the department shall not be construed as an assumption by the department of any responsibility for the design; and the department does not hold itself liable for any defects in construction, nor for any damages that may result from the specific installation.

(b) Plan approval by the department or its authorized representative shall expire 2 years after the date indicated on the approval letter, if construction has not commenced within that 2 year period.

(11) **PETITION FOR VARIANCE.** (a) *Procedure.* The department shall consider and may grant a variance to a provision of this chapter in accordance with ch. Comm 3.

Note: Chapter Comm 3 requires the submittal of a petition for variance form (SBD-9890) and a fee, and that an equivalency is established in the petition for variance that meets the intent of the rule being petitioned. Chapter Comm 3 also requires the department to process regular petitions within 30 business days and priority petitions within 10 business days.

Note: Form SBD-9890-X is available on request at no charge from the department at the Safety and Buildings Division, P.O. Box 2509, Madison WI 53701-2509, telephone (608) 266-1818, S&B web address: <http://www.commerce.wi.gov/SB/SB-Forms.html/>.

(b) *Petition processing time.* Except for priority petitions, the department shall review and make a determination on a petition for variance within 30 business days of receipt of all calculations, documents and fees required to complete the review. The department shall process priority petitions within 10 business days.

Note: The petition for variance form (SBD-8) is available from the Safety and Buildings Division, P. O. Box 7162, Madison, WI 53707.

(12) **ALTERNATE AND EXPERIMENTAL PLUMBING SYSTEM REVIEW AND APPROVAL.** The provisions of this chapter, ch. Comm 84 or ch. 145, Stats., are not intended to prevent the design and use of approved innovative plumbing systems.

(a) *Alternate plumbing systems.* The department may issue an approval of an alternate plumbing system if the system complies with the intent of chs. Comm 82 and 84, or ch. 145, Stats.

1. For an alternate plumbing system, before availability for statewide installation and use, an alternate plumbing system approval shall be issued. Concepts, plans, specifications and the documentation to support the system design shall be submitted to the department for review.

2. The department may require the submission of any information deemed necessary for review. Sufficient evidence shall be submitted to substantiate at least the following:

a. Assertions of function and performance.

b. Compliance with the intent of chs. Comm 82 and 84, or ch. 145, Stats.

3. Pursuant to s. Comm 2.07 (3), the department shall review and make a determination on an application for an alternate plumbing system within 3 months. Approval for an alternate plumbing system shall be issued by the department in writing.

4. The department may include specific conditions in issuing an approval for an alternate plumbing system, including an expiration date for the approval. A violation of any of the conditions under which an approval is issued shall constitute a violation of this chapter.

5. If upon review the department determines that an alternate plumbing system does not comply with the intent of chs. Comm 82 and 84, or ch. 145, Stats., the request for approval shall be denied in writing.

(b) *Experimental plumbing systems.* The department may issue an approval of an experimental plumbing system for the purpose of proving compliance with the intent of chs. Comm 82 and 84 and ch. 145, Stats.

1. For an experimental plumbing system, a separate approval shall be obtained for each system or project to be installed for the purpose of proving compliance with the intent of chs. Comm 82 and 84 and ch. 145, Stats. Approval for an experimental plumbing system shall be issued by the department in writing.

2. The department may require the submission of additional information deemed necessary for determining that the design meets the intent of chs. Comm 82 and 84 and ch. 145, Stats.

3. Pursuant to s. Comm 2.07 (3), the department shall review and make a determination on an application for an experimental plumbing system within 6 months.

4. The department may include specific conditions in issuing an approval for an experimental plumbing system, including an expiration date for the approval. A violation of any of the conditions under which an approval is issued shall constitute a violation of this chapter.

5. Denial of an experimental plumbing system or project by the department shall be made in writing.

6. The department may establish parameters to limit the number of applications for review it will accept for experimental plumbing systems.

(c) *Modification.* If an approved alternate or experimental plumbing system is modified or additional assertions of function or performance are made, the approval shall be void, unless the system is resubmitted to the department for review and approval is granted.

(d) *Revocation of approval.* The department may revoke an approval issued under this section for any false statements or misrepresentations of facts or data on which the approval was based, or as a result of system failure.

(e) *Limitations.* An approval issued by the department for an alternate or experimental plumbing system may not be construed as an assumption of any responsibility for defects in design, construction or performance of any system nor for any damages that may result.

(f) *Fees.* Fees for the review of an alternate or experimental plumbing system under this section and any onsite inspections shall be submitted in accordance with ch. Comm 2.

(13) CROSS CONNECTION CONTROL REGISTRATION. (a) Registration, as specified in sub. (1) (c), shall be submitted in a format acceptable to the department.

Note: The forms required in this chapter are available from the Safety and Buildings Division, P.O. Box 7162, Madison, WI 53707-7162, or at telephone (608) 266-3151 and (608) 264-8777 (TTY), or at the Safety and Buildings' web site at www.commerce.state.wi.us.

(b) The form for registering cross connection control devices and assemblies with the department shall include at least all of the following information:

1. The building or facility name and address where the device or assembly is or will be installed.
2. The location of the cross connection control device or assembly within the building or facility.
3. A description of the cross connection control device or assembly including the size, model number, serial number and manufacturer.
4. The name of the owner or owner's agent submitting the registration form and contact information.

(c) Each registration form submitted shall be accompanied by the appropriate fee in accordance with s. Comm 2.645.

(d) Upon receipt of a completed registration form, the department shall issue written confirmation of registration including a department assigned identification number for each cross connection control device or assembly.

(e) Upon permanent removal or replacement of any reduced pressure principle backflow preventer, reduced pressure fire protection principle backflow preventer, spill resistant vacuum breaker, reduced pressure detector fire protection backflow prevention assembly, or pressure vacuum breaker, the owner shall notify the department in writing using a format acceptable to the department.

(14) PENALTIES. Penalties for violations of this chapter shall be assessed in accordance with s. 145.12, Stats.

History: Cr. Register, February, 1985, No. 350, eff. 3-1-85; am. (1) (intro.), r. and recr. Tables 82.20-1 and 82.20-2, r. (5), renum. (6) to (12) to be (5) to (11), cr. (5) (intro.) and (12), Register, May, 1988, No. 389, eff. 6-1-88; correction in (1) (b) 1. made under s. 13.93 (2m) (b) 7., Stats., Register, May, 1988, No. 389; am. (4) (c) 2, intro. and 4. a. and b., Register, February, 1991, No. 422, eff. 3-1-91; am. (4) (c) 3.a., Register, August, 1991, No. 428, eff. 9-1-91; am. (1) (intro.), (a), (4) (a) to (c) 1., (5) (a), (b) and Tables 82.20-1 and 82.20-2, renum. (4) (d) and (e) to be (4) (d) 1. a. and b. and am. (4) (d) 1. a., cr. (4) (d) 2., Register, February, 1994, No. 458, eff. 3-1-94; correction in (7) made under s. 13.93 (2m) (b) 7., Stats., Register, February, 1994, No. 458; corrections made under s. 13.93 (2m) (b) 7., Stats., Register, October, 1996, No. 490; am. Tables 82.20-1, 2, (1) (b) 2., Register, February, 1997, No. 494, eff. 3-1-97; correction in (13) made under s. 13.93 (2m) (b) 7., Stats., Register, February, 2000, No. 530; am. Tables 82.20-1 and 82.20-2, r. (4) (b), Register, July, 2000, No. 535, eff. 9-1-00; cr. (4) (e), r. and recr. (11) and (12), am. Table 82.20-1, Register, December, 2000, No. 540, eff. 1-1-01; CR 02-002: am. (1) (intro.) and Tables 82.20-1 and 82.20-2, r. and recr. (1) (a), r. (1) (b) 2. and (4) (d), renum. (1) (b) (intro.), and 1., (4) (c), (e) and (13) to be (1) (b) 1. and 2., (4) (b), (d) and (14) and am. (4) (b) (intro.) and 2. (intro.), cr. (1) (c), (4) (c) and (13) Register April 2003 No. 568, eff. 5-1-03; CR 02-129: am. (title), (1) (intro) and (c), and (13) (e) Register January 2004 No. 577, eff. 2-1-04; CR 04-035: am. Tables 82.20-1 and 82.20-2 Register November 2004 No. 587, eff. 12-1-04; CR 06-119: am. (5) (intro.), (12) (a) 3. and (b) 3. Register July 2007 No. 619, eff. 8-1-07; CR 08-055: am. (1) (c) (intro.), (4) (b) 2. (intro.), (13) (e), Tables 82.20-1 and 82.20-2 Register February 2009 No. 638, eff. 3-1-09; correction in (3) made under s. 13.92 (4) (b) 7., Stats., Register February 2009 No. 638.

Comm 82.21 Testing and inspection. (1) **TESTING OF PLUMBING SYSTEMS.** Except as provided in par. (a), all new plumbing and all parts of existing systems which have been altered, extended or repaired shall be tested as specified in sub. (2) to disclose leaks and defects before the plumbing is put into operation.

(a) **Waiver of testing.** 1. The testing of the plumbing shall not be required where the installation does not include the addition, replacement, alteration or relocation of any water distribution, drain or vent piping.

2. a. Field testing the installation of a storm building sewer and a storm private interceptor main sewer is not required.

b. The joints and connections to be employed for storm building sewer piping shall conform with s. Comm 84.40 (1) (a).

(b) **Local inspection.** Where the plumbing is installed in a municipality having a local inspector, the testing of the plumbing

shall be done in the presence of a plumbing inspector, except as provided in subd. 1. b.

1. 'Notice of inspection.' a. The plumber responsible for the installation shall notify the plumbing inspector in person, by telephone or in writing when the work is ready for inspection.

b. Testing may be done without the presence of the inspector, if the master plumber responsible for the installation obtains the inspector's permission to provide a written test report in a format acceptable to the inspector.

Note: See the appendix for a sample affidavit form.

2. 'Preparations for inspection.' When the installation is ready for inspection, the plumber shall make such arrangements as will enable the plumbing inspector to inspect all parts of the plumbing system. The plumber shall have present the proper apparatus and appliances for making the tests, and shall furnish such assistance as may be necessary in making the inspection.

3. 'Rough-in inspection.' A rough-in inspection shall be made when the plumbing system is roughed-in and before fixtures are set. Except as provided in subd. 1., plumbing work shall not be closed in, concealed, or covered until it has been inspected and approved by the plumbing inspector and permission is granted to do so.

4. 'Final inspection.' a. Upon completion of the plumbing installation and before final approval is given, the plumbing inspector shall inspect the work.

b. Municipalities may require that a final test be conducted in accordance with sub. (2) (h) and that the final test, when required by the municipality, shall be observed by the plumbing inspector.

5. 'Reinspections.' Whenever the plumbing official finds that the work or installation does not pass any initial test or inspection, the necessary corrections shall be made to comply with this chapter. The work or installation shall then be resubmitted for inspection to the plumbing inspector.

(c) **Inspection of one- and 2-family dwellings.** The inspection of plumbing installations for one- and 2-family dwellings shall be in accordance with ss. Comm 20.08 to 20.11.

(2) **TESTING PROVISIONS.** (a) **General.** The testing of plumbing installations shall be conducted in accordance with this paragraph.

1. 'Equipment, material and labor for tests.' All equipment, material and labor required for testing a plumbing system or part thereof shall be furnished by the plumber responsible for the installation.

2. 'Exposure of work.' Except as provided in pars. (b) and (e), all new, altered, extended or replaced plumbing shall be left uncovered and unconcealed until it has been tested. Where the work has been covered or concealed before it is tested, it shall be exposed for testing.

(b) **Sanitary building sewer and sanitary private interceptor main sewer.** A sanitary building sewer and a sanitary private interceptor main sewer shall be tested for leaks and defects with water or air before or after being covered in accordance with either subd. 1. or 2. The test for leaks and defects may be applied to the entire building sewer or private interceptor main sewer or in sections. For the purposes of this subdivision, the testing of a building sewer or private interceptor main sewer is not required to include the manholes serving the sewer.

1. The building sewer or private interceptor main sewer shall be tested by insertion of a test plug at the point of connection with the public sewer. The sewer shall then be filled with water under a head of not less than 10 feet. The water level at the top of the test head of water shall not drop for at least 15 minutes.

2. The air test shall be made by attaching an air compressor testing apparatus to any suitable opening, and, after closing all other inlets and outlets to the system, forcing air into the system until there is a uniform gauge pressure of 3 pounds per square inch. This pressure shall be held without introduction of additional air for a period of at least 15 minutes.

(c) *Building drain.* The entire building drain with all its branches, receptacles and connections shall be brought so far as practical to the surface or grade of the basement floor and shall be tested with water or air in accordance with par. (g).

(d) *Drain and vent systems.* The piping of a drain and vent systems, including conductors, shall be tested upon completion of the rough piping installation with water or air in accordance with par. (g).

(e) *Private water mains and water services.* Private water mains and water services shall be inspected before being covered. The private water mains and water services shall be tested and proven water tight under water pressure not less than the working pressure under which it is to be used. The water used for testing shall be obtained from a potable source of supply.

Note: Standard NFPA 24 for combination water services and combination private water mains may include more stringent requirements for testing.

(f) *Water distribution system.* The piping of a water distribution system shall be tested and proved water tight under a water pressure not less than the working pressure under which it is to be used. The water used for tests shall be obtained from a potable source of supply.

(g) *Test methods for drain and vent systems.* A test for watertightness shall be applied to the entire drain and vent system at one time or to the entire system in sections after the rough piping has been installed in accordance with either subd. 1. or 2.

1. If applied to the entire system, all openings in the piping shall be tightly closed, except the highest opening, and the system shall be filled with water to the point of overflow. If the system is tested in sections, each opening shall be tightly plugged except the highest opening of the section under test, and each section shall be filled with water, but a section shall not be tested with less than a 10 foot head of water. In testing successive sections, at least the upper 10 feet of the next preceding section shall be tested, so that no joint or pipe in the building, except the uppermost 10 feet of the system, is subjected to a test of less than a 10 foot head of water. The water shall be kept in the system or in the portion under test for at least 15 minutes before inspection starts. The system shall then be tight at all points.

2. The air test shall be made by attaching an air compressor testing apparatus to any suitable opening, and, after closing all other inlets and outlets to the system, forcing air into the system until there is a uniform gauge pressure of 5 pounds per square inch or sufficient to balance a column of mercury 10" in height. This pressure shall be held without introduction of additional air for a period of at least 15 minutes.

(h) *Final test.* Where required by the local plumbing inspector, after the plumbing fixtures have been installed and the traps filled with water, the connections shall be tested and proved gas and watertight by either one of the methods specified in subd. 1. or 2.

1. The smoke test shall be made by introducing a pungent, thick smoke, produced by one or more smoke machines, into the completed system. When the smoke appears at stack openings on the roof, the openings shall be closed and a pressure equivalent to a one inch water column shall be built and maintained for the period of the inspection.

2. The air test shall be made by attaching a gauge to any suitable opening and, after closing all other inlets and outlets in the system, adding air into the system until a pressure equivalent to a one inch water column exists. The pressure shall remain constant for at least a 5-minute test period without the introduction of additional air.

History: Cr. Register, February, 1985, No. 350, eff. 3-1-85; r. and recr. (1) (d) 5., am. (1) (d) 7. intro., Register, May, 1988, No. 389, eff. 6-1-88; correction in (1) (c) made under s. 13.93 (2m) (b) 7., Stats., Register, May, 1988, No. 389; renum. (1) (a) and (2) (b) to (i) to be (1) (a) 1. and (2) (a) to (h), r. (2) (a), cr. (1) (a) 2. and (3), r. and recr. (1) (d) 1. (intro.), am. (1) (d) 2. (intro.), Register, February, 1994, No. 458, eff. 3-1-94; am. (3) (b) 3., Register, October, 1996, No. 490, eff. 11-1-96; am. (3), Register, February, 1997, No. 494, eff. 3-1-97; r. and recr. (2) (a) and (3), cr. Table 82.21-1, Register, December, 2000, No. 540, eff. 1-1-01; CR 02-002: r. and recr. (1) (b) 4. b. and (2) (d), am. (1) (d) 8. b. Register April 2003 No. 568, eff. 5-1-03; CR 04-035: am. Table 82.21-1 Register November 2004 No. 587, eff. 12-1-04; CR

08-055: am. (title) and (1) (intro.), r. and recr. (1) (b) 1. b., r. (2) and Table 82.21-1, renum. (1) (d) and (3) to be (2) and Comm 82.22 (9) Register February 2009 No. 638, eff. 3-1-09; corrections in (1) (b) 4. b., (2) (a) 2., (b) (intro.), (c), (d), (g) (intro.) and (h) (intro.) made under s. 13.92 (4) (b) 7., Stats., Register February 2009 No. 638.

Comm 82.22 Maintenance and repairs. (1) GENERAL.

(a) All plumbing systems, both existing and new, and all parts thereof, shall be maintained in a safe and sanitary condition.

(b) All devices or safeguards that are required by this chapter shall be maintained in good working order.

(c) The owner shall maintain plumbing systems.

(2) EXISTING SYSTEMS. (a) Except as specified in par. (b), any existing plumbing system may remain and maintenance continue if the maintenance is in accordance with the original system design and any of the following:

1. The plumbing system was installed in accordance with the code in effect at the time of installation.

2. The plumbing system conforms to the present code.

(b) When a hazard to life, health or property exists or is created by an existing system, that system shall be repaired or replaced.

Note: A cross connection is considered a health hazard by the department.

(c) Existing sewers and water services may only be connected to new buildings when determined by examination and test to conform to the requirements of this chapter.

(3) FIXTURES REPLACED. (a) When a fixture, appliance or section of pipe is replaced, the replacement fixture, appliance or pipe shall conform to the provisions of this chapter.

(b) Where the existing drain or vent piping does not conform to the current provisions of this chapter, the department may require the new fixtures to be provided with deep seal traps.

(4) PLUMBING REUSED. (a) 1. Except as provided in par. (b) plumbing materials, fixtures or devices removed and found to be in good condition may be reused if such reuse is approved by the department or a local plumbing inspector.

2. The owner of the building or facility in which the reused materials are to be installed shall provide written consent.

(b) Water supply piping materials may only be reused when the intended use involves an equal or higher degree of hazard than the previous use as specified in Table 82.70-1.

(5) REPAIRS. All repairs to fixtures, devices or piping shall be completed in conformance with the provisions of this chapter, except repair clamps or bands may be used for emergency situations.

(6) DEMOLITION OF STRUCTURES. When a structure is demolished or removed, all sanitary sewer, storm sewer and water supply connections shall be sealed and plugged in a safe manner.

(7) DEAD ENDS. If a dead end is created in the removal of any part of a drain system, all openings in the drain system shall be properly sealed.

(8) TESTING OF CROSS CONNECTION CONTROL ASSEMBLIES. (a) The performance testing requirements of this subsection apply to all cross connection control assemblies regardless of date of installation.

Note: For further clarification see Table 82.22-1.

(b) 1. A performance test shall be conducted for the assemblies listed in Table 82.22-1 at all of the following intervals:

a. At the time of installation.

b. Immediately after repairs or alterations to the assembly have occurred.

c. At least annually.

2. The performance test shall be conducted using the appropriate test standard for the assembly as specified in Table 82.22-1.

3. A cross connection assembly performance test shall be conducted by an individual registered by the department in accordance with s. Comm 5.99.

4. a. The results of the cross connection control assembly performance test shall be submitted as specified in Table 82.22-1 in a format prescribed by the department.

b. As specified in Table 82.22-1, the results of the cross connection assembly performance test shall be submitted to the department and purveyor within 60 days of completion of the test.

5. The results of performance tests for the assemblies listed in Table 82.22-1 shall be made available upon request to the department, its agent or the local government unit.

(9) MAINTENANCE AND TESTING OF CROSS CONNECTION CONTROL DEVICES. (a) The maintenance and performance testing requirements of this subsection apply to all cross connection control devices regardless of date of installation.

Note: For further clarification, see Table 82.21-1.

(b) 1. A performance test shall be conducted for the devices listed in Table 82.21-1 at all of the following intervals:

- a. At the time of installation.
- b. Immediately after repairs or alterations to the device have occurred.
- c. At least annually.

2. The performance test shall be conducted using the appropriate test standard for the device as specified in Table 82.21-1.

3. A cross connection device performance test shall be conducted by an individual registered by the department in accordance with s. Comm 5.99.

4. a. The results of the cross connection device performance test shall be submitted as specified in Table 82.21-1 in a format prescribed by the department.

Note: Test results shall be submitted on the Cross Connection Control Device Performance Test form (SBD-9927), available on request from the department at the Safety and Buildings Division, P.O. Box 7302, Madison WI 53707-7302; Fax (608) 267-0592, S&B web address: <http://www.commerce.state.wi.us/SB/SB-Forms.html>.

b. As specified in Table 82.21-1, the results of the cross connection device performance test shall be submitted to the department and purveyor within 60 days of completion of the test.

5. The results of performance tests for the devices or assemblies listed in Table 82.21-1 shall be made available upon request to the department, its agent, or the local governmental unit.

(c) The maintenance and performance testing requirements of this subsection shall also apply to those cross connection control devices or assemblies installed prior to the effective date of this subsection.

**TABLE 82.22-1
TESTING AND SUBMITTING REQUIREMENTS FOR CROSS CONNECTION CONTROL ASSEMBLIES**

ASSE Standard Name and Number	CAN/CSA Standard Name and Number	ASSE Test Standard Number and Test Required	Test Results to be Submitted to Department and Purveyor
Double Check Backflow Prevention Assemblies and Double Check Fire Protection Backflow Prevention Assemblies ASSE 1015	Double Check Valve Backflow Preventers and Double Check Valve Backflow Preventers For Fire Protection Systems CAN/CSA-B64.5.1	5015	No
Double Check Detector Fire Protection Backflow Prevention Assemblies ASSE 1048	-----	5048	No
Pressure Vacuum Breaker Assembly ASSE 1020	Pressure Vacuum Breakers CAN/CSA-B64.1.2	5020	Yes
Reduced Pressure Principle Backflow Preventers and Reduced Pressure Fire Protection Principle Backflow Preventers ASSE 1013	Reduced Pressure Principle Backflow Preventers and Reduced Pressure Principle Backflow Preventers For Fire Protection Systems CAN/CSA-B64.4	5013	Yes
Reduced Pressure Detector Fire Protection Backflow Prevention Assemblies ASSE 1047	-----	5047	Yes
Spill Resistant Vacuum Breaker ASSE 1056	Spill Resistant Vacuum Breakers CAN/CSA B64.1.3	5056	Yes

History: CR 08-055; cr. (1) to (8) and Table 82.22-1, (9) renun. from Comm 82.21 (3) Register February 2009 No. 638, eff. 3-1-09; correction to numbering in (3) made under s. 13.92 (4) (b) 1., Stats., Register February 2009 No. 638.

Subchapter III — Drain and Vent Systems

Comm 82.30 Sanitary drain systems. (1) SCOPE. The provisions of this section set forth the requirements for the design and installation of sanitary drain systems, including building drains and building sewers.

Note: The provisions for storm and clear water drain systems are specified in s. Comm 82.36.

(2) MATERIALS. All sanitary drain systems shall be constructed of approved materials in accordance with ch. Comm 84.

(3) LOAD ON DRAIN PIPING. (a) *Intermittent flow.* 1. 'Fixture.' The load factor on drain piping shall be computed in terms of drainage fixture unit values specified in Table 82.30-1 for the corresponding listed fixture.

2. 'Devices.' Drainage fixture unit values for intermittent flow devices not listed in Table 82.30-1 shall be computed on the basis of one fixture unit equalling one gallon per minute of flow.

Note: Equipment with a timed discharge cycle(s) of 2 minutes or less may be considered as an intermittent flow device.

(b) *Continuous flow devices.* Drainage fixtures unit values for continuous flow devices such as pumps, ejectors, air conditioning equipment or similar devices that discharge continuously shall be computed on the basis of 2 fixture units for each one gallon per minute of flow.

**TABLE 82.30-1
DRAINAGE FIXTURE UNIT VALUES BY FIXTURE TYPE**

Type of Fixture	Drainage Fixture Unit Value (dfu)	Trap Size Minimum Diameter (inches)
Automatic Clothes Washers:		
Commercial, individual	4	2
Commercial, large capacity	a	a
Self Service Laundry	4	2
Residential	4	2
Autopsy Table	h	h
Bathroom Group, includes: water closet, lavatory, bathtub or shower	6	
Bathtubs, all types ^b	2	1½
Bedpan Washer	6	2
Beer Tap	½	1¼
Bidet	2	1½
Bottle Cooler	½	1¼
Campsite Receptor	6	4
Coffee Maker	½	1¼
Cuspidor, fountain or dental	1	1¼
Dipper Well	1	1¼
Dishwasher, commercial type	c	c
Dishwasher, residential type	2	1½
Drinking Fountain	½	1¼
Exhaust Hood Washer	4	2
Floor Drain:		
2 inch	2	2
3 inch	3	3
4 inch	4	4
Larger than 4 inch	4	d
Glass Filler	½	1¼
Glass Washer	2	1½
Health Care Fixtures:		
Clinic sink	6	NA
Exam/treatment sink	1	1¼
Sitz bath	2	1½
Ice Chest	½	1½
Laundry Tray, 1 or 2 compartment	2	1½
Lavatory	1	1¼
Lavatory, combination per trap	1	1½
Manufactured Home	11	NA
Refrigerated Food Display Case	1	1
Shower Stall:		
Residential	2	2
Public, individual	2	2
Public, group	2 per shower head	2
Sinks:ⁱ		
Bar, residential	1	1¼
Breakroom (single compartment)	1	1½
Cup	½	1¼
Factory, wash, per set of faucets	1	1½

**TABLE 82.30-1 (Continued)
DRAINAGE FIXTURE UNIT VALUES BY FIXTURE TYPE**

Type of Fixture	Drainage Fixture Unit Value (dfu)	Trap Size Minimum Diameter (inches)
Fountain wash up	1	1½
Fountain or Bar, 4 compartments or less	3	1½
Food Waste Grinder, commercial 2 HP or less	2	f
Food Waste Grinder, commercial 3 HP or more	3	f
Laboratory	2	1½
Laboratory, school	2	1½
Classroom	1	1¼
Pack or plaster	3	2
Residential, with or without food waste grinder	2	1½
Restaurant, Scullery, pots and pans — 4 compartments or less	3	f
Food, rinsing, cleaning or thawing	3	2
Service Sink, Flushing Rim	6	3
Service Sink, 2 inch diameter, wall outlet	2	2
Service Sink, 3 inch diameter, wall outlet	3	3
Service Sink, 2 inch diameter, floor outlet	2	2
Service Sink, 3 inch diameter, floor outlet	3	3
Shampoo Sink, barber or beauty parlor	2	1½
Surgeons, wash up	3	1½
Wash Fountain, circular and semi-circular	2	1½
Receptors of Indirect Wastes, gravity flow discharge:		
1¼ inch receptor outlet diameter	1	1¼
1½ inch receptor outlet diameter	2	1½
2 inch receptor outlet diameter	3	2
3 inch receptor outlet diameter	4	3
4 inch receptor outlet diameter	6	4
Larger than 4 inch receptor outlet diameter	8	f
Soda Dispenser	½	1¼
Sterilizers:		
Bedpan	4	2
Garbage can washer	3	3
Instrument or water	1	
Urinal	2	g
Water Closet, nonpublic	4	g
Water Closet, public	6	g

NA = not applicable

^a Based on discharge rate of the fixture.

^b Includes foot, sitz and infant baths and regular bathtubs with or without showers or whirlpool circulation piping.

^c Based on discharge rates and number of outlets; a 4" diameter trap and drain pipe minimum recommended.

^d Trap size corresponds to the size of the floor drain.

^e Trap size corresponds to the size of the drain outlet.

^f Trap size specified in referenced standards of s. Comm 84.20.

^g Trap size corresponds to the size of the drain outlet. Use the dfu value of the receptor serving the autopsy table.

ⁱ Sinks not specified in this table shall be assigned 1 dfu for 1¼" tailpiece, 2 dfu for 1½" tailpiece and 3 dfu for 2" tailpiece.

Table 82.30-2
HORIZONTAL AND VERTICAL DRAIN PIPING

Pipe Diameter (inches)	Maximum Number of Drainage Fixture Units That May Drain Through Any Portion of Horizontal and Vertical Drain Piping			
	Horizontal Drain Piping ^a	Vertical Drain Piping ^b		
		Total Discharge from Side Connections into One Branch Interval	Vertical Drain Piping of 3 Branch Intervals or Less	Vertical Drain Piping of More Than 3 Branch Intervals
1 ¼	1	1	2	2
1 ½	3	2	4	8
2	6	6	10	24
3	20	20	48	72
4	160	90	240	500
5	360	200	540	1,100
6	620	350	960	1,900
8	1,400	600	2,200	3,600
10	2,500	1,000	3,800	5,600
12	3,900	1,500	6,000	8,400
15	7,000	c	c	c

^a Does not include building drains and building sewers.

^b Drain stacks may be reduced in size as the drainage load decreases to a minimum diameter of one half of the diameter required at the base of the stack, but not smaller than that required for a stack vent under s. Comm 82.31 (14) (a).

^c Sizing based on design criteria.

Table 82.30-3
BUILDING DRAINS, BUILDING SUBDRAINS, BUILDING SEWERS AND PRIVATE INTERCEPTOR MAIN SEWERS^a

Pipe Diameter (inches)	Maximum Number of Drainage Fixture Units Which May Drain Through Any Portion of a Building Drain, Building Subdrain, Building Sewer or Private Interceptor Main Sewer			
	Pitch (inch per foot)			
	1/16	1/8	1/4	1/2
1 ¼	NP ^b	NP	1	1
1 ½	NP	NP	3	3
2	NP	NP	6	9
3	NP	36	42	50
4	NP	180	216	250
5	NP	390	480	575
6	NP	700	840	1,000
8	1,400	1,600	1,920	2,300
10	2,500	2,900	3,500	4,200
12	3,900	4,600	5,600	6,700
15	7,000	8,300	10,000	12,000

^a Private interceptor main sewers 6 inches or less in diameter, see s. NR 110.13 for private interceptor main sewers 8 inches or larger in diameter.

^b NP means Not Permitted.

Note: For further explanatory material see Appendix A-82.30 (4).

(4) SIZE OF DRAIN PIPING. (a) *Maximum loading.* 1. The total drainage load in any portion of drain piping shall not exceed the limits specified in Tables 82.30-2 and 82.30-3.

2. The drainage fixture unit values assigned to a receptor which is to receive only the indirect waste discharge from a relief valve on a domestic water heater may be disregarded when determining the minimum size of the building drain and building sewer. Any drain piping between the receptor and the building drain shall be sized by including the assigned fixture unit values for the type of receptor.

Note: See s. Comm 82.31 (17) for sizing requirements of combination drain and vent systems.

Note: See Appendix for further explanatory material.

(b) *Minimum size of building sewers.* 1. Gravity flow sewers. The minimum size of a gravity flow sanitary building sewer shall be 4" in diameter. A municipality or sanitary district by ordinance may require that portion of the building sewer between the lot line and the public sewer to be larger than 4" in diameter.

2. Pressurized sewers. a. Sewers pressurized through the use of sewage ejectors, sewage pumps or sewage grinder pumps shall be sized to maintain a minimum flow velocity of 2 feet per second and shall be in accordance with the ejector or pump manufacturer's recommendations.

b. Pressurized building sewers shall be sized not less than 2" in diameter for sewage ejectors and sewage pumps, and 1 1/4" in diameter for all sewage grinder pumps.

(c) *Minimum size of private interceptor main sewers.* 1. Except as provided in subd. 3., the minimum size of a gravity flow private interceptor main sewer shall be 4" in diameter.

2. Except as provided in subd. 3., the minimum size of pressurized private interceptor main sewer shall be such so as to maintain a minimum flow velocity of 2 feet per second.

3. A municipality or a sanitary district may by ordinance, require the minimum size of a private interceptor main sewer to be larger than 4" in diameter.

4. Private interceptor main sewers 6" or less in diameter may not exceed the drainage fixture limits in Table 82.30-3.

5. Private interceptor main sewers 8" or larger in diameter shall conform with the design criteria specified in s. NR 110.13.

Note: See Appendix A-82.30 (4) for further explanatory material.

(d) *Future fixtures.* Where provisions are made for the future installation of fixtures, the drainage fixture unit values of such fixtures shall be considered in determining the required sizes of drain and vent pipes. Construction to provide for future installations shall be terminated with a plugged fitting or fittings.

(5) PITCH OF HORIZONTAL DRAIN PIPING. All horizontal drain piping 4" or larger in diameter shall be installed at a pitch which produces a computed velocity of at least 2 feet per second when flowing half full.

(a) *Horizontal branch drains.* 1. The minimum pitch of horizontal branch drains 2" or less in diameter shall be 1/4" per foot.

2. The minimum pitch of horizontal branch drains larger than 2" in diameter shall be 1/8" per foot.

(b) *Building drains and building sewers.* 1. The minimum pitch of building drains shall be in accordance with Table 82.30-3.

2. a. The minimum pitch of building sewers 10" or less in diameter shall be in accordance with Table 82.30-3.

b. The minimum pitch of building sewers 12" or larger in diameter shall conform with the minimum pitch specified for municipal sewers in s. NR 110.13.

Note: See also s. Comm 82.30 (4) (c) 5. for further explanatory material.

(c) *Private interceptor main sewers.* 1. The minimum pitch of private interceptor main sewers 6" or less in diameter shall be in accordance with Table 82.30-3.

2. The minimum pitch of private interceptor main sewers 8" or larger in diameter shall conform with the minimum pitch specified for municipal sewers in s. NR 110.13.

Note: See Appendix for further explanatory material.

(6) OFFSETS IN VERTICAL DRAINS. Offsets in vertical drain piping shall be in accordance with this subsection.

(a) *Offsets of 45° or less.* 1. An offset in a vertical drain, with a change in direction of 45° or less from the vertical, shall be sized as a vertical drain piping in accordance with sub. (4).

2. Where a horizontal branch connects to a drain stack within 2 feet above or below an offset with a change of direction of 30 to 45° from the vertical and the offset is located 5 or more branch intervals below the top of the stack, the offset shall be vented in accordance with s. Comm 82.31 (5) (a).

(b) *Offsets of more than 45°.* A drain stack with an offset of more than 45° from the vertical shall be installed in accordance with subds. 1. to 5.

1. That portion of the drain stack above the highest offset shall be sized as for vertical drain piping in accordance with sub. (4).

2. That portion of the offset between and including the offset fittings shall be sized as building drain piping in accordance with sub. (4).

3. That portion of stack below the offset shall be not less than the size of the offset.

4. Where an offset of more than 45° is located more than four branch intervals below the top of the drain stack, a horizontal branch may not connect within the offset or within 2 feet above or below such offset.

5. a. Except as exempted in subd. 5. b., where an offset in a drain stack with a change of more than 45° from vertical is located below 5 or more branch intervals, the offset shall be vented in accordance with s. Comm 82.31 (5) (b).

b. The vent required in subd. 5. a. shall not be required where the drain stack, including the offset, is sized one pipe size larger than required for a building drain designed to serve as per sub. (4) and the entire stack and offset are not less in cross sectional area than that required for a stack plus the area of a vent as required in s. Comm 82.31 (5) (b).

Note: See Appendix for further explanatory material.

(7) HORIZONTAL BRANCH DRAIN CONNECTION AT BASE OF A STACK. (a) A horizontal branch drain may not connect downstream from the base fitting of a drain stack 2" or larger in diameter within the distance equal to 10 pipe diameters of the drain to which the horizontal branch drain connects.

(b) A building drain branch or building subdrain branch may not connect to a building drain or building subdrain downstream from the base fitting of a drain stack 2" or larger in diameter within the distance equal to 20 pipe diameters of the building drain or building subdrain.

Note: See Appendix for further explanatory material.

(8) PIPING CHANGES IN DIRECTION. Changes in the direction of drain piping shall be accomplished in accordance with the requirements of this subsection.

(a) *Fittings.* All changes in direction of flow in drain piping shall be made by the appropriate use of 45 degree wyes, long or short sweep quarter bends, sixth, eighth, or sixteenth bends, or by a combination of these or other equivalent fittings. Except as provided in subds. 1. to 3., fittings which change the direction of flow for drain piping 8" or less in diameter shall conform to the minimum radii specified in Table 82.30-4.

Note: See Appendix for further explanatory material.

1. The minimum radius for the first 90° fitting downstream from a trap serving a lavatory or sink shall be 1-3/4" for drain piping 1-1/2" in diameter. The fitting shall be a tee or quarter bend.

2. The minimum radius for the first 90° bend or elbow downstream from a water closet shall be 2-1/2" for drain piping 3" in diameter.

3. The minimum radius for the first 90° bend or elbow downstream from a water closet shall be 3" for drain piping 4" in diameter.

Table 82.30-4
MINIMUM RADII OF FITTINGS (in inches)

Diameter of pipe (inches)	Changes in Direction of Flow	
	Horizontal to Vertical	Vertical to Horizontal and Horizontal to Horizontal
1-1/4	1-1/8	2-1/4
1-1/2	1-3/8	2-3/4
2	1-7/8	3-1/4
3	2-7/8	4-1/16
4	3-3/4	4-7/8
5	4-1/2	6-1/2
6	5	7
8	6	8

(b) *Blowout type fixtures.* Where blowout type fixtures are installed back to back, appropriate fittings shall be installed to prevent the passage of wastes from one fixture to the other.

(9) **DRAIN FITTINGS AND CONNECTIONS.** Drain fittings, connections, devices and methods of installation shall not obstruct or retard the flow of water, wastes, sewage or air in the drain system or venting system in an amount greater than the normal frictional resistance to flow, unless as otherwise permitted in this chapter or unless approved by the department.

(a) *Closest bend.* The reduction of a 4 x 3 inch closet bend or collar fitting from 4" to 3" shall not be considered an obstruction.

(b) *Side inlet tees or bends.* The side inlet of a low pattern or high pattern tee or bend shall not be used as a vent connection when the side inlet is placed in a horizontal position or when any arrangement of piping or fittings produces a similar effect.

(c) *Prohibited fittings and connections.* The types of fittings and connections specified in subds. 1. to 4. shall not be used for drain piping:

1. A heel inlet bend when the heel inlet is in the horizontal position;

2. A fitting or connection which has an enlargement chamber or recess with a ledge or shoulder, or reduction in pipe area in the direction of flow;

3. A fitting which has running threads; and

4. A connection by means of drilling and tapping of a drain or vent pipe, unless as otherwise approved by the department.

(d) *Saddles.* If a pipe saddle is used to connect drain piping together, the saddle shall be installed in accordance with s. Comm 84.30 (5) (d).

(10) **SUMPS, EJECTORS AND PUMPS.** (a) *Sumps.* 1. 'General.' All sanitary building subdrains shall discharge into an approved, vented sump with an airtight cover. The sump shall be so located as to receive the wastewater by gravity flow, and shall be located at least 25 feet from any water well or as otherwise approved by the department of natural resources.

2. 'Capacity.' Except as provided in pars. (c) and (d), the minimum capacity of the sump shall be determined in accordance with the provisions of subd. 2. a. to e.

a. The water supply fixture unit method shall be used to determine peak input flow in gallons per minute; only the fixtures that drain to the sump shall be included.

Note: When converting water fixture units to gallons per minute it is permissible to calculate the load as a supply system with predominantly flush tanks.

b. The capacity of the sump shall be such that the pump when actuated by the lowest "pump on" switch runs at least 20 seconds.

c. Between the highest "pump on" switch level and the sump inlet, the sump shall hold the amount of input that exceeds the discharge of the pumping equipment in a 5 minute peak input period,

but in no case shall the vertical distance between the switch and the inlet be less than 3".

d. The low water level shall be maintained in accordance with the pump manufacturer's requirements, but shall not be less than 4" above the sump bottom.

e. Sumps containing one pump shall have an inside diameter of at least 24". Sumps containing 2 pumps shall have an inside diameter of at least 30".

Note: See Appendix for further explanatory material.

3. 'Vents.' All sumps and all drains leading to a sump shall be vented in accordance with s. Comm 82.31.

4. 'Materials.' All sumps shall be constructed in a watertight manner of approved materials in accordance with ch. Comm 84.

5. 'Removable covers.' Penetrations through the top of removable sump covers shall be limited to those for the electrical supply, the vent piping and the discharge piping for the pump or pumps.

(b) *Ejectors and pumps.* 1. 'Where required.' The liquid from all sanitary building sumps shall be lifted and discharged into the building sanitary drain system by automatic ejectors, pumps or any other equally efficient method approved by the department.

2. 'Duplex equipment.' a. Duplex ejector or pumping equipment shall be installed in a public building where 3 or more water closets or more than 20 drainage fixture units discharge into a sump.

b. Duplex ejector or pumping equipment shall be installed where the sanitary wastes of 2 or more one- or 2-family dwellings discharge into a sump.

c. Where duplex ejector or pumping equipment is installed, appropriate devices shall be installed to automatically alternate operation of the pumps or ejectors and to operate both pumps or ejectors when one unit cannot handle the load.

d. Where duplex pumping equipment is installed, an audible or visual alarm system with a manual control reset shall be installed to indicate pump failure.

3. 'Size.' The size and design of an ejector or pump shall be determined by the capacity of the sump to be served, the discharge head and discharge frequency. All ejectors and pumps shall provide a minimum flow velocity of 2 feet per second in the forced discharge piping.

Note: See Appendix for velocity in relation to flow rate by various pipe sizes.

Note: Ejectors or pumps discharging to septic tanks may disturb the normal settling properties of the tank environment; contact the Safety and Buildings Division for more information.

a. All sewage grinder pumps shall have a minimum 1 1/4" diameter discharge opening and discharge piping.

b. All nongrinder-type sewage pumps serving water closets shall be capable of passing a 2" diameter solid ball and shall have a minimum 2" diameter discharge opening and discharge piping. All other pumps handling sanitary wastes shall be rated by the manufacturer as an effluent pump, shall be capable of passing a 1/2" diameter solid ball and shall have a minimum 1 1/4" diameter discharge opening and discharge piping.

4. 'Discharge connections.' a. The discharge pipe from the ejector or pump shall be connected to the gravity drain by means of a wye pattern fitting. Where the fitting connects to a horizontal drain, the bottom of the wye branch of the fitting shall be located above the horizontal center line.

b. With the exception of exterior sumps, a full flow check valve shall be installed in the discharge piping from each ejector or pump.

c. Where duplicate ejector or pumping equipment is installed, each discharge pipe from an ejector or pump shall be provided with a gate or ball type valve installed downstream of each full flow check valve.

5. 'Discharge pipe air relief.' Air relief valves shall be provided at all high points in the discharge piping of an ejector or pump where the piping arrangement creates an air trap.

6. 'Prohibited connections.' No fixtures may be connected to the discharge pipe between the ejector or pump and the point where it enters the gravity drain.

7. 'Maintenance.' All ejectors, pumps and like appliances shall receive care as needed to keep them in a satisfactory operating condition.

(c) *Prefabricated pumps and sump systems.* The minimum capacity of a prefabricated pump and sump system shall be determined in accordance with all of the following:

1. The water supply fixture unit, wsfu, method shall be used to determine peak input flow in gallons per minute. The peak input shall include all the fixtures that drain to the sump.

2. Unless storage is provided as specified in par. (a) 2., the capacity of the prefabricated pump and sump system shall accommodate the peak input flow.

3. The low water level shall be maintained in accordance with the pump manufacturer's requirements.

(d) *Exterior sumps.* The minimum capacity of exterior sumps shall be determined in accordance with all of the following:

1. Peak input flow in gallons per minute shall be determined in accordance with either of the following:

a. The water supply fixture unit, wsfu, method of all the fixtures that drain to the sump.

b. The provisions as specified in s. Comm 83.43 (2) through (6).

2. In lieu of providing the duplex pumping equipment as specified in par. (b) 2., a one-day holding capacity may be provided above a high level alarm when installed on a simplex system.

(11) **BUILDING DRAINS AND BUILDING SEWERS.** (a) *Limitations.* No building sewer may pass through or under a building to serve another building, unless:

1. The building sewer serves farm buildings or farm houses, or both, which are all located on one property; or

2. The building sewer or private interceptor main sewer serves buildings located on the same property and a document, which indicates the piping and distribution arrangement for the property and buildings, shall be recorded with the register of deeds no later than 90 days after installation.

(b) *Building drains.* 1. 'Elevation.' a. All building drains shall be installed below the lowest floor levels on which fixtures may be installed if the public sewer, POWTs or private interceptor main sewer elevation permits.

b. Where any portion of an above-ground building drain discharges to a vertical pipe, the building drain shall connect to the building sewer at an elevation at least 30" above the basement floor.

Note: See Appendix for further explanatory material.

2. 'Backwater protection.' A building drain subject to backflow or backwater shall be protected with a backwater valve or with a sump with pumping equipment in accordance with sub. (10).

a. Backwater valves, when fully open, shall have a capacity not less than that of the pipes in which installed.

b. Backwater valves shall be so located as to be readily accessible for cleaning.

3. 'Floor drain required.' a. Where a plumbing fixture or appliance is located on a floor which is entirely below grade, a floor drain shall be installed to serve that floor.

b. In any room containing the recessed or concealed portions of sterilizers located in health care or related facilities, at least one

floor drain connecting to the drainage system shall be installed in a manner to adequately drain the entire floor area.

(c) *Building sewers.* 1. 'Minimum depth.' a. The top of a building sewer shall be located at a depth of not less than 42" below finished grade, except as provided in subd. 1. b. or subd. 2.

b. The top of a building sewer which discharges to a septic tank, holding tank or grease interceptor shall be located at a depth of not less than 18" below finished grade.

2. 'Protection from frost.' a. Except as provided in subd. 2. c. to e., a building sewer or private interceptor main sewer shall be protected from frost in accordance with subd. 3. in areas where the top of the building sewer or private interceptor main sewer is located less than 60" below a surface area from which snow will be cleared.

b. Except as provided in subd. 2. c. to e., a building sewer or private interceptor main sewer shall be protected from frost in accordance with subd. 3. in areas where the top of the building sewer or private interceptor main sewer is located less than 42" below a surface area which snow will not be cleared.

c. Where a building sewer or private interceptor main sewer discharges to a holding tank, POWTs treatment tank or grease interceptor, the portion of a building sewer or private interceptor main sewer which is within 30 feet from the connecting building drain and which is under a surface area from which snow will not be cleared shall not be required to be protected from frost.

d. Frost protection for a building sewer shall not be required where the predicted depth of frost as determined from Figure 82.30-1 and Table 82.30-6 does not extend below the top of the building sewer.

e. Where a building sewer or private interceptor main sewer is installed to serve summer use public facilities, frost protection requirements shall not apply.

Note: This exemption applies to frost sleeves as provided in s. Comm 82.35 (5) (a) 2.

3. 'Insulation for building sewers.' Where required by subd. 2. a. or b., building sewer or private interceptor main sewer insulation for frost protection shall be provided in accordance with one of the methods specified in subd. 3. a. to d.

a. Extruded polystyrene foam insulation shall be installed at a depth of at least 18" below finished grade and at least 6" above the top of the sewer pipe. The minimum thickness and width of the foam insulation shall be determined from Figure 82.30-1 and Tables 82.30-5 to 82.30-7. If the insulation is to be installed more than 6" above the top of the sewer, the number of inches exceeding 6" shall be added to the width of insulation determined from Table 82.30-7.

b. Extruded polystyrene foam insulation shall be installed using a box method. The 3-sided box shall be formed with 3 lengths of polystyrene foam insulation where the top of the box extends horizontally to the farthest edge of both vertical sides. The insulation shall be installed at or below a depth of at least 12" below finished grade and 6" above the top and 6" from each side of the building sewer or private interceptor main sewer. The minimum thickness of the foam insulation shall be determined from Figure 82.30-1 and Table 82.30-5.

Note: See Appendix for further explanatory material.

c. Lightweight insulating concrete shall be installed to the depth of the spring line of the sewer and shall extend laterally at least 6" on both sides of the sewer. The minimum thickness of the insulating concrete shall be determined from Figure 82.30-1 and Table 82.30-5. The thickness shall be measured from the top of the sewer. The top of the insulation shall be installed at least 12" below finished grade.

d. Alternative methods of frost protection shall be approved by the department.

Figure 82.30-1. Frost protection zones.

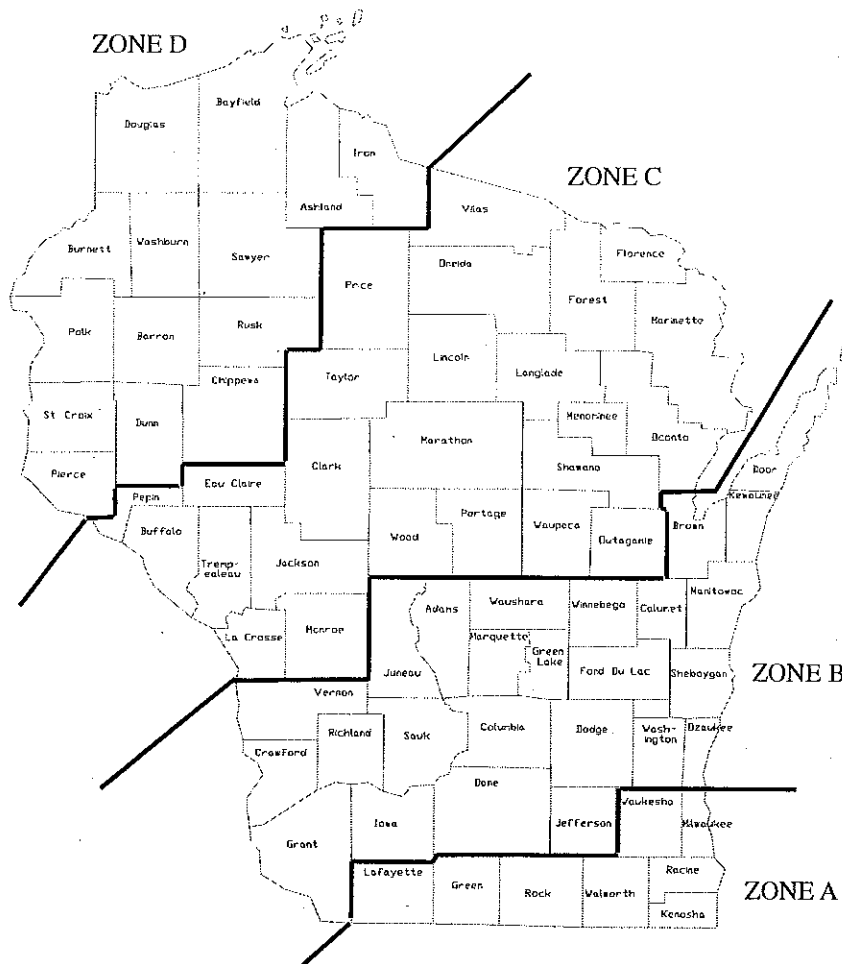

Table 82.30-5
MINIMUM THICKNESS OF INSULATION

Frost Protection Zone	Extruded Polystyrene Foam (in inches)	Insulating Concrete (in inches)
A	1.0	6
B	1.5	9
C	2.0	12
D	2.5	15

Table 82.30-6
PREDICTED DEPTH OF FROST IN VARIOUS TYPES OF BACKFILL SOIL (in feet)

Soil Type	Frost Protection Zone			
	A	B	C	D
Clay, Clay Loam	2.5	3.0	3.5	4.0
Silt Loam, Silty Clay Loam	3.5	4.0	4.5	5.5
Sandy Clay Loam	4.0	4.5	5.5	6.0
Sandy Loam, Loamy Sand	4.5	5.0	6.0	6.5
Sand	5.0	5.5	6.5	7.5
Gravelly Sand	6.0	7.5	9.0	10.0

Table 82.30-7
MINIMUM WIDTH OF EXTRUDED POLYSTYRENE FOAM INSULATION (in feet)

Predicted Depth of Frost (feet)	Depth of Sewer (in feet)					
	2.0	2.5	3.0	3.5	4.0	4.5
2.5	2	NR				
3.0	3	2	NR			
3.5	4	3	2	NR		
4.0	5	4	3	2	NR	
4.5	6	5	4	3	2	NR
5.0	7	6	5	4	3	2
5.5	8	7	6	5	4	3
6.0	9	8	7	6	5	4
6.5	10	9	8	7	6	5
7.0	10	10	9	8	7	6
7.5	10	10	10	9	8	7
8.0	10	10	10	10	9	8
8.5	10	10	10	10	10	9
9.0	10	10	10	10	10	10
10.0	10	10	10	10	10	10

NR means Not Required.

(d) *Location limitations.* Building drains, building sewers or private interceptor main sewers shall be separated from water wells by the applicable separation distances contained in chs. NR 811 and 812 or as otherwise approved by the department of natural resources.

Note: See s. Comm 82.40 for provisions regarding the separation of water supply piping, building sewers and private interceptor main sewers.

Note: See Appendix for further explanatory material. Section NR 812.08 may require additional setbacks.

(e) *Installation of building drains and building sewers.* 1. 'Trenching.' All excavations for building drains and building sewers shall be open trench work, unless otherwise permitted by local ordinance or accepted by the local inspector.

2. 'Stable bottom.' Where the bottom of the trench can be maintained in a stable condition and free of water during the time of installation the building drain and the building sewer shall be bedded and initially backfilled to comply with all the following requirements:

a. Where the trench bottom does not contain stone larger than one inch in size or where bedrock is not encountered, the trench may be excavated to grade.

b. Where stone larger than one inch size or when bedrock is encountered, the trench shall be excavated to a depth at least 3 inches below the grade elevation and shall be brought back to grade with a bedding of sand, gravel or crushed stone that shall be of a size that all the material shall pass a ¾-inch sieve.

c. Bedding shall be sufficiently dry and hand or mechanically compacted to a minimum of 90 percent standard proctor density.

d. Initial backfill to a depth of 12 inches over the pipe shall be sand, crushed stone or excavated material which is neither corrosive nor organic in nature.

e. Initial backfill shall be of a size that passes a one-inch sieve.

f. A concrete floor may be placed over a building drain having less than 12 inches of initial backfill.

g. Initial backfill shall be placed in increments not to exceed 6 inches in depth.

h. Initial backfill shall be well tamped for the full width of the trench and length of the sewer.

3. 'Unstable bottom.' Where a mucky or unstable bottom is encountered in the trench, the required dry and stable foundation

conditions shall be provided by providing one of the following options:

a. Sheathing shall be driven and left in place to a depth of 48 inches below the trench bottom or to solid foundation to a lesser depth.

b. Removal of wet and yielding material to a depth of 24 inches or to solid material and replacement of the unstable material with limestone screenings, pea gravel or equivalent material.

c. Install a longitudinally reinforced concrete cradle the width of the trench and at least 3 inches thick.

d. Install a longitudinally reinforced concrete slab the width of the trench and at least 3 inches thick.

e. Backfill and bedding shall comply with subd. 2. d. to h.

4. 'Backfill completion.' Care shall be exercised in placing the balance of the backfill to prevent breakage of the pipe. Large boulders or rock, concrete slabs, or frozen masses shall not be used in the backfill. At least 36" of backfill cover shall be provided over the top of the pipe before the pipe trench is wheel-loaded.

5. 'Pipe openings protected.' The ends of all pipes not immediately connected shall be closed so as to prevent the introduction of earth or drainage from an excavation.

(f) *Connection to public sewer.* The connections of building sewers to public sewers shall be in accordance with conditions of approval for the public sewer granted by the department of natural resources under s. 281.41, Stats.

1. 'Gravity public sewer.' When a building sewer connection to the public sewer is not found within 3 feet of the point designated by the local governing body or its authorized representative, the connection shall be made in accordance with one of the provisions specified in subd. 1. a. to d.

a. A saddle fitting approved by the department and acceptable to the municipality or sanitary district shall be installed.

b. Where acceptable to the municipality or sanitary district a portion of the main sewer may be removed and a tee or wye fitting approved by the department may be inserted with compression joints in the public sewer acceptable to the municipality or the sanitary district. The insertion shall be made under the supervision of the authorized representative of the municipality or the sanitary district.

c. When the public sewer is concrete or clay, the end of the connecting sewer may be set upon or in an opening cut into the top half of the public sewer, but shall not protrude into the public sewer. The connection shall be secured by encasing the main sewer pipe and the connection in concrete at least 3" thick so as to assure permanency of the connection and adequate backing of the public sewer pipe.

d. In lieu of the use of a fitting and in the event that an opening cannot be located in the top half of the public sewer, a length of concrete or clay public sewer pipe may be removed and a section with a wye fitting shall be inserted in its place. The joints at the ends of the section shall be encased in concrete at least 3" thick. The connection or insertion shall be made under the supervision of the authorized representative of the municipality or the sanitary district.

2. 'Pressurized public sewer.' Where a forced building sewer discharges to a pressurized public sewer all of the following requirements shall apply:

a. A curb stop shall be installed on the same property as close as possible to the connection to the common forced main sewer.

b. A check valve shall be installed in the pressurized building drain or building sewer.

c. An accessible quick disconnect shall be installed upstream of the check valve.

Note: See Appendix for further explanatory material.

(g) *Prohibited installations.* 1. 'Harmful discharge.' No person may connect to a public sewer any building drain or building sewer through which is discharged any substance likely to cause undue corrosion, obstruction, nuisance, explosion or interference with sewage treatment processes.

2. 'Storm water and clear water connections.' Except as provided in s. Comm 82.36 (3), storm drain piping and clear water drain piping may not discharge to a sanitary building drain which connects to a publicly-owned treatment works.

Note: See s. Comm 82.36 for provisions relative to storm sewers.

(h) *Locating requirements.* A means to locate buried non-metallic sewers and private interceptor main sewers discharging to municipal mains shall be accomplished in accordance with one of the following options:

Note: See the appendix for further information.

1. A tracer wire shall be installed in accordance with all of the following:

a. Tracer wire shall be installed along the length of the non-metallic pipe.

b. Tracer wire shall be a minimum of 18 gauge, insulated, single-conductor copper wire or equivalent.

c. Tracer wire shall be located directly above and within 6 inches of the non-metallic pipe.

d. Tracer wire shall be accessible and locatable within the owner's property at 400-foot intervals or increments thereof.

e. Exterior access locations shall include a means of protecting the tracer wire.

f. In-ground sleeves shall be installed as provided in s. Comm 82.35 (5) (a) 2. c. and d.

g. Where tracer wire is more than 6 inches from the pipe, tracer wire insulation color shall comply with subd. 1. h.

h. Tracer wire insulation color for non-metallic sewer pipe shall be green.

i. Tracer wire conductivity shall be tested prior to use.

j. Conductive warning tape may not be utilized in lieu of tracer wire.

2. Global positioning system data shall be recorded with the municipality where the non-metallic pipe is installed.

3. Another equally-effective means acceptable to the department shall be employed to mark the location of the non-metallic pipe.

(12) PRIVATE INTERCEPTOR MAIN SEWERS. (a) The connection of a private interceptor main sewer to a public sewer shall be in accordance with the conditions of approval for the public sewer granted by the department of natural resources under s. 281.41, Stats.

(b) Private interceptor main sewers which discharge to a municipal treatment facility shall be designed in accordance with the appropriate water quality management plan.

(c) All private interceptor main sewers shall be tested in accordance with s. Comm 82.21.

(d) Private interceptor main sewers 6" or less in diameter shall be installed in accordance with the criteria for building sewers specified in sub. (11) (b) and (c) and (d) and (e).

(e) Private interceptor main sewers 8" or larger in diameter shall be:

1. Provided with frost protection in accordance with sub. (11) (c); and

2. Installed in accordance with the municipal sewer criteria specified in s. NR 110.13.

(f) No private interceptor main sewer may pass through or under a building to serve another building, unless one of the following conditions are met:

1. The private interceptor main sewer serves farm buildings, farm houses, or both which are located on one property.

2. The private interceptor main sewer serves buildings that are located on one property and a document, which indicates the piping and distribution arrangement for the property and buildings, shall be recorded with the register of deeds no later than 90 days after installation.

(13) LOCATION OF DRAIN PIPING. (a) Drain piping located below the ceilings of areas where food, ice or potable liquids are prepared, handled, stored or displayed shall be installed with the least number of joints and shall be installed in accordance with subs. 1. to 5.

1. All pipe openings through floors shall be provided with sleeves bonded to the floor construction and protruding not less than one inch above the top of the finish floor with the space between sleeve and the piping sealed.

2. Plumbing fixtures, except bathtubs and showers, shall be of the wall mounted type. Bathtubs shall have waste and overflow connections made above the floor and piped to a trap below the floor.

3. Floor and shower drains installed shall be equipped with integral seepage pans.

4. Cleanouts for piping shall be extended through the floor construction above.

5. Piping subject to operation at temperatures that will form condensation on the exterior of the pipe shall be thermally insulated.

(b) Where drain piping is located in ceilings of areas where food, ice or potable liquids are prepared, handled stored or displayed, the ceilings shall be of the removable type, or shall be provided with access panels in order to provide an access for inspection of the piping.

(c) Exposed drain piping shall not be located over a pool, surge tank or an open filter for a pool.

History: Cr. Register, February, 1985, No. 350, eff. 3-1-85; am. Table 82.30-1, (8) (a), (9) (c) (intro.) and 3., and (10) (b) 3. b., r. and recr. (4) (d) 2., Table 82.30-4, (10) (a) 2. b., (11) (intro.) and (f) 2., cr. (8) (a) 1. to 3. and (9) (d), r. (9) (c) 4., renum. (9) (c) 5. to be 4. and am., Register, May, 1988, No. 389, eff. 6-1-88; r. and recr. (4) (d), am. Table 82.30-3 and 82.30-7, r. (11) (intro.), renum. (11) (a) to (f) to be (b) to (g), cr. (11) (a) and (12) (f), Register, August, 1991, No. 428, eff. 9-1-91; am. Table 82.30-1, Register, April, 1992, No. 436, eff. 5-1-92; am. (7) (a) and (b), (11) (c) 1. a., (12) (e) 1. and Table 82.30-1, cr. (10) (a) 5., r. (11) (b) 1. b., renum. (11) (b) 1. c. to be (11) (b) 1. b., Register, February, 1994, No. 458, eff. 3-1-94; reprinted to restore dropped copy in (10) (b) 3. b., Register, July, 1994, No. 463; corrections in (11) (f) and (12) (g) made under s. 13.93 (2m) (b) 7., Stats., Register, April, 1998, No. 508; am. (11) (g) 2., Register, April, 2000, No. 532, eff. 7-1-00; CR 02-002: am. (4) (d) 5., (5) (b) 2. b., (c) 2., (10) (a) 2., (b) 4. b., (11) (b) 1. a., (c) 2. a. to c., 3. (intro.), (g) 2., (12) (f) (intro.) and 1., and Tables 82.30-1, 2. 3, 5 and 6, cr. (10) (b) 2. d., (c), (d), (11) (b) 3. b. and (c) 2. e., r. and recr. (11) (a) 2., (d), and (12) (f) 2., renum. (11) (b) 3., (c) 3. b. and c. to be (11) (b) 3. a., (c) 3. c. and d., Register April 2003 No. 568.

eff. 5-1-03; CR 04-035: r. (3) (b) 32. a., am. Table 82.30-1 Register November 2004 No. 587, eff. 12-1-04; CR 07-069: cr. (11) (h) Register February 2008 No. 626, eff. 3-1-08; CR 08-055: am. (3), (6) (a) 2., (b) 1. to 3., (10) (a) 1., Tables 82.30-1 and 82.30-3, r. (4) (b), renum. (4) (c) to (e) and (11) (h) 1. g. to i. to be (4) (b) to (d), and (11) (h) 1. h. to j., r. and recr. (6) (b) 4., 5., (11) (e) 2., 3., (f) 2. and Table 82.30-2, cr. (11) (h) 1. g. Register February 2009 No. 638, eff. 3-1-09; correction in (6) (a) made under s. 13.92 (4) (b) 1., Stats., Register February 2009 No. 638.

Comm 82.31 Vents and venting systems. (1) SCOPE.

The provisions of this section set forth the requirements for the design and the installation of vents and venting systems.

(2) MATERIALS. All vents and venting systems shall be constructed of approved materials in accordance with ch. Comm 84.

(3) GENERAL. (a) *Vents.* Every trap and trapped plumbing fixture shall be provided with an individual vent, except as otherwise permitted in this chapter. Vents and venting systems shall be designed and installed so that the water seal of a trap shall be subject to a maximum pneumatic pressure differential equal to one inch of water column.

(b) *Main stack.* Each gravity-flow sanitary building sewer shall be served by at least one stack which extends from a building drain to a vent terminal or vent header. The stack shall be not less than 3" in diameter from the building drain to the vent terminal or vent header.

(4) VENT STACKS AND STACK VENTS. (a) *Where required.* A vent stack and a stack vent shall be installed to serve any drain stacks of 5 or more branch intervals.

(b) *Installation.* 1. The connection of the vent stack to a drain stack shall be at or below the lowest branch drain connection to the drain stack. The connection to the drain stack shall be by means of a wye pattern fitting installed in a vertical portion of the stack.

2. A vent stack and a stack vent shall:

- a. Extend to a vent terminal in accordance with sub. (16);
- b. Connect to a vent stack which extends to a vent terminal;

or

c. Connect to a stack vent at least 6" above the flood level rim of the highest fixture discharging into a drain stack.

3. Vent stacks and stack vents may connect into a common vent header and then shall extend to a vent terminal.

4. The connection of a vent stack with another vent may not be less than 38" above the next higher floor level where the plumbing fixtures are vented, but in no case lower than 2" above the elevation of the highest flood level rim of any fixture served by the vent.

Note: See Appendix for further explanatory material.

(5) RELIEF AND YOKE VENTS FOR STACK OFFSETS. (a) *Vents serving offsets of 30 to 45° in drain stacks.* 1. Except as permitted in subd. 2., where a horizontal branch connects to a drain stack within 2 feet above or below an offset with a change of direction of 30 to 45° from the vertical and the offset is located below 5 or more branch intervals, the offset shall be vented in accordance with par. (b) 1. to 3.

2. Where the drain stack and offset are sized as building drain as per Table 82.30-3, the vent serving the offset of 30 to 45° in a drain stack is not required.

(b) *Vents serving offsets of more than 45° in drain stacks.* Offsets of more than 45° in drain stacks shall be vented where 5 or more branch intervals are located above the offset. The offset shall be vented by venting the upper and lower section of the stack.

1. 'Upper section.' The upper section of the stack shall be vented as a separate stack with a vent stack connection installed in accordance with sub. (4). The offset shall be considered the base of the stack.

2. 'Vent connection above offset.' The vent stack shall connect with a wye pattern fitting above the stack offset and at or below the lowest drain branch above the offset.

3. 'Lower section.' The lower section of the stack shall be vented by a yoke vent connecting below the offset above or at the next lower horizontal branch.

a. Except as provided in subd. 3. b., the connection of the yoke vent to the drain stack shall be by means of a wye pattern fitting.

b. The yoke vent connection may be a vertical extension of the stack.

c. The connection of the yoke vent to another vent shall not be less than 38 inches above the next higher floor level where plumbing fixtures are installed that discharge into the drain stack.

(6) RELIEF VENTS FOR STACKS OF MORE THAN 10 BRANCH INTERVALS. (a) Drain stacks of more than 10 branch intervals shall be provided with a relief vent at each tenth interval installed.

(b) The lower end of the relief vent required in par. (a) shall connect to the stack by use of a wye pattern fitting below the horizontal branch serving that floor.

(c) The upper end of the relief vent required in par. (a) shall connect to the vent stack by means of a wye pattern fitting not less than 3 feet above the floor level with the highest fixtures.

(7) RELIEF VENTS FOR BUILDING DRAINS. A building drain with a change in elevation of 12 feet or more and at an angle of 45° or more from the horizontal shall be provided with a relief vent.

(a) The connection of the relief vent to the building drain shall be by means of a wye pattern fitting installed within 2 feet upstream of the top of the change in elevation.

(b) The connection of the relief vent to another vent shall be not less than 38" above the next higher floor level where plumbing fixtures are installed that discharge through the building drain.

Note: See Appendix for further explanatory material.

(8) VENTS FOR SANITARY SUMPS. (a) *Interior sanitary sumps.* Sanitary sumps shall be provided with a vent connecting either to the sump above the drain inlet or to the drain inlet within 12" of the sump.

(b) *Exterior sanitary sumps.* Sanitary sumps shall be provided with a vent that terminates in accordance with sub. (16) (h).

(9) FIXTURE VENTS. (a) *Developed length between vent and trap.* Each fixture trap shall be protected with a vent located in accordance with the provisions of subds. 1. and 2.

1. Each fixture trap which is not an integral part of the fixture shall be protected with a vent so located that the developed length of the fixture drain piping from the trap weir to the vent connection is within the limits set forth in Table 82.31-1.

2. Each fixture trap which is an integral part of the fixture shall be protected with a vent so located that the developed length of the fixture drain piping from fixture outlet to the vent connection is within the limits set forth in Table 82.31-1. For a floor outlet water closet or similar fixture, the point where the fixture drain piping turns horizontal shall be considered as the fixture outlet.

(b) *Minimum distance.* A vent shall not connect to a fixture drain within the distance equal to 2 diameters of the drain piping from the weir of a trap.

Note: See Appendix for further explanatory material.

Table 82.31-1
MAXIMUM DEVELOPED LENGTH BETWEEN VENT AND TRAP (in feet)

Diameter of Fixture Drain ^a (inches)	Vent Connecting to Horizontal Drain Piping			Vent Connecting to Vertical Drain Piping					
	Pitch of Fixture Drain (inch per foot)			by means of a Sanitary Tee Fitting			by means of a Wye Pattern Fitting ^b		
				Pitch of Fixture Drain (inch per foot)			Pitch of Fixture Drain (inch per foot)		
	1/8	1/4	1/2	1/8	1/4	1/2	1/8	1/4	1/2
1 1/4	NP ^c	5.0	2.5	NP	3.5	2.0	NP	1.5	1.0
1 1/2	NP	6.0	3.0	NP	5.0	3.0	NP	4.0	2.0
2	NP	8.0	4.0	NP	6.0	4.0	NP	4.5	4.0
3	24	12.0	6.0	10.0	8.0	6.0	8.0	6.0	6.0
4 ^d	32	16.0	8.0	12.0	10.0	8.0	10.0	8.0	8.0

^a Diameters to be selected on the basis of the smallest drain pipe installed downstream from the trap serving a particular fixture.

^b The wye pattern fitting refers to a tee-wye fitting, a combination wye and eighth bend fitting or a wye and eighth bend combination of fittings with no more than one inch between the wye fitting and eighth bend fitting.

^c NP means Not Permitted.

^d The maximum developed length for fixture drains larger than 4 inches in diameter shall be approved by the department.

(10) CIRCUIT VENTING. In lieu of providing individual vents, a horizontal drain to which at least 2 but not more than 8 wall outlet fixtures or at least 2 but not more than 8 floor outlet fixtures, other than blowout type fixtures and wall-outlet carrier type water closets, are connected to the same horizontal branch drain, may be vented by a circuit vent in accordance with pars. (a) to (e).

(a) The circuit vent shall connect to the horizontal drain at a point between the 2 most upstream fixtures.

(b) 1. A circuit vented horizontal drain into which 4 or more fixtures discharge shall be provided with a relief vent. The relief vent shall connect to the circuit vented horizontal drain downstream of the most downstream fixture drain which is vented by the circuit vent and upstream of any other drain connections.

2. Two circuit vented horizontal drains serving a total of 8 fixtures, 4 on each branch, shall be provided with at least one relief vent, unless the horizontal drains connect to a drain stack with no other drain connections located above the circuit vented horizontal drains. One relief vent may serve both horizontal drains, if installed downstream of the point where the 2 horizontal drains are joined.

Note: See Appendix for further explanatory material.

(c) A horizontal drain served by a circuit vent may not diminish in size from the most downstream fixture drain connection vented by the circuit vented drain to the circuit vent connection. Where a relief vent is installed, the horizontal drain served by the circuit vent shall not diminish in size from the relief vent connection to the circuit vent connection.

(d) Fixture drains served by a circuit vent shall conform to the provisions of sub. (9). The connection of the fixture drain to the branch drain served by the circuit vent shall be considered as the vent connection.

(e) Additional wall outlet fixtures with a drainage fixture unit value of one or less which are served by individual vents or common vents may discharge into a horizontal drain served by a circuit vent.

(11) COMMON VENTS. In lieu of providing individual vents, fixtures may be common vented in accordance with pars. (a) and (b).

(a) *Vertical drains.* A common vent may serve a maximum of 2 fixtures where both fixture drains connect to a vertical drain at the same elevation. Where this connection is by means of a sanitary tee fitting with a side inlet, the centerline of the side inlet opening may not be below the centerline of the larger opening. The drain connection of a blowout type fixture or a kitchen sink served by a common vent may not be by means of a double sanitary tee fitting.

(b) *Horizontal branches.* The fixture drains from 2 wall-outlet fixtures, each with a drainage fixture unit value of one or less, or the fixture drains from 2 traps serving a kitchen sink with or without a dishwasher may connect to a horizontal branch without individual vents provided a common vent connects to the branch drain downstream of both fixture drains. Both fixture drains shall be of the same diameter. The developed length of the drain from the vent to the farthest trap shall conform to sub. (9).

Note: See Appendix for further explanatory material.

(12) RETURN VENTS. Plumbing fixtures may be vented in accordance with pars. (a) to (d).

(a) Wall outlet fixtures may be vented by extending an individual vent, vertical wet vent or a common vent as high as possible under the fixture enclosure and returning the vent vertically downward and connecting the vent to the fixture drain or branch drain by means of a wye pattern fitting.

(b) Horizontal vent piping shall connect to the vertical section of the fixture vent and extend to a point where it can extend vertically to a vent terminal in accordance with sub. (16) or connect to another vent in accordance with sub. (15).

(c) Drainage fittings shall be used on all sections of the vent pipe below the floor level and a minimum slope of 1/4" per foot to the drainage point shall be provided.

(d) Cleanouts shall be provided on the vent piping in accordance with s. Comm 82.35.

Note: See Appendix for further explanatory material.

(13) WET VENTING. In lieu of providing individual vents, fixtures may be wet vented in accordance with pars. (a) to (c).

(a) *Vertical wet vents.* 1. Where 2 wall outlet fixtures are located on the same floor level with their fixture drains connecting to the same vertical drain pipe at different elevations, the lower fixture drain may be wet vented in accordance with subd. 1. a. to e.

a. No other fixtures may discharge into the vertical drain pipe above or between the 2 wall outlet fixtures. Additional fixtures may discharge into the vertical drain pipe below the 2 wall outlet fixtures.

b. A branch vent shall connect to the vertical drain pipe immediately above the higher fixture drain connection.

c. The drain between the 2 fixtures shall be at least one pipe size larger than the upper fixture drain, but not smaller than 2" in diameter.

d. Both fixture drains shall conform to sub. (9). The connection of the lower fixture drain to the vertical drain shall be considered as the vent connection.

e. The higher fixture drain may not serve a water closet.

Note: See Appendix for further explanatory material.

(b) *Horizontal wet vents.* A drain from a lavatory or lavatories which are either provided with individual vents or a common vent may serve as the wet vent for not more than 2 bathtubs or showers and not more than 2 water closets in accordance with subds. 1. to 7. No other fixtures may discharge into or be served by the wet vent.

1. All of the fixtures shall be located in nonpublic bathroom groups.

2. The lavatories and bathtubs or showers shall have a common horizontal drain with the drain for the lavatories serving as a wet vent for the bathtubs or showers.

3. Where 2 bathtubs or showers are served by the same wet vent, their fixture drains shall connect independently to the common horizontal drain downstream of the vertical drain serving the lavatory or lavatories.

4. Where 2 bathtubs or showers and 2 water closets are served by the same wet vent a relief vent shall be provided, unless the wet vented horizontal drain connects to a drain stack with no other drain connections located above the wet-vented horizontal drain. The relief vent shall connect to the horizontal drain at a point downstream of the fixture drains for the water closets and upstream of any other fixture drain connections.

5. One or 2 water closets may connect to the common horizontal drain with the drain from the lavatories and bathtubs or showers also serving as a wet vent for the water closets. Where 2 water closets are served by the same wet vent, their fixture drains shall connect independently to the common horizontal drain at the same point.

6. The wet vent shall be at least 2" in diameter. No more than 4 drainage fixture units may discharge into a 2" diameter wet vent.

7. A branch vent shall connect immediately above the highest fixture drain connection and shall be sized in accordance with sub. (14).

(c) *Other types of wet vents.* An individual vent serving a floor outlet fixture, a common vent serving floor outlet fixtures, a circuit vent, a relief vent serving a circuit vented drain or a relief vent serving a wet vented horizontal drain may serve as a wet vent in accordance with subds. 1. to 4.

1. No more than 2 wall outlet fixtures, each fixture with a drainage fixture unit value of one or less, may have their fixture drains connected into the individual vent, common vent, circuit vent or relief vent.

2. The wet vent shall be at least 2" in diameter.
3. The branch vent to which the wet vent connects shall be sized in accordance with sub. (14). The branch vent may serve the wall outlet fixtures in lieu of individual vents or a common vent.

4. The fixtures discharging into the wet vent shall be located on the same floor level as the fixtures served by the wet vent.

Note: For explanatory material refer to Appendix A-82.31 (13).

(14) VENT SIZE. (a) *Stack vents and vent stacks.* Stack vent and vent stack pipe sizes shall be determined in accordance with Table 82.31-2 on the basis of developed length and the diameter of the drain stack at its base.

1. The developed length of the stack vent shall be measured along the vent pipe, from the highest drain branch connection to the vent terminal or to the connection to a vent header.

2. The developed length of the vent stack shall be measured along the vent pipe from the vent stack base connection to the vent terminal or to the connection to a vent header.

Note: See Appendix for further explanatory material.

(b) *Vent headers.* 1. Vent header pipe sizes shall be determined in accordance with Table 82.31-3 with the number of drainage fixture units being the sum of the fixture unit loads of the stacks vented through that portion of the header. The diameter of a vent header shall not be less than any vent connecting to it.

2. The developed length of the vent header shall be measured along the pipe from the most distant vent stack or stack vent base connection to the vent terminal.

Note: See Appendix for further explanatory material.

(c) *Branch vents.* Branch vent pipe sizes shall be determined in accordance with Table 82.31-3. The developed length of the branch vent shall be measured along the pipe from the furthest fixture drain served by the branch vent to the point where it connects to a vent pipe of a larger diameter or to a vent terminal.

Note: See Appendix for further explanatory material.

(d) *Individual vents.* Individual vent pipe sizes shall be determined in accordance with Table 82.31-3. The developed length of an individual vent shall be measured along the vent pipe from the fixture drain served by the vent to the point where it connects to a vent pipe of a larger diameter or to a vent terminal.

Note: See Appendix for further explanatory material.

(e) *Common vents.* Common vent pipe sizes shall be determined in accordance with Table 82.31-3. The developed length of a common vent shall be measured along the vent pipe from the drain served by the vent to the point where it connects to a vent pipe of a larger diameter or to the vent terminal.

Table 82.31-2
SIZE AND LENGTH OF VENT STACKS AND STACK VENTS

Diameter of Drain Stack at Base (inches)	Maximum Developed Length of Vent (feet)									
	Diameter of Vent (inches)									
	1 1/4	1 1/2 ^a	2	3	4	5	6	8	10	12
1 1/2	50	150	NL ^b							
2	NP ^c	50	150	NL						
3		NP	50	400	NL					
4		NP	20	180	700	NL				
5			NP	50	200	700	NL			
6			NP	20	70	200	700	NL		
8				NP	25	60	250	800	NL	
10					NP	25	60	250	800	NL
12						NP	25	100	300	900

^a Not more than 2 water closets or similar flush action type fixtures of 4 or more drainage fixture units.

^b NL means No Limit.

^c NP means Not Permitted.

Table 82.31-3
MINIMUM DIAMETERS AND MAXIMUM LENGTH OF INDIVIDUAL, COMMON,
BRANCH AND CIRCUIT VENTS AND VENT HEADERS

Drainage Fixture Units (dfu)	Maximum Developed Length of Vent (feet)								
	Diameter of Vent (inches)								
	1 ¹ / ₄ ^a	1 ¹ / ₂ ^b	2	3	4	5	6	8	10
2	50	NL ^c							
4	40	200	NL						
8	NP ^d	150	250	NL					
10	NP	100	200	NL					
24	NP	50	150	NL					
42	NP	30	100	500	NL				
72		NP	50	400	NL				
240		NP	40	250	NL				
500		NP	20	180	700	NL			
1100			NP	50	200	700	NL		
1900			NP	20	70	200	700	NL	
3600				NP	25	60	250	800	NL
5600					NP	25	60	250	800

^a No water closets permitted.

^b Not more than 2 water closets or similar flush action type fixtures of 4 or more drainage fixture units.

^c NL means No Limit.

^d NP means Not Permitted.

(f) *Circuit vents.* Circuit vent pipe sizes shall be determined in accordance with Table 82.31-3. The developed length of the circuit vent shall be measured along the vent from the connection with the branch drain served by the vent to the point where it connects to a vent pipe of a larger diameter or to a vent terminal.

(g) *Relief vents.* Relief vents shall be sized in accordance with the provisions of subds. 1. to 4. The developed length of a relief vent shall be measured along the vent from the connection with the branch drain served by the vent to the point where it connects to a vent pipe of a larger diameter or to a vent terminal.

1. 'Circuit vented branch drain.' The diameter of a relief vent for a branch drain served by a circuit vent shall be at least one half the diameter of the branch drain. The maximum developed length shall be determined from Table 82.31-3 based on the number of drainage fixture units served by the vent.

2. 'Drain stacks.' A vent serving an offset in a drain stack shall be sized as a stack vent in accordance with par. (a).

3. 'Building drain.' The diameter of a relief vent serving a building drain, as required in sub. (7), shall be at least one half the diameter of the building drain. The maximum developed length shall be determined from Table 82.31-3 based on the number of drainage fixture units served by the vent.

4. 'Horizontal wet vent.' The diameter of a relief vent serving a horizontal wet vent shall be at least 1¹/₂". The maximum developed length shall be determined from Table 82.31-3 based on the number of drainage fixture units served by the vent.

(h) *Yoke vents.* A yoke vent serving a drain stack shall be sized as a vent stack in accordance with par. (a).

(i) *Vents for sumps.* 1. a. Except as provided in subd. 1. b., the size of a vent for a sanitary pump with other than a pneumatic ejector, shall be determined in accordance with Table 82.31-4.

b. The size of a vent for a sanitary sump located outside with other than a pneumatic ejector shall be determined in accordance with Table 82.31-4, but shall not be less than 2" in diameter.

2. The air pressure relief pipe from a pneumatic ejector shall not be connected to vent or vent system serving a sanitary drain system, storm drain system or chemical waste system.

a. The relief pipe shall be of a size to relieve the air pressure inside the ejector to atmospheric pressure, but shall not be less

than 2" in diameter where the ejector is located outside and 1¹/₄" in diameter for all other ejector locations.

b. The vent shall terminate in accordance with the provisions of sub. (16).

Table 82.31-4
SIZE AND LENGTH OF VENTS FOR
SANITARY SUMPS

Discharge Capacity of Ejector (gpm)	Maximum Developed Length of Vent ^a (feet)				
	Diameter of Vent (inches)				
	1 ¹ / ₄ ^d	1 ¹ / ₂ ^d	2	3	4
10	NL ^b				
20	270	NL			
40	72	160	NL		
60	31	75	270	NL	
80	16	41	150	NL	
100	10	25	97	NL	
150	NP ^c	10	44	370	NL
200		NP	20	210	NL
250		NP	10	132	NL
300		NP	10	88	380
400			NP	44	210
500			NP	24	130

^a The developed length of the vent is measured along the pipe from the connection to the sump, to the point where it connects to a vent pipe of a larger diameter.

^b NL means No Limit.

^c NP means Not Permitted.

^d Diameter not permitted for exterior sumps.

(j) *Vents for chemical basins.* The size of vents serving chemical dilution or neutralizing basins shall be determined in accordance with Table 82.31-3 and based upon the number of drainage fixture units discharging into the basins.

(15) VENT GRADES AND CONNECTIONS. (a) *Vent grade.* All vent and branch vent pipes shall be graded and connected so as to drain back to a drain pipe by means of gravity.

(b) *Installation.* Vents shall be installed in accordance with subs. 1. to 3.

1. Except for wet vent piping, the connection of a vent to horizontal drain piping shall be at a point above the horizontal center line of the drain piping.

2. Except as provided in subs. (12) and (17), vent piping serving a wall-outlet fixture may not offset horizontally less than 36" above the floor, but in no case lower than the elevation of the highest flood level rim of any fixture served by the vent.

3. Vent piping may not connect to a branch vent less than 38" above the floor, but in no case lower than 2" above the elevation of the highest flood level rim of any fixture served by the vent.

Note: See Appendix for further explanatory material.

(16) VENT TERMINALS. All vents and vent systems shall terminate in the open air in accordance with this subsection.

(a) *Extension above roofs.* Extensions of vents through a roof shall terminate at least 8" above the roof. Where the roof is to be used for any purpose other than weather protection, the vents shall extend at least 7 feet above the roof.

(b) *Waterproof flashings.* The penetration of a roof system by a vent shall be made watertight with an approved flashing.

(c) *Prohibited uses.* Vent terminals shall not be used as flag poles, support for antennas or other similar purposes.

(d) *Location of vent terminals.* 1. A vent shall not terminate under the overhang of a building.

2. All vent terminals shall be located:

a. At least 10 feet from an air intake;

b. At least 5 feet from a power exhaust vent;

c. At least 10 feet horizontally from or 2 feet above roof scuttles, doors and openable windows; and

d. At least 5 feet from or 2 inches above parapet walls.

3. Where a structure has an earth covered roof extending from surrounding grade, the vent extension shall run at least 7 feet above grade and terminate with an approved vent cap. The portion of vent pipe outside the structure shall be without joints, except one fitting may be installed where the pipe leaves the top or side of the structure.

(e) *Extension through wall.* Where approved by the department, a vent may terminate through an exterior wall. Such a vent shall terminate at least 10 feet horizontally from any lot line and shall terminate downward. The vent shall be screened and shall comply with par. (d).

(f) *Extensions outside buildings.* Drain or vent pipe extensions shall not be located or placed on the outside of an exterior wall of any new building, but shall be located inside the building.

(g) *Frost closure.* For protection against frost closure, each vent terminal shall be at least 2" in diameter. Where it is necessary to increase the diameter of the vent, the change in diameter shall be made at least 6" inside the building.

Note: See Appendix for further explanatory material.

(h) *Penetrations through grade.* Except when installation is in accordance with par. (d) 3., penetrations through grade shall terminate at least 12" above finished grade and terminate with a vent cap or return bend.

(17) COMBINATION DRAIN AND VENT SYSTEMS. In lieu of providing individual vents, fixtures may be vented in accordance with pars. (a) to (c).

(a) *Stacks.* 1. A drain stack may serve as a combination drain and vent system for fixtures in accordance with subd. 1. a. to e.

a. The drain stack shall not serve more than 3 fixtures. Each fixture shall be located on a separate floor level.

b. The drain stack shall be limited to serving fixtures with a drainage fixture unit value of no greater than 2.0. A urinal may not discharge into the combination drain and vent portion of the

stack. The largest drainage fixture unit value served by the stack shall determine the stack size as specified in Table 82.31-5.

c. The drain stack shall not be offset horizontally above the lowest fixture drain connection.

d. The developed length of any fixture drain from the trap weir to the drain stack shall not exceed the limits specified in Table 82.31-1.

e. The drain stack and its attendant vent shall be sized in accordance with Table 82.31-5.

Note: See Appendix for further explanatory material.

Table 82.31-5
STACK SIZING BY DFU VALUE

Drainage Fixture Unit (dfu) Value	Size of Stack (inches)
0.5	1½
1.0	2
2.0	3

2. A drain stack may serve as a combination drain and vent system for a kitchen sink and a laundry tray in accordance with subd. 2. a. to d.

a. One kitchen sink within a dwelling unit, with or without a food waste grinder or dishwasher connection shall connect to the drain stack above the laundry tray. No other fixtures may connect to the drain stack.

b. The drain stack shall be at least 2" in diameter below the kitchen sink connection and it shall be at least 4" in diameter below the laundry tray connection.

c. In lieu of the minimum sizes as required in subd. 2. b., the entire stack below the kitchen sink connection may be 3" in diameter.

d. The drain stack shall not offset horizontally above the fixture drain connection for the laundry tray.

(b) *Building drains.* A building drain or a building subdrain may serve as a combination drain and vent system for floor drains and floor outlet fixtures in accordance with subs. 1. to 6.

1. A vent or drain at least 2 inches in diameter shall be connected upstream of any building drain branch or building subdrain branch.

2. No more than 2 water closets may connect to the building drain or building subdrain by means of building drain branches or building subdrain branches.

3. a. That portion of the building drain or building subdrain between the connection of the building drain branch or building subdrain branch and the vent or drain required in subd. 1. shall be at least one pipe size larger than the minimum size permitted in Table 82.30-3 based on the total drainage fixture unit load, but not less than 3 inches.

b. The vent or drain required in subd. 1. shall be at least one-half the diameter of that portion of the building drain or building subdrain which is vented by the vent or drain, but may not be less than 2 inches in diameter.

c. A vent serving a drain required in subd. 1. shall be at least one half the diameter of that portion of the building drain or building subdrain which is vented by the system, but may not be less than 2 inches in diameter.

4. The trap of a floor drain or a floor outlet fixture, except a water closet, connected to a building drain branch or building subdrain branch shall be at least 3" in diameter.

5. A building drain branch or building subdrain branch may not connect to a building drain or building subdrain downstream from the base fitting of a drain stack 2" or larger in diameter within the distance equal to 20 pipe diameters of the building drain or building subdrain.

6. The pitch and the developed length of the building drain branch or building subdrain branch may not exceed the limits specified in Table 82.31-1.

Note: See Appendix for further explanatory material.

(c) *Laboratory sink venting.* A horizontal drain may serve as a combination drain and vent system for island laboratory sinks in accordance with subds. 1. to 7.

1. A vent stack or a drain stack at least 2" in diameter shall be connected upstream of any fixture drain vented by the combination drain and vent system.

2. a. That portion of the horizontal drain between the connection of fixture drain and the vent stack or drain stack required in subd. 1. shall be at least one pipe size larger than the minimum size permitted in Table 82.30-2 based on total drainage fixture unit load.

b. The vent stack or drain stack required in subd. 1. shall be at least one-half the diameter of that portion of the horizontal drain which is vented by the stack, but may not be less than 2" in diameter.

c. A stack vent serving a drain stack required in subd. 1. shall be at least one half the diameter of that portion of the horizontal drain which is vented by the stack, but may not be less than 2" in diameter.

3. All fixture drains vented by the horizontal drain shall be at least 3" in diameter.

4. Fixture drains to be vented by the horizontal drain shall connect individually to the horizontal drain.

5. An individual vent or common vent shall be extended as high as possible under the sink enclosure and then returned vertically downward and connected to the horizontal drain. A cleanout shall be provided on the vent piping.

6. In lieu of connecting the vent to the horizontal drain which forms the combination drain and vent system, the vent may connect to a horizontal fixture drain vented by the combination drain and vent system. The pitch and developed length of the horizontal fixture drain shall not exceed the limits specified in Table 82.31-1.

7. Fixture drains to be vented by the horizontal drain shall not connect to a horizontal drain downstream from the base fitting of a drain stack 2" or larger in diameter within the distance equal to 20 pipe diameters of the horizontal drain serving the stack.

Note: See Appendix for further explanatory material.

(18) **PROHIBITED USES.** A vent or vent system shall not be used for purposes other than the venting of the plumbing system.

(a) *Boiler blowoff basin vents.* Vent piping from boiler blowoff basins shall not be connected to a vent or vent system serving a sanitary drain system, storm drain system or chemical waste system.

(b) *Chemical waste vents.* Vent piping for chemical waste systems shall not be connected to a vent system serving a sanitary drain system or storm drain system.

(c) *Steam vents.* Vents serving steam operated sterilizers, cleansing or degreasing equipment, pressing machines or any other apparatus which normally discharges steam into the vent shall not be connected to a vent or a vent system serving a sanitary drain system, storm drain system or chemical waste system.

History: Cr. Register, February, 1985, No. 350, eff. 3-1-85; am. (11) (a), (17) (b) 3, b, and (c) 2, b., r. and rec. (11) (b), r. (13) (a) 2., cr. (17) (b) 3, c. and (c) 2, c., Register, May, 1988, No. 389, eff. 6-1-88; reprinted to correct (17) (c) 4., Register, February, 1991, No. 422; cr. (4) (b) 4. and (17) (a) 1, f., r. and rec. (5) (c) 1, c. and (17) (c) 4., am. (5) (c) 2, c., (10) (intro.), (b) 1., (11) (b), (17) (a) 1, e. and (17) (b), Register, August, 1991, No. 428, eff. 9-1-91; am. (6) (c), (7) (b), (10) (intro.), (a), (b) 1., (c), (13) (a) 1, c., (c) (intro.), 1. and 4., r. (16) (h), Register, February, 1994, No. 458, eff. 3-1-94; CR 02-002: renum. (8) to be (8) (a) and am., cr. (8) (b), (14) (j) and (16) (h), am. (11) (a), (12) (intro.), (a), (13) (c) 1. (17) (a) 1. (intro.) to b., and Table 82.31-4, r. and rec. Table 82.31-5, Register April 2003 No. 568, eff. 5-1-03; CR 08-055: am. (4) (a), (10) (c), (13) (a) 1, e., (14) (g) 2., (17) (a) 1, e., (b) 1. and 3., r. and rec. (5) and (6), r. (17) (a) 1, f. Register February 2009 No. 638, eff. 3-1-09; correction in (17) (a) 1. (intro.) made under s. 13.92 (4) (b) 7., Stats., Register February 2009 No. 638.

Comm 82.32 Traps and direct fixture connections.

(1) **SCOPE.** The provisions of this section set forth the requirements for the types and installation of traps and direct fixture connections.

(2) **MATERIALS.** All traps and fixture connections shall be of approved materials in accordance with ch. Comm 84.

(3) **GENERAL.** Each plumbing fixture, each compartment of a plumbing fixture and each floor drain shall be separately trapped by a water seal trap, except as provided in par. (a) or as otherwise permitted by this chapter. A fixture shall not be double trapped.

(a) *Trap exceptions.* The plumbing fixtures listed in subds. 1. to 3. shall not be required to be separately trapped:

1. Fixtures having integral traps;

2. Compartments of a combination plumbing fixture installed on one trap, provided:

a. No compartment is more than 6" deeper than any other;

b. The distance between the compartments' waste outlets farthest apart does not exceed 30"; and

c. No compartment waste outlet is equipped with a food waste grinder.

3. Storm drains as provided in s. Comm 82.36 (12) (a).

(b) *Trap seals.* Each trap shall provide a liquid seal depth of not less than 2" and not more than 4", except as otherwise specified in this chapter.

(c) *Loss of trap seal.* A trap seal primer valve may be installed on a trap subject to high rates of evaporation.

1. A trap seal primer valve or other means of trap seal protection acceptable to the department shall be provided for a trap subject to seal loss due to evaporation.

Note: Liquids acceptable to use for reducing trap seal evaporation include mineral oil, vegetable oil, propylene glycol and glycerin.

2. Trap seal primer valves shall conform to ASSE 1018.

Note: A list of referenced standards is contained in ch. Comm 81.

(d) *Design.* Traps shall be self-scouring and shall not have interior partitions, except where such traps are integral with the fixture. Uniform diameter P-traps shall be considered self-scouring.

(e) *Size.* Traps shall be of diameters not less than those specified in Table 82.30-1 of s. Comm 82.30.

(f) *Prohibited traps.* The installation of the types of traps listed in subds. 1. to 6. shall be prohibited:

1. Bell traps;

2. Drum traps, except where specifically approved by the department;

3. S-traps which are not integral parts of fixtures;

4. Separate fixture traps which depend on interior partitions for the trap seal;

5. Traps which depend upon moving parts to maintain the trap seal; and

6. Traps which in case of defect would allow the passage of sewer air.

(4) **INSTALLATION.** (a) *Setting of traps.* All traps shall be rigidly supported and set true with respect to the water level and so located as to protect the water seals, and shall be protected from freezing and evaporation.

(b) *Distance from fixture drain outlets.* 1. "Vertical distance." Except as provided in subd. 1. a. to c., the vertical distance between the top of the fixture drain outlet and the horizontal center line of the trap outlet shall not exceed 15".

a. The vertical distance between the top of the strainer of a floor drain or the opening of a standpipe receptor and the horizontal center line of the trap outlet shall not exceed 36".

b. The vertical distance between the top of the fixture drain outlet of a pedestal fixture or a cuspidor and the horizontal center line of the trap outlet shall not exceed 60".

c. The vertical distance between the water level in the bowl of a floor outlet water closet and the center line of the horizontal portion of the fixture drain shall not exceed 36".

d. The vertical distance from the inlet to the horizontal centerline of the fixture drain for a campsite receptor, exterior storm drain inlet, or a receptor for a sanitary dump station may exceed 3 feet so as to permit the trap to be installed below the predicted depth of frost.

2. 'Horizontal distance.' Except as provided in subd. 2. a. and b., the horizontal distance between the vertical centerline of a fixture drain outlet and the vertical centerline of the trap inlet shall not exceed 15".

a. The horizontal distance for a pedestal drinking fountain shall not exceed 24".

b. The horizontal distance for an exterior sanitary area drain or a residential garage floor drain discharging through an interior trap shall not exceed 25 feet.

c. The minimum horizontal distance between the vertical centerline of the outlet from a floor-mounted water closet and a 3-inch double tee shall be 30 inches.

Note: See Appendix for further explanatory material.

(5) **DIRECT FIXTURE DRAIN CONNECTION.** Except as provided in s. Comm 82.33, all plumbing fixtures and appliances discharging wastes shall connect directly to a drain system.

(a) *Floor drains.* 1. Floor drains shall be so located as to be accessible for cleaning purposes.

2. A floor drain receiving the wash from garbage cans shall be at least 3" in diameter.

(b) *Kitchen sinks.* Horizontal drain piping serving a kitchen sink trap shall not connect to vertical drain piping by means of a double sanitary tee.

(c) *Water closets.* A water closet shall discharge through a drain pipe or fitting with a minimum diameter of 3".

1. A floor mounted wall outlet water closet shall connect to a 4 inch or 4 x 3 inch closet collar fitting or to a horizontal or vertical carrier type fitting.

2. A floor outlet water closet shall connect to a 4 inch or 4 x 3 inch closet collar fitting. A 4 x 3 inch closet bend fitting may be installed where a 4 inch closet collar fitting is used.

3. A wall mounted wall outlet water closet shall connect to a horizontal or vertical carrier type fitting.

4. Two water closets discharging to a vertical drain from opposite sides by means of the same fitting shall be installed in accordance with subd. 4. a. and b.

a. Where the vertical drain is 3" in diameter, the fitting for floor outlet water closets shall be a 3 inch double wye pattern fitting.

b. Where the water closets are wall outlet types the fitting shall be a double wye pattern fitting or a carrier-type fitting.

(d) *Blowout-type fixtures.* Blowout-type plumbing fixtures shall be installed in accordance with the approval of the department.

History: Cr. Register, February, 1985, No. 350, eff. 3-1-85; am. (4) (a), cr. (5) (intro.) and (d), Register, May, 1988, No. 389, eff. 6-1-88; am. (4) (b) 1. b., Register, April, 2000, No. 532, eff. 7-1-00; CR 02-002: r. and recr. (3) (c) 1. and (4) (b) 2., am. (4) (b) 1. b., cr. (4) (b) 1. d., Register April 2003 No. 568, eff. 5-1-03; CR 02-129: am. (3) (intro.) Register January 2004 No. 577, eff. 2-1-04; CR 04-035: am. (3) (a) 3. Register November 2004 No. 587, eff. 12-1-04; CR 08-055: cr. (4) (b) 2. c. Register February 2009 No. 638, eff. 3-1-09.

Comm 82.33 Indirect and local waste piping.

(1) **SCOPE.** (a) The provisions of this section set forth the requirements for the installation of indirect waste piping and local waste piping.

(b) Indirect waste piping and local waste piping draining the fixtures, appliances and devices having a public health concern, including but not limited to those listed in Table 82.33-1, shall be considered as plumbing and shall comply with the provisions of this section.

(2) **MATERIALS.** Indirect waste piping more than 30" in length and all local waste piping shall be of approved materials in accordance with ch. Comm 84.

(3) **SIZE.** Except as provided in pars. (a) and (b), indirect waste piping more than 30" in length and all local waste piping shall be sized in accordance with s. Comm 82.30.

(a) Indirect or local waste piping not exceeding 20 feet in length for refrigerated food display cases may not be less than one inch in diameter.

(b) Indirect waste piping, attached to an appliance, appurtenance or equipment through which pressurized waste is discharged, shall be sized in accordance with specifications of the manufacturer of the appliance, appurtenance or equipment.

Table 82.33-1

TYPES OF FIXTURES, APPLIANCES AND DEVICES OF A PUBLIC HEALTH CONCERN

Refrigerated food storage rooms and compartments

Refrigerated food display cases

Ice compartments

Vending machines

Steam tables and kettles

Food preparation sinks

Potato peelers

Egg boilers

Boiler blowoff basin outlet drains

Coffee makers and urns

Food processing equipment

Baptismal founts

Clothes washers and extractors

Dishwashers

Stills

Sterilizers

Bar and soda fountains

Boiler blowoff basin outlet drains

(4) **INSTALLATION.** Indirect waste piping and local waste piping shall be so installed as to permit access for flushing and cleaning.

(5) **TRAPS.** (a) *Indirect waste piping.* 1. Gravity flow indirect waste piping more than 30" in length shall be provided with a trap in accordance with s. Comm 82.32 (4), except indirect waste piping draining a sterilizer shall not be trapped.

2. All indirect waste piping draining a refrigerated food storage room, compartment or display case shall be provided with a trap in accordance with s. Comm 82.32 (4).

(b) *Local waste piping.* Local waste piping handling sanitary wastes and more than 30" in length shall be provided with a trap in accordance with s. Comm 82.32 (4).

(6) **MAXIMUM LENGTH.** Indirect waste piping and local waste piping handling sanitary wastes shall not exceed 30 feet in length horizontally nor 15 feet in length vertically.

Note: See Appendix for further explanatory material.

(7) **AIR-GAPS AND AIR-BREAKS.** All indirect waste piping and all local waste piping shall discharge by means of an air-gap or air-break into a receptor.

(a) *Air-gap installation.* The installation of an air gap shall conform to any of the following requirements:

1. The distance of an air gap shall comply with one of the following:

a. The distance of an air gap serving indirect waste piping one inch or less in diameter and a receptor shall be at least twice the diameter of the indirect waste piping.

b. The distance of an air gap between indirect waste piping larger than one inch in diameter and a receptor shall not be less than 2 inches.

2. The installation of all air-gap fittings shall comply with ASME A112.1.3.

3. The installation of a residential dishwashing machine manufactured air gap shall comply with ASSE 1021.

(b) *Air-break installation.* The air-break between indirect waste piping or local waste piping and the receptor shall be accomplished by extending the indirect waste piping or local waste piping below the flood level rim of the receptor and terminating at an elevation above the trap outlet.

Note: See Appendix for further explanatory material.

(8) RECEPTORS. A receptor receiving the discharge from indirect waste piping or local waste piping shall be of a shape and capacity as to prevent splashing or flooding. Receptors shall be installed in accordance with this subsection and shall be accessible.

(a) *Waste sinks and standpipes.* A waste sink or a standpipe serving as a receptor shall have its rim at least one inch above the floor.

(b) *Floor sinks.* A floor sink serving as a receptor shall be equipped with a removable metal basket over which the indirect waste piping or local waste piping is to discharge, or the floor sink shall be equipped with a dome strainer. Indirect waste piping or local waste piping shall not discharge through a traffic grate, but shall terminate over an ungrated portion of the floor sink.

(c) *Local waste piping.* Local waste piping may not receive discharge from another local waste pipe.

(d) *Other receptors.* A plumbing fixture may not be used as a receptor for indirect or local waste piping, except as provided in subs. 1. to 7.

1. The indirect waste piping of a portable dishwasher or water treatment device serving one or 2 outlets may discharge into a kitchen sink of a dwelling unit or to a branch tail piece serving a kitchen sink.

2. The indirect waste piping of an automatic clothes washer or water treatment device may discharge into a laundry tray.

3. The indirect or local waste piping serving a cross connection control device or assembly, water treatment device, air conditioner, humidifier or furnace condensate may discharge into a branch tailpiece serving a laundry tray.

4. The local waste piping serving a water heater temperature and pressure relief valve, water treatment device, cross connection control device or assembly, humidifier, sterilizer, or a furnace or air conditioner may discharge into the riser of a floor drain when installed in accordance with sub. (7) (b).

5. The indirect or local waste piping serving a water heater temperature and pressure relief valve, water treatment device, cross connection control device or assembly, or a furnace or air conditioner may discharge to a floor served by a floor drain so as not to create a health or safety hazard.

6. The indirect or local waste piping serving a water heater temperature and pressure relief valve or water treatment device may discharge through the cover of a clear water sump so as not to adversely affect floats by means of a fixed air gap installed in accordance with subs. (7) (a) 2. and (8).

7. The indirect waste piping serving a dental mold grinder may discharge into the riser or a trap serving a laboratory sink that is provided with a plaster trap and is installed within 3 feet of the mold grinder.

Note: See Appendix A-82.33 (8) (a) to (d) for further explanatory material.

(9) INDIRECT WASTE PIPING REQUIRED. (a) *Boilers, pressure tanks and relief valves.* Boilers, pressure tanks, relief valves and

similar equipment discharging to a drain system shall be by means of an air-gap.

1. Steam pipes shall not connect or discharge to any part of a plumbing system.

2. a. Except as provided in subd. 2. b., wastewater more than 160° F in temperature shall be discharged by means of indirect waste to the plumbing system.

b. Steam condensate blow down shall be cooled to 160°F in temperature prior to discharging to a plumbing system.

(b) *Clear water.* When discharging to a plumbing system, all clear water shall discharge by means of an air-gap.

(c) *Clothes washers.* 1. 'Residential types.' Residential-type clothes washers shall discharge into the sanitary drain system by means of an air-break.

a. A standpipe receptor may not extend more than 36 inches nor less than 18 inches above the centerline of the trap outlet.

b. A standpipe receptor shall terminate at least 26 inches but not more than 48 inches above the floor on which the clothes washer is located.

2. 'Self-service laundries.' Pumped-discharge automatic clothes washing equipment in laundrettes, laundromats and self-service laundry establishments shall have the wastes discharge to a drain system by means of standpipes. The standpipes shall be installed in accordance with subd. 1.

a. The maximum number of washers which may be connected to a trap shall be in accordance with Table 82.33-2.

b. Washer wastes shall not be discharged to gutters, troughs, local waste piping, indirect waste manifold or other similar connections.

3. 'Commercial.' Gravity discharge-type clothes washing equipment shall discharge by means of an air-break or by other approved methods into a floor receptor, trench or trough.

a. The receptor shall be sized to hold one full simultaneous discharge load from every machine draining into the receptor.

b. The size of the receptor drain shall be determined by the manufacturer's discharge flow rate and the frequency of discharge.

Note: See Appendix for further explanatory material.

c. All wastes from the washers shall flow through a Commercial laundry interceptor as specified in s. Comm 82.34.

Table 82.33-2
WASHER CONNECTIONS

Trap Diameter	Maximum Number of Washers
2 inches	2 machines
3 inches	3 machines
4 inches	4 machines

(d) *Dishwashing machines.* All dishwashing machines shall discharge to the sanitary drain system.

1. 'Residential type.' The indirect waste piping from a residential-type dishwashing machine shall not exceed a developed length of 10 feet. The indirect waste piping from a residential-type dishwashing machine shall be installed in accordance with one of the following methods:

a. Where an air-gap or air-break is located below the countertop, the indirect waste piping from the dishwashing machine shall discharge to a standpipe. The standpipe shall be at least 1 ½ inches in diameter and shall extend at least 15 inches above the trap weir.

b. Where an air-gap or air-break is located above the countertop, the indirect waste piping from the dishwashing machine shall discharge to local waste piping. The local waste piping shall connect to the kitchen sink branch tailpiece above the trap inlet, the standpipe or to the dishwashing machine connection of a food waste grinder. When the local waste piping discharges to a standpipe, the standpipe shall be at least 1 ½ inches in diameter and

shall extend at least 15 inches above the trap weir. Where a hose is used for local waste piping, the developed length shall not exceed 18 inches.

2. 'Commercial'. Commercial dishwashing machines shall discharge into a sanitary drain system by means of an air-gap or air-break into a trapped and vented receptor. The indirect waste piping may not be more than 30 inches in length.

(e) *Drips and drain outlets*. Appliances, devices and apparatus not defined as plumbing fixtures which have drip or drain outlets, which discharge to the plumbing system, shall discharge into an approved receptor by means of an approved air-gap or air-break.

(f) *Elevator drains*. 1. All drains serving elevator pits shall discharge to the storm drain system as specified in s. Comm 82.36 (4).

2. Drains serving elevator pits shall not connect directly with the storm drain system by means of gravity flow piping.

3. A sump may not be located in an elevator machine room.

4. A drain serving an elevator pit that discharges to a sump shall have a submerged inlet constructed to maintain a minimum 6" trap seal.

5. A sump located in an elevator pit may only receive storm or clear water waste from the elevator pit or the elevator machine room, or both.

Note: See Appendix for further explanatory material.

(g) *Food handling establishments*. Plumbing fixtures, devices and appurtenances installed in food handling establishments engaged in the storage, preparation, selling, serving or processing of food shall be installed in accordance with this paragraph.

1. 'Bar and soda fountain sinks.' Where a bar or soda fountain sink is so located that the trap for the sink cannot be vented as specified in s. Comm 82.31, the sink drain shall discharge to the sanitary drain system through indirect waste piping.

a. Where the indirect waste piping is not trapped, the wastes shall be discharged by means of an air-gap.

b. Where the indirect waste piping is trapped, the wastes shall be discharged by means of an air-gap or air-break.

2. 'Beer taps, coffee makers, glass fillers and soda dispensers.' The drip pan from a beer tap, coffee maker, glass filler, soda dispenser or similar equipment shall discharge to the sanitary drain system through indirect waste piping by means of an air-break or air-gap.

3. 'Novelty boxes, ice compartments and ice cream dipper wells.' Novelty boxes, ice compartments and ice cream dipper wells shall discharge to the sanitary drain system through indirect waste piping by means of an air-gap.

a. The indirect waste piping shall not exceed 30" in length.

b. The indirect waste piping draining a novelty box or ice compartment may not discharge or connect to the indirect waste piping or local waste piping of any other fixture, appliance or device other than a novelty box or ice compartment.

4. 'Refrigerated food storage rooms, compartments and display cases.' Drains serving refrigerated food storage rooms, compartments or display cases shall discharge to the sanitary drain system through indirect waste piping. The indirect waste piping shall drain by gravity to a receptor by means of an air-gap or air-break. Where an air-break is installed, the flood level rim of the receptor shall be at least 2" below the top of the fixture strainer or drain opening in the refrigerated room, compartment or display case.

5. 'Enclosed food processing equipment.' Coffee urns, egg boilers, potato peelers, steam kettles, steam tables, vending machines and similar types of enclosed food processing equipment shall be discharged to the sanitary drain system through indirect waste piping by means of an air-gap.

6. 'Food preparation.' Open culinary sink compartments for thawing or washing food shall discharge to the sanitary drain system through an independent connection by means of an air-gap.

The fixture drain upstream of the air-gap shall not exceed a length of 30".

Note: See Appendix for further explanatory material.

(h) *Sterilizers*. Appliances, devices or apparatus, such as stills, sterilizers and similar equipment requiring waste connections and used for sterile materials, shall discharge through indirect waste piping to the sanitary drain system by means of an air-gap.

Note: See s. Comm 82.50 regarding sterilizer wastes.

(i) *Cross connection control devices or assemblies*. Where a receptor is provided, the vent port discharge from cross connection control devices or assemblies shall discharge to the receptor by means of an air-gap.

(j) *Vacuum systems—central units*. Central vacuum units shall discharge by means of an air-gap or air break.

(k) *Swimming pools*. 1. The backwash and drain wastewater from a swimming pool, wading pool or whirlpool shall discharge in accordance with Table 82.38-1.

2. The discharge from deck drains serving indoor pools shall be directed to the sanitary sewer via an air-gap.

3. The discharge from deck drains serving outdoor pools shall be directed to the storm sewer by way of an air-gap or to grade.

4. The requirements for sewer connections as specified in ch. Comm 90 applies to all public swimming pools.

(10) **WATER TREATMENT DEVICES**. (a) The waste discharge of a water treatment device to the drain system shall be protected in accordance with s. Comm 82.41 with respect to cross connection control.

(b) The indirect waste piping or tubing from a water treatment device shall be of a material conforming to one or more of the standards listed in Tables 84.30-8 or 84.30-11.

Note: For appliances, devices and equipment not included in this section or other sections contact the department for information and proposed installation review.

History: Cr. Register, February, 1985, No. 350, eff. 3-1-85; r. and rec. Table 82.33-1 and (9) (g) 5., cr. (8) (c) 3., (9) (g) 6. and (k), Register, May, 1988, No. 389, eff. 6-1-88; r. and rec., (3), am. (9) (c) 1. a., (d) 2. and (g) 4., Register, August, 1991, No. 428, eff. 9-1-91; am. (8) (d) 1., 2. and (9) (g) 3. b., r. (9) (k), cr. (10), Register, February, 1994, No. 458, eff. 3-1-94; correction in (9) (i) 5., made under s. 13.93 (2m) (b) 7., Stats., Register, February, 1994, No. 458; r. and rec. (9) (f), Register, April, 1998, No. 508, eff. 5-1-98; correction in (9) (i) 5. made under s. 13.93 (2m) (b) 7., Stats., Register, April, 1998, No. 508; r. and rec. (9) (i), cr. Table 82.33-3, Register, December, 2000, No. 540, eff. 1-1-01; CR 02-002: am. (5) (a) 2., (7) (b), (9) (c) 1. b., (e), (g) 6., renum. (8) (a) 1., (9) (a) 2. and (10) to be (8) (a), (9) (a) 2. a. and (10) (a) and am. (9) (a) 2. a., r. (8) (a) 2., r. and rec. (8) (c), (d), (9) (b), (d) 1. and (i), cr. (9) (a) 2. b., (c) 1. c., and (10) (b) Register April 2003 No. 568, eff. 5-1-03; CR 02-129: am. (9) (c) 1. b., r. (9) (d) 3. and table 82.33-3, cr. (9) (k) Register January 2004 No. 577, eff. 2-1-04; CR 08-055: r. and rec. (7) (a), cr. (8) (d) 6. and 7., am. (9) (c) 1. a., b. and (f) 1., r. (9) (c) 1. c. Register February 2009 No. 638, eff. 3-1-09; correction in (8) (d) (intro.) made under s. 13.92 (4) (b) 7., Stats., Register February 2009 No. 638.

Comm 82.34 Wastewater treatment devices.

(1) **SCOPE**. The provisions of this section set forth the requirements for design and installation of plumbing wastewater treatment devices, appurtenances and systems, including but not limited to interceptors, catch basins, and dilution and neutralizing basins.

(2) **MATERIALS**. All piping, devices and appliances for wastewater treatment devices, appurtenances and systems shall be of approved materials in accordance with ch. Comm 84.

(3) **GENERAL**. Any deleterious waste material which is discharged into a plumbing system shall be directed to a wastewater treatment device. The wastewater treatment device shall be capable of separating, diluting or neutralizing the deleterious waste material to a degree that the wastewater is no longer deleterious. Wastewater treatment devices that retain any waste materials shall be designed and installed to facilitate periodic removal or treatment, or both.

(a) *Treatment for reuse*. 1. Except as provided in subd. 2., wastewater discharged from water closets or urinals shall not be reused for drinking water.

2. All treatment works permitted by the department of natural resources, or a POWTS which includes an in situ soil dispersal or

treatment component may treat wastewater discharged from water closets or urinals for reuse.

(b) *Deleterious waste materials.* For the purpose of this subsection, deleterious waste materials include any waste material, other than that from dwelling units, which may:

1. Congeal, coagulate or accumulate in drains and sewers, thereby, creating stoppages or retarding the discharge flow;
2. Retard or interfere with municipal sewage treatment processes;
3. Pass through a treatment process and pollute the watercourse receiving the treatment effluent;
4. Create explosive, flammable, noxious, toxic or other hazardous mixtures of materials; or
5. Damage, destroy or deteriorate sewers or piping materials or structures.

Note: See ch. Comm 10 as to flammable and combustible liquids.

(c) *Private disposal systems.* The special or industrial wastes from any plumbing system which are not discharged into a public sewer system shall be treated or disposed in compliance with the rules of the state agency having jurisdiction. The treatment or disposal system shall be installed so as not to endanger any water supply which is or may be used for drinking, culinary or bathing purposes, or which may create a nuisance, unsanitary conditions or water pollution.

(d) *Velocity control.* Interceptors, catch basins and other similar devices shall be designed, sized and installed so that flow rates shall be developed and maintained in a manner that solid and floating materials of a harmful, hazardous or deleterious nature will be collected in the interceptor for disposal.

(e) *Maintenance.* All devices installed for the purpose of intercepting, separating, collecting, or treating harmful, hazardous or deleterious materials in liquid or liquid-borne wastes shall be operated and cleaned of intercepted or collected materials or of any residual from treatment at such intervals which may be required to prevent their passage through the interceptor.

(f) *Service reassembly.* Any fixed orifice, vent or trap of an interceptor, catch basin or other similar device shall remain intact and shall not be removed or tampered with except for cleaning purposes. After service, all parts of the interceptor, collector or treatment device, such as baffles, weirs, orifice plates, channels, vents, traps, tops, and fastening bolts or screws shall be replaced in proper working position.

(g) *Location.* 1. Interceptors, catch basins and other similar devices shall be accessible for service, maintenance, repair and inspection.

a. No interceptor, catch basin or similar device may be surrounded or covered as to render it inaccessible for service or inspection.

b. No interceptor, catch basin or similar device may have its top located more than 6 feet above the surrounding floor.

c. Enough space shall be provided to enable the removal of any interior parts of the interceptor, catch basin or similar device.

d. At least 18" of clear space shall be provided above the top of the interceptor, catch basin or similar device.

2. An interceptor, catch basin, or similar device shall not be located within 25 feet of a water well.

(h) *Disposition of retained materials.* Deleterious waste materials retained by an interceptor, catch basin or similar device shall not be introduced into any drain, sewer or natural body of water without approval of the state agency having jurisdiction.

(4) **GARAGE FLOOR AREA WASTEWATER.** (a) *Garages for public buildings and facilities.* 1. Where a drain will be installed to receive the wastewater from floor areas of public buildings and facilities on which self-propelled land, air or water vehicles can be driven, the wastewater shall discharge using one of the following methods:

a. In areas where vehicles will be serviced, the wastewater shall discharge through a garage catch basin or oil interceptor connected to a municipal sewer or holding tank approved to receive industrial wastewater.

b. In areas where vehicles will be driven or stored, the wastewater shall discharge through a floor drain equipped with a solid bottom sediment bucket, garage catch basin or oil interceptor.

2. Garage catch basins design shall conform to all of the following:

a. The holding area of the catch basin shall be watertight.

b. The catch basin shall have a minimum inside diameter of 36".

c. The minimum depth of the basin shall be 24" measured from the lowest portion of the trap on the outlet of the basin.

d. The outlet of the basin shall be at least 4" in diameter and trapped with a water seal of at least 6" and constructed on the interior or exterior of the basin. Where an external trap is provided, the trap shall be within 36" of the basin.

e. Except as provided in subd. 5., the water line in the basin shall be at least 2" below all horizontal drains discharging into the basin. Where an external trap is provided, the measurement point on the horizontal drain shall be upstream of the trap.

f. The basin shall be provided with a cover at least 24" square or 24" in diameter.

g. Gravity drains from fixtures serving garage floor areas located on different floors from the basin may discharge into the basin if the drain stack carrying the wastewater is located at a distance equal to at least 20 times the inside diameter of the horizontal piping upstream of the basin.

h. Catch basins with solid covers shall be vented in accordance with sub. (8) (c).

3. Drains with traps may connect to the garage catch basin under all of the following conditions:

a. The trap shall be a minimum of 3" in diameter.

b. Except as provided in subd. 3. c., the developed length from all trap outlets to the basin shall not exceed the distance as specified in Table 82.31-1.

c. Where the maximum distance exceeds that as specified in Table 82.31-1, the trap shall be vented in accordance with s. Comm 82.31 (3) and the connection to the basin shall form a 6-inch trap seal. The trap seal may be constructed on either the interior or exterior of the basin, but within 36" of the basin.

4. Drains without traps may discharge into a garage catch basin under all of the following conditions:

a. The fixture drain shall have a minimum 4-inch inside diameter.

b. The fixture drain shall be piped with a 6-inch water seal constructed either on the interior or exterior of the basin.

c. An exterior trap shall be constructed within 36" of the basin.

d. The developed length of the fixture drain shall not exceed the distance equal to 24 times the diameter of the fixture drain.

e. Fixture drains shall individually discharge into a garage catch basin.

5. Pressurized drains from garage floor areas discharging to a garage catch basin shall conform to all of the following conditions:

a. The pressurized drain piping shall terminate inside the basin with a 6-inch submerged inlet. The termination shall be at least 12" above the floor of the basin.

b. The pressurized equipment, devices and piping shall be designed and installed to produce a maximum velocity of 2 feet per second at the point of connection to the basin.

Note: Plans for garage floor discharge-holding tanks may require plan approval by the department of natural resources.

(b) *Garages for one- and 2-family dwellings.* 1. Floor drains serving garages for one- and 2-family dwellings shall be provided with a solid bottom sediment basket.

Note: See Appendix for further explanatory material.

2. a. Except as permitted in subd. 2. b., catch basins serving garages for one- and 2-family dwellings shall be designed and installed in accordance with par. (a) 2.

b. The minimum inside diameter of catch basins serving garages for one- and 2-family dwellings shall be 18 inches.

(c) *Grates for garage catch basins, floor drains and trenches.* A garage catch basin, floor drain and trench drain shall be provided with an approved, removable cast iron or steel grate of a thickness and strength for the anticipated loads. The grate shall have an available inlet area equal to at least the outlet drain for the catch basin, floor drain or trench drain.

(5) GREASE AND OIL TREATMENT. (a) All plumbing installations for occupancies, other than dwelling units, where grease, fats, oils or similar waste products of cooking or food are introduced into the drain system shall be provided with grease and oil treatment in accordance with this subsection.

(b) *General.* 1. 'Public sewers.' All new, altered or remodeled plumbing systems which discharge to public sewers shall be provided with one or more grease interceptors.

a. Where one or more exterior grease interceptors are provided all, and only, kitchen wastes shall be discharged to an exterior interceptor.

b. Except as required in subd. 1. c. or d., where one or more interior grease interceptors are provided the wastes from a food waste grinder, a sanitizing compartment of a sink or a rinse compartment of a sink, may bypass the interceptor or interceptors.

c. The wash compartment of a scullery sink shall discharge through a grease interceptor.

d. The pre-wash compartment not discharging through a garbage disposal shall discharge through a grease interceptor.

2. 'Private onsite wastewater treatment systems.' All new, altered or remodeled plumbing systems which discharge to private onsite wastewater treatment systems shall be provided with exterior grease interceptors.

a. Except as provided in subd. 2. b., only kitchen and food wastes shall be discharged to an exterior grease interceptor.

b. For remodeling, when it is not practicable to separate kitchen and toilet wastes, combined kitchen wastes and toilet wastes may be discharged directly to a private onsite wastewater treatment component tank or tanks which conform to par. (c). The required capacity of a grease interceptor shall be added to the required septic tank capacity as specified in ch. Comm 83.

c. For holding tank installations, the combined kitchen and toilet wastes may discharge directly to a holding tank where the location accepting the pumpage from the tank provides written acceptance of the combined waste to the department.

3. 'Existing installations.' The department may require the installation of any treatment device deemed necessary by the department for existing plumbing installations where the waterway of a drain system, sewer system or private onsite wastewater treatment system is reduced or filled due to grease.

(c) *Exterior grease interceptors.* Exterior grease interceptors shall receive the entire waste discharge from kitchens or food processing areas. All exterior interceptors shall be designed and constructed in accordance with this paragraph, so as to constitute an individual structure.

1. 'Design.' a. The liquid depth of the interceptor shall not be less than 42" nor more than an average of 72".

b. A rectangular interceptor tank shall have a minimum width of 36" and a minimum length of 72". The longest dimension of the tank shall be parallel to the direction of waste flow.

c. A horizontal-cylindrical interceptor tank shall have a minimum inside diameter of 52" and a minimum length of 72". The longest dimension of the tank shall be parallel to the direction of waste flow.

d. Vertical-cylindrical interceptor tanks shall have a minimum inside diameter of 72".

e. Each prefabricated interceptor tank shall be clearly marked to indicate liquid capacity and the name and address or registered trademark of the manufacturer. The markings shall be impressed into or embossed onto the outside wall of the tank immediately above the outlet opening. Each site-constructed concrete tank shall be clearly marked at the outlet opening to indicate the liquid capacity. The marking shall be impressed into or embossed onto the outside wall of the tank immediately above the outlet opening.

f. The inlet and outlet openings of interceptor tanks or tank compartments shall be provided with, open-end sanitary tee fittings or baffles, so designed and constructed as to distribute the flow and retain the grease in the tank or tank compartments. The sanitary tee fittings or baffles shall extend at least 6" above the liquid level. At least 2" of clear space shall be provided above the top of the sanitary tee fittings or baffles. The sanitary tee fitting or baffle at the inlet opening shall extend below the liquid level of the tank a distance equal to $\frac{1}{3}$ of the total liquid depth. The sanitary tee fitting or baffle at the outlet opening shall extend below the liquid level of the tank a distance equal to $\frac{2}{3}$ of the total liquid depth. The waterline in the interceptor shall be at least 2" below the horizontal drain discharging to the interceptor.

g. Each compartment of an interceptor tank shall be provided with at least one manhole opening located over either the inlet or outlet opening. Additional manhole openings shall be provided such that no interior compartment wall of a tank is more than 4 feet from the edge of the manhole opening. The distance between manhole openings serving the same compartment shall not exceed 8 feet. Manhole openings shall be not less than 23" in the least dimension. Manholes shall terminate at or above ground surface and be of approved materials. Steel tanks shall have a minimum 2" collar for the manhole extensions permanently welded to the tank. The manhole extension on fiberglass tanks shall be of the same material as the tank and an integral part of the tank. The collar shall have a minimum height of 2".

h. Manhole risers for interceptor tanks shall be provided with a substantial, fitted, watertight cover of concrete, steel, cast iron or other approved material. Manhole covers shall terminate at or above grade and shall have an approved locking device.

i. A minimum 4 x 6 inch permanent label shall be affixed to the manhole cover, identifying the interceptor tank with the words GREASE INTERCEPTOR. Where the tank acts as the septic tank and grease interceptor the label shall identify it as such. The wording used on the warning label shall be approved by the department, as part of the materials approval for the tank under ch. Comm 84.

j. An inlet or outlet opening which does not have a manhole opening as specified in subd. 1. g. shall be provided with an airtight inspection opening located over the inlet or outlet. The inspection opening shall be at least 4" in diameter. The inspection opening shall terminate at or above grade.

Note: See Appendix for further explanatory material.

2. 'Capacity and sizing.' The minimum liquid capacity of a grease interceptor shall be determined in accordance with the provisions of this subdivision, except no grease interceptor may have a capacity of less than 1000 gallons if the interceptor is to discharge to a private onsite wastewater treatment system or less than 750 gallons if the interceptor is to discharge to a municipal sewer system and treatment facility.

a. The minimum capacity of a grease interceptor serving a restaurant with seating shall be equal to C, where

$$C = S \times H \times A$$

where, S = Number of seats, with each drive-in car service space counting as 3 seats and each drive-up service window counting as 60 seats.

H = Hours per day that meals are served, at least 6 hours but not more than 12 hours.

A = Appliance factor:

0.75 for a kitchen with no dishwashing machine and no food waste grinder.

1.0 for a kitchen with either a dishwashing machine or a food waste grinder.

1.25 for a kitchen with both a dishwashing machine and a food waste grinder.

b. The minimum capacity of a grease interceptor serving a dining hall, hospital, nursing home, school kitchen, church kitchen or a kitchen for carryout or delivery service shall be equal to C, where:

$$C = \frac{M \times G \times H}{2 \times P}$$

where, M = Meals served per day.

G = 3 gallons per meal served.

H = Hours per day that meals are served, at least 6 hours but not more than 12 hours.

P = Meal periods per day; 1, 2 or 3.

c. The minimum capacity of a grease interceptor as determined in subd. 2. a. or b. may be halved for establishments with all paper service, but may not be less than 1000 gallons if the interceptor is to discharge to a private sewage system or less than 750 gallons if the interceptor is to discharge to a municipal sewer system and treatment facility.

3. 'Installation.' a. Grease interceptor tanks may not be located within 5 feet of a building or any portion of the building or swimming pool; 10 feet of a water service; 2 feet of a lot line; 10 feet of a cistern or 25 feet of a reservoir or high water mark of a lake, stream, pond or flowage.

Note: The department of natural resources under ch. NR 113 requires a minimum setback of 25 feet between a grease interceptor and a well.

b. Where a grease interceptor tank is installed in groundwater, the tank shall be adequately anchored.

c. Grease interceptor tanks shall be installed on a bedding of at least 3" in depth. The bedding material shall be sand, gravel, granite, limerock or other noncorrosive materials of a size that all will pass through a 3/4" sieve.

d. The backfill material for steel and fiberglass grease interceptor tanks shall be as specified in subd. 3. c. for bedding and shall be tamped into place. The backfill material for concrete grease interceptor tanks shall be soil material, of a size that will pass through a 4 inch screen and shall be tamped into place.

e. All joints on concrete risers and manhole covers for a grease interceptor shall be tongue and groove or shiplap type and sealed watertight using neat cement, mortar or bituminous compound. All joints on steel risers for a grease interceptor shall be welded or flanged and bolted and be watertight. All steel manhole extensions from a grease interceptor shall be bituminous coated inside and outside. All methods of attaching fiberglass risers for a grease interceptor shall be watertight and approved by the department.

Note: See Appendix A-82.30 (11) (d) for material reprinted from s. NR 812.08. Section NR 812.08 may have additional setback requirements to wells.

(d) *Interior grease interceptors.* 1. 'Flow rating.' An interior grease interceptor shall be capable of accommodating a flow of at

least 15 gallons per minute, but not less than the manufacturer's specifications.

2. 'Flow rate related to connected capacity.' Three-fourths of the total holding capacity in gallons of all fixtures and devices discharging to an interior grease interceptor, shall not exceed the value of the maximum flow rate which the interceptor can accommodate.

3. 'Grease holding capacity as related to flow rate.' The grease holding capacity in pounds shall not be less than double the value of the maximum flow rate which the interceptor can accommodate.

4. 'Flow controls.' Where required by the manufacturer, devices which control the rate of flow through an interior grease intercept shall be installed.

a. The flow control devices shall be accessible for inspection, service and cleaning.

b. Flow controls shall be installed in the drain branch leading to each fixture and shall be so rated that the combined flow from all combinations of discharge will not develop either sufficient static or velocity head so the established flow rate of the interceptor can be exceeded.

Note: See Appendix for further explanatory material.

5. 'Flow control vents.' Orifice type flow controls for an interior grease interceptor shall be vented in accordance with s. Comm 82.31.

6. 'Prohibited locations and types.' No water-cooled grease interceptor may be installed. No grease interceptor may be located where the surrounding temperatures, under operating conditions, are less than 40° F.

7. A maximum of 12 inches of horizontal inlet pipe may be submerged.

(e) *Prohibited treatment.* The introduction of grease or fat emulsifiers into a grease interceptor shall be prohibited.

(6) **AUTOMATIC CAR WASHES.** The wastes of floor drains and drain inlets of automatic car washes shall discharge through an approved car wash interceptor.

(a) *Design.* Except as provided in subds. 1. and 2. and par. (b), car wash interceptors shall be constructed and installed in accordance with sub. (4) (a) 2.

1. The interceptor's outlet shall be submerged to form a trap with a water seal of at least 15".

2. The bottom of the trap's water seal shall be at least 30" above the bottom of the interceptor.

(b) *Capacity.* The minimum liquid capacity of the interceptor shall be based on the maximum flow rate of water through the interceptor in gallons per minute.

1. Between the waterline and the bottom of the trap seal of the outlet, the interceptor shall have a capacity value equal to at least 5 times the maximum flow rate.

2. Below the bottom of the trap seal of the outlet, the interceptor shall have a capacity value equal to at least 15 times the maximum flow rate.

Note: See Appendix for further explanatory material.

(c) *Hand-held car washing wands.* The wastes of floor drains and drain inlets serving 2 or more hand-held car washing wands shall discharge through an approved car wash interceptor. The wastes of one hand-held car washing wand may discharge to a garage catch basin.

(d) *Recirculated water.* Where recirculated water is used for washing, the recirculated water shall be drawn from a separation chamber located upstream from the car wash interceptor.

(7) **COMMERCIAL LAUNDRIES.** Wastes from gravity dump-type clothes washing equipment shall be discharged through an approved laundry interceptor in accordance with this subsection.

(a) *Screening apparatus.* A laundry interceptor shall be equipped with a wire basket or other device which will prevent the

passage of solids, 1/2" or larger in diameter, string, buttons and other detrimental materials into the drain system.

(b) *Trench type interceptors.* A floor receptor, trench or trough as specified in s. Comm 82.33 (9) (c) 3., may serve as a laundry interceptor, if no oils or quantities of sand are discharged into it.

Note: See Appendix for further explanatory material.

(c) *In-line interceptor.* 1. In-line interceptors shall have a minimum inside diameter or horizontal dimension of 24".

2. An in-line interceptor shall be provided with an air-tight cover.

3. An in-line interceptor shall be provided with a vent.

a. The vent shall extend from above the flow line to a vent terminal in accordance with s. Comm 82.31 (16) or shall be connected to the venting system serving the sanitary drain system.

b. The diameter of the vent shall be at least one-half of the diameter of the interceptor's outlet, but not less than 2".

4. The outlet for an in-line interceptor shall be at least 4" in diameter. The outlet shall be submerged to form a trap with a water seal of at least 12". The bottom of the trap's water seal shall be at least 12" above the bottom of the interceptor.

5. The waterline in an in-line interceptor shall be at least 2" below the bottom of the inlet opening for the interceptor.

(8) **OIL AND FLAMMABLE LIQUIDS.** Oily and flammable wastewater that discharges to a building sewer shall be intercepted or treated by a means acceptable to the department.

(a) *Site-constructed interceptors.* Site-constructed interceptors shall be designed in accordance with the requirements in sub. (4) (a) 2.

(b) *Prefabricated oil interceptors and separators.* Prefabricated oil interceptors and separators shall be manufactured with adequate capacity for the anticipated load.

(c) *Venting.* Oil and flammable interceptors and separators shall be so designed to prevent the accumulation of explosive gases.

1. A covered interceptor or separator shall be provided with an individual vent of at least 3 inches in diameter. The vent shall extend from the top of the interceptor or separator or as high as possible, from the side of the interceptor or separator to a point at least 12 feet above grade.

2. The drain pipe to the interceptor or separator shall be provided with a fresh air inlet connected within 2 feet of the inlet of the interceptor or separator. The fresh air inlet shall terminate at least one foot above grade, but not less than 6 feet below the terminating elevation of the vent serving the interceptor or separator. The fresh air inlet shall be at least 3 inches in diameter.

Note: See Appendix for further explanatory material.

(9) **BOTTLING ESTABLISHMENTS.** Wastes containing glass of bottling establishments shall be discharged through an interceptor.

(10) **DAIRY PRODUCT PROCESSING PLANTS.** Dairy wastes from dairy product processing plants shall be discharged through an interceptor.

(11) **MEAT PROCESSING PLANTS AND SLAUGHTERHOUSES.** The wastes from meat processing areas, slaughtering rooms and meat dressing rooms shall be discharged through an approved interceptor to prevent the discharge of feathers, entrails, blood and other materials.

(12) **SAND INTERCEPTORS.** Sand interceptors and other similar interceptors for heavy solids shall be so designed and located as to be accessible for cleaning. The outlet for the interceptor shall be submerged to form a trap with a water seal of at least 12".

(13) **PLASTER AND HEAVY SOLIDS TRAP TYPE INTERCEPTORS.** Plaster sinks shall be provided with plaster and heavy solids trap type interceptors.

(a) The interceptor shall be installed as the fixture trap.

(b) The drain piping between the sink and the interceptor shall not exceed a length of 36".

Note: See Appendix for further explanatory material.

(14) **CHEMICAL WASTE PIPING SYSTEMS.** All chemical wastes having a pH level of less than 5.5 or more than 10.0 shall discharge to a holding tank for proper disposal or to a drain system in accordance with this subsection.

(a) *Chemical dilution and neutralizing basins.* 1. All chemical wastes discharging into a drain system shall be diluted, neutralized or treated to a pH level of 5.5 to 10.0 by passing through an approved dilution or neutralizing basin before discharging to a building sewer.

2. Dilution and neutralizing basins shall have the minimum retention capacities in accordance with one of the following requirements:

a. The minimum retention capacity shall be as specified in Table 82.34.

b. The minimum retention capacity shall be as per the manufacturer's specifications.

c. The minimum retention capacity for a quantity exceeding 150 sinks or for special uses or installations shall be approved by the department.

3. Where a sufficient supply of diluting water cannot be provided to a dilution or neutralizing basin, the basin shall be filled with marble or limestone chips of not less than one inch nor more than 3" in diameter to the level of the basin's outlet.

4. Either the inlet or outlet of a dilution or neutralizing basin shall be submerged to form a trap with a water seal of at least 4".

Table 82.34

MINIMUM CAPACITIES FOR DILUTION AND NEUTRALIZING BASINS

Maximum Number of Sinks	Minimum Retention Capacity in Gallons
1	5
4	15
8	30
16	55
25	100
40	150
60	200
75	250
100	350
150	500

(b) *Vents.* Vents for chemical waste systems shall be sized and installed in accordance with all of the following:

1. Dilution and neutralizing basins with submerged inlets shall have a sanitary vent connected to the basin and a chemical waste vent connected to the inlet pipe. The pitch and the developed length of the drain between the submerged basin inlet and the chemical waste vent shall be in accordance with Table 82.31-1.

2. Dilution and neutralizing basins with submerged outlets shall have a chemical waste vent connected to the basin and a sanitary vent connected to the outlet pipe. The pitch and the developed length of the drain between the submerged basin outlet and the sanitary vent shall be in accordance with Table 82.31-1.

Note: See Appendix for further explanatory material.

3. The vents for a chemical waste basin shall be sized based on the number of drainage fixture units discharging into the basin and installed in accordance with s. Comm 82.31.

History: Cr. Register, February, 1985, No. 350, eff. 3-1-85; am. (4) (a) 2. b., (5) (b) 2. intro., c. and (c) 4. b., Register, August, 1991, No. 428, eff. 9-1-91; am. (4) (a) 2. c. and g., 3. a., (5) (b) 1. f. and j., 3. a., (c) 1., (8) (a) 2. c., r. and recr. (5) (a) 1., r. (5) (b) 3. e. and (c) (intro.), renum. (5) (b) 3. f. to be (5) (b) 3. e., Register, February, 1994, No. 458, eff. 3-1-94; am. (5) (a) 2. (intro.), 3. and (b) 2. (intro.), Register, April, 2000, No. 532, eff. 7-1-00; am. (4) (b) 2., Register, December, 2000, No. 540, eff. 1-1-01; CR 02-002: r. and recr. (1), (2), (4) (a), (8) (a) and (b), am. (3) (intro.), (6) (a) (intro.) and (14) (b) (intro.), renum. (3) (a) to (f) to be (3) (b) to (g), cr. (3) (a) and (14) (b) 3., r. (3) (g), Register April 2003 No. 568, eff. 5-1-03; CR 02-129: am. (4) (a) 2. b. and (5) (b) 1. g., Register January 2004 No. 577, eff. 2-1-04; CR 08-055: am. (3) (a) 1., r. and recr. (4) (b) 2. and (14) (a) 2., renum. (5) (intro.) to (d) to be

(5) (a) to (e) and am. (5) (a) and (b), cr. (5) (c) 7. Register February 2009 No. 638, eff. 3-1-08.

Comm 82.35 Cleanouts. (1) **SCOPE.** The provisions of this section set forth the requirements for the installation of cleanouts and manholes for all drain piping.

(2) **MATERIALS.** Cleanouts shall be constructed of approved materials in accordance with ch. Comm 84.

(3) **WHERE REQUIRED.** (a) *Horizontal drains.* All gravity horizontal drains within or under a building shall be accessible through a cleanout in accordance with one of the following requirements:

1. The developed length of drain piping between cleanouts for above-ground piping may not exceed 75 feet.

2. The developed length of drain piping between cleanouts for below ground piping 2 inches or less in diameter may not exceed 40 feet.

3. The developed length of drain piping between cleanouts for below ground piping greater than 2 inches in diameter may not exceed 75 feet.

Note: See Appendix for further explanatory material.

(b) *Sanitary building sewers.* 1. Sanitary building sewers 6" or less in diameter shall be provided with cleanouts or manholes such that:

a. Cleanouts are located not more than 100 feet apart;

b. Manholes are located not more than 400 feet apart;

c. The distance from a cleanout to a manhole located upstream is not more than 200 feet; or

d. The distance from a manhole to a cleanout located upstream is not more than 300 feet.

2. Sanitary building sewers 8" or larger in diameter shall be provided with manholes at:

a. Every horizontal change in direction of more than 45 degrees where the change in direction is created within a distance of less than 10 feet;

b. Every change in pipe diameters where both connections are 8 inches or larger; and

c. Intervals of not more than 400 feet.

(c) *Storm building sewers.* 1. Storm building sewers 10" or less in diameter shall be provided with cleanouts or manholes such that:

a. Cleanouts are located not more than 100 feet apart;

b. Manholes are located not more than 400 feet apart;

c. The distance from a cleanout to a manhole located upstream is not more than 200 feet; or

d. The distance from a manhole to a cleanout located upstream is not more than 300 feet.

2. Storm building sewers 12" or larger in diameter shall be provided with manholes or storm drain inlets with an inside diameter of at least 36" at:

a. Every horizontal change in direction of more than 45 degrees where the change in direction is created within a distance of less than 10 feet,

b. Every change in pipe diameter where both connections are 12 inches or larger, and

c. Intervals of not more than 400 feet.

(d) *Private interceptor main sewers.* 1. Private interceptor main sewers 5" or less in diameter shall be provided with an exterior cleanout or manhole upstream of the point of the creation of the private interceptor main sewer and such that:

a. Cleanouts are located not more than 100 feet apart;

b. Manholes are located not more than 400 feet apart;

c. The distance from a cleanout to a manhole located upstream is not more than 200 feet; or

d. The distance from a manhole to a cleanout located upstream is not more than 300 feet.

2. Private interceptor main sewers 6" or larger in diameter shall be provided with a manhole at:

a. The most upstream point of the private interceptor main sewer;

b. Every horizontal change in direction of more than 45 degrees where the change in direction is created within a distance of less than 10 feet.

c. Every change in pipe diameter where both connections are 6 inches or larger, and

d. Intervals of not more than 400 feet.

(e) *Junction of building drain and building sewer.* A cleanout shall be provided near the junction of a building drain and a building sewer.

1. The cleanout shall be located within 5 feet of where the building drain and the building sewer connect. The cleanout may be located either inside or outside the building.

2. A cleanout in a drain stack may serve as the cleanout at the junction of the building drain and building sewer, if the stack is within 5 feet of where the building drain and building sewer connect.

(f) *Stacks.* Where a cleanout is provided in a drain stack, the cleanout shall be located 28 to 60 inches above the lowest floor penetrated by the stack.

(g) *Branches.* 1. Except as provided in subd. 2., cleanouts shall be provided in connection with batteries of fixtures at such points that all parts of the branch drain may be accessible for cleaning or removal of stoppages. For the purposes of this requirement, removable fixture traps may serve as cleanout openings.

2. A cleanout shall not be required for a branch drain when the fixtures on the branch include one floor outlet fixture and any fixtures discharging into an accompanying wet vent.

(h) *Greasy wastes.* Drain pipes carrying greasy wastes shall be provided with cleanouts located not more than 40 feet apart and at all changes in direction of more than 45°.

(i) *Double sanitary tees.* A cleanout shall be provided immediately above or below a double sanitary tee drain fitting which is installed in a vertical drain pipe of less than 3" in diameter, unless a stack cleanout is provided in accordance with par. (f).

(j) *Traps and fixture drains.* 1. All traps shall be constructed or installed so that stoppages may be removed from the traps and the horizontal portions of fixture drains.

2. If a trap is not accessible for removal or does not contain a removable dip, a cleanout or a removable inlet shall be installed to enable cleaning of the trap passageway and the horizontal portions of the fixture drain.

(k) *Conductors.* Where a cleanout is provided in a conductor, the cleanout shall be located 28 to 60" above the lowest floor penetrated by the conductor.

(L) *Sampling manholes.* Municipalities or sanitary sewage districts by ordinance or rule may require the installation of sampling manholes for periodic sewage monitoring.

Note: The installation of sampling manholes may be needed for the monitoring of industrial wastes under chs. NR 200 to 299. See Appendix for further explanatory material.

(m) *Catch basins and interceptors.* The fixture drain from all interceptors designed in accordance with s. Comm 82.34 (4) (a) 2. shall be provided with an accessible cleanout located outside of the basin and not more than 15 inches from the weir of the trap.

(4) **DIRECTION OF FLOW.** Every cleanout shall be installed so as to open in the direction of the waste flow or at a right angle thereto.

(5) **ACCESSIBILITY.** Cleanout plugs shall not be covered with cement, plaster, or any other similar permanent finishing material.

(a) *Underground piping.* Cleanouts installed in underground drain piping shall be extended vertically to or above the finish grade.

1. All interior and exterior cleanouts where the vertical distance between the horizontal drain pipe being served and the top of the cleanout opening exceeds 18 inches in length, shall connect to the drain piping through a fitting as specified in Table 82.30-4.

2. A cleanout located outside of a building shall be provided with a frost sleeve.

a. The frost sleeve shall be of a material approved for building sewers in accordance with s. Comm 84.30 (2) (c).

b. Where a cleanout is located in an area subject to vehicular traffic the top of the frost sleeve shall terminate in a concrete pad at least 4" thick and extending at least 9" from the sleeve on all sides, sloping away from the sleeve.

c. The bottom of the frost sleeve shall terminate 6" to 12" above the top of the drain piping or at least 6" below the predicted frost depth in accordance with s. Comm 82.30 Table 82.30-6.

d. The frost sleeve shall have a removable watertight top of sufficient thickness and strength to sustain the weight of anticipated traffic.

Note: See Appendix for further explanatory material.

(b) *Concealed piping.* Cleanout access for drain piping located in concealed spaces shall be provided by either extending the cleanout to at least the surface of a wall or floor or by providing access panels of a sufficient size to permit removal of the cleanout plug and proper cleaning of the pipe.

(6) **CLEANOUT SIZE.** Cleanouts and cleanout extensions shall be sized in accordance with Table 82.35.

Table 82.35
CLEANOUT SIZES

Diameter of Pipe Served by Cleanout (inches)	Minimum Diameter of Cleanout Extension (inches)	Minimum Diameter of Cleanout Opening (inches)
1 ¹ / ₄	1 ¹ / ₄	1 ¹ / ₄
1 ¹ / ₂	1 ¹ / ₂	1 ¹ / ₄
2	1 ¹ / ₂	1 ¹ / ₂
3	3	2 ¹ / ₂
4	4	3 ¹ / ₂
5	5	4
6	6	5
8 and larger	6	6

(7) **PROHIBITED USE OF CLEANOUT OPENINGS.** Cleanout openings shall not be used for the installation of fixtures or floor drains, except where another cleanout of equal access and capacity is provided.

(8) **MANHOLES.** (a) *Diameter.* The minimum diameter of manholes shall be 42". A manhole shall have a minimum access opening of 24".

(b) *Materials.* Manholes shall be constructed of approved materials in accordance with ch. Comm 84 and in accordance with the design provisions of s. NR 110.13.

Note: The provisions of s. NR 110.13 regarding the manhole's flow channel, watertightness, and drop pipe indicate the following specifications:

—The flow channel through manholes shall be made to conform to the shape and slope of the sewer.

—Solid watertight manhole covers are to be used wherever the manhole tops may be flooded by street runoff or high water. Where groundwater conditions are unfavorable, manholes of brick or block shall be waterproofed on the exterior with plastic coatings supplemented by a bituminous waterproof coating or other approved coatings. Inlet and outlet pipes are to be joined to the manhole with a gasketed flexible watertight connection or any watertight connection arrangement that allows differential settlement of the pipe and manhole wall to take place.

—An outside drop pipe is to be provided for a sewer entering a manhole where the invert elevation of the entering sewer is 2 feet or more above the spring line of the outgoing sewer. The entire drop connection shall be encased in the concrete. Inside drop connection may be approved on a case-by-case basis.

Note: See Appendix for further explanatory material.

History: Cr. Register, February, 1985, No. 350, eff. 3-1-85; am. (3) (i), r. and rec. (3) (j), Register, May, 1988, No. 389, eff. 6-1-88; am. (5) (a) 2. a., Register, August,

1991, No. 428, eff. 9-1-91; r. and rec. (3) (j) and (5) (a) 2. c., Register, February, 1994, No. 458, eff. 3-1-94; CR 02-002: am. (3) (a) and (d) 1. (intro.), renum. (3) (g) to be (3) (g) 1. and am., cr. (3) (g) 2. and (m), r. and rec. (5) (a) 1. Register April 2003 No. 568, eff. 5-1-03; CR 08-055: r. and rec. (3) (a), am. (3) (b) 2. a., b., (c) 2. a., b., (d) 2. b., c., (5) (a) 1. and Table 82.35 Register February 2009 No. 638, eff. 3-1-09.

Comm 82.36 Stormwater and clearwater plumbing systems. (1) **SCOPE.** The provisions of this section set forth the requirements for the design, installation and maintenance of piping, conveyance, venting, detention and treatment of stormwater and clearwater in plumbing systems.

Note: Refer to ch. NR 151 for stormwater management requirements.

(2) **MATERIALS.** All stormwater and clearwater plumbing systems shall be constructed of approved materials in accordance with s. Comm 84.30 (3).

(3) **DESIGN OF STORMWATER PLUMBING SYSTEMS.** (a) Plumbing systems upstream of detention shall be designed, at a minimum, based on the 10-year, 24-hour storm event.

(b) Plumbing detention systems and plumbing systems located downstream of detention shall be designed based on anticipated flows and volumes.

(c) Stormwater and clearwater infiltration systems shall comply with s. Comm 82.365.

Note: For a listing of best management practices (BMPs) refer to Appendix A-82.36 (3)-1.

Note: Where local discharge requirements are more stringent, stormwater plumbing systems may provide detention and treatment to comply with the local stormwater management plan.

(4) **DISCHARGE, DISPERSAL, CLEARWATER REUSE OR STORMWATER USE.** (a) *Discharge points.* The discharge points for stormwater and clearwater shall be as specified in Table 82.38-1.

(b) *Segregation of wastewater.* 1. Except as provided in subd. 2., stormwater or clearwater piping may not connect to a sanitary drain system.

2. Where a combined sanitary-storm sewer system is available, stormwater, clearwater and sanitary wastewater may be combined in the building sewer.

3. Stormwater gravity drains shall not be combined with clearwater drains prior to discharging to the storm building drain except where approved by the department.

Note: See also Table 82.38-1 which limits clearwater discharges to sanitary sewer at 50 gpd.

Note: For the use of stormwater or reuse of clearwater, refer to the appropriate requirements in ss. Comm 82.30, 82.34, 82.40, 82.41, 82.70 and this section.

Note: For further explanatory material regarding the rational method, other methods and runoff co-efficients, see Appendix A-82.36 (4).

(5) **INPUT CALCULATIONS.** (a) *Peak flow.* The peak flow of stormwater influent to a plumbing system shall be calculated using any of the following methods:

1. 'Area method.' For sizing of conveyance piping, when calculating stormwater peak flow based on the tributary area, the area in square feet shall be divided by the following applicable divisors:

a. For roofs the divisor is 26 square feet/gpm.

b. For paved or graveled ground surfaces the divisor is 32.5 square feet/gpm.

c. For lawns, parks and similar land surfaces the divisor is 104 square feet/gpm.

Note: For example, 10,000 square feet of roof area/26 square feet/gpm = 385 gpm or 0.85 cubic feet/second.

2. 'Rational method.' For calculating peak flow, the intensity shall be determined using the time of concentration for the tributary area.

Note: For the equation procedure for runoff coefficients for use with the rational method, refer to Appendix A-82.36 (5)-1.

3. 'Engineering analysis method.' An engineering analysis, acceptable to the department, shall be based on the peak flow calculated in accordance with sub. (3) (a).

Note: A model that calculates peak flow such as SWMM, TR-20, TR-55, P8 or an equivalent methodology may be used.

(b) *Volume.* The volume of stormwater influent to a plumbing system shall be based on an engineering design acceptable to the department and a minimum of a two-year, 24-hour storm event

and designed so that no property damage occurs at 100-year, 24-hour storm event with a Type II distribution.

Note: For runoff coefficients and use of other methods or models, refer to Appendix A-82.36 (5)-2 and A-82.36 (5)-3.

Note: The intensity of rainfall varies considerably during a storm as well as geographic regions. To represent various regions of the United States, the U.S. Department of Agriculture (USDA), Natural Resources Conservation Service (NRCS) developed four synthetic 24-hour rainfall distribution types from available National Weather Service (NWS) duration-frequency data (Hershfield 1961; Frederick et al., 1977) or local storm data. Type IA is the least intense and type II is the most intense short duration rainfall. Types I and IA represent the Pacific maritime climate with wet winters and dry summers. Type III represents Gulf of Mexico and Atlantic coastal areas where tropical storms bring large 24-hour rainfall amounts. Type II represents the rest of the country, including Wisconsin. For more information, see the USDA-NRCS webpage: <http://www.nrcs.usda.gov/>.

(c) *Additional inputs to stormwater systems.* Additional inputs to stormwater systems shall be estimated based on anticipated flows and volumes.

(6) CONVEYANCE AND DETENTION SYSTEMS. (a) *Design.* The design of stormwater and clearwater conveyance systems shall conform to all of the following:

1. Horizontal stormwater conveyance piping shall be sized using either of the following:

a. An engineering analysis, based on full flow capacity, acceptable to the department.

b. Tables 82.36-1 to 82.36-5 based on pipe type, diameter and pitch.

Table 82.36-1

MAXIMUM CAPACITY OF STORMWATER CONVEYANCE PIPING FOR PVC, ASTM D1785, D2665, F891 and ABS, ASTM D1527, D2661, F628

Nominal Pipe Size (in inches)	Maximum Capacities in gallons per minute (gpm)					
	Pitch of Piping Per Foot					
	1/32 inch (0.26% slope)	1/16 inch (0.52% slope)	1/8 inch (1.04% slope)	1/4 inch (2.08% slope)	1/2 inch (4.16% slope)	Vertical
3	30	40	60	80	110	89
4	60	80	120	160	230	183
5	110	150	210	300	420	334
6	170	240	340	480	690	545
8	360	510	710	1,010	1,430	1,133
10	660	930	1,310	1,850	2,620	2,079
12	1,050	1,480	2,090	2,960	4,180	3,316
14	1,350	1,900	2,690	3,810	5,390	4,271
16	1,920	2,720	3,840	5,440	7,690	6,097
18	2,630	3,720	5,270	7,440	10,520	8,348
20	3,520	4,970	7,030	9,956	14,060	11,155
24	5,750	8,140	11,490	16,260	22,990	18,244

Note: To convert to cubic feet per second (cfs) divide gpm by 448.8.

Table 82.36-2

MAXIMUM CAPACITY OF STORMWATER HORIZONTAL CONVEYANCE PIPING FOR PVC, ASTM D3034

Nominal Pipe Size (in inches)	Maximum Capacities in gallons per minute (gpm)				
	Pitch of Piping Per Foot				
	1/32 inch (0.26% slope)	1/16 inch (0.52% slope)	1/8 inch (1.04% slope)	1/4 inch (2.08% slope)	1/2 inch (4.16% slope)
4	60	80	110	160	220
6	160	230	320	450	640
8	350	490	700	990	1,400
10	630	900	1,270	1,790	2,540
12	1,010	1,430	2,020	2,850	4,040
15	1,730	2,450	3,460	4,900	6,920

Note: To convert to cubic feet per second (cfs) divide gpm by 448.8.

Table 82.36-3

MAXIMUM CAPACITY OF STORMWATER CONVEYANCE PIPING FOR CAST IRON, ASTM A74 and ASTM A888

Nominal Pipe Size (in inches)	Maximum Capacities in gallons per minute (gpm)					
	Pitch of Piping Per Foot					
	1/32 inch (0.26% slope)	1/16 inch (0.52% slope)	1/8 inch (1.04% slope)	¼ inch (2.08% slope)	½ inch (4.16% slope)	Vertical
3	20	30	40	60	80	80
4	50	60	90	130	180	173
5	80	120	170	230	330	315
6	140	190	270	380	540	516
8	290	420	590	830	1,170	1,118
10	540	770	1,090	1,540	2,170	2,068
12	870	1,230	1,740	2,490	3,490	3,318
15	1,630	2,310	3,270	4,620	6,530	6,217

Note: To convert to cubic feet per second (cfs) divide gpm by 448.8.

Table 82.36-4

MAXIMUM CAPACITY OF STORMWATER HORIZONTAL CONVEYANCE PIPING FOR CONCRETE, ASTM C76 and ASTM C14

Nominal Pipe Size (in inches)	Maximum Capacities in gallons per minute (gpm)				
	Pitch of Piping Per Foot				
	1/32 inch (0.26% slope)	1/16 inch (0.52% slope)	1/8 inch (1.04% slope)	¼ inch (2.08% slope)	½ inch (4.16% slope)
4	40	60	90	120	170
6	130	180	260	360	510
8	280	390	550	780	1,110
10	500	710	1,000	1,420	2,010
12	820	1,150	1,630	2,310	3,260
15	1,480	2,090	2,960	4,180	5,910
18	2,400	3,400	4,810	6,800	9,620
21	3,630	5,130	7,250	10,260	14,500
24	5,180	7,320	10,350	14,640	20,710
27	7,090	10,020	14,170	20,050	28,350
30	9,390	13,270	18,770	26,550	37,550
33	12,100	17,120	24,210	34,230	48,410
36	15,260	21,590	30,530	43,170	61,060
39	18,900	26,720	37,790	53,440	75,580
42	23,020	32,560	46,050	65,120	92,100
48	32,870	46,490	65,740	92,980	131,490
54	45,000	63,640	90,010	127,290	180,010
60	59,600	84,290	119,200	168,580	238,410

Note: To convert to cubic feet per second (cfs) divide gpm by 448.8.

Table 82.36-5
MAXIMUM CAPACITY OF STORMWATER HORIZONTAL CONVEYANCE PIPING FOR ELLIPTICAL REINFORCED CONCRETE PIPE

Pipe Diameters in inches (circular pipe equivalent)	Maximum Capacities in gallons per minute (gpm)			
	Pitch of Piping Per Foot			
	1/16 inch (0.52% slope)	1/8 inch (1.04% slope)	¼ inch (2.08% slope)	½ inch (4.16% slope)
14 X 23 (18)	3,300	4,675	6,700	9,500
19 X 30 (24)	7,200	10,060	14,700	21,000
24 X 38 (30)	13,250	18,740	26,500	37,475
29 X 45 (36)	21,545	30,475	43,095	60,940
34 X 53 (42)	32,500	45,965	65,000	91,925
38 X 60 (48)	46,405	65,625	92,800	131,245
43 X 68 (54)	63,525	89,840	127,050	179,800
48 X 76 (60)	84,135	118,985	168,270	237,965

2. a. A vertical conductor for stormwater may not be smaller than the largest horizontal branch discharging into the conductor.

b. Vertical conductors shall be sized in accordance with Tables 82.36-1 and 82.36-3 or by an engineering analysis acceptable to the department.

Note: For the use of Baird's equation, refer to Appendix A-82.36 (6)-1.

3. Clearwater conveyance systems shall be sized in accordance with s. Comm 82.30 (3) and (4).

4. Underground, gravity-flow storm building sewers shall have a minimum 3-inch inside diameter.

(b) *Velocity in stormwater conveyance system piping.* The pitch of stormwater conveyance system piping shall be designed to create a minimum velocity of one foot per second when flowing full.

(c) *Fittings and connections.* 1. Except as provided in subd. 2., fittings and connections for stormwater and clearwater conveyance systems shall comply with s. Comm 82.30 (8) and (9).

2. The minimum radius for the first 90° fitting located downstream of a roof drain shall comply with the horizontal to vertical requirements in Table 82.30-4.

(d) *Stack offsets.* Stack offsets for piping of a clearwater conveyance system piping shall comply with s. Comm 82.30 (6).

(e) *Pitch of clearwater gravity conveyance system piping.* 1. The minimum pitch of gravity conveyance system piping having a 2-inch inside diameter or less shall be 1/8 inch per foot.

2. The minimum pitch of clearwater gravity conveyance system piping having at least a 3-inch inside diameter or more shall be 1/16 inch per foot.

(f) *Branch connections near base of stack.* Branch drains from interior clearwater inlets may not connect downstream from the base fitting or fittings of a drain stack within a distance equal to 20 pipe diameters of the building drain.

(g) *Detention systems.* 1. The storage volume of a dry detention system shall be designed and installed with a drain time of 72 hours after a storm event.

2. Paved surfaces or parking lots serving as detention areas shall be limited to a design depth of 6 inches, unless otherwise limited by local ordinance.

3. By design, ground surface ponding shall drain within 24 hours after a storm event.

(7) OTHER DESIGN REQUIREMENTS. (a) *Subsoil drains.* 1. A subsoil drain discharging to a plumbing system shall discharge into an area drain, manhole or storm sewer, trapped receptor or a sump with a pump.

2. Where a foundation drain is subject to backwater, the drain shall be protected by a backwater valve or a sump with a pump.

(b) *Backwater valve.* All backwater valves shall be accessible for maintenance.

(c) *Sewer location.* 1. No storm building sewer or private interceptor main storm sewer may pass through or under a building to serve another building, unless one of the following conditions is met:

a. The storm building sewer or private interceptor main storm sewer serves farm buildings or farm houses, or both, that are located on one property.

b. Where a storm building sewer or private interceptor main storm sewer serves buildings that are located on one property, a document that indicates the piping and distribution arrangement for the property and buildings is recorded with the register of deeds no later than 90 days after installation.

2. The location of storm building drains and building sewers shall comply with ss. Comm 82.30 (11) (d) and 82.40 (8) (b) 7.

(d) *Installation requirements.* 1. The connection of a stormwater leader discharging to a storm building sewer shall be made above the finished grade.

Note: For more information regarding joints and connections, refer to s. Comm 84.40.

2. The elevation of a storm building drain shall comply with s. Comm 82.30 (11) (b) 1.

3. Interior inlets and drains subject to backflow or backwater shall be protected with a check valve or backwater valve.

4. Storm building drains and building sewers shall be installed to comply with s. Comm 82.30 (11) (e).

5. Storm building sewer connections to public sewers shall be in accordance with s. Comm 82.30 (11) (f).

6. Cleanouts for conveyance system piping shall be installed in accordance with s. Comm 82.35.

7. Storm building sewers that receive clearwater and that may be subject to freezing shall be installed in accordance with s. Comm 82.30 (11) (c) 2.

8. Storm building drains, clearwater building drains, and building storm sewers and appurtenances shall be separated from water wells by the applicable separation distances contained in chs. NR 811 and 812, or as otherwise permitted by the department of natural resources.

9. All underground stormwater storage tanks for water reuse shall be separated from sanitary sewers by a minimum of 8 feet.

10. a. A means to locate buried non-metallic storm building sewers and private interceptor main sewers that discharge to municipal mains shall be provided in accordance with the options under s. Comm 82.30 (11) (h), except as provided in subd. 10. b.

b. Tracer wire insulation color for non-metallic storm pipe shall be brown.

(8) SUMPS AND PUMPS. (a) *Sumps.* 1. 'General.' All storm building subdrains shall discharge into a sump, the contents of which shall be automatically lifted and discharged, dispersed or used in accordance with sub. (4).

2. 'Construction and installation'. a. Except as provided in subd. 2. c. and d., an interior sump shall have a rim extending at least one inch above the floor immediately adjacent to the sump.

b. A sump shall have a removable cover of sufficient strength for anticipated loads.

c. Where a sump is installed in an exterior meter pit or elevator pit, the rim may be level with the floor.

d. When a sump is provided with an airtight, solid cover.

3. 'Location'. All sumps installed for the purpose of receiving clearwater, groundwater or stormwater shall be separated from water wells by the applicable separation distances contained in chs. NR 811 and 812, or as otherwise permitted by the department of natural resources.

Note: See Appendix A-82.30 (11) (d) for material reprinted from s. NR 812.08.

4. 'Size'. a. Except as permitted under subd. 4. b. or c. the size of each sump shall be no smaller than 16 inches in diameter at the top, 14 inches in diameter at the bottom, and 22 inches in depth.

b. The minimum sump diameter may be smaller than 16 inches when specified by the manufacturer for a combination sump and pump.

c. A sump located in an elevator pit may have a width or diameter of not less than 12 inches and a depth of not less than 12 inches.

(b) *Pumps.* 1. 'Size.' The pump shall be of a capacity appropriate for the anticipated use.

2. 'Discharge piping'. a. Where a pump discharges into a storm drain system, a check valve shall be installed.

b. The minimum diameter discharge piping shall be based on the design flow rate of the pump and a minimum velocity of one foot/second.

(9) INLET REQUIREMENTS. (a) *Interior clearwater drain inlets.* Interior clearwater drain inlets shall terminate at least one inch above the finished floor.

(b) *Exterior stormwater inlets.* 1. 'Construction.' a. All exterior stormwater inlets shall be constructed of material in accordance with s. Comm 84.30.

Note: For additional information on approved materials, refer to s. Comm 84.30 (f).

b. All exterior stormwater inlets subject to vehicular traffic shall be set on a suitable base capable of sustaining the anticipated load.

2. 'Design'. All exterior stormwater inlets shall be designed for the anticipated flow.

Note: For manhole requirements, refer to s. Comm 82.35 (3).

3. 'Inlet grates'. a. General. All inlets shall be provided with a well-fitted, removable grate of a thickness and strength to sustain the anticipated loads.

Note: Sections Comm 62.1101 to 62.1110 specify that for floor or ground surface inlets when placed within an identifiable accessible route, openings in the floor or ground surface shall be of a size that does not permit the passage of a ½-inch sphere. Also, it states that grates having elongated openings be placed so that the longest dimension is perpendicular to the dominant direction of travel.

b. Floor or ground surface inlets. Openings in the floor or ground surface shall be of a size that prohibits the entrapment of wheeled vehicles, wheelchairs or pedestrians within the grate openings.

c. Grates on horizontal pipes. Grates shall be provided on horizontal inlets greater than 6 inches in diameter. The grates shall be placed so that the rods or bars are not more than 3 inches downstream of the inlet. Rods or bars shall be spaced so that the openings do not permit the passage of a 6-inch sphere.

Note: See Appendix for further explanatory material.

(c) *Subsurface areas of 50 square feet or less.* Other than stairwells, all subsurface areas not exceeding 50 square feet and exposed to the weather, shall comply with one of the following:

1. Drain to foundation drains through a minimum 2-inch diameter pipe or a through a continuous layer of washed stone aggregate.

2. Drain to the storm building drain, storm subdrain or storm sewer through a minimum 3-inch diameter pipe.

(d) *Subsurface areas of more than 50 square feet and stairwells.* An area drain shall be provided in subsurface areas greater than 50 square feet and in all stairwells exposed to the weather. The area drain shall comply with all of the following:

1. Drain to the storm building drain, storm subdrain or storm sewer.

2. The fixture drain shall have a minimum 3-inch inside diameter and may not discharge into a subsoil or foundation drain.

(10) ROOF DRAINS. (a) *General roofs.* Roof drains shall be equipped with strainers extending not less than 4 inches above the surface of the roof immediately adjacent to the roof drain. Strainers shall have an available inlet area above the roof of not less than 1.5 times the area of the conductor to which the drain connects.

(b) *Flat decks.* Roof drain strainers used on sun decks, open parking decks and similar areas shall be of the flat surface type, shall be level with the deck and shall have an available inlet area of not less than 2 times the area of the conductor to which the drain connects.

(11) SECONDARY ROOF DRAINS. (a) *Sizing.* When secondary roof drain systems are installed the secondary system shall be sized and installed in accordance with the requirements in this section.

(b) *Prohibited connection.* Secondary roof drain systems may not be connected to primary roof drain systems.

(c) *Discharge.* All secondary roof drain systems shall discharge in accordance with Table 82.38-1.

(12) TRAPS AND VENTS. (a) *Traps.* 1. Traps are required for interior drain inlets receiving clearwater.

2. Except for exterior loading dock drains, traps are required for exterior drain inlets located within 10 feet of an air inlet, door or openable window.

3. More than one drain inlet may discharge to the same trap.

4. A foundation drain that discharges by gravity to a storm sewer shall be trapped. The trap shall be provided with cleanouts.

(b) *Vents.* 1. A trap receiving clearwater shall be vented in accordance with s. Comm 82.31. Vent piping for a clearwater drain system may not be connected to a vent system serving a sanitary drain system or chemical waste system.

2. a. Vents serving a solid covered sump shall terminate a minimum of one inch above finished floor.

b. Sump vents shall be sized as per Table 82.31-4.

(13) OPERATION AND MAINTENANCE. (a) *Plan.* An operation and maintenance plan shall be implemented for all stormwater plumbing systems for drainage areas of one or more acres that are installed on or after December 1, 2004.

(b) *Plan information.* An operation and maintenance plan as required in par. (a) shall include at least all of the following information, applicable to the system:

1. Accumulated solids or byproduct removal requirements.
2. Identification of safety hazards.
3. Cleaning and inspection schedule.
4. Inspection and maintenance checklist, including at least the following items:

- a. Filters.
- b. Disinfection units.
- c. Sedimentation chambers.
- d. Detention devices.

- e. Infiltration systems.
5. Start up and shutdown procedures.
6. Vector control requirements.
7. A contingency plan in the event of system failure.

(c) *Plan location.* The operation and maintenance plan shall remain onsite and be available for inspection when requested by the department.

(d) *Record of maintenance.* When requested the owner shall make available for inspection all maintenance records to the department or agent for the life of the system.

History: Cr. Register, February, 1985, No. 350, eff. 3-1-85; r. and recr. (3) (a) and (b) 1., (c) 1. and (11) (a) 4., cr. (3) (c) 3., Register, May, 1988, No. 389, eff. 6-1-88; renum. (13) (a) and (b) to be (b) and (c) and am. (b) 1., cr. (3) (b) 3. and (13) (a), r. (3) (c) 3. and (13) (intro.), Register, August, 1991, No. 428, eff. 9-1-91; reprinted to correct error in (5) (e) 2., Register, October, 1991, No. 430; am. (3) (b) 1., (c) 1. a., (13) (b) 1. and (c), cr. (11) (a) 5., Register, February, 1994, No. 458, eff. 3-1-94; r. and recr. (11) (a) 2. and 5., Register, April, 1998, No. 508, eff. 5-1-98; renum. and am. (3) (b) 3. a. to be (3) (b) 3. and (3) (b) 3. b. to be (3) (b) 4., Register, April, 2000, No. 532, eff. 7-1-00; am. (3) (b) 3., (4) (a), (5) (a) and (6) (a), cr. (3) (b) 5. and Table 82.36-4a, Register, December, 2000, No. 540, eff. 1-1-01; CR 02-002: r. and recr. (3), (11) (a) 3., (13) (a) 2., (15) (a) and (b), am. (5) (e) (intro.), (10), (12), (14) and Table 82.36-4 Register April 2003 No. 568, eff. 5-1-03; CR 04-035: r. and recr. Register November 2004 No. 587, eff. 12-1-04; CR 07-069: cr. (7) (d) 10. Register February 2008 No. 626, eff. 3-1-08; CR 08-055: am. (4) (b) 3. and (8) (a) 4., r. and recr. (11) Register February 2009 No. 638, eff. 3-1-09.

Comm 82.365 Stormwater and clearwater subsurface infiltration plumbing systems. (1) SCOPE. The provisions of this section set forth the requirements for the design, installation and maintenance of stormwater and clearwater subsurface infiltration plumbing systems serving building sites.

Note: The department of natural resources has registration requirements for class V injection wells. See Appendix for further explanatory material.

(2) **SITE AND SOIL EVALUATION.** (a) *Site evaluation.* A site evaluation shall be conducted in accordance with the methods and standards as provided in s. Comm 85.40 (3) (a).

(b) *Soil evaluation.* 1. A soil evaluation shall be conducted in accordance with the methods and standards as provided in s. Comm 85.30 (1) (c).

2. Individuals qualified to conduct soil evaluation under this subsection shall be an individual that maintains either a registration as provided in s. Comm 5.33 or a license as provided in ch. GHSS 4.

(3) **INFILTRATION SYSTEM DESIGN.** (a) *Influent quality.* For stormwater and clearwater infiltration plumbing systems, the influent quality shall comply with the requirements in Table 82.70-1 for subsurface infiltration and irrigation.

(b) *In situ soil requirements.* 1. Except as provided in subd. 2., the minimum depth of suitable in situ soil for infiltration systems shall be as specified in Table 82.365-1 to separate the system from the highest groundwater elevation or bedrock. When groundwater mounding calculations affect the depth to seasonal groundwater, the depth of suitable soil shall be measured to the calculated elevation of mounded groundwater.

2. For roof runoff or where treatment has afforded an equivalent level of water quality, the depth of in situ soil shall be no less than one foot of materials finer than coarse sand.

Note: See Appendix for representative water quality levels.

**Table 82.365-1
DEPTH OF SUITABLE SOILS BY USDA SOIL TEXTURE AND PERCENT FINES OF THE
INFILTRATIVE SURFACE**

Soil Texture	Minimum 5 ft. of Suitable Soil Separation and $\geq 10\%$ but $< 20\%$ Fines ^a		Minimum 3 ft. of Suitable Soil Separation and $\geq 20\%$ Fines ^a	
	Texture Suitability	Maximum Rock Fragment Content ^b	Texture Suitability	Maximum Rock Fragment Content ^b
Sands				
COS	NP ^c	---	NP	---
S	NP ^c	---	NP ^c	---
FS	NP ^c	---	NP ^c	---
VFS	X	NP ^c > 60%	X	NP ^c > 20%
Loamy sands				
LCOS	X	NP ^c > 0%	NP ^c	---
LS	X	NP ^c > 0%	NP ^c	---
LFS	X	NP ^c > 0%	NP ^c	---
LVFS	X	NP ^c > 82%	X	NP ^c > 63%
Sandy loams				
COSL	X	NP ^c > 56%	X	NP ^c > 13%
SL	X	NP ^c > 56%	X	NP ^c > 13%
FSL	X	NP ^c > 56%	X	NP ^c > 13%
VFSL	X	NP ^c > 74%	X	NP ^c > 47%
Loam (L)	X	NP ^c > 79%	X	NP ^c > 58%
Silt Loam (SIL)	X	NP ^c > 84%	X	NP ^c > 68%
Silt (SI)	X	NP ^c > 88%	X	NP ^c > 75%
Clay Loams				
SCL	X	NP ^c > 71%	X	NP ^c > 43%
SICL	X	NP ^c > 88%	X	NP ^c > 75%
CL	X	NP ^c > 81%	X	NP ^c > 63%
Clays				
SC	X	NP ^c > 78%	X	NP ^c > 56%
SIC	X	NP ^c > 88%	X	NP ^c > 75%
C	X	NP ^c > 82%	X	NP ^c > 63%

NP = Not permitted.

X = Suitable for use under the specified conditions.

^a Fines are mineral particles passing a 200 mesh sieve (less than 0.075mm). Content is measured by weight.

^b Rock fragments are unattached pieces of rock 2 mm in diameter or larger. Content is measured by volume.

^c Permitted only where laboratory analysis provides evidence of percent fines required.

USDA Soil Texture Abbreviations:

COS = Coarse Sand
 LS = Loamy Sand
 COSL = Coarse Sandy Loam
 VFSL = Very Fine Sandy Loam
 SI = Silt
 CL = Clay Loam
 C = Clay

S = Sand
 LFS = Loamy Fine Sand
 SL = Sandy Loam
 L = Loam
 SCL = Sandy Clay Loam
 SC = Sandy Clay

LCOS = Loamy Coarse Sand
 LVFS = Loamy Very Fine Sand
 FSL = Fine Sandy Loam
 SIL = Silt Loam
 SICL = Silty Clay Loam
 SIC = Silty Clay

(c) *Hydraulic application rates.* The maximum hydraulic application rate for stormwater and clearwater subsurface infiltration plumbing systems shall be in accordance with one of the following methods.

1. The maximum hydraulic application rate shall be determined by soil analysis in accordance with sub. (2) (b) and Table 82.365-2.

2. The maximum hydraulic application rate shall be determined by field measurement using a nationally-accepted method and the correction factor as determined using Table 82.365-3. To determine the maximum hydraulic application rate, the measured infiltration rate at the infiltrative surface shall be divided by the correction factor as listed in Table 82.365-3.

**Table 82.365-2
 DESIGN INFILTRATION RATES FOR SOIL TEXTURES RECEIVING STORMWATER**

Soil Texture ^a	Design Infiltration Rate Without Measurement inches/hour ^b
Coarse sand or coarser	3.60
Loamy coarse sand	3.60
Sand	3.60
Loamy sand	1.63
Sandy loam	0.50
Loam	0.24
Silt loam	0.13
Sandy clay loam	0.11
Clay loam	0.03
Silty clay loam	0.04 ^c
Sandy clay	0.04
Silty clay	0.07
Clay	0.07

^a Use sandy loam design infiltration rates for fine sand, loamy fine sand, very fine sand, and loamy fine sand soil textures.

^b Infiltration rates represent the lowest value for each textural class presented; based on Rawls et al., 1998 [Use of Soil Texture, Bulk Density and Slope of Water Retention Curve to Predict Saturated Hydraulic Conductivity, ASAE, Vol. 41(2), pp. 983-988].

^c Infiltration rate is an average, based on Rawls et al., 1982 (Estimation of Soil Water Properties, Transactions of the American Society of Agricultural Engineers Vol. 25, No. 5 pp. 1316-1320 and 1328) and Clapp & Hornberger, 1978 (Empirical equations for some hydraulic properties. Water Resources Research 14:601-604).

**Table 82.365-3
 TOTAL CORRECTION FACTORS DIVIDED INTO MEASURED INFILTRATION RATES**

Ratio of Design Infiltration Rates ^a	Correction Factor
1	2.5
1.1 to 4.0	3.5
4.1 to 8.0	4.5
8.1 to 16.0	6.5
16.1 or greater	8.5

^a Ratio is determined by dividing the design infiltration rate from Table 82.365-2 for the textural classification at the bottom of the infiltration device by the design infiltration rate from Table 82.365-3 for the textural classification of the least permeable soil horizon. The least permeable soil horizon used for the ratio should be within five feet of the bottom of the device or to the depth of the limiting layer.

(d) *Groundwater mounding.* Groundwater mounding consideration shall be included in the design of any stormwater and clearwater subsurface infiltration plumbing system that has a width that exceeds 15 feet and a depth to the estimated highest groundwater elevation.

Note: An acceptable model is provided by the USGS, webpage: <http://water.usgs.gov/ogw/techniques.html>.

(e) *Drain down time.* 1. Stormwater and clearwater subsurface infiltration plumbing systems shall be designed to drain within 72 hours after a storm event.

2. By design, ground surface ponding shall drain within 24 hours after a storm event.

(f) *Setbacks.* 1. Stormwater and clearwater subsurface infiltration plumbing systems shall be located as provided in Table 82.365-4, except for irrigation systems.

**Table 82.365-4
 HORIZONTAL SETBACK PARAMETERS
 BY PHYSICAL FEATURE**

Physical Feature	Setback Parameters in feet
Building	10
Holding tank, stormwater collection tank	10
POWTS dispersal component	5
POWTS holding or treatment component	10
Property line	5
Swimming pool, in ground	15

2. All stormwater and clearwater subsurface infiltration plumbing systems shall be separated from water wells by the applicable separation distances contained in chs. NR 811 and 812 or as otherwise approved by the department of natural resources.

Note: See Appendix A-82.30 (11) (d) for material reprinted from ss. NR 811.16 (4) (d) and 812.08. Section NR 811.16 (4) (d) or 812.08 may have additional setback requirements.

(4) *INSTALLATION.* (a) *Orientation.* Except for subsurface irrigation systems, all of the following shall apply:

1. The longest dimension of a stormwater or clearwater subsurface infiltration plumbing system consisting in part of in situ soil shall be oriented along the surface contour of the site location, unless otherwise approved by the department.

2. The infiltrative surface of a stormwater or clearwater subsurface infiltration plumbing system consisting in part of in situ soil and located below the surface of the original grade shall be level.

(b) *Other requirements.* 1. A stormwater or clearwater subsurface infiltration plumbing system consisting in part of in situ soil may not be installed if the soil is frozen at the infiltrative surface.

2. Snow cover shall be removed before excavating or installing a stormwater or clearwater system component consisting in part of in situ soil.

3. For a stormwater or clearwater subsurface infiltration plumbing system consisting in part of in situ soil, the soil moisture content shall be evaluated immediately prior to installation of the component. If the soil evaluation at the infiltrative surface results in the sample capable of being rolled into a ¼ -inch wire, the installation may not proceed.

Note: To accomplish a field test for soil wetness, a soil sample the size of one's palm may be rolled to form at least a ¼ -inch wire.

4. All vessels and pipes of a stormwater or clearwater subsurface infiltration plumbing system shall be bedded in accordance with a product approval under s. Comm 84.10 or a plan approval under s. Comm 82.20.

(5) *OPERATION AND MAINTENANCE.* (a) *General.* Operation and maintenance shall be performed in accordance with the opera-

tion and maintenance plan submitted with the stormwater and clearwater subsurface infiltration plumbing system design and s. Comm 82.36 (13), where applicable.

(b) *Prohibited substance*. 1. Except as provided in subd. 2., no substance shall be discharged into a stormwater or clearwater subsurface infiltration plumbing system that results in exceeding the enforcement standards and preventive action limits specified in ch. NR 140 Tables 1 and 2 at a point of standards application, pursuant to s. 160.21 (2), Stats.

Note: For groundwater standard limits on various substances, refer to ch. NR 140 Table 1.

2. Pursuant to s. 160.19 (2) (a), Stats., the department has determined that it is not technically or economically feasible to require that a stormwater or clearwater subsurface infiltration plumbing system treat wastewater to comply with the preventive action limit for chloride specified in ch. NR 140 Table 2, as existed on June 1, 1998.

Note: Section 160.19 (2) (a), Stats., reads: "Each regulatory agency shall promulgate rules which define design and management practice criteria for facilities, activities and practices affecting groundwater which are designed, to the extent technically and economically feasible, to minimize the level of substances in groundwater and to maintain compliance by these facilities, activities and practices with preventive action limits, unless compliance with the preventive action limits is not technically and economically feasible."

3. Pursuant to s. 160.21 (2), Stats., the point of standards application relative to the performance of stormwater and clearwater subsurface infiltration plumbing systems is any of the following:

a. Any point of present groundwater use for potable water supply.

b. Any point beyond the boundary of the property on which the facility, practice or activity is located.

(c) *Deleterious substance*. Substances deleterious to a stormwater or clearwater subsurface infiltration plumbing system shall be intercepted, diluted or treated in accordance with s. Comm 82.34 prior to the substance discharging into a stormwater or clearwater infiltration system.

History: CR 04-035: cr. Register November 2004 No. 587, eff. 12-1-04.

Comm 82.37 Sanitation facilities and campgrounds. (1) **COMPOSTING SYSTEMS.** (a) Composting systems which employ water or other liquids as a transport medium for wastes shall conform with this subsection.

Note: Composting systems where water or other liquids are not employed as a transport medium are addressed under ch. Comm 91.

(b) The materials, design, construction and performance of a composting system which employs water or other liquids as a transport medium for wastes shall conform to NSF Standard 41.

(c) All composting systems shall be listed by a testing agency acceptable to the department.

Note: For a listing of agencies acceptable to the department, see Appendix A-34.11.

(d) 1. Components for the storage or treatment of wastes shall be continuously ventilated.

2. Ventilation ducts or vents for the composting system shall conform to s. Comm 82.31 (16).

(e) 1. The disposal of the end product from a composting system shall be in accordance with 40 CFR Part 503, Standards for the Use or Disposal of Sewage Sludge.

Note: EPA materials relating to EPA 503, including, "Domestic Septage Regulatory Guidance: A Guide to the EPA 503 Rule", are available from the Office of Water Resource, US EPA, 401 M Street SW, Washington D.C. 20460.

2. The disposal of any liquid from a composting system shall be either to a publicly owned treatment works or a POWTS conforming to ch. Comm 83.

(f) The connection of potable water supplies to a composting system shall be protected in accordance with s. Comm 82.41.

(g) The drainage systems for the composting system shall conform to the applicable requirements of ss. Comm 82.30 to 82.36 and the manufacturer's specifications.

(2) **SANITARY DUMP STATIONS.** (a) Sanitary dump stations which are used to receive domestic wastes and domestic wastewater from the holding tanks of travel trailers, recreational vehicles or other similar mobile vehicles, and transfer containers shall conform with this subsection.

Note: See Appendix A-82.37 (2) for further explanatory material.

(b) The drain receptor for a sanitary dump station shall be at least 4" in diameter.

(c) 1. The drain receptor shall be provided with a self-closing cover.

2. The cover for the drain receptor shall be operable without touching the cover with one's hands.

(d) The drain receptor shall be surrounded by an impervious pad at least 6 feet in diameter. The pad shall be:

1. Pitched toward the drain receptor with a minimum slope of 1/4" per foot; and

2. Of sufficient strength to sustain anticipated loads.

(e) The drain receptor shall be trapped in accordance with s. Comm 82.32.

(f) The drain receptor for a sanitary dump station that is installed within an enclosed structure shall be vented in accordance with s. Comm 82.31.

(g) A supply of water shall be provided to wash down the drain receptor and pad. The water supply shall be:

1. Provided with cross connection control in accordance with s. Comm 82.41; and

2. Labeled indicating that the supply is not for drinking purposes.

(h) 1. Aboveground drains shall be constructed of approved materials in accordance with s. Comm 84.30 (2) (a).

2. Aboveground water supply piping shall be constructed of approved materials in accordance with s. Comm 84.30 (4) (e).

(3) **CAMPGROUNDS.** (a) *Drain systems.* Sewers serving campgrounds shall comply with the provisions in s. Comm 82.30 and all of the following:

1. A drain line serving a recreational vehicle shall discharge to a minimum 4-inch diameter campsite receptor by means of an indirect waste pipe.

2. One campsite receptor shall be designed to serve no more than 4 recreational vehicles.

3. Where 2 or more drain lines are designed to discharge into the same campsite receptor, an increaser shall be installed in the vertical portion of the trap riser to accommodate the drains.

4. The rim of a campsite receptor shall terminate no less than 4 inches above the finished grade.

5. The rim of a campsite receptor shall not terminate at an elevation that is higher than the water supply termination serving the same site.

6. A vent is not required to serve the trap serving a campsite receptor.

7. When not in use, a campsite receptor shall be capped.

(b) *Water supply systems.* Water supply systems serving campgrounds shall comply with the provisions in s. Comm 82.40 and all of the following:

1. An accessible control valve shall be installed at the most upstream point of the campground water supply distribution system and downstream of the municipal meter or pressure tank.

2. If water is provided to a campsite, individual approved backflow protection shall serve each hose connection in accordance with s. Comm 82.41.

3. A campsite water supply riser shall terminate no less than 18 inches above finished grade.

Note: See Appendix for further explanatory material.

History: Cr. Register, April, 2000, No. 532, eff. 7-1-00; CR 02-002: cr. (2) (h) and (3) Register April 2003 No. 568, eff. 5-1-03; CR 08-055: am. (3) (b) 3. Register February 2009 No. 638, eff. 3-1-09.

Comm 82.38 Discharge points. (1) PURPOSE. The purpose of this section is to establish allowable discharge points for wastewater discharging from plumbing systems.

(2) SCOPE. The provisions of this section set forth the requirements for the discharge points for wastewater based on the use of the fixtures, appurtenances, appliances and devices discharging

into the plumbing system.

(3) GENERAL REQUIREMENTS. (a) Wastewater from plumbing systems shall be discharged as specified in Table 82.38-1.

(b) Wastewater from uses other than those listed in Table 82.38-1, shall be discharged as specified by the department on a site-specific basis.

Table 82.38 - 1

ALLOWABLE DISCHARGE POINTS BY FIXTURE OR SPECIFIC USES

Use or Fixture	Allowable Discharge Points					
	POWTS ^a	Municipal Sanitary Sewer	Municipal Storm Sewer	Ground Surface	Combined Sanitary-Storm Sewer	Subsurface Dispersal ⁱ
1. Cross connection control device or assembly [see s. Comm 82.33 (9) (i)]	X	X		X ^{b, c, e}	X	
2. Domestic wastewater	X	X			X	
3. Condensate from high efficiency furnace or water heater	X	X			X	
4. Drinking fountain	X	X	X	X ^b	X	X
5. Elevator pit drain [see s. Comm 82.33 (9) (f)]			X	X ^b	X	X
6. Enclosed public parking levels	X	X		X ^b	X	X
7. Industrial wastewater ^h	X ^f	X			X	
8. Municipal well pump house floor drain and sink	X	X		X ^b	X	X
9. One- and 2-family garage floor area [see s. Comm 82.34 (4) (b)]	X	X		X ^b	X	
10. Residential living unit air conditioner condensate	X	X ^g	X ^c	X ^b	X	X
11. Storm water, groundwater, fire sprinkler test discharge and clear water	X	X ^g	X ^c	X ^b	X	X
12. Secondary roof drain systems				X ^j		
13. Swimming pool or wading pool — diatomaceous earth filter backwash	X	X			X	
14. Swimming pool or wading pool — drain wastewater	X	X ^b	X ^{b, c}	X ^{b, c}	X ^b	X
15. Swimming pool or wading pool — sand filter backwash	X	X ^b	X ^{b, c}	X ^{b, c}	X ^b	X
16. Water heater temperature and pressure relief valve [see s. Comm 82.40 (5)]	X	X	X	X ^b	X	X
17. Wastewater from water treatment device	X	X	X ^c	X ^{b, c}	X	X
18. Whirlpool backwash drain and wastewater	X	X	X ^c	X ^{b, c}	X	
19. Discharges not specifically listed above	Contact the department					

^a Allowed when the POWTS is designed to include designated wastewater.

^b Unless prohibited by local municipality and when no nuisance is created.

^c A discharge permit may be required by the department of natural resources.

^e Allowed for exterior installation and when no sanitary sewer is in the building.

^f Refer to the department of natural resources for discharge regulations.

^g Fifty gallons per day.

^h The department of natural resources may require WPDES permits for industrial discharges and may allow other options.

ⁱ Subsurface dispersal must comply with s. Comm 82.365.

^j Discharge separate from the primary system and where observable.

History: CR 02-002: cr. Register April 2003 No. 568, eff. 5-1-03; CR 02-129: am. Table 82.38-1 line 15 Register January 2004 No. 577, eff. 2-1-04; CR 04-035: am. Table 82.38-1 Register November 2004 No. 587, eff. 12-1-04; CR 08-055: am. Table 82.38-1 Register February 2009 No. 638, eff. 3-1-09.

Subchapter IV — Water Supply Systems

Comm 82.40 Water supply systems. (1) SCOPE. The provisions of this section set forth the requirements for the design and installation of water supply systems.

Note: Chapter NR 811 governs the design and construction of community water systems or waterworks.

(2) MATERIALS. All water supply systems shall be constructed of approved materials in accordance with ch. Comm 84.

(3) GENERAL. (a) Potable water required. 1. Every outlet providing water shall be provided with water of the quality as specified under s. Comm 82.70 (3) for the intended use.

2. Nonpotable water may be supplied to water treatment devices or systems designed to treat water for compliance with Table 82.70-1.

(b) Hot water required. Except as provided in subds. 1. and 2., hot water shall be provided to all plumbing fixtures, appliances and equipment used for personal washing, culinary purposes or laundering.

1. Tempered water. a. Tempered water or hot water shall be provided to lavatories, wash fountains and shower heads which are not located in dwelling units or living units.

b. Tempered water supplied to serve multiple lavatories, wash fountains and shower heads shall be provided by means of temperature-actuated mixing valves that comply with ASSE 1017.

2. Lavatories located in park shelters and bath houses which are not open during the period from November 15 to March 15 and which are not places of employment shall not be required to be provided with hot water.

3. Lavatories located in waysides which are not places of employment shall not be required to be provided with hot water.

Note: The exception of providing hot water under subds. 1. to 3. does not supercede the requirements of other state agencies for providing hot water.

(c) Protection. 1. Pursuant to s. NR 811.09 (2) the interconnection of 2 or more water supply systems, one system served by a public supply source and the other system served by another supply source is prohibited, unless approved in writing by the department of natural resources.

2. A water supply system shall be designed and installed in accordance with s. Comm 82.41 and maintained to prevent nonpotable liquids, solids or gases from being introduced into the potable water supply system through cross connections.

3. a. Except as provided in subd. 3. b., when a connection between 2 water supply systems exists, one system having a higher degree of hazard than the other system as specified in s. Comm 82.41, the water supply system with a lower degree of hazard shall be protected as specified in s. Comm 82.41.

b. When a water treatment device is provided to lower the concentration of a health-related contaminant, cross connection control shall not be required to protect the water supply system downstream of the treatment device from the upstream contaminated source.

(d) Identification. 1. Where buildings or facilities contain water supply systems where the water supply systems have different degrees of hazard, all water supply systems shall be labeled in accordance with this section.

a. All aboveground piping supplying nonpotable water shall be labeled by tags or yellow bands. The yellow bands shall be at least 3 inches wide and shall bear text identifying the water and the specific use or uses.

b. The tags or colored bands shall be placed at intervals of not more than 25 feet. Where piping passes through a wall, the piping shall be so identified on each side of the wall and within each compartment.

c. The tags or colored bands identifying nonpotable water and potable water piping shall be placed at intervals of not more than 25 feet and at each side where the piping passes through a wall, floor or roof.

d. All valves and outlets supplying nonpotable water shall be identified nonpotable by tags.

e. All valves, except fixture stop valves, supplying potable water shall be identified potable by tags.

f. Tags used to identify nonpotable water outlets, valves and piping shall be of metal or plastic in the shape of an equilateral triangle with 4 inch sides and bearing the legend "water unsafe" or other similar wording approved in writing by the department. The lettering on the tags shall be raised or indented and at least 1/2" in height.

g. Tags used to identify potable water valves shall be of metal or plastic in the shape of a 3-inch diameter circle bearing the legend "safe water" or other similar wording approved in writing by the department. The lettering on the tags shall be raised or indented and at least 1/2" in height.

h. A hose bibb intended to discharge water that does not meet drinking water quality as specified in s. Comm 82.70, shall be labeled as nonpotable or so identified for the specific use or uses, and shall be equipped with a removable key handle.

2. Where a building or a structure is served by 2 distribution systems, one system supplied by a public water supply and the other system supplied by a private well, each water distribution system shall be identified to indicate the supply source.

3. The installation of each reduced pressure principle backflow preventer, reduced pressure fire protection principle backflow preventer, reduced pressure detector fire protection backflow preventer, spill resistant vacuum breaker and pressure vacuum breaker shall display a department assigned identification number.

a. The method to display the department assigned identification number shall be a weather-resistant tag, securely attached to the cross connection control assembly.

b. The tag shall contain at least the following information.

<p style="text-align: center;">Wisconsin Department of Commerce Identification/Object Number _____ Cross Connection Control Assembly Do Not Remove This Tag</p>
--

c. The department assigned identification number shall be printed in the blank area with a permanent, waterproof marker or similar indelible method.

Note: To obtain a department assigned identification number for a cross connection control assembly contact the department at the Safety and Buildings Division; P.O. Box 7302; Madison, Wisconsin 53707-7302; telephone (608) 266-0521; Fax (608) 267-0592; TTY (608) 264-8777.

(e) Multipurpose piping system. 1. Except as provided in subd. 2., a multipurpose piping system shall be designed and installed in accordance with this section and NFPA 13D.

Note: Pursuant to this subdivision and sub. (2), materials for multipurpose piping systems need to be acceptable under the NFPA 13D standard and s. Comm 84.30, Table 84.30-9.

2. a. Fire department connections are prohibited in a multipurpose piping system.

b. Sections 7.6, 6.3(4), 8.1.3 and 8.6 of NFPA 13D do not apply in Wisconsin.

c. A multipurpose piping system conforming with all sections of NFPA 13D shall add the following wording to the warning sign required in 6.3(5) of NFPA 13D: "The number and location of sprinklers in this system conform with NFPA 13D."

Note: See Appendix A-82.40 (4) for further explanatory material.

d. A multipurpose piping system that does not conform with all sections of NFPA 13D shall add the following wording to the warning sign required in 6.3(5) of NFPA 13D: "The number and location of sprinklers in this system does not conform with NFPA 13D."

(4) CONTROL VALVES. (a) Private water mains. Private water mains shall be provided with control valves as specified in this subsection.

1. 'Corporation cocks.' a. If a private water main 2" or less in diameter connects to a public water main, a corporation cock shall be installed at the connection to the public water main.

b. If a private water main 2-1/2" or larger in diameter connects to a public water main, a corporation cock shall be installed not more than 8 feet from the connection to the public water main.

2. 'Curb stops.' a. Except as provided in subd. 2. b., if a private water main connects to public water main, a curb stop shall be installed in the private water main between the corporation cock and the property line.

b. If a private water main 2-1/2" or larger in diameter connects to a public water main, one control valve may serve as the corporation cock and the curb stop. The control valve shall be located not more than 8 feet from the connection to the public water main and shall be accessible for operation.

Note: See Appendix A-82.40 (4) for further explanatory material.

(b) *Water services.* Water services shall be provided with control valves as specified in this subsection.

1. 'Corporation cocks.' a. If a water service 2" or less in diameter connects to a public water main, a corporation cock shall be installed at the connection to the public water main.

b. If a water service 2-1/2" or larger in diameter connects to a public water main, a corporation cock shall be installed not more than 8 feet from the connection to the public water main.

2. 'Curb stops.' a. Except for water services serving farm buildings and farm houses, a curb stop shall be installed in each water service which connects to a private water main. The curb stop shall be located outside the building served by the water service.

b. Except as provided in subd. 2. c., a curb stop shall be installed in each water service which connects to a public water main. The curb stop shall be located between the corporation cock and the property line.

c. If a water service 2-1/2" or larger in diameter connects to a public water main, one control valve may serve as the corporation cock and the curb stop. The control valve shall be located not more than 8 feet from the connection to a public water main and shall be accessible for operation.

3. 'Building control valves.' If a water service serves a building, a building control valve shall be provided in the water service as specified in this subsection.

a. If the water service connects to a public water supply or to a private water supply which has an external pressure tank, the building control valve shall be installed inside the building and located within 3 feet of developed length from the point where the water service first enters the building. If a water meter is provided, the building control valve shall be located upstream of the water meter.

b. If a private water supply includes an internal pressure tank, the building control valve shall be installed inside the building and located within 3 feet of developed length downstream from the internal pressure tank.

Note: See Appendix for further explanatory material.

(c) *Water distribution systems.* 1. Control valves shall be installed in water distribution systems serving public buildings as specified in this subdivision.

a. If a water meter is provided, a control valve shall be installed within 3 feet of developed length downstream from the outlet of the water meter. If bypass piping is provided around a water meter, a control valve shall be installed in the bypass piping.

Note: See sub. (8) (d) 3. for the requirements relating to the bypassing of water meters.

b. A control valve shall be installed in the supply piping to each water heater and water treatment device and in the fixture supply to each plumbing fixture, plumbing appliance and piece of equipment. The control valve may be part of the bypass piping or an internal part of a water treatment device. When the valve is an

internal part of the water treatment device, the device shall be removable for service.

c. If a hot water circulation system is provided, a control valve shall be installed on both the inlet and outlet piping to the circulation pump. If a hot water circulation system has 2 or more return pipe lines, a balancing control valve shall be installed in each return piping line.

d. The water distribution system for buildings with more than 4 dwelling units or living units shall be provided with control valves in such numbers and at such locations so that the water supplied to all the units within the building can be isolated into groups of 4 or less units.

Note: See sub. (8) (g) for the valve requirements for water temperature control.

2. Control valves shall be installed in water distribution systems serving one- and 2-family dwellings as specified in this subdivision.

a. If a water meter is provided, a control valve shall be installed within 3 feet of developed length downstream from the outlet of the water meter. If bypass piping is provided around a water meter, a control valve shall be installed in the bypass piping.

Note: See sub. (8) (d) 3. for the requirements relating to the bypassing of water meters.

b. A control valve shall be installed in the supply piping to each water heater and water treatment device and in the fixture supply to each water closet, exterior hose bibb, plumbing appliance and piece of equipment. When the valve is an internal part of the water treatment device, the device shall be removable for service.

c. If a hot water circulation system is provided, a control valve shall be installed on both the inlet and outlet piping to the circulation pump. If a hot water circulation system has 2 or more return pipe lines, a balancing control valve shall be installed in each return piping line.

(5) **HOT WATER SUPPLY SYSTEMS.** (a) *General.* Water heating systems shall be sized to provide sufficient hot water to supply both the daily requirements and hourly peak loads of the building.

(b) *Temperature maintenance.* If the developed length of hot water distribution piping from the source of the hot water supply to a plumbing fixture or appliance exceeds 100 feet, a circulation system or self-regulating electric heating cable shall be provided to maintain the temperature of the hot water within the distribution piping.

1. If a circulation system is used to maintain the temperature, no uncirculated hot water distribution piping may exceed 25 feet in developed length.

2. If a self-regulating electric heating cable is used to maintain the temperature, the cable shall extend to within 25 feet of each fixture or the appliance.

3. Water distribution piping conveying circulated water or served by a self-regulating electric heating cable shall be insulated to limit the heat loss at the external surface of the pipe insulation to a maximum of 25 BTUs per hour per square foot for above-ground piping and 35 BTUs per hour per square foot for underground piping. The maximum heat loss shall be determined at a temperature differential, T, equal to the maximum water temperature minus a design ambient temperature no higher than 65° F.

4. Water distribution piping served by self-regulating electric heating cable shall be identified as being electrically traced in accordance with ch. Comm 16.

5. The installation of self-regulating electric heating cable may be subcontracted by a plumber to another trade.

Note: See A-82.40 (5) for pipe insulation requirements.

(c) *Water heaters.* All water heaters and safety devices shall be designed and constructed in accordance with s. Comm 84.20 (5) (p).

Note: Water heaters are to be installed in accordance with the requirements specified in chs. Comm 60 to 66 and chs. Comm 20 to 25 with respect to energy efficiency, enclosures and venting.

(d) *Safety devices.* Water heaters shall be equipped with safety devices as specified in this paragraph.

1. All pressurized storage-type water heaters and unfired hot water storage tanks shall be equipped with one or more combination temperature and pressure relief valves. The temperature steam rating of a combination temperature and pressure relief valve or valves shall equal or exceed the energy input rating in BTU per hour of the water heater. No shut off valve or other restricting device may be installed between the water heater or storage tank and the combination temperature and pressure relief valve.

Note: The temperature steam rating of a combination temperature and pressure relief valve is commonly referred to as the AGA temperature steam rating.

2. All pressurized non-storage type water heaters shall be provided with a pressure relief valve installed at the hot water outlet with no shut off valve between the heater and the relief valve.

3. Temperature and pressure relief valves shall be installed so that the sensing element of the valve extends into the heater or tank and monitors the temperature in the top 6" of the heater or tank.

4. A vacuum relief valve shall be installed in each water heater and hot water storage tank which, when measured from the bottom of the heater or tank, is located more than 20 feet above any faucet or outlet served by the heater or tank.

5. Every relief valve which is designed to discharge water or steam shall be connected to a discharge pipe.

a. The discharge pipe and fittings shall be made of a material acceptable for water distribution piping in accordance with s. Comm 84.30 (4) (e) 1.

b. The discharge pipe and fittings shall have a diameter not less than the diameter of the relief valve outlet.

c. The discharge pipe may not be trapped.

d. No valve may be installed in the discharge pipe.

e. The discharge pipe shall be installed to drain by gravity flow to a floor served by a floor drain or to a receptor in accordance with s. Comm 82.33 (8). The outlet of the discharge pipe shall terminate within 6" over the floor or receptor, but not less than a distance equal to twice the diameter of the outlet pipe. The outlet of the discharge pipe may not be threaded.

f. The discharge pipe for a water heater shall terminate within the same room or enclosure within which the water heater or hot water storage tank is located.

(e) *Controls.* 1. All hot water supply systems shall be equipped with automatic temperature controls capable of adjustments from the lowest to the highest acceptable temperature settings for the intended use.

2. A separate means shall be provided to terminate the energy supplied to each water heater and each hot water circulation system.

(6) **LOAD FACTORS FOR WATER SUPPLY SYSTEMS.** (a) *Intermittent flow fixtures.* The load factor for intermittent flow fixtures on water supply piping shall be computed in terms of water supply

fixture units as specified in Tables 82.40-1 and 82.40-2 for the corresponding fixture and use. Water supply fixture units may be converted to gallons per minute in accordance with Tables 82.40-3 or 82.40-3c.

(b) *Continuous flow devices.* The load factor for equipment which demands a continuous flow of water shall be computed on the basis of anticipated flow rate in terms of gallons per minute.

Table 82.40-1
WATER SUPPLY FIXTURE UNITS FOR
NONPUBLIC USE FIXTURES

Type of Fixture ^a	Water Supply Fixture Units (wsfu)		
	Hot	Cold	Total
Automatic Clothes Washer	1.0	1.0	1.5
Bar Sink	0.5	0.5	1.0
Bathtub, with or without Shower Head	1.5	1.5	2.0
Bidet	1.0	1.0	1.5
Dishwashing Machine	1.0		1.0
Glass Filler		0.5	0.5
Hose Bibb:			
1/2" diameter		3.0	3.0
3/4" diameter		4.0	4.0
Kitchen Sink	1.0	1.0	1.5
Laundry Tray, 1 or 2 Compartment	1.0	1.0	1.5
Lavatory	0.5	0.5	1.0
Manufactured Home	—	15	15
Shower, Per Head	1.0	1.0	1.5
Water Closet, Flushometer Type		6.0	6.0
Water Closet, Gravity Type Flush Tank		2.0	2.0
Bathroom Groups:			
Bathtub, Lavatory and Water Closet-FM ^b	2.0	7.5	8.0
Bathtub, Lavatory and Water Closet-FT ^c	2.0	3.5	4.0
Shower Stall, Lavatory and Water Closet-FM	1.5	7.0	7.5
Shower Stall, Lavatory and Water Closet-FT	1.5	3.0	3.5

^a For fixtures not listed, factors may be assumed by comparing the fixture to a listed fixture which uses water in similar quantities and at similar rates.

^b FM means flushometer type.

^c FT means flush tank type.

Table 82.40-2

WATER SUPPLY FIXTURE UNITS FOR PUBLIC USE FIXTURES

Type of Fixture ^a	Water Supply Fixture Units (wsfu)		
	Hot	Cold	Total
Automatic Clothes Washer, Individual	2.0	2.0	3.0
Automatic Clothes Washer, Large Capacity	b	b	b
Autopsy Table	2.0	2.0	3.0
Bath tub, With or Without Shower Head	2.0	2.0	3.0
Coffeemaker		0.5	0.5
Dishwasher, Commercial	b	b	b
Drink Dispenser		0.5	0.5
Drinking Fountain		0.25	0.25
Glass Filler		0.5	0.5
Health Care Fixtures:			
Clinic sink	2.0	7.0	7.0
Exam/treatment sink	0.5	0.5	1.0
Sitz bath	1.5	1.5	2.0
Surgeon washup	1.5	1.5	2.0
Hose Bibb:			
1/2" diameter		3.0	3.0
3/4" diameter		4.0	4.0
Icemaker		0.5	0.5
Lavatory	0.5	0.5	1.0
Shower, Per Head	2.0	2.0	3.0
Sinks:			
Bar and Fountain	1.5	1.5	2.0
Barber and Shampoo	1.5	1.5	2.0
Cup		0.5	0.5
Flushing Rim		7.0	7.0
Kitchen and Food Preparation per faucet	2.0	2.0	3.0
Laboratory	1.0	1.0	1.5
Service sink	2.0	2.0	3.0
Urinal:			
Syphon Jet		4.0	4.0
Washdown		2.0	2.0
Wall Hydrant, Hot and Cold Mix:			
1/2" diameter	2.0	2.0	3.0
3/4" diameter	3.0	3.0	4.0
Wash Fountain:			
Semicircular	1.5	1.5	2.0
Circular	2.0	2.0	3.0
Water Closet:			
Flushometer		6.5	6.5
Gravity Type Flush Tank		3.0	3.0

Table 82.40-3

CONVERSION OF WATER SUPPLY FIXTURE UNITS TO GALLONS PER MINUTE

Water Supply Fixture Units	Gallons per Minute	
	Predominately Flushometer Type Water Closets or Syphon Jet Urinals	Predominately Flush Tank Type Water Closets or Washdown Urinals
1	—	1
2	—	2
3	—	3
4	10	4
5	15	4.5
6	18	5
7	21	6
8	24	6.5
9	26	7
10	27	8
20	35	14
30	40	20
40	46	24
50	51	28
60	54	32
70	58	35
80	62	38
90	65	41
100	68	42
120	73	48
140	78	53
160	83	57
180	87	61
200	92	65
250	101	75
300	110	85
400	126	105
500	142	125
600	157	143
700	170	161
800	183	178
900	197	195
1000	208	208
1250	240	240
1500	267	267
1750	294	294
2000	321	321
2250	348	348
2500	375	375
2750	402	402
3000	432	432
4000	525	525
5000	593	593

^a For fixtures not listed, factors may be assumed by comparing the fixture to a listed fixture which uses water in similar quantities and at similar rates.
^b Load factors in gallons per minute, gpm, based on manufacturer's requirements.

Note: Values not specified in the table may be calculated by interpolation.

Table 82.40-3e
CONVERSION OF WATER SUPPLY FIXTURE UNITS
TO GALLONS PER MINUTE FOR WATER
TREATMENT DEVICES^a SERVING
AN INDIVIDUAL DWELLING^b

Water Supply Fixture Units (WSFUs)	Gallons Per Minute (GPM)
1	1
2	2
3	3
4	4
5	4.5
6	5
7	6
8	6.5
25	7
35	8
40	9

^a Treatment devices providing treatment for compliance with Table 82.70-1 shall use Table 82.40-2 for conversion.

^b Table shall not be used for converting hose bibb, high flow fixture or hydrant wsfu.

(7) **SIZING OF WATER SUPPLY PIPING.** The sizing of the water supply system shall be based on the empirical method and limitations outlined in this subsection or on a detailed engineering analysis acceptable to the department.

(a) *Methodology.* The determination of minimum pipe sizes shall take into account the pressure losses which occur throughout the entire water supply system and the flow velocities within the water distribution system. Calculations for sizing a water distribution system shall include:

1. The load factor in water supply fixture units or gallons per minute on the piping;
2. The minimum pressure available from the water main or pressure tank;
3. The pressure loss due to the differences in elevation from the:
 - a. Water main or pressure tank to the building control valve; and
 - b. Building control valve to the controlling plumbing fixture;
4. The pressure losses due to flow through water heaters, water treatment devices, water meters and backflow preventers;
5. The minimum flow pressure needed at the controlling plumbing fixture; and
6. The pressure losses due to flow friction through piping, fittings, valves and other plumbing appurtenances. This pressure loss may be calculated in terms of equivalent lengths of piping. The equivalent length of piping to a controlling plumbing fixture, including fittings, valves and other appurtenances, may be obtained by multiplying the developed length by 1.5.

Note: See Appendix for further explanatory material.

(b) *Private water mains and water services.* Private water mains and water services shall be designed to supply water to the water distribution systems to maintain the minimum flow pressures specified in par. (d), but shall not be less than 3/4" in diameter.

Note: See Appendix for further explanatory material.

(c) *Maximum loading.* The calculated load on any portion of the water distribution system may not exceed the limits specified in Tables 82.40-4 to 82.40-9.

(d) *Pressure.* 1. Except as provided in subd. 1. a. to c., water supply systems shall be designed to provide at least 8 psig of flow pressure at the outlets of all fixture supplies.

a. The flow pressure at the outlets of the fixture supplies serving siphonic type urinals, washdown type urinals and washdown type water closets, siphonic type flushometer water closets and campsite water supply hose connections shall be at least 15 psig.

b. The flow pressure at the outlets of the fixture supplies serving one piece tank type water closets, pressure balance mixing valves, manufactured homes, and thermostatic mixing valves shall be at least 20 psig.

c. The flow pressure at the outlets of the fixture supplies serving blowout type urinals and blowout type water closets shall be at least 25 psig.

2. a. Except as provided in subd. 3., if the water pressure available from a water main or private water supply exceeds 80 psig, a pressure reducing valve and strainer, if a strainer is not a component of the valve, shall be installed in the water distribution system.

b. A pressure reducing valve required under subd. 2. a. shall be installed upstream from all plumbing fixtures and plumbing appliances and downstream from the water meter of an utility, if a meter is provided.

3. A pressure reducing valve shall not be required to be installed in a water distribution system which supplies water directly to a water pressure booster pump.

4. If the pressure available from the water main or private water supply is inadequate by calculation to provide the minimum pressures specified in subd. 1., a hydropneumatic pressure booster system or a water pressure booster pump shall be installed to increase the supply of water.

a. Each water pressure booster pump shall be provided with an automatic low pressure cut-off switch. The cut-off switch shall be located on the inlet side of the pump and shall be set to terminate the energy supplied to the pump when a positive pressure of less than 10 psig occurs.

b. A vacuum relief valve not less than one-half inch in diameter shall be installed in each water pressure tank, if the bottom of the pressure tank is more than 20 feet above any water supply outlet served by the pressure tank.

(e) *Maximum velocity.* A water distribution system shall be designed so that the flow velocity does not exceed 8 feet per second.

(f) *Minimum sizes.* 1. Water distribution piping 1/2" in diameter serving 2 or more plumbing fixtures may not have a load of more than 2 water supply fixture units.

2. Water distribution piping 1/2" in diameter serving a shower which is not individually pressure balanced or individually thermostatically blended may not serve any additional fixtures.

(g) *Minimum sizes for fixture supplies.* Except as provided in subds. 1. to 3., the fixture supplies serving all plumbing fixtures, appliances and pieces of equipment shall be at least 1/2" in diameter.

1. Fixture supplies serving syphon jet type urinals shall be at least 3/4" in diameter.

2. Fixture supplies serving flushometer type water closets shall be at least one inch in diameter.

3. Fixture supplies serving emergency eye wash or shower outlets shall be not less than recommended by the manufacturer.

(h) *Maximum lengths of fixture supply connectors.* 1. a. Except as provided in subd. 1. b. and c., fixture supply connectors may not exceed more than 24" in developed length upstream from a plumbing fixture or the body of a faucet.

b. A fixture supply connector located downstream of a water cooler, water treatment device or water heater which individually serves a faucet or outlet may not exceed more than 10 feet in developed length.

c. A fixture supply connector located upstream of a water treatment device serving no more than 2 fixtures or outlets may not exceed 10 feet in developed length.

2. Fixture supply connectors may not extend more than 10 feet in developed length upstream of a plumbing appliance.

(8) **INSTALLATION.** (a) *Frost protection.* 1. Adequate measures shall be taken to protect all portions of the water supply sys-

tem from freezing. All private water mains and water services shall be installed below the predicted depths of frost specified in s. Comm 82.30 (11) (c) 2. d., Figure 82.30-1 and Table 82.30-6, unless other protective measures from freezing are taken.

2. A hose bibb or a hydrant that penetrates an exterior wall of a heated structure shall be a frost proof and self-draining type.

Note: See s. Comm 82.41 (4) (m) relative to cross connection control devices.

(b) *Location.* 1. Exterior water supply piping may not be located in, under or above sanitary sewer manholes, or POWTS treatment, holding or dispersal components.

2. Except as provided in subd. 3., exterior water supply piping shall be located at least 10 feet horizontally away from a non-pressurized POWTS component.

3. If a private water main or a water service crosses a sanitary sewer, the water piping within 10 feet of the point of crossing shall be installed:

a. At least 12" above the top of the sewer from the bottom of the water piping;

b. At least 18" below the bottom of the sewer from the top of the water piping; or

c. Within a waterproof sleeve made of materials as specified for sanitary building sewers in s. Comm 84.30 (2).

4. Private water mains and water services 2-1/2" or larger in diameter shall be installed at least 8 feet horizontally from any sanitary sewer. The distance shall be measured from center to center of the piping.

5. Except as provided in subd. 6., private water mains and water services 2" or less in diameter shall be installed at least 30" horizontally from any sanitary sewer. The distance shall be measured from center to center of the piping.

6. Private water mains and water services 2" or less in diameter may be installed less than 30" horizontally from a sanitary sewer, if the bottom of the water piping is installed at least 12" above the sewer, except that portion of a water service within 5 feet of developed length from the point where the water service first enters the building may be less than 12" above the sewer.

7. No private water main or water service may be installed within 6" of a storm sewer.

Note: See Appendix A-82.30 (11) (d) for setback distance from yard hydrant to well.

8. Except as provided in subd. 3., no private water main or water service may be installed within 15 feet of a pressurized sanitary sewer or POWTS pump discharge piping.

(c) *Limitations.* No private water main or water service may pass through or under a building to serve another building unless one of the following conditions are met:

1. The private water main or water service serves farm buildings or farm houses, or both that are all located on one property.

2. The private water main or water service serves buildings that are located on the same property and a document which indicates that the piping and distribution arrangement for the property and buildings will be recorded with the register of deeds no later than 90 days after installation.

(d) *Water distribution piping.* 1. Water distribution piping shall be supported in accordance with s. Comm 82.60.

2. Provisions shall be made to evacuate all water out of the water distribution system.

3. a. Except where parallel water meters are installed, water distribution piping shall be provided to bypass a water meter 1 1/2" or larger.

b. The minimum diameter of water distribution piping serving as a meter bypass shall be one nominal pipe size smaller than the meter.

4. Except as provided in subds. 5. and 6., a bypass shall be provided to serve a water treatment device. The bypass piping may be an internal part of the water treatment device.

5. A bypass shall not be required when a water treatment device serves no more than 2 fixtures or outlets.

6. A bypass shall be prohibited for a water treatment device installed to reduce a contaminant in order to comply with the provisions in s. Comm 82.70 (3).

(e) *Valves.* 1. All control valves installed in a water service, except a valve serving only as a corporation cock, shall be accessible.

2. Stop- and waste-type control valves may not be installed underground except in the following situations:

a. Fire hydrants intended for fire fighting.

b. Two-inch and larger diameter hydrants serving municipal wastewater treatment plants.

c. Emergency fixtures.

3. All control valves and fixture stop valves installed in a water distribution system shall be accessible. Control valves for the individual plumbing fixtures and appliances within dwelling units shall be accessible from within the dwelling unit.

(f) *Water hammer arrestors.* All plumbing fixtures, appliances and appurtenances with 3/8" or larger inlet openings and with solenoid actuated quick closing valves shall be provided with water hammer arrestors. Water hammer arrestors shall be installed in the fixture supplies serving the fixtures, appliances or appurtenances. Water hammer arrestors shall be accessible.

(g) *Temperature control.* The water temperature to all showers in public buildings shall be controlled by thermostatic or combination thermostatic-pressure balanced mixing valves or by individually controlled pressure balanced mixing valves. A thermostatic or combination thermostatic-pressure balanced mixing valve may not be bypassed.

(h) *Fittings and connections.* The drilling and tapping of water supply piping shall be prohibited except for:

1. Corporation cocks for a water service or a private water main; and

2. Self-tapping valves which serve individual plumbing appliances.

(i) *Flushing and disinfection of potable water supply systems.*

1. a. Before a newly constructed water supply system is to be put into use, the piping of the system shall be filled with water and allowed to stand for at least 24 hours. After 24 hours each water outlet shall be flushed beginning with the outlet closest to the building control valve and then each successive outlet in the system. The flushing at each water outlet shall continue for at least one minute and until the water appears clear at the outlet.

b. Each portion of a water supply system which is altered or repaired shall be flushed for at least one minute and until the water appears clear.

2. New private water mains and extensions to private water mains shall be disinfected prior to use in accordance with AWWA C651 or the following method:

a. The pipe system shall be flushed with clean water until no dirty water appears at the points of outlet.

b. The system or part thereof shall be filled with a solution of water and chlorine containing at least 50 parts per million of chlorine and the system or part thereof shall be valved off and allowed to stand for 24 hours or the system or part thereof shall be filled with a solution of water and chlorine containing at least 200 parts per million of chlorine and allowed to stand for 3 hours.

c. Following the allowed standing time, the system shall be flushed with clean potable water.

d. The procedures shall be repeated if it is shown by a bacteriological examination that contamination still exists in the system.

3. The department may require a water quality analysis to be done for a new or repaired water supply system. The analysis shall be performed in accordance with acceptable nationally recognized laboratory practices. If the water supply system has been disinfected, water samples for the analysis may not be taken sooner than 24 hours after disinfection.

Note: See s. Comm 84.30 (1) regarding the bending of pipe and protection from puncture.

4. New or repaired combination water services or combination private water mains shall be flushed and disinfected prior to use in accordance with NFPA 24.

(j) *Water softeners.* Ion exchange water softeners used primarily for water hardness reduction that, during regeneration, discharge a brine solution shall be of a demand initiated regeneration type equipped with a water meter or a sensor unless a wastewater treatment system downstream of the water softener specifically documents the reduction of chlorides.

(k) *Locating requirements.* 1. A means to locate buried non-metallic water services and private water mains connected to municipal supply systems shall be provided in accordance with the options under s. Comm 82.30 (11) (h), except as provided in subs. 2. and 3.

2. Tracer wire insulation color for non-metallic, potable water pipe shall be blue.

3. Tracer wire insulation color for non-metallic, non-potable water pipe shall be purple.

(9) **PIPING BY PLUMBER.** In accordance with ch. 145, Stats., piping which conveys water for human use or consumption, or to plumbing fixtures and plumbing appliances of every description, shall be installed by persons licensed by the department.

(a) Private water mains and water services shall be installed by persons licensed by the department as a plumber or utility contractor.

(b) Water distribution piping shall be installed by persons licensed by the department as a plumber.

(c) Except for automatic fire sprinkler systems, piping or piping systems, which may include water heating or water treatment equipment, and which convey water not for human use or con-

sumption from a water distribution system to water using equipment, are not required to be installed by persons licensed by the department.

(d) Where a pipe or piping system, which conveys water not for human use or consumption, connects to a water distribution system, that connection shall be provided with an approved means of backflow prevention in accordance with s. Comm 82.41. The means of backflow prevention shall be installed by persons licensed by the department as a plumber.

History: 1-2-56; r. and recr. Register, November, 1972, No. 203, eff. 12-1-72; r. and recr. Register, February, 1979, No. 278, eff. 3-1-79; renun. from H 62.13, Register, July, 1983, No. 331, eff. 8-1-83; renun. from ILHR 82.13 and r. and recr. (2) (b) and (4) (d) 1., am. (4) (c) 3. and (6) (a) (intro.), cr. (6) (b), Register, February, 1985, No. 350, eff. 3-1-85; r. and recr. Register, May, 1988, No. 389, eff. 6-1-88; am. (5) (d) 5. a., r. and recr. (7) (b) 1. and (8)(c), renun. (8) (c) 2. to 6. to be (8) (b) 4. to 8. and am. (8) (b) 4. c., Register, August, 1991, No. 428, eff. 9-1-91; am. (8) (b) 1. and 2., Register, April, 1992, No. 436, eff. 5-1-92; renun. (3) (c) and (8) (a) to be (3) (c) 2. and (8) (a) 1. and am. (8) (a) 1., cr. (3) (c) 1., (e), (8) (a) 2. and Table 82.40-9, am. (7) (c), r. (3) (b) 1. b. and c., Register, February, 1994, No. 458, eff. 3-1-94; r. (5) (b) 3., renun. (5) (b) 4., 5. to be (5) (b) 3., 4., Register, December, 1996, No. 480, eff. 4-1-96; correction in (5) (b) 3., made under s. 13.93 (2m) (b) 7., Stats., Register, October, 1996, No. 490; r. and recr. (5) (b), Register, February, 1997, No. 494, eff. 4-1-97; reprinted to restore dropped copy, Register, April, 1997, No. 496; am. (3) (e) and (8) (b) 1. and 2., r. (8) (b) 3. and cr. (3) (f) and (8) (j), Register, April, 2000, No. 532, eff. 7-1-00; except (3) (f) eff. 5-1-00; cr. (3) (d) 3., am. (8) (g) and (i) 2., Register, December, 2000, No. 540, eff. 1-1-01; except (3) (d) 3., eff. 9-1-01; CR 02-002: r. and recr. (3) (a), (d) 1. (intro.) to b., (7) (h), (8) (c) and Tables 82.40-4 to 11, cr. (3) (a) 2., (c) 3. and (d) 1. h., am. (3) (b) 1., (4) (c) 1. b. and 2. b., (7) (d) 1. a. and b., (8) (d) 4., (g), and Tables 82.40-1 and 2, r. (3) (e), renun. (3) (f) and (8) (b) 4. to 8. to be (3) (e) and (8) (b) 3. to 7., Register April 2003 No. 568, eff. 5-1-03; CR 02-129: am. (4) (c) 1. b. Register January 2004 No. 577, eff. 2-1-04, correction in (8) (b) 5. made under s. 13.93 (2m) b. 7., Stats., Register January 2004 No. 577; CR 04-035: r. (3) (e) 2. c., r. and recr. Table 82.40-9, cr. (8) (f) 4. Register November 2004 No. 587, eff. 12-1-04; CR 06-120: r. and recr. (3) (e) 2. b., cr. (3) (e) 2. c. Register February 2008 No. 626, eff. 3-1-08; CR 07-069: cr. (8) (k) Register February 2008 No. 626, eff. 3-1-08; CR 07-100: am. (8) (b) 2. Register September 2008 No. 633, eff. 10-1-08; CR 08-055: am. (3) (b) 1. b., (d) 3. (intro.), (5) (c), (6) (a), (7) (d) 1. b., (8) (b) 2., (j), Tables 82.40-1 and 82.40-2, r. and recr. (3) (e), (8) (e) 2., cr. (8) (b) 8., (d) 3. b. and Table 82.40-3e, renun. (8) (d) 3. to be (8) (d) 3. a. Register February 2009 No. 638, eff. 3-1-09.

This Page Intentionally Left Blank

Table 82.40-4
 MAXIMUM ALLOWABLE LOAD FOR COPPER TUBING—TYPE K, ASTM B88; (C=150)

Pressure Loss Due to Friction (in lbs. per 100 ft. of Length)	Pipe Diameter (in inches)																	
	1/2"		3/4"		1"		1 1/4"		1 1/2"		2"		2 1/2"		3"		4"	
	GPM	WSFU	GPM	WSFU	GPM	WSFU	GPM	WSFU	GPM	WSFU	GPM	WSFU	GPM	WSFU	GPM	WSFU	GPM	WSFU
0.5	0.5	1.5	3.5	5.0	7.5	10.5	14.0	17.5	22.0	28.0	35.0	42.0	50.0	60.0	70.0	83.0	91.0	103
1	1.0	2.5	5.0	7.5	11.5	15.5	20.5	25.5	32.0	40.0	50.0	60.0	73.0	86.0	100	116	132	151
2	1.0	3.5	7.5	11.5	17.5	22.0	28.0	34.0	42.0	52.0	65.0	80.0	95.0	110	128	150	172	198
3	1.5	4.5	9.5	14.0	20.5	26.0	33.0	40.0	49.0	60.0	75.0	90.0	108	128	150	175	201	231
4	2.0	5.0	10.5	15.5	22.0	28.0	35.0	42.0	51.0	62.0	78.0	95.0	115	135	160	185	215	250
5	2.0	6.0	12.0	18.0	24.0	30.0	37.0	45.0	55.0	68.0	85.0	105	128	155	185	220	260	300
6	2.5	6.5	13.0	19.0	25.0	31.0	38.0	46.0	56.0	70.0	88.0	108	132	160	195	235	280	330
7	2.5	7.0	14.0	20.0	26.0	32.0	39.0	47.0	58.0	72.0	90.0	110	135	165	200	245	295	350
8	3.0	7.5	15.0	21.0	27.0	33.0	40.0	48.0	59.0	74.0	92.0	112	138	170	210	255	310	370
9	3.0	8.0	16.0	22.0	28.0	34.0	41.0	49.0	60.0	76.0	95.0	115	142	175	215	260	320	385
10	3.5	8.5	17.0	23.0	29.0	35.0	42.0	50.0	62.0	78.0	98.0	118	145	180	220	265	330	400
11	3.5	9.0	18.0	24.0	30.0	36.0	43.0	51.0	64.0	80.0	100.0	120	148	185	225	270	340	415
12	3.5	9.5	19.0	25.0	31.0	37.0	44.0	52.0	66.0	82.0	103.0	125	152	190	230	275	350	430
13	4.0	10.0	20.0	26.0	32.0	38.0	45.0	53.0	68.0	85.0	106.0	128	158	195	235	280	360	445
14	4.0	10.5	21.0	27.0	33.0	39.0	46.0	54.0	70.0	88.0	110.0	132	162	200	240	285	370	460
15	4.0	10.5	21.0	27.0	33.0	39.0	46.0	54.0	70.0	88.0	110.0	132	162	200	240	285	370	460
16	4.5	5.0	NP	NP	NP	NP	NP	NP	NP	NP	NP	NP	NP	NP	NP	NP	NP	NP
17	4.5	5.0	NP	NP	NP	NP	NP	NP	NP	NP	NP	NP	NP	NP	NP	NP	NP	NP
18	4.5	5.0	NP	NP	NP	NP	NP	NP	NP	NP	NP	NP	NP	NP	NP	NP	NP	NP
19	5.0	6.0	NP	NP	NP	NP	NP	NP	NP	NP	NP	NP	NP	NP	NP	NP	NP	NP

Note:WSFU means water supply fixture units.

GPM means gallons per minute.

FM means predominately flushometer type water closets or syphon jet urinals.

FT means predominately flush tank type water closets or wash down urinals.

NP means not permitted, velocities exceed 8 feet per second.

For using this table, round the calculated pressure loss due to friction to the next higher number shown.

Comm 82.40 (7) (f) and (g) specifies minimum sizes for water distribution piping.

**Table 82.40-5
MAXIMUM ALLOWABLE LOAD FOR COPPER TUBING-TYPE L, ASTM B88; (C=150)**

Pressure Loss Due to Friction (in lbs. per 100 ft. of Length)	Pipe Diameter (in inches)																															
	1/2"		3/4"		1"		1 1/4"		1 1/2"		2"		2 1/2"		3"		4"															
	GPM	WSFU	GPM	WSFU	GPM	WSFU	GPM	WSFU	GPM	WSFU	GPM	WSFU	GPM	WSFU	GPM	WSFU	GPM	WSFU														
0.5	0.5	-	0.5	2.0	-	2.0	4.0	-	4.0	7.0	-	9.0	11.0	4.0	15.0	23.0	7.5	37.0	40.0	30.0	86.0	65.0	90.0	200	136	462	561					
1	1.0	-	1.0	2.5	-	2.5	5.5	-	6.5	10.0	-	13.0	16.0	5.0	23.0	33.0	17.5	63.0	59.0	72.0	170	94.0	211	345	198	909	923					
2	1.5	-	1.5	4.0	-	4.0	8.5	-	10.5	14.5	-	20.5	23.0	7.5	37.0	48.0	44.0	120	86.0	175	305	137	468	566	288	1694	1694					
3	2.0	-	2.0	5.0	-	6.0	10.5	-	14.0	18.5	-	27.5	29.0	12.5	52.0	60.0	75.0	175	107	283	410	169	698	752	298	1792	1792					
4	2.0	-	2.0	6.0	-	7.0	12.0	-	16.5	21.5	-	33.0	34.0	18.5	66.0	70.0	108	225	119	356	469	NP	NP	NP	NP	NP	NP					
5	2.5	-	2.5	6.5	-	8.0	14.0	-	20.0	24.0	-	40.0	38.0	26.0	80.0	77.0	136	260	NP	NP	NP	NP	NP	NP	NP	NP	NP	NP				
6	2.5	-	2.5	7.5	-	9.5	15.5	-	22.5	26.0	-	45.0	42.0	33.0	100	NP	NP	NP	NP	NP	NP	NP	NP	NP	NP	NP	NP	NP				
7	3.0	-	3.0	8.0	-	10.0	16.5	-	24.0	29.0	-	52.0	44.0	37.0	107	NP	NP	NP	NP	NP	NP	NP	NP	NP	NP	NP	NP	NP	NP			
8	3.0	-	3.0	8.5	-	10.5	18.0	-	26.5	31.0	-	58.0	NP	NP	NP	NP	NP	NP	NP	NP	NP	NP	NP	NP	NP	NP	NP	NP	NP			
9	3.5	-	3.5	9.5	-	12.5	19.0	-	28.0	NP	-	NP	NP	NP	NP	NP	NP	NP	NP	NP	NP	NP	NP	NP	NP	NP	NP	NP	NP	NP		
10	3.5	-	3.5	10.0	-	13.0	20.0	-	30.0	NP	-	NP	NP	NP	NP	NP	NP	NP	NP	NP	NP	NP	NP	NP	NP	NP	NP	NP	NP	NP		
11	4.0	-	4.0	10.5	-	14.0	20.5	-	31.0	NP	-	NP	NP	NP	NP	NP	NP	NP	NP	NP	NP	NP	NP	NP	NP	NP	NP	NP	NP	NP		
12	4.0	-	4.0	11.0	-	15.0	NP	-	NP	NP	-	NP	NP	NP	NP	NP	NP	NP	NP	NP	NP	NP	NP	NP	NP	NP	NP	NP	NP	NP	NP	
13	4.0	-	4.0	11.5	-	15.5	NP	-	NP	NP	-	NP	NP	NP	NP	NP	NP	NP	NP	NP	NP	NP	NP	NP	NP	NP	NP	NP	NP	NP	NP	
14	4.5	-	5.0	12.0	-	16.5	NP	-	NP	NP	-	NP	NP	NP	NP	NP	NP	NP	NP	NP	NP	NP	NP	NP	NP	NP	NP	NP	NP	NP	NP	
15	4.5	-	5.0	NP	-	NP	NP	-	NP	NP	-	NP	NP	NP	NP	NP	NP	NP	NP	NP	NP	NP	NP	NP	NP	NP	NP	NP	NP	NP	NP	
16	5.0	-	6.0	NP	-	NP	NP	-	NP	NP	-	NP	NP	NP	NP	NP	NP	NP	NP	NP	NP	NP	NP	NP	NP	NP	NP	NP	NP	NP	NP	
17	5.0	-	6.0	NP	-	NP	NP	-	NP	NP	-	NP	NP	NP	NP	NP	NP	NP	NP	NP	NP	NP	NP	NP	NP	NP	NP	NP	NP	NP	NP	NP
18	5.0	-	6.0	NP	-	NP	NP	-	NP	NP	-	NP	NP	NP	NP	NP	NP	NP	NP	NP	NP	NP	NP	NP	NP	NP	NP	NP	NP	NP	NP	NP
19	5.0	-	6.0	NP	-	NP	NP	-	NP	NP	-	NP	NP	NP	NP	NP	NP	NP	NP	NP	NP	NP	NP	NP	NP	NP	NP	NP	NP	NP	NP	NP
20	5.5	-	6.5	NP	-	NP	NP	-	NP	NP	-	NP	NP	NP	NP	NP	NP	NP	NP	NP	NP	NP	NP	NP	NP	NP	NP	NP	NP	NP	NP	NP

Note: WSFU means water supply fixture units.

GPM means gallons per minute.

FM means predominately flushometer type water closets or syphon jet urinals.

FT means predominately flush tank type water closets or wash down urinals.

NP means not permitted, velocities exceed 8 feet per second.

For using this table, round the calculated pressure loss due to friction to the next higher number shown.

Comm 82.40 (7) (f) and (g) specifies minimum sizes for water distribution piping.

Table 82.40-6
MAXIMUM ALLOWABLE LOAD FOR COPPER TUBING—TYPE M, ASTM B88; (C=150)

Pressure Loss Due to Friction (in lbs. per 100 ft. of Length)	Pipe Diameter (in inches)																	
	1/2"		3/4"		1"		1 1/4"		1 1/2"		2"		2 1/2"		3"		4"	
	GPM	WSFU	GPM	WSFU	GPM	WSFU	GPM	WSFU	GPM	WSFU	GPM	WSFU	GPM	WSFU	GPM	WSFU	GPM	WSFU
0.5	0.5	2.0	2.0	4.0	4.0	7.0	9.0	11.5	15.5	23.0	37.0	42.0	42.0	67.0	100	139	139	577
1	1.0	3.0	3.0	6.0	6.0	10.5	14.0	16.5	24.0	34.0	50.0	50.0	50.0	97.0	180	202	202	953
2	1.5	4.5	4.5	9.0	9.0	15.5	20.5	24.0	35.0	50.0	73.0	73.0	73.0	141	240	277	277	1150
3	2.0	5.5	5.5	11.5	11.5	19.5	25.5	30.0	40.0	55.0	80.0	80.0	80.0	174	300	341	341	1350
4	2.5	6.5	6.5	13.0	13.0	22.0	29.0	35.0	45.0	60.0	85.0	85.0	85.0	174	300	341	341	1350
5	2.5	7.5	7.5	15.0	15.0	25.0	32.0	40.0	50.0	65.0	90.0	90.0	90.0	174	300	341	341	1350
6	3.0	8.0	8.0	16.5	16.5	28.0	35.0	45.0	55.0	70.0	95.0	95.0	95.0	174	300	341	341	1350
7	3.5	9.0	9.0	18.0	18.0	30.0	38.0	48.0	60.0	75.0	100.0	100.0	100.0	174	300	341	341	1350
8	3.5	9.5	9.5	19.5	19.5	32.0	40.0	50.0	60.0	75.0	100.0	100.0	100.0	174	300	341	341	1350
9	4.0	10.0	10.0	20.5	20.5	34.0	42.0	52.0	62.0	77.0	102.0	102.0	102.0	174	300	341	341	1350
10	4.0	11.0	11.0	21.5	21.5	34.0	42.0	52.0	62.0	77.0	102.0	102.0	102.0	174	300	341	341	1350
11	4.5	11.5	11.5	22.0	22.0	34.0	42.0	52.0	62.0	77.0	102.0	102.0	102.0	174	300	341	341	1350
12	4.5	12.0	12.0	23.0	23.0	34.0	42.0	52.0	62.0	77.0	102.0	102.0	102.0	174	300	341	341	1350
13	5.0	12.5	12.5	24.0	24.0	34.0	42.0	52.0	62.0	77.0	102.0	102.0	102.0	174	300	341	341	1350
14	5.0	13.0	13.0	25.0	25.0	34.0	42.0	52.0	62.0	77.0	102.0	102.0	102.0	174	300	341	341	1350
15	5.0	13.5	13.5	26.0	26.0	34.0	42.0	52.0	62.0	77.0	102.0	102.0	102.0	174	300	341	341	1350
16	5.5	14.0	14.0	27.0	27.0	34.0	42.0	52.0	62.0	77.0	102.0	102.0	102.0	174	300	341	341	1350
17	5.5	14.5	14.5	28.0	28.0	34.0	42.0	52.0	62.0	77.0	102.0	102.0	102.0	174	300	341	341	1350
18	5.5	15.0	15.0	29.0	29.0	34.0	42.0	52.0	62.0	77.0	102.0	102.0	102.0	174	300	341	341	1350
19	6.0	15.5	15.5	30.0	30.0	34.0	42.0	52.0	62.0	77.0	102.0	102.0	102.0	174	300	341	341	1350
20	6.0	16.0	16.0	31.0	31.0	34.0	42.0	52.0	62.0	77.0	102.0	102.0	102.0	174	300	341	341	1350
21	6.0	16.5	16.5	32.0	32.0	34.0	42.0	52.0	62.0	77.0	102.0	102.0	102.0	174	300	341	341	1350

Note: WSFU means water supply fixture units.
 GPM means gallons per minute.
 FM means predominantly flushometer type water closets or syphon jet urinals.
 FT means predominantly flush tank type water closets or wash down urinals.
 NP means not permitted, velocities exceed 8 feet per second.
 For using this table, round the calculated pressure loss due to friction to the next higher number shown.
 Comm 82.40 (7) (f) and (g) specifies minimum sizes for water distribution piping.

Table 82.40-7
MAXIMUM ALLOWABLE LOAD FOR GALVANIZED STEEL PIPE, SCHEDULE 40, ASTM A53; (C=150)

Pressure Loss Due to Friction (in lbs. per 100 ft. of Length)	Pipe Diameter (in inches)																								
	1/2"		3/4"		1"		1 1/4"		1 1/2"		2"		2 1/2"		3"		4"								
	GPM	WSFU	GPM	WSFU	GPM	WSFU	GPM	WSFU	GPM	WSFU	GPM	WSFU	GPM	WSFU	GPM	WSFU	GPM	WSFU							
0.5	0.5	-	1.5	-	3.5	-	7.0	-	9.0	11.0	4.0	15.0	21.0	7.0	32.0	34.0	18.5	66.0	60.0	75.0	175	123	381	490	
1	1.0	-	2.5	-	5.0	-	10.5	4.0	14.0	16.0	5.0	23.0	31.0	15.0	57.0	49.0	46.0	124	87.0	180	310	179	769	805	
2	1.5	-	4.0	-	7.5	-	15.5	5.0	22.5	23.0	7.5	37.0	45.0	38.0	110	72.0	116	235	127	406	511	260	1435	1435	
3	2.0	-	5.0	-	9.0	-	19.0	6.0	28.0	29.0	12.5	52.0	56.0	65.0	155	89.0	188	320	158	607	683	317	1966	1966	
4	2.5	-	5.5	-	11.0	4.0	22.0	7.0	35.0	34.0	18.5	66.0	65.0	90	200	104	266	395	184	809	837	NP	NP	NP	
5	3.0	-	6.5	-	12.0	4.0	25.0	8.5	42.0	38.0	26.0	80.0	74.0	124	245	118	350	465	NP	NP	NP	NP	NP	NP	NP
6	3.0	-	7.0	-	13.5	4.5	28.0	11.0	50.0	42.0	33.0	100	81.0	152	280	119	358	471	NP	NP	NP	NP	NP	NP	NP
7	3.5	-	7.5	-	14.5	4.5	30.0	13.5	55.0	46.0	40.0	113	83.0	163	293	NP	NP	NP	NP	NP	NP	NP	NP	NP	NP
8	4.0	-	8.0	-	16.0	5.0	33.0	17.5	63.0	49.0	46.0	124	NP	NP	NP	NP	NP	NP	NP	NP	NP	NP	NP	NP	NP
9	4.0	-	9.0	-	17.0	5.5	35.0	20.0	70.0	50.0	49.0	131	NP	NP	NP	NP	NP	NP	NP	NP	NP	NP	NP	NP	NP
10	4.5	-	9.5	-	18.0	6.0	37.0	24.0	76.0	NP	NP	NP	NP	NP	NP	NP	NP	NP	NP	NP	NP	NP	NP	NP	NP
11	4.5	-	10.0	4.0	19.0	6.0	37.0	24.0	77.0	NP	NP	NP	NP	NP	NP	NP	NP	NP	NP	NP	NP	NP	NP	NP	NP
12	5.0	-	10.5	4.0	19.5	6.5	29.0	NP	NP	NP	NP	NP	NP	NP	NP	NP	NP	NP	NP	NP	NP	NP	NP	NP	NP
13	5.0	-	11.0	4.0	20.5	6.5	31.0	NP	NP	NP	NP	NP	NP	NP	NP	NP	NP	NP	NP	NP	NP	NP	NP	NP	NP
14	5.0	-	11.0	4.0	21.5	7.0	33.0	NP	NP	NP	NP	NP	NP	NP	NP	NP	NP	NP	NP	NP	NP	NP	NP	NP	NP
15	5.5	-	11.5	4.0	21.5	7.0	33.0	NP	NP	NP	NP	NP	NP	NP	NP	NP	NP	NP	NP	NP	NP	NP	NP	NP	NP
16	5.5	-	12.0	4.0	21.5	7.0	33.0	NP	NP	NP	NP	NP	NP	NP	NP	NP	NP	NP	NP	NP	NP	NP	NP	NP	NP
17	6.0	-	12.5	4.5	21.5	7.0	33.0	NP	NP	NP	NP	NP	NP	NP	NP	NP	NP	NP	NP	NP	NP	NP	NP	NP	NP
18	6.0	-	13.0	4.5	21.5	7.0	33.0	NP	NP	NP	NP	NP	NP	NP	NP	NP	NP	NP	NP	NP	NP	NP	NP	NP	NP
19	6.0	-	13.0	4.5	21.5	7.0	33.0	NP	NP	NP	NP	NP	NP	NP	NP	NP	NP	NP	NP	NP	NP	NP	NP	NP	NP
20	6.5	-	8.0	NP	NP	NP	NP	NP	NP	NP	NP	NP	NP	NP	NP	NP	NP	NP	NP	NP	NP	NP	NP	NP	NP
21	6.5	-	8.0	NP	NP	NP	NP	NP	NP	NP	NP	NP	NP	NP	NP	NP	NP	NP	NP	NP	NP	NP	NP	NP	NP
22	7.0	-	9.0	NP	NP	NP	NP	NP	NP	NP	NP	NP	NP	NP	NP	NP	NP	NP	NP	NP	NP	NP	NP	NP	NP
23	7.0	-	9.0	NP	NP	NP	NP	NP	NP	NP	NP	NP	NP	NP	NP	NP	NP	NP	NP	NP	NP	NP	NP	NP	NP
24	7.0	-	9.0	NP	NP	NP	NP	NP	NP	NP	NP	NP	NP	NP	NP	NP	NP	NP	NP	NP	NP	NP	NP	NP	NP
25	7.5	-	9.5	NP	NP	NP	NP	NP	NP	NP	NP	NP	NP	NP	NP	NP	NP	NP	NP	NP	NP	NP	NP	NP	NP

Note: WSFU means water supply fixture units.

GPM means gallons per minute.

FM means predominately flushometer type water closets or syphon jet urinals.

FT means predominately flush tank type water closets or wash down urinals.

NP means not permitted, velocities exceed 8 feet per second.

For using this table, round the calculated pressure loss due to friction to the next higher number shown.

Comm 82.40 (7) (f) and (g) specifies minimum sizes for water distribution piping.

Table 82.40-8
**MAXIMUM ALLOWABLE LOAD FOR POLYBUTYLENE TUBING, ASTM D3309 and
 CHLORINATED POLYVINYL CHLORIDE TUBING, ASTM D2846; (C=150)**

Pressure Loss Due to Friction (in lbs. per 100 ft. of Length)	Pipe Diameter (in inches)																	
	1/2"			3/4"			1"			1 1/4"			1 1/2"			2"		
	GPM	WSFU FM	FT	GPM	WSFU FM	FT	GPM	WSFU FM	FT	GPM	WSFU FM	FT	GPM	WSFU FM	FT	GPM	WSFU FM	FT
0.5	0.5	-	0.5	1.5	-	1.5	3.0	-	3.0	5.0	-	6.0	8.0	-	10.0	16.0	5.0	23.0
1	0.5	-	0.5	2.0	-	2.0	4.0	-	4.0	7.5	-	9.5	11.5	4.0	15.5	23.0	7.5	37.0
2	1.0	-	1.0	3.0	-	3.0	6.0	-	7.0	10.5	4.0	14.0	16.5	5.5	24.0	34.0	18.5	66.0
3	1.5	-	1.5	4.0	-	4.0	8.0	-	10.0	13.5	4.5	19.0	21.0	7.0	32.0	42.0	33.0	100
4	1.5	-	1.5	4.5	-	5.0	9.0	-	11.5	15.5	5.0	22.5	24.0	8.0	40.0	50.0	48.0	128
5	2.0	-	2.0	5.0	-	6.0	10.5	4.0	14.0	17.5	5.5	25.5	27.0	10.0	47.0	56.0	65.0	155
6	2.0	-	2.0	6.0	-	7.0	11.5	4.0	15.5	19.5	6.5	29.0	30.0	13.5	55.0	59.0	73.0	171
7	2.0	-	2.0	6.5	-	8.0	12.5	4.5	17.5	21.5	7.0	33.0	33.0	17.5	63.0	NP	NP	NP
8	2.5	-	2.5	7.0	-	9.0	13.5	4.5	19.0	23.0	7.5	37.0	34.0	19.0	68.0	NP	NP	NP
9	2.5	-	2.5	7.5	-	9.5	14.5	4.5	20.5	24.0	8.0	40.0	NP	NP	NP	NP	NP	NP
10	2.5	-	2.5	8.0	-	10.0	15.0	5.0	21.5	24.0	8.0	41.0	NP	NP	NP	NP	NP	NP
11	3.0	-	3.0	8.5	-	10.5	16.0	5.0	23.0	NP	NP	NP	NP	NP	NP	NP	NP	NP
12	3.0	-	3.0	9.0	-	11.5	16.5	5.5	24.0	NP	NP	NP	NP	NP	NP	NP	NP	NP
13	3.0	-	3.0	9.5	-	12.5	NP	NP	NP	NP	NP	NP	NP	NP	NP	NP	NP	NP
14	3.0	-	3.0	9.5	-	12.5	NP	NP	NP	NP	NP	NP	NP	NP	NP	NP	NP	NP
15	3.5	-	3.5	10.0	-	13.0	NP	NP	NP	NP	NP	NP	NP	NP	NP	NP	NP	NP
16	3.5	-	3.5	10.0	-	13.0	NP	NP	NP	NP	NP	NP	NP	NP	NP	NP	NP	NP
17	3.5	-	3.5	NP	-	NP	NP	NP	NP	NP	NP	NP	NP	NP	NP	NP	NP	NP
18	4.0	-	4.0	NP	-	NP	NP	NP	NP	NP	NP	NP	NP	NP	NP	NP	NP	NP
19	4.0	-	4.0	NP	-	NP	NP	NP	NP	NP	NP	NP	NP	NP	NP	NP	NP	NP
20	4.0	-	4.0	NP	-	NP	NP	NP	NP	NP	NP	NP	NP	NP	NP	NP	NP	NP
21	4.0	-	4.0	NP	-	NP	NP	NP	NP	NP	NP	NP	NP	NP	NP	NP	NP	NP
22	4.0	-	4.0	NP	-	NP	NP	NP	NP	NP	NP	NP	NP	NP	NP	NP	NP	NP
23	4.5	-	5.0	NP	-	NP	NP	NP	NP	NP	NP	NP	NP	NP	NP	NP	NP	NP

Note: WSFU means water supply fixture units.

GPM means gallons per minute.

FM means predominately flushometer type water closets or syphon jet urinals.

FT means predominately flush tank type water closets or wash down urinals.

NP means not permitted, velocities exceed 8 feet per second.

For using this table, round the calculated pressure loss due to friction to the next higher number shown.

Comm 82.40 (7) (f) and (g) specifies minimum sizes for water distribution piping.

Table 82.40-9
MAXIMUM ALLOWABLE LOAD FOR CROSSLINKED POLYETHYLENE (PEX) TUBING,
ASTM F876 and F877; (C=150)

Pressure Loss Due to Friction (in lbs. per 100 ft. of Length)	Pipe Diameter (in inches)																					
	1/2"			5/8"			3/4"			1"			1 1/4"			1 1/2"			2"			
	GPM	WSFU FM	FT	GPM	WSFU FM	FT	GPM	WSFU FM	FT	GPM	WSFU FM	FT	GPM	WSFU FM	FT	GPM	WSFU FM	FT	GPM	WSFU FM	FT	
0.5	0.5	-	0.5	0.5	-	0.5	1.0	-	1.0	2.5	-	2.5	4.0	-	4.0	6.5	-	6.5	13.5	-	13.5	19.0
1	0.5	-	0.5	1.0	-	1.0	1.5	-	1.5	3.5	-	3.5	6.0	-	6.0	9.0	-	9.0	19.5	-	19.5	29.0
2	1.0	-	1.0	1.5	-	1.5	2.5	-	2.5	5.0	-	5.0	9.0	-	9.0	11.0	-	11.0	28.0	-	28.0	50.0
3	1.0	-	1.0	2.0	-	2.0	3.0	-	3.0	6.5	-	6.5	11.0	-	11.0	15.0	-	15.0	36.0	-	36.0	73.0
4	1.5	-	1.5	2.5	-	2.5	4.0	-	4.0	7.5	-	7.5	13.0	-	13.0	18.0	-	18.0	42.0	-	42.0	100
5	1.5	-	1.5	3.0	-	3.0	4.5	-	4.5	8.5	-	8.5	15.0	-	15.0	21.5	-	21.5	47.0	-	47.0	116
6	2.0	-	2.0	3.0	-	3.0	5.0	-	5.0	9.5	-	9.5	16.5	-	16.5	24.0	-	24.0	51.0	-	51.0	135
7	2.0	-	2.0	3.5	-	3.5	5.5	-	5.5	10.5	-	10.5	18.0	-	18.0	26.5	-	26.5	28.0	-	28.0	NP
8	2.0	-	2.0	3.5	-	3.5	5.5	-	5.5	11.0	-	11.0	19.0	-	19.0	28.0	-	28.0	30.0	-	30.0	NP
9	2.5	-	2.5	4.0	-	4.0	6.0	-	6.0	12.0	-	12.0	20.5	-	20.5	31.0	-	31.0	31.0	-	31.0	NP
10	2.5	-	2.5	4.0	-	4.0	6.5	-	6.5	12.5	-	12.5	21.5	-	21.5	34.0	-	34.0	NP	-	NP	NP
11	2.5	-	2.5	4.5	-	4.5	7.0	-	7.0	13.5	-	13.5	19.0	-	19.0	NP	-	NP	NP	-	NP	NP
12	2.5	-	2.5	4.5	-	4.5	7.0	-	7.0	14.0	-	14.0	20.0	-	20.0	NP	-	NP	NP	-	NP	NP
13	3.0	-	3.0	5.0	-	5.0	7.5	-	7.5	14.5	-	14.5	20.5	-	20.5	NP	-	NP	NP	-	NP	NP
14	3.0	-	3.0	5.0	-	5.0	8.0	-	8.0	15.0	-	15.0	21.0	-	21.0	NP	-	NP	NP	-	NP	NP
15	3.0	-	3.0	5.5	-	5.5	8.0	-	8.0	15.5	-	15.5	21.5	-	21.5	NP	-	NP	NP	-	NP	NP
16	3.0	-	3.0	5.5	-	5.5	8.0	-	8.0	16.0	-	16.0	22.0	-	22.0	NP	-	NP	NP	-	NP	NP
17	3.5	-	3.5	5.5	-	5.5	8.5	-	8.5	16.5	-	16.5	22.5	-	22.5	NP	-	NP	NP	-	NP	NP
18	3.5	-	3.5	6.0	-	6.0	7.0	-	7.0	17.0	-	17.0	23.0	-	23.0	NP	-	NP	NP	-	NP	NP
19	3.5	-	3.5	6.0	-	6.0	7.5	-	7.5	17.5	-	17.5	23.5	-	23.5	NP	-	NP	NP	-	NP	NP
20	3.5	-	3.5	6.0	-	6.0	7.5	-	7.5	18.0	-	18.0	24.0	-	24.0	NP	-	NP	NP	-	NP	NP
21	4.0	-	4.0	NP	-	NP	NP	-	NP	NP	-	NP	NP	-	NP	NP	-	NP	NP	-	NP	NP

Note: WSFU means water supply fixture units.

GPM means gallons per minute.

FM means predominately flushometer type water closets or syphon jet urinals.

FT means predominately flush tank type water closets or wash down urinals.

NP means - not permitted, velocities exceed 8 feet per second.

For using this table, round the calculated pressure loss due to friction

to the next higher number shown.

Comm 82.40 (7) (f) and (g) specifies minimum sizes for water distribution piping.

Table 82.40-10
MAXIMUM ALLOWABLE LOAD FOR CHLORINATED POLYVINYL CHLORIDE TUBING, ASTM F442; (C=150)

Pressure Loss Due to Friction (in lbs. per 100 ft. of Length)	Pipe Diameter (in inches)																									
	3/4"			1"			1 1/4"			1 1/2"			2"			2 1/2"			3"							
	GPM	WSFU FM	WSFU FT	GPM	WSFU FM	WSFU FT	GPM	WSFU FM	WSFU FT	GPM	WSFU FM	WSFU FT	GPM	WSFU FM	WSFU FT	GPM	WSFU FM	WSFU FT	GPM	WSFU FM	WSFU FT					
0.5	2.5	-	2.5	4.5	-	5.0	9.0	-	11.5	13.0	4.5	18.0	23.0	7.5	37.0	18.5	66.0	62.0	80.0	185	102	255	385	170	703	755
1	3.5	-	3.5	7.0	-	9.0	13.0	4.5	18.0	18.5	6.0	27.5	34.0	18.5	46.0	30.0	86.0	72.0	116	235	114	331	449	NP	NP	NP
2	5.5	-	6.5	10.0	4.0	13.0	19.0	6.0	28.0	27.0	10.0	47.0	49.0	46.0	124	38.0	110	78.0	142	267	NP	NP	NP	NP	NP	NP
3	7.0	-	9.0	12.5	4.5	17.5	23.0	7.5	37.0	34.0	18.5	66.0	62.0	80.0	185	102	255	385	170	703	755	NP	NP	NP	NP	NP
4	8.0	-	10.0	15.0	5.0	21.5	27.0	10.0	47.0	40.0	30.0	86.0	72.0	116	235	114	331	449	NP	NP	NP	NP	NP	NP	NP	NP
5	9.0	-	11.5	16.5	5.5	24.0	31.0	15.0	57.0	45.0	38.0	110	78.0	142	267	NP	NP	NP	NP	NP	NP	NP	NP	NP	NP	NP
6	10.0	4.0	13.0	18.5	6.0	27.5	34.0	18.5	66.0	49.0	46.0	124	NP	NP	NP	NP	NP	NP	NP	NP	NP	NP	NP	NP	NP	NP
7	11.0	4.0	15.0	20.0	6.5	30.0	37.0	24.0	76.0	50.0	48.0	128	NP	NP	NP	NP	NP	NP	NP	NP	NP	NP	NP	NP	NP	NP
8	11.5	4.0	15.5	21.5	7.0	33.0	38.0	26.0	80.0	NP	NP	NP	NP	NP	NP	NP	NP	NP	NP	NP	NP	NP	NP	NP	NP	NP
9	12.5	4.5	17.5	23.0	7.5	37.0	NP	NP	NP	NP	NP	NP	NP	NP	NP	NP	NP	NP	NP	NP	NP	NP	NP	NP	NP	NP
10	13.0	4.5	18.0	23.0	7.5	39.0	NP	NP	NP	NP	NP	NP	NP	NP	NP	NP	NP	NP	NP	NP	NP	NP	NP	NP	NP	NP
11	14.0	4.5	20.0	NP	NP	NP	NP	NP	NP	NP	NP	NP	NP	NP	NP	NP	NP	NP	NP	NP	NP	NP	NP	NP	NP	NP
12	14.5	4.5	20.5	NP	NP	NP	NP	NP	NP	NP	NP	NP	NP	NP	NP	NP	NP	NP	NP	NP	NP	NP	NP	NP	NP	NP
13	14.5	5.0	21.5	NP	NP	NP	NP	NP	NP	NP	NP	NP	NP	NP	NP	NP	NP	NP	NP	NP	NP	NP	NP	NP	NP	NP

Note: WSFU means water supply fixture units.

GPM means gallons per minute.

FM means predominately flushometer type water closets or syphon jet urinals.

FT means predominately flush tank type water closets or wash down urinals.

NP means not permitted, velocities exceed 8 feet per second.

For using this table, round the calculated pressure loss due to friction

to the next higher number shown.

Comm 82.40 (7) (f) and (g) specifies minimum sizes for water distribution piping.

Table 82.40-11
MAXIMUM ALLOWABLE LOAD FOR POLYETHYLENE ALUMINUM POLYETHYLENE TUBING (PexAlPex), ASTM F1281; (C=150)

Pressure Loss Due to Friction (in lbs. per 100 ft. of Length)	Pipe Diameter (in inches)											
	1/2"			5/8"			3/4"			1"		
	GPM	WSFU FM	FT	GPM	WSFU FM	FT	GPM	WSFU FM	FT	GPM	WSFU FM	FT
0.5	0.5	-	0.5	1.0	-	1.0	2.0	-	2.0	4.0	-	4.0
1	0.5	-	0.5	1.5	-	1.5	3.0	-	3.0	6.0	-	7.0
2	1.0	-	1.0	2.0	-	2.0	4.5	-	5.0	8.5	-	10.5
3	1.5	-	1.5	3.0	-	3.0	5.5	-	6.5	10.5	4.0	14.0
4	1.5	-	1.5	3.5	-	3.5	6.5	-	8.0	12.5	4.5	17.5
5	2.0	-	2.0	4.0	-	4.0	7.0	-	9.0	14.0	4.5	20.0
6	2.0	-	2.0	4.0	-	4.0	8.0	-	10.0	15.5	5.0	22.5
7	2.5	-	2.5	4.5	-	5.0	8.5	-	10.5	17.0	5.5	25.0
8	2.5	-	2.5	5.0	-	6.0	9.5	-	12.5	18.0	6.0	26.5
9	2.5	-	2.5	5.5	-	6.5	10.0	4.0	13.0	19.5	6.5	29.0
10	3.0	-	3.0	5.5	-	6.5	10.5	4.0	14.0	20.5	6.5	31.0
11	3.0	-	3.0	6.0	-	7.0	11.0	4.0	15.0	20.5	6.5	32.0
12	3.0	-	3.0	6.0	-	7.0	11.5	4.0	15.5	NP	NP	NP
13	3.5	-	3.5	6.5	-	8.0	12.5	4.5	17.5	NP	NP	NP
14	3.5	-	3.5	7.0	-	9.0	NP	NP	NP	NP	NP	NP
15	3.5	-	3.5	7.0	-	9.0	NP	NP	NP	NP	NP	NP
16	3.5	-	3.5	7.5	-	9.5	NP	NP	NP	NP	NP	NP
17	4.0	-	4.0	NP	-	NP	NP	NP	NP	NP	NP	NP
18	4.0	-	4.0	NP	-	NP	NP	NP	NP	NP	NP	NP
19	4.0	-	4.0	NP	-	NP	NP	NP	NP	NP	NP	NP
20	4.0	-	4.0	NP	-	NP	NP	NP	NP	NP	NP	NP
21	4.5	-	5.0	NP	-	NP	NP	NP	NP	NP	NP	NP

Note: WSFU means water supply fixture units.
 GPM means gallons per minute.
 FM means predominately flushometer type water closets or syphon jet urinals.
 FT means predominately flush tank type water closets or wash down urinals.
 NP means not permitted, velocities exceed 8 feet per second.
 For using this table, round the calculated pressure loss due to friction to the next higher number shown.
 Comm 82.40 (7) (f) and (g) specifies minimum sizes for water distribution piping.

Comm 82.41 Cross connection control. (1) SCOPE.

The provisions of this section set forth the requirements for the protection of potable water within water supply systems when and where there is the possibility of contamination due to cross connections or backflow conditions.

Note: The Department of Natural Resources governs the operation and design of community water systems and under s. NR 811.09 requires the supplier of water to develop and implement a comprehensive cross connection control program.

(2) MATERIALS. (a) All devices, assemblies and mechanisms intended to protect water supplies relative to cross connection or backflow shall be of a type recognized and approved in accordance with ch. Comm 84 and as described in sub. (4).

(b) All methods including barometric loops and air gaps intended to protect water supplies relative to cross connection or backflow shall be constructed of materials suitable for water sup-

ply systems in accordance with ch. Comm 84.

(3) GENERAL REQUIREMENTS. Water supply systems and the connection of each plumbing fixture, piece of equipment, appliance or nonpotable water piping system shall be designed, installed and maintained in such a manner to prevent the contamination of water supplies by means of cross connections.

(a) *Types of cross connection control.* 1. Water supply systems shall be protected against contamination due to cross connections or backflow conditions by one of the methods or devices specified in Table 82.41-1 depending upon the situation or Table 82.41-2 depending upon the specific application or use, and the limitations specified in sub. (4).

2. For the situations described in par. (b) 3., cross connection control shall be provided as part of the fixture fitting outlet or in the water supply piping for the fixture fitting outlet.

Table 82.41-1

ACCEPTABLE CROSS CONNECTION CONTROL METHODS, DEVICES OR ASSEMBLIES

Methods or Assemblies of Cross Connection Control (Standard)	Situations and Conditions							
	Backpressure				Backsiphonage			
	Low Hazard		High Hazard		Low Hazard		High Hazard	
	Contin- ous Pressure	Noncon- tinuous	Contin- ous Pressure	Noncon- tinuous	Contin- ous Pressure	Noncon- tinuous	Contin- ous Pressure	Noncon- tinuous
Air-gap Fittings for use with Plumbing Fixtures, Appliances, and Appurtenances (ASME A112.1.3)					X	X	X	X
Air Gaps (ASME A112.1.2)	X	X	X	X	X	X	X	X
Atmospheric Vacuum Breaker (CAN/CSA B64.1.1)						X		X
Backflow Preventers with Intermediate Atmospheric Vent (ASSE 1012)	X	X			X	X		
Barometric Loops					X	X	X	X
Dual Check Valve Type with Atmospheric Port Backflow Preventer (CAN/CSA B64.3)	X	X			X	X		
Hose Connection Backflow Preventers (ASSE 1052)	X ^a	X	X ^a	X	X ^a	X	X ^a	X
Hose Connection Vacuum Breakers (CAN/CSA B64.2 and B64.2.2)	X ^a	X	X ^a	X	X ^a	X	X ^a	X
Hose Connection Vacuum Breakers (ASSE 1011)	X ^a	X	X ^a	X	X ^a	X	X ^a	X
Pipe Applied Atmospheric Type Vacuum Breakers (ASSE 1001)						X		X
Pressure Vacuum Breaker Assembly (ASSE 1020)					X	X	X	X
Reduced Pressure Principle Backflow Preventers And Reduced Pressure Fire Protection Principle Backflow Preventers (ASSE 1013)	X	X	X	X	X	X	X	X
Reduced Pressure Principle Backflow Preventer (CAN/CSA B64.4)	X	X	X	X	X	X	X	X

Table 82.41-1 (Continued)

ACCEPTABLE CROSS CONNECTION CONTROL METHODS OR ASSEMBLIES FOR SPECIFIC APPLICATIONS

Methods or Assemblies of Cross Connection Control (Standard)	Situations and Conditions							
	Backpressure				Backsiphonage			
	Low Hazard		High Hazard		Low Hazard		High Hazard	
	Contin- uous Pressure	Noncon- tinuous Pressure	Contin- uous Pressure	Noncon- tinuous Pressure	Contin- uous Pressure	Noncon- tinuous Pressure	Contin- uous Pressure	Noncon- tinuous Pressure
Spill Resistant Vacuum Breaker (ASSE 1056 and CAN/CSA B64.1.3)					X	X	X	X
Vacuum Breaker (CAN/CSA B64.1.2)					X	X	X	X

^a See limitation listed under s. Comm 82.41 (4) (c) 1. a.

Table 82.41-2

ACCEPTABLE CROSS CONNECTION CONTROL METHODS, DEVICES OR ASSEMBLIES FOR SPECIFIC APPLICATIONS

Methods or Assemblies (Standard)	Types of Application or Use
Backflow Preventer for Carbonated Beverage Machines (ASSE 1022)	Beverage dispensers
Chemical Dispensing Systems (ASSE 1055)	Chemical dispensing systems
Double Check Backflow Prevention Assemblies and Double Check Fire Protection Backflow Prevention Assemblies (ASSE 1015)	Automatic fire sprinkler systems and standpipe systems Water-based fire protection system
Double Check Detector Fire Protection Backflow Prevention Assemblies (ASSE 1048)	Automatic fire sprinkler systems and standpipe systems Water-based fire protection system
Double Check Detector Valve Type Backflow Preventer (CAN/CSA B64.5)	Automatic fire sprinkler systems and standpipe systems Water-based fire protection system
Dual Check Backflow Preventer Wall Hydrant — Freeze Resistant Type (ASSE 1053)	Hose threaded outlet connection
Hand Held Showers (ASSE 1014)	Hand held shower assemblies
Laboratory Faucet Backflow Preventer (ASSE 1035)	Laboratory faucets
Laboratory Faucet Type Vacuum Breakers (CAN/CSA B64.7)	Laboratory faucets
Laboratory Faucet Vacuum Breakers (ASSE 1035)	Laboratory faucets
Pressurized Flushing Devices (Flushometers) For Plumbing Fixtures (ASSE 1037)	Flushometer plumbing fixtures
Reduced Pressure Detector Fire Prevention Backflow Preven- tion Assemblies (ASSE 1047)	Automatic fire sprinkler systems
Trap Seal Primer Valves, Water Supply Fed (ASSE 1018)	Traps for drain systems
Vacuum Breaker Tees [s. Comm 82.41 (5) (j)]	Water treatment devices
Wall Hydrants, Frost Proof Automatic Draining Anti- Backflow Type (ASSE 1019), types A or B	Hose threaded outlet connections
Water Closet Flush Tank Ball Cocks (ASSE 1002)	Gravity water closet flush tanks

(b) *Classifications.* For the purposes of this section:

1. The designation of a high hazard or low hazard situation shall be determined on the basis of how a toxic or nontoxic solution is intended or recommended by the manufacturer of the solution to interface with the potable water supply system.

2. a. A continuous pressure situation shall be considered to exist when a pressure greater than atmospheric within the water supply system exists for more than 12 continuous hours.

b. A noncontinuous pressure situation shall be considered to exist if the conditions in subd. 2. a. do not occur.

3. A high hazard cross connection situation shall be considered to exist for a connection of the water supply system to:

a. Any part of the drain system; and

b. Any other piping system conveying water from nonpotable sources, including but not limited to lakes, rivers, streams or creeks.

4. Except as provided in subd. 5., a high hazard cross connection situation shall be considered to exist at:

a. A water supply hose bibb, faucet, wall hydrant, sill cock or other outlet which terminates with hose threads allowing a hose to be attached;

b. A water supply faucet, wall hydrant or other outlet which terminates with a serrated nipple allowing a hose to be attached;

c. A water supply faucet, hydrant or outlet serving a sink used for building maintenance in a public building;

d. A chemical pot-feeder or automatic chemical feeder is installed to serve a boiler, cooling tower or chilled water system; and

e. In the water supply piping connecting to the outlet of a fire hydrant for any purpose other than fire suppression.

5. A cross connection shall not be considered to exist at the hose threaded outlet installed for the sole purpose of:

a. Draining a water supply system or any portion thereof;

b. Obtaining water quality samples of the water supply system or any portion thereof; or

c. Connecting individual residential automatic clothes washers.

6. a. A high hazard situation shall be considered to exist for the connection of 2 water supply systems one supplied by a public water supply and the other system supplied by a private well.

Note: The interconnection of a public water supply system and another source of water is addressed in s. NR 811.09 and must be approved by the Department of Natural Resources.

b. Except as provided in subd. 7., a low hazard situation shall be considered to exist for the connection of a piping system, including but not limited to automatic fire sprinkler systems, standpipe systems, and processing purposes, which provides potable water for nonrequired potable water uses.

Note: Cross connection control devices used in conjunction with automatic fire sprinkler systems are to be listed by an acceptable testing agency for such an application under the standards governing the design and installation of automatic fire sprinkler systems.

7. A cross connection situation shall not be considered to exist when a multipurpose piping system serves a one- or 2- family dwelling provided the sprinkler system is constructed of materials and joints suitable for water distribution systems as specified in ss. Comm 84.30 (4) (e) and 84.40, respectively.

(c) *Containment.* 1. For sewerage treatment facilities which are required to conform with ch. NR 110, in addition to the cross connection control required for each potable water usage or water outlet, a reduced pressure principle backflow preventer shall be installed:

a. In the water service to each building or structure within the complex;

b. In the private water main upstream of all water services serving the facility; or

c. In the water distribution system upstream of all water outlets and in the process piping network upstream of all points of

use, if both a water distribution system and a process network is contained within the same building or structure.

2. For marinas, wharves and docks where potable water outlets are provided to serve boats or ships, in addition to the cross connection control required for each potable water outlet or usage, a reduced pressure principle backflow preventer shall be installed in the water supply system to limit backflow into the water supply source.

3. The installation of a cross connection control device in the water supply system for a building or structure shall not alleviate the requirement to provide cross connection control for the connection of each plumbing fixture, piece of equipment, appliance or other piping system.

(d) *Prohibitions.* The use of a toxic solution as a heat transfer fluid in single-wall heat exchanger for potable water is prohibited.

(e) *Existing automatic fire sprinkler systems.* An alteration, modification or addition to an existing automatic fire sprinkler shall necessitate conformance with this section, if the:

1. Existing water supply line to the existing sprinkler system is increased in diameter; or

2. Existing device or method which had been previously recognized to address cross connection concerns is to be removed or replaced.

(4) *LIMITATIONS.* (a) Cross connection control devices shall be limited in use in accordance with the respective standard, unless otherwise specifically permitted under this subsection.

(b) 1. Except for a deck-mounted device, a pipe applied atmospheric vacuum breaker shall be installed such that the bottom of the device or the critical level mark on the device is at least 6" above all of the following:

a. The flood level rim of the receptor serving the water supply port.

b. The highest point downstream from the device where backpressure would be created.

c. The highest point of an injection or aspiration port.

2. A deck-mounted pipe applied atmospheric type vacuum breaker shall be installed such that the bottom of the device or the critical level mark on the device is at least one inch above all of the following:

a. The flood level rim of the receptor serving the water supply port.

b. The highest point downstream from the device where backpressure would be created.

c. The highest point of an injection or aspiration port.

(c) 1. a. The use of a hose connection backflow preventer, dual check backflow preventer wall hydrant-freeze resistant or a hose connection vacuum breaker in a continuous pressure situation shall be limited to campgrounds and marinas.

b. The use of a hose connection backflow preventer and a hose connection vacuum breaker shall be limited to the discharge side of a control valve such as a faucet or hose bibb.

2. A hose connection backflow preventer and a hose connection vacuum breaker may not be employed in backpressure situations of more than 10 feet of water column.

(d) A backflow preventer with intermediate atmospheric vent:

1. May not be employed in backpressure situations of more than 150 psig; and

2. May not serve boilers having a maximum steam pressure setting greater than 15 psig or a maximum water pressure setting greater than 30 psig.

(e) 1. A reduced pressure principle backflow preventer and a reduced pressure detector backflow preventer may not be subjected to a backpressure greater than twice the rated working pressure of the device.

2. A reduced pressure principle backflow preventer and a reduced pressure detector backflow preventer which serve a

water-based fire protection system may have a test outlet located between the number 2 check valve and the number 2 listed indicating control valve.

3. A reduced pressure principle backflow preventer and a reduced pressure detector backflow preventer which are 2" or smaller in size and which serve a water-based fire protection system are not required to have a test cock on the number one listed indicating control valve.

(f) A hand-held shower may not be employed in backpressure situations of more than 5 feet of water column.

(g) 1. A double check backflow prevention assembly and a double check detector assembly backflow preventer may not be subjected to a backpressure greater than twice the rated working pressure of the device.

2. A double check backflow prevention assembly and a double check detector assembly backflow preventer which serve a water-based fire protection system may have a test outlet located between the number 2 check valve and the number 2 listed indicating control valve.

3. A double check backflow prevention assembly and a double check detector assembly backflow preventer which are 2" or smaller in size and which serve a water-based fire protection system are not required to have a test cock on the number one listed indicating control valve.

(h) A water supply fed trap seal primer valve shall be installed such that the bottom of the device or the critical level as marked on the device is at least 12" above:

1. The connection to the trap; and
2. The highest point downstream from the device where backpressure would be created.

(i) A vacuum breaker wall hydrant, freeze resistant automatic draining type or a freeze resistant sanitary yard hydrant, may not be employed in backpressure situations of more than 10 feet of water column.

(k) 1. A pressure type vacuum breaker assembly shall be installed such that the bottom of the device or the critical level mark on the device is at least 12" above all of the following:

- a. The flood level rim of the receptor serving the water supply port.
- b. The highest point downstream from the device where backpressure would be created.
- c. The highest point of an injection or aspiration port.
2. A pressure vacuum breaker assembly shall be located only outside.

(L) A laboratory faucet backflow preventer may not be employed in backpressure situations of more than 6 feet of water column.

(m) The cross connection control device to serve a hose bibb or hydrant that penetrates an exterior wall of a heated structure may not prevent a hose bibb or hydrant from being freeze resistant automatic draining as required under s. Comm 82.40 (8) (a).

(n) A spill resistant vacuum breaker shall be installed so that the bottom of the device or the critical level mark on the device is at least 12" above all of the following:

1. The flood level rim of the receptor serving the water supply port.
2. The highest point downstream from the device where backpressure would be created.
3. The highest point of an injection or aspiration port.

(5) INSTALLATION. (a) An air gap for cross connection control shall conform to ASME A112.1.2.

Note: See Appendix for further explanatory material.

(b) Cross connection control methods, devices and assemblies shall be installed in accordance with the manufacturer's written installation specifications and this chapter. The methods, devices and assemblies shall be accessible for inspection, testing, maintenance and replacement.

Note: See s. Comm 84.30 (S).

(c) Cross connection control devices shall be protected from freezing.

(d) 1. A cross connection control device may not be located in uninhabitable spaces susceptible to flooding.

2. A cross connection control device which has one or more vent ports may not be located in a pit, vault or depression which is below the adjacent grade or floor level, even if the pit, vault or depression is provided with a drain at the bottom of the pit.

(e) 1. Vent ports of cross connection control devices shall be positioned:

- a. Away from areas where toxic gases and fumes may accumulate;
- b. Downward or protected to protect the ports from falling debris; and
- c. So as to drain dry.

2. Cross connection control devices or assemblies shall be so located that any vent ports are provided with an air gap so as to comply with ASME A112.1.2 or ASME A112.1.3.

3. a. If a reduced pressure principle backflow preventer or a reduced pressure detector backflow preventer is located within a building, a drain or receptor shall be provided to receive the discharge from the vent ports of the device. If a floor drain is to receive the discharge from the vent ports of a reduced pressure principle backflow preventer or a reduced pressure detector backflow preventer, the flow or pathway of the discharge may not create a nuisance.

b. Where drain piping is provided for the discharge from a vent port, an air gap in accordance with par. (a) shall be provided between the vent port and the drain piping.

c. Where a receptor is provided for the discharge from a vent port, an air gap in accordance with par. (a) shall be provided between the vent port and the receptor.

(f) The installation of a reduced pressure principle backflow preventer, a reduced pressure fire protection principle backflow preventer, a reduced pressure detector backflow preventer, a reduced pressure detector fire protection backflow prevention assembly, a double check backflow prevention assembly, a double check detector assembly backflow preventer, a pressure vacuum breaker assembly and a spill resistant vacuum beaker shall conform to all of the following limitations:

1. The minimum distance between the floor, surface or platform which is to provide access and the lowest point of the assembly may not be less than 12".
2. The maximum distance between the floor, surface or platform which is to provide access and the lowest point of the assembly may not be more than 7 feet.
3. The minimum distance between a ceiling or other obstruction and the highest point of the assembly may not be less than 18".
4. The minimum distance between a wall or other obstruction and the back and ends of the assembly may not be less than 4".
5. The minimum distance between a wall or other obstruction and the front of the assembly may not be less than 24".

Note: See Appendix for further explanatory material.

(g) The discharge outlet of local waste piping serving a cross connection control device shall be visible and not be located within a concealed space.

(h) No control valve may be placed downstream from a pipe applied atmospheric type vacuum breaker or a laboratory faucet backflow preventer.

(i) A barometric loop to provide cross connection control for backsiphonage shall be formed by creating a loop in the potable water supply piping upstream to the source of cross connection.

1. The loop shall extend at least 35 feet above:
 - a. The highest point downstream from the loop where backpressure would be created; and

- b. The point of discharge.
2. No outlets for potable water use shall be installed downstream of the peak of the loop.
- (j) Vacuum breaker tees shall be assembled such that:
1. The bottom of the horizontal portion of the tee is installed at least one inch above the flood level rim of the receptor;
 2. The inside diameter of the tee is equal to or greater than the inside diameter of the drain piping from the water treatment device;
 3. The tee is installed in such a position that the discharge will not create a nuisance;
 4. The piping upstream of the tee is of a type suitable for water distribution in accordance with s. Comm 84.30 (4) (e).
 5. The vent portion of the tee is equal to or greater than the inside diameter of the drain piping from the water treatment device; and
 6. The vent port of the tee is:
 - a. Positioned away from areas where toxic gases and fumes may accumulate; and
 - b. Constructed to protect the port from falling debris.
- (k) A chemical dispensing system shall be connected to the water distribution system in either of the following manners:
1. The fixture supply shall be individually connected to the water distribution system.
 2. The fixture supply shall be installed with a pressure bleeding device. The pressure bleeding device shall create a visually free flow of water through the atmosphere from the faucet connection into the fixture drain.

(6) MAINTENANCE AND TESTING. All cross connection control devices shall be maintained and tested in accordance with s. Comm 82.22 (9).

History: 1-2-56; r. (2) through (7), Register, October, 1971, No. 190, eff. 11-1-71; r. and recr. Register, November, 1972, No. 203, eff. 12-1-72; renun. from H 62.14, Register, July, 1983, No. 331, eff. 8-1-83; renun. from ILHR 82.14 and am. (1) (h) 17., r. (2), Register, February, 1985, No. 350, eff. 3-1-85; r. and recr. Register, February, 1994, No. 458, eff. 3-1-94; am. (2) (a), Tables 82.41-1, 2, (4) (c), (e) to (j), (k) to (m), (5) (e) 3. a., (j), cr. (4) (n), r. and recr. (5) (b), (f), r. (5) (h), Register, February, 1997, No. 494, eff. 3-1-97; correction in (4) (n) made under s. 13.93 (2m) (b) 1., Stats., Register, February, 2000, No. 530; am. (3) (a) 2., (4) (k) 1. and (5) (a), r. and recr. (4) (b) and (n), and Tables 82.41-1 and 82.41-2, cr. (4) (k) 1. c. and (5) (L), Register, December, 2000, No. 540, eff. 1-1-01; CR 02-002; am. (3) (intro.), (5) (a), Tables 82.41-1 and 2, renun. (5) (j) to (L) to be (5) (h) to (k) Register April 2003 No. 568, eff. 5-1-03; CR 04-035; cr. (3) (b) 4. d., am. Tables 82.41-1 and -2, 82.41 (2), (3) (a) 1. and (b) 7. Register November 2004 No. 587, eff. 12-1-04; CR 08-055; cr. (3) (b) 4. e., am. (4) (e) 1. a., (f), (i), (n), (5) (a), (e) 2., (f) (intro.), Tables 82.41-1 and 82.41-2 Register February 2009 No. 638, eff. 3-1-09; corrections in (6) made under s. 13.92 (4) (b) 1. and 7., Stats., Register February 2009 No. 638.

Subchapter V — Special Plumbing Installations

Comm 82.50 Health care and related facilities.

(1) GENERAL. The provisions of this section shall set forth the requirements for the design, installation and maintenance of devices, fixtures and equipment which are installed in health care and related facilities.

(2) FIXTURES AND EQUIPMENT. (a) *Special fixtures and equipment.* 1. 'Requirements for ice manufacture and storage.' Machines for manufacturing ice or any device for handling or storage of ice shall be located in an area not subject to contamination.

2. 'Sterilizers and washer sanitizers.' a. Sterilizers and washer sanitizers shall discharge by means of indirect waste.

b. The indirect waste piping shall discharge by means of air-gap.

3. 'Aspirators.' Aspirators which require the use of water shall be provided with approved cross connection control.

(b) *Spouts and actions.* The selection of spouts and actions on plumbing fixtures shall comply with this section and Table 82.50-1.

1. 'Spouts'. Lavatories and sinks accessible to patients shall have the water supply spout mounted so that its discharge point is a minimum distance of 5" above the flood level rim of the fixture.

2. 'Actions.' All fixtures used by medical and nursing staff, and all lavatories used by patients and food handlers shall be equipped with valves that can be operated without the use of hands. Where wrist blade handles are used for this purpose, the handles shall not exceed 4 1/2" in length, except handles on scrub sinks and clinical sinks shall be no less than 6" long.

(c) *Floor drain prohibition.* 1. Except as provided in subd. 2., floor drains may not be installed in operating or delivery rooms.

2. Floor drains may be installed in cystoscopic rooms. The drain shall contain a non-splash, horizontal-flow flushing bowl beneath the drain plate.

(3) WATER SUPPLY SYSTEMS. (a) *Hospital water supply systems.* Water supply systems serving hospitals shall comply with all of the following:

1. All hospitals shall be provided with at least 2 water services. Whenever more than one water main is available, the connections shall be made to different water mains.

2. Each water service connection shall adequately serve the total building water supply demand as specified in s. Comm 82.40 (7).

Note: The installation of two water services or a private water main may require the installation of a check valve. Refer to ch. NR 811 for more information.

(b) *Hospital, community-based residential facility, inpatient hospice and nursing home water supply systems.* 1. Water supply systems serving a hospital, community-based residential facility, inpatient hospice or nursing home shall comply with all of the following:

a. Except as provided in subd. 1. b., a single control valve may serve an area where 4 or fewer patient care units exist and where each unit contains not more than 2 persons.

b. A water supply serving an intensive care patient care unit shall be individually valved.

2. All water distribution piping shall be insulated in accordance with chs. Comm 60 to 66.

3. Cold water shall be supplied to lavatories or sinks located in patient rooms.

4. A hot water distribution system shall be under constant recirculation to provide continuous hot water at each hot water outlet, except that uncirculated hot water distribution piping may not exceed 25 feet in developed length.

5. Water provided to patient showers, therapeutic equipment and all types of baths shall be installed with control valves which automatically regulate the temperature of the water supply to the fixture fitting outlet within a temperature range of 110°F to 115°F. Such control valves shall automatically reduce flow to 0.5 gpm or less when the water supply to the fitting outlet exceeds 115°F or when loss of cold water pressure occurs.

Note: See Appendix A-82.50 (3) (b) 5. for sketches showing various design options.

6. Hot water distribution systems shall be installed and maintained to provide bacterial control by one of the following methods:

a. Water stored and circulation initiated at a minimum of 140°F and with a return of a minimum of 124°F.

b. Water chlorinated at 2 mg/L residual.

Note: Additional information may be contained in ASHRAE Guideline 12-2000, Minimizing the Risk of Legionellosis Associated with Building Water Systems. This standard is published by the American Society of Heating, Refrigerating and Air-Conditioning Engineers (ASHRAE); 1791 Tullie Circle, N.E., Atlanta, GA 30329, phone: (800) 5-ASHRAE or (404) 636-8400 ext. 507; fax: (404) 321-5478; e-mail: orders@ashrae.org; or online at www.ashrae.org.

c. Another disinfection system approved by the department.

7. A water distribution system may not be designed, installed and maintained so that the maximum temperature to fixture fitting outlets accessible to patients exceeds 115°F.

Note: See s. Comm 82.40 (5) and ch. DHS 124 for additional requirements for circulation systems.

8. Except as provided in subd. 7., a water distribution system may not be designed, installed and maintained so that the maximum temperature to fixture fitting outlets exceeds 180°F.

**TABLE 82.50-1
SPOUTS AND ACTIONS REQUIRED IN HEALTH CARE AND RELATED FACILITIES**

Fixture Location	Type of Spout		Type of Action		
	Standard	Gooseneck or provide a 5-inch clearance	Hand	Wrist	Foot, Knee or Electronic Sensor
NURSING DEPARTMENT					
Patient toilet room		X		X	X
Patient toilet room, isolation		X			X
Utility room		X		X	X
Treatment room		X		X	X
Medicine room		X		X	X
Kitchen floor lavatory		X		X	X
Kitchen floor sink	X	X		X	X
Nurses toilet room	X	X	X	X	X
Floor laboratory		X	X	X	X
NURSERY					
Nursery		X		X	X
Exam/treatment room		X		X	X
Infant intensive care unit		X			X
Labor room		X		X	X
SURGICAL					
Scrub room		X ^a			X
Sub-sterile room	X	X		X	X
Clean-up room	X	X		X	X
Frozen sections room		X	X	X	X
Surgical supply room		X		X	X
Work room	X	X		X	X
Cystoscopic room		X ^a		X	X
Fracture room	X	X		X	X
Recovery room		X			X
CENTRAL SUPPLY					
Work room	X	X		X	X
Solutions room	X	X		X	X
Pharmacy		X	X	X	X
Manufacturing		X		X	X
EMERGENCY DEPARTMENT					
Observation bedroom		X		X	X
Utility room		X		X	X
Operating room		X ^a			X
Exam room		X		X	X
DIAGNOSTIC AND TREATMENT					
Occupational therapy room		X		X	X
Hydro-therapy room		X		X	X
Exam/treatment room		X		X	X
Radium treatment/exam room		X		X	X
Toilet room		X		X	X
Dark room		X		X	X
Autopsy room		X ^a			X
Lavatory in autopsy shower room		X	X	X	X
Laboratory		X	X	X	X

TABLE 82.50-1 (Continued)
SPOUTS AND ACTIONS REQUIRED IN HEALTH CARE AND RELATED FACILITIES

Fixture Location	Type of Spout		Type of Action		
	Standard	Gooseneck or provide a 5-inch clearance	Hand	Wrist	Foot, Knee or Electronic Sensor
CLINIC OR OUTPATIENT DEPARTMENT					
Exam/treatment room		X		X	X
Dental operating room		X			X
Dental laboratory		X	X	X	X
Dental recovery room		X		X	X
Surgical room		X ^a			X
Eye exam room		X			X
Ear, nose and throat exam room		X			X
SERVICE DEPARTMENT					
Lavatory in kitchen	X	X		X	X

X = Spout and action meet required type.

^a Spout includes a spray head.

History: 1-2-56; am. (3) (4) and (5), Register, August, 1961, No. 68, eff. 9-1-61; r. and recr. Register, November, 1972, No. 203, eff. 12-1-72; r. and recr., Register, February, 1979, No. 278, eff. 3-1-79; renun. from H 62.16, Register, July, 1983, No. 331, eff. 8-1-83; renun. from ILHR 82.16 and am. (7) (b), (10) (a) 1. and 2., (b) 2., (f) (intro.) and (h), Register, February, 1985, No. 350, eff. 3-1-85; r. (10) (f) and Table 25, Register, February, 1994, No. 458, eff. 3-1-94; correction in (7) (b) made under s. 13.93 (2m) (b) 7., Stats., Register, July, 2000, No. 535; am. (2) and (10) (g) Table 26, r. and recr. (10) (g) and (h), r. (10) (i), Register, December, 2000, No. 540, eff. 1-1-01; CR 02-002: r. and recr. Register April 2003 No. 568, eff. 5-1-03; CR 04-035: am. Table 82.50-1 and (3) (b) 5. Register November 2004 No. 587, eff. 12-1-04; correction in (3) (b) 2. made under s. 13.92 (4) (b) 7., Stats., Register February 2008 No. 626; CR 08-055: am. (3) (b) 5. Register February 2009 No. 638, eff. 3-1-09.

Comm 82.51 Manufactured homes and manufactured home communities. (1) DRAIN SYSTEMS. Except as provided in pars. (a) and (b), the building sewers and private interceptor main sewers serving a manufactured home or manufactured home community shall comply with s. Comm 82.30.

(a) The minimum slope of the aboveground building sewer shall be 1/8 inch per foot.

(b) For manufactured homes, the most upstream point of the building sewer shall be determined at the connection with the building drain installed by the manufactured home manufacturer prior to delivery.

(c) The above ground building sewer shall be constructed of materials suitable for above ground drain and vent as specified in s. Comm 84.30 (2) (a).

(2) WATER SUPPLY SYSTEMS. (a) Except as provided in pars. (b) and (c), the water services and private water mains for a manufactured home or manufactured home community shall comply with s. Comm 82.40.

(b) The above ground water service shall be constructed of materials approved for water distribution as specified in s. Comm 84.30 (4) (e).

(c) The curb stop serving an individual manufactured home shall terminate outside the perimeter of the manufactured home.

(d) For manufactured homes, the most downstream point of the water service shall be determined at the connection with the water distribution piping by the manufactured home manufacturer prior to delivery.

(3) MANUFACTURED HOME CONNECTIONS. (a) Frost sleeves for plumbing serving a manufactured home shall conform to all of the following:

1. Water service and building sewer connections shall be provided with frost sleeves extending to within 6 inches of the top of the below ground horizontal building sewer or water service, or to a depth at least 6 inches below the predicted depth of frost in accordance with Table 82.30-6.

2. The frost sleeve shall terminate at least 2 inches above grade.

3. The sleeve shall be constructed of material approved for building drain or building sewer material as specified in s. Comm 84.30 (2).

(b) Termination of the water service and building sewer shall conform to all of the following:

1. The manufactured home water service for connection to the manufactured home shall terminate a minimum of 6 inches above the surrounding finished grade.

2. The manufactured home building sewer for connection to the manufactured home shall terminate a minimum of 4 inches above the surrounding finished grade and may not terminate higher than the water service.

(c) The manufactured home water service and building sewer shall be capped or plugged when not connected to a manufactured home.

Note: See Appendix A-82.51 (3) for further explanatory material.

History: Cr. Register, February, 1985, No. 350, eff. 3-1-85; r. and recr. Table, Register, August, 1991, No. 428, eff. 9-1-91; am. (2) (d), Register, February, 1994, No. 458, eff. 3-1-94; CR 02-002: r. and recr. Register April 2003 No. 568, eff. 5-1-03; CR 08-055: am. Register February 2009 No. 638, eff. 3-1-09.

Subchapter VI — Installation

Comm 82.60 Pipe hangers and supports. The provisions of this section control the types, materials and installation of anchors, hangers and supports for plumbing piping.

(1) MATERIAL. (a) **Strength.** Hangers, anchors and supports for piping shall be of sufficient strength to support the piping and its contents. Drain piping shall be considered as being full of water. Underground piers for pipe support shall be of concrete, masonry, plastic or pressure treated wood.

(b) **Compatibility.** 1. Hangers and straps shall be of a compatible material that will reduce the potential for galvanic action with the piping.

2. Hangers and straps may not distort, cut or abrade piping.

(2) INSTALLATION. (a) Piping hangers and anchors shall be securely attached to the building's structure at intervals to support the piping and its contents, but not at intervals greater than those

specified in Table 82.60. The connection of drain piping to a fixture or appliance shall be considered a point of support.

(b) Hubless pipe installed in the horizontal position shall be supported within 24" on each side of a joint, unless the joint has an alignment retaining shield.

(c) Hangers shall not be attached to a building's structure by means of wood plugs.

(d) Shower valves and piping from the shower valve to the shower head outlet shall be securely attached to the structure.

Table 82.60
SUPPORT SPACING

Material	Maximum Horizontal Spacing (feet)	Maximum Vertical Spacing (feet)
Acrylonitrile Butadiene Styrene (ABS)	4	10
Brass	10	10
Cast iron	5 ^a	15
Copper or Copper-Alloy Pipe	12	10
Copper or Copper-Alloy Tubing:		
≤ 1/4" diameter ^c	6	10
≥ 1/2" diameter ^c	10	10
Chlorinated Polyvinyl Chloride (CPVC):		
≤ 1" diameter ^c	3	5 ^b
≥ 1/4" diameter ^c	4	6 ^b
Crosslinked Polyethylene (PEX)	2 2/3	4
Ductile Iron	5 ^a	15
Galvanized Steel	12	15
Lead	Continuous	4
Polybutylene (PB)	2 ft. 8 in.	4
Polyethylene (PE)	2	4
Polypropylene (PP)	2	4
Polyvinylidene Fluoride (PVDF)	2	4
Polyvinyl Chloride, flexible (PVC)	2	4
Polyvinyl Chloride (PVC)	4	10
Stainless Steel	12	15

^a The maximum horizontal spacing for supports may be increased to 10 feet when 10-foot lengths of pipe are employed.

^b Mid-story guide is to be employed.

^c "≥" means greater than or equal to.

"≤" means less than or equal to.

History: Cr. Register, February, 1985, No. 350, eff. 3-1-85; r. and rec. Register, May, 1988, No. 389, eff. 6-1-88; r. and rec. Table 82.60, Register, February, 1994, No. 458, eff. 3-1-94; cr. (2) (d), Register, December, 2000, No. 540, eff. 1-1-01; CR 02-002: am. Table Register April 2003 No. 568, eff. 5-1-03.

Subchapter VII — Plumbing Treatment Standards

Comm 82.70 Plumbing treatment standards.

(1) **PURPOSE.** The purpose of this section is to establish plumbing treatment standards for plumbing systems that supply water to outlets based on the intended use.

(2) **SCOPE.** The provisions of this section apply to plumbing systems that supply water to outlets.

Note: For requirements and specifications for POWTS, refer to ch. Comm 83.

Note: The department of natural resources requires WPDES permits for point source discharges under ch. 283, Stats.

(3) **GENERAL REQUIREMENTS.** A plumbing system shall supply water that is of a quality that will protect public health and the waters of the state and be suitable for the intended use.

Note: Refer to s. Comm 82.34 for requirements for wastewater reuse.

(4) **MINIMUM REQUIREMENTS.** (a) Except as provided under par. (b), a plumbing system shall supply a quality of water at the outlet or at the termination of the plumbing system that meets or exceeds the minimum requirements as specified in Table 82.70-1.

(b) For an outlet other than a plumbing fixture, appliance or appurtenance, there may be more stringent requirements assigned by a municipality, governmental unit, state agency or the owner of the plumbing system.

Table 82.70-1
PLUMBING TREATMENT STANDARDS

Intended Use	Plumbing Treatment Standards ^f
1. Drinking, cooking, food processing, preparation and cleaning, pharmaceutical processing, and medical uses	NR 811 and 812 approved sources
2. Personal hygiene, bathing, and showering	NR 811 and 812 approved sources
3. Automatic fire protection systems	As acceptable by local authority
4. Swimming pool makeup water	NR 811 and 812 approved sources
5. Swimming pool fill water	DHS 172 requirements
6. Once through cooling water ^b	pH 6 - 9 ^b ≤ 30 mg/L BOD ₅ ≤ 30 mg/L TSS < 200 fecal coliform cfu/100 mL ≥ 1 mg/L and ≤ 10 mg/L free chlorine residual ^b
7. Subsurface infiltration and irrigation, using reuse as the source ^c	≤ 15 mg/L oil and grease ≤ 30 mg/L BOD ₅ ≤ 35 mg/L TSS < 200 fecal coliform cfu/100 mL ^d
8. Subsurface infiltration and irrigation, using stormwater as the source ^c	< 15 mg/L oil and grease < 60 mg/L TSS
9. Surface or spray irrigation using stormwater and clearwater as the source ^c	≤ 10 mg/L BOD ₅ ≤ 5 mg/L TSS
10. Surface irrigation except food crops, vehicle washing, toilet and urinal flushing, clothes washing, air conditioning, soil compaction, dust control, washing aggregate and making concrete ^{a, c}	pH 6 - 9 ^b ≤ 10 mg/L BOD ₅ ≤ 5 mg/L TSS No detectable fecal coliform cfu/100 mL ≥ 1 mg/L and ≤ 10 mg/L free chlorine residual ^b
11. Uses not specifically listed above	Contact department for standards

- ^a Refer to the department of agriculture, trade and consumer protection for commercial use.
- ^b Applies only to wastewater treatment devices for reuse systems. Other equivalent disinfection methods may be approved by the department.
- ^c These requirements do not apply to the treatment of industrial wastewater or other wastewater discharges that are subject to a WPDES permit issued by the department of natural resources.

- ^d A 12-inch minimum separation of medium sand or finer material above high groundwater or bedrock.
- ^f For stormwater, the plumbing treatment standards are based on an annual average. Evaluation of research to prove compliance with this table is based on the geometric mean of the data acceptable to the department or an equivalent method.

History: CR 02-002: cr. Register April 2003 No. 568, eff. 5-1-03; CR 04-035: am. Table 82.70-1 Register November 2004 No. 587, eff. 12-1-04; CR 08-055: am. Table 82.70-1 Register February 2009 No. 638, eff. 3-1-09.



Chapter Comm 82**APPENDIX**

The material contained in this appendix is for clarification purposes only. The notes, illustrations, etc., are numbered to correspond to the number of the rule as it appears in the text of the code.

A-82.20 (2) AGENT MUNICIPALITIES. The department has designated 10 municipalities the authority to review and approve plumbing plans and specifications for those plumbing installations located within the boundary limits of the municipality and that require approval under s. Comm 82.20. The cities of Appleton, Eau Claire, Green Bay, Greenfield, Janesville, Madison, Milwaukee, Oshkosh, Sheboygan and West Bend have been designated as authorized municipalities. In addition, the cities of Eau Claire, Janesville, Madison and Sheboygan perform review of stormwater infiltration system plans.

Note: The department maintains a list on its web site at <http://commerce.wi.gov/SB> that is subject to change. See also the Plumbing Program page on the Safety and Buildings Division web site at <http://commerce.wi.gov/SB/SB-PlumbingProgram.html>.

A-82.20 (4) WATER QUALITY MANAGEMENT AGENCIES (WQM.) There are 23 water quality management agencies serving the state. These agencies review proposed sewer extensions and provide Sewer Service Area Conformance letters (also know as Water Quality Management letters).

Note: The department of natural resources maintains this WQM listing and may update it periodically. See <http://www.dnr.state.wi.us/org/water/wm/glwsp/facilities/rpc.htm> for a current list of agencies and the areas that they serve.

A-82.30 (4)-1. BRANCH INTERVALS.

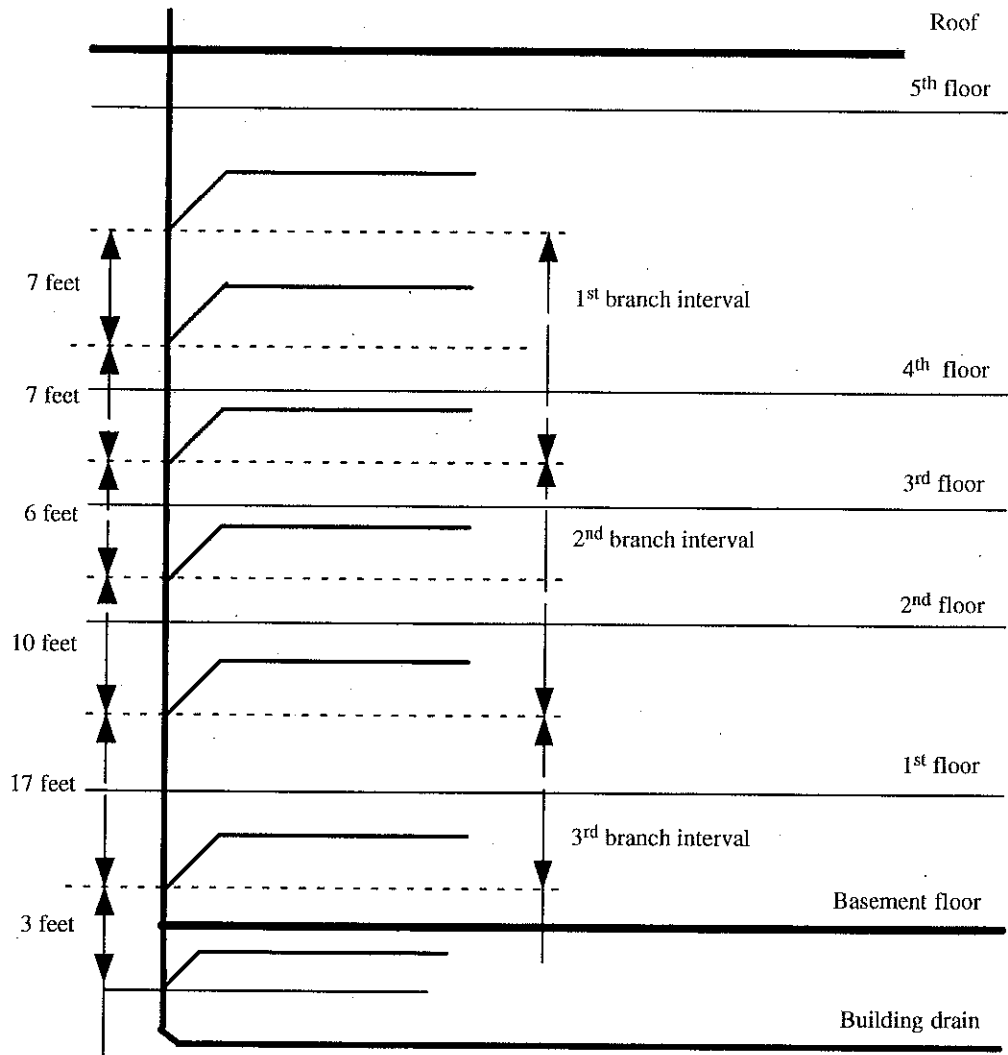

A-82.30 (4)-2. RECEPTOR DESIGN. The following table lists the gallons per minute (GPM) that can be expected to readily flow through a given size trap where the receptor has a height (H) as indicated.

Also listed is a drainage fixture unit (dfu) load that a given size receptor trap may be expected to adequately receive.

Note: A minimum individual 4 inch diameter trap and drain for a commercial type dishwasher is recommended.

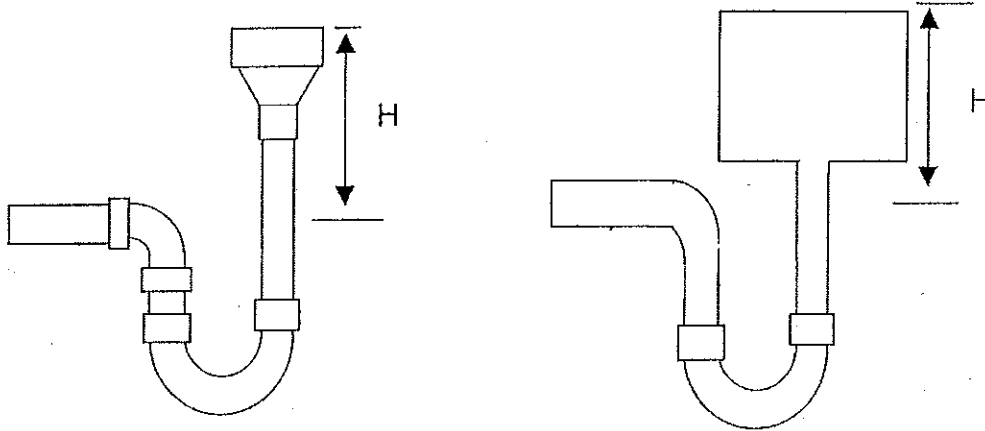

Receptor Trap Size (in inches)	H (in inches)	GPM	Drainage Fixture Units (dfu)
1½	12	4	2
2	14	8	4
3	15	12	6
4	17	40	20
5	20	70	35
6	22	120	60
8	25	250	125

A-82.30 (4)-3. SLOPE BETWEEN MANHOLES IN CONVENTIONAL GRAVITY SEWERS. Section NR 110.13 (2) (c) reads:

"Slope. 1. Conventional gravity sewers shall be laid with uniform slope between manholes. All sewers shall be designed and constructed to give average velocities of not less than 60 centimeters per second (2.0 feet per second) when flowing full. The minimum slopes in Table 1 shall be provided. Slopes less than 0.4% may be permitted for 20 centimeter (8 inch) sewers. In such cases, however, the slope may not be less than 0.3%. The department [DNR] will approve these sewers only when the owner demonstrates that physical circumstances warrant the lesser slope. Furthermore, approval will not be granted until the department [DNR] has received written assurance from the operating authority that the authority will provide the additional maintenance which may result from the sedimentation due to decreased velocities."

NR 110 Table 1

Sewer Size (in inches)	Minimum Slope (ft./100 ft.)
8 (20 cm)	0.40
10 (25 cm)	0.28
12 (30 cm)	0.22
15 (38 cm)	0.15
18 (46 cm)	0.12
21 (53 cm)	0.10
24 (61 cm)	0.08

A-82.30 (6) (b) OFFSETS IN VERTICAL DRAINS.

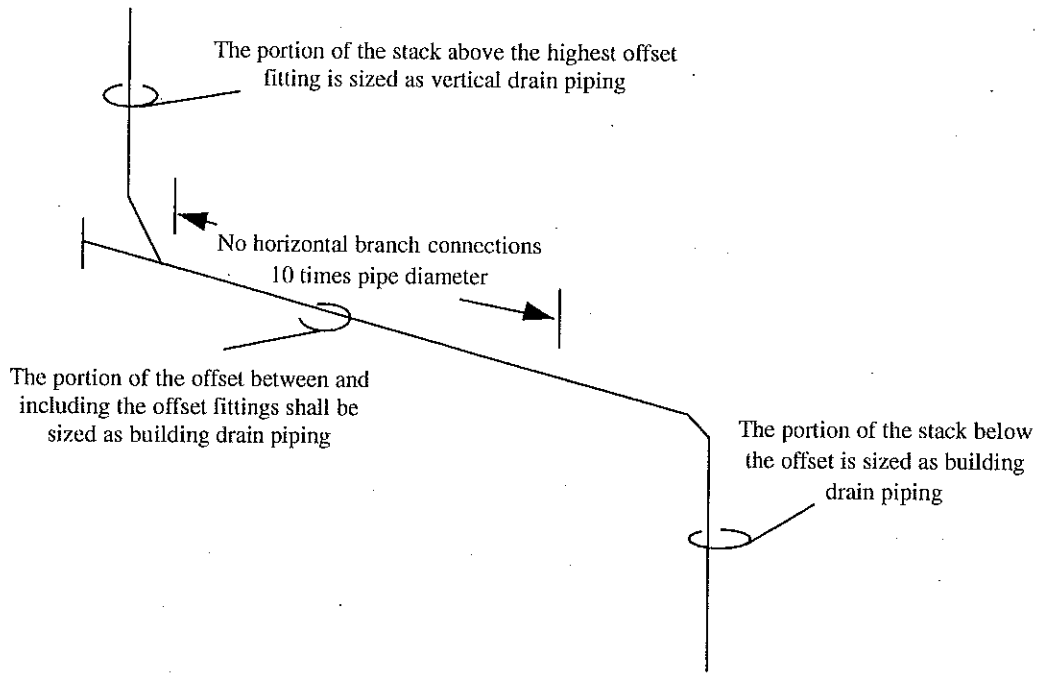

A-82.30 (7) HORIZONTAL BRANCH DRAIN CONNECTION AT BASE OF A STACK.

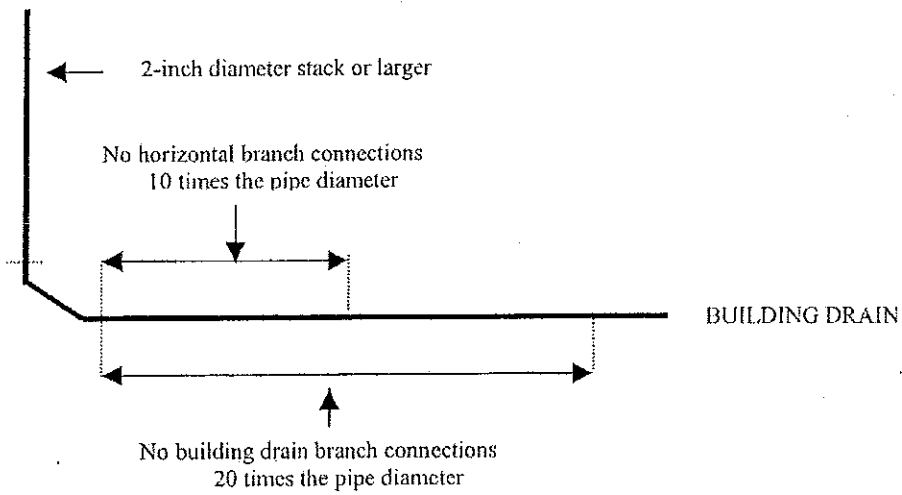

A-82.30 (8) MEASURING RADIUS OF A FITTING.

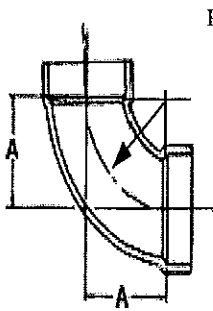

Radius of a plastic DWV fitting

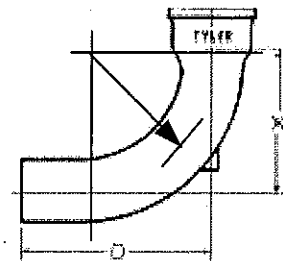

Radius of hub & spigot fitting

A-82.30 (10) (a) DETERMINING REQUIRED CAPACITY OF SANITARY SUMP.

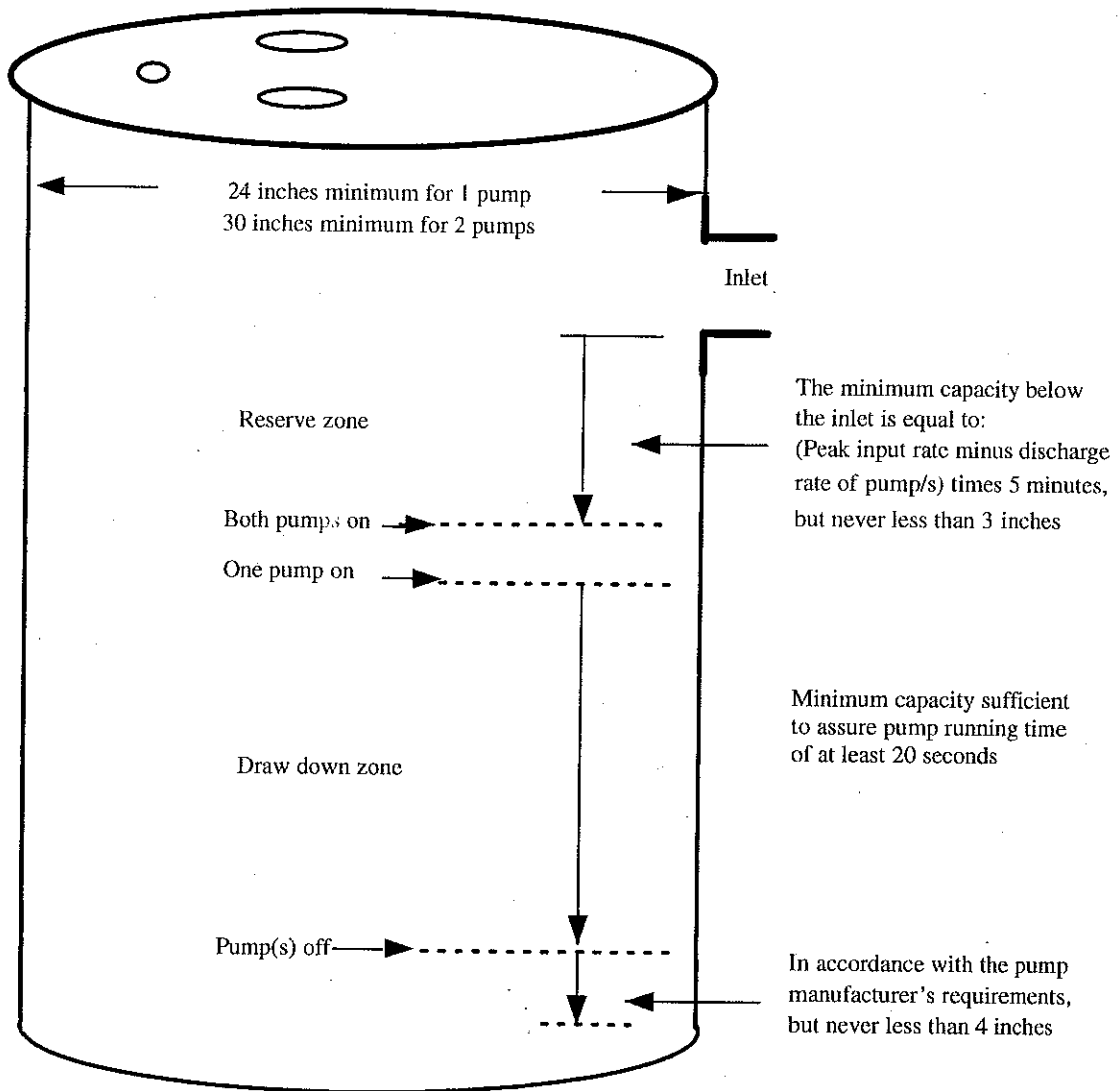

A-82.30 (10) (a) SUMPS.

Capacity of Sumps (in gallons)

Diameter of sump in inches	Volume in gal/ft	Diameter of sump in inches	Volume in gal/ft
24	23.5	41	68.6
25	25.5	42	72.1
26	27.6	43	75.5
27	29.7	44	79.1
28	32.0	45	82.7
29	34.3	46	86.5
30	36.8	47	90.2
31	39.2	48	94.0
32	41.8	54	119.0
33	44.5	60	147.0
34	47.2	66	178.0
35	50.0	72	211.5
36	52.8	78	248.4
37	55.9	84	288.1
38	59.0	90	330.8
39	62.1	96	376.3
40	65.3	108	477.3

A-82.30 (10) (b) 3. VELOCITY AND FLOW RELATIONSHIP MAINTAINING 2 FEET PER SECOND.

Schedule 40 PVC
Velocity And Flow Relationship Maintaining 2 Feet Per Second

Nominal Inside Diameter (in inches)	Actual Inside Diameter (in inches)	GPM creating 2 ft. per second
1¼	1.38	9
1½	1.61	13
2	2.067	21
3	3.068	46
4	4.026	79

A-82.30 (11) (b) BUILDING DRAINS SERVING ANY BUILDING.

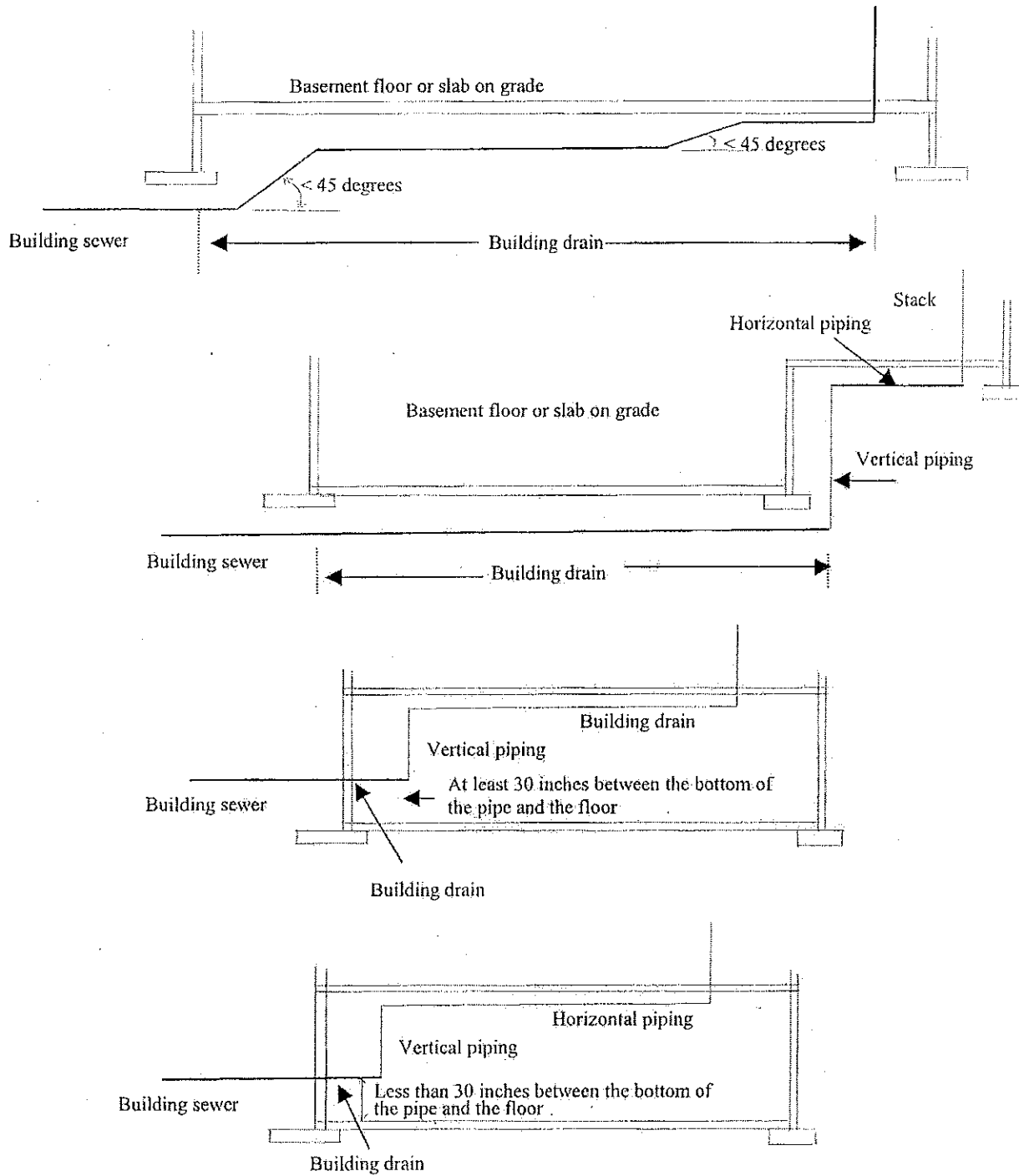

A-82.30 (11) (c) BUILDING SEWER INSULATION.

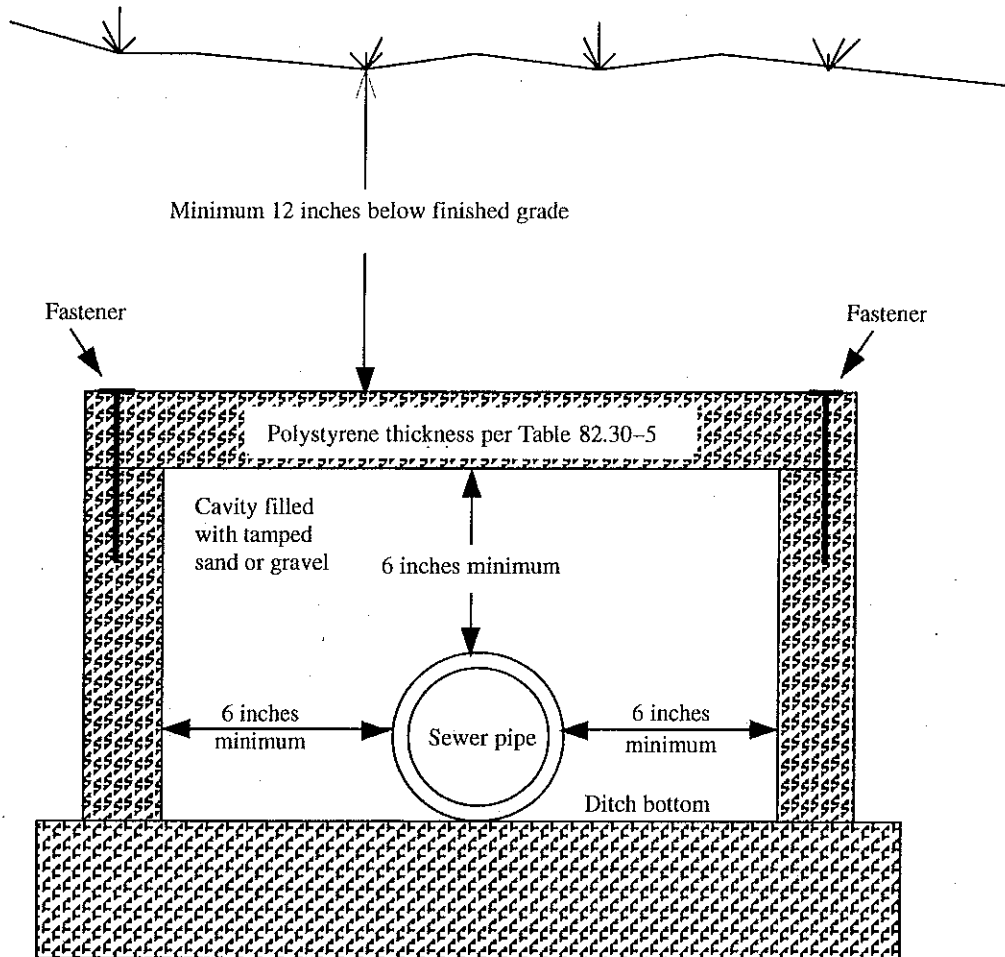

A-82.30 (11) (d) SETBACKS FOR VARIOUS CONTAMINANT SOURCES. Setbacks for various contaminant sources as specified in chs. NR 811 and NR 812 read:

NR 811.16 (4) (d) The well shall be adequately separated from potential sources of contamination. Unless a hydrogeologic investigation indicates lesser separation distances would provide adequate protection of a well from contamination, the minimum separation distances provided shall be:

1. Fifty feet between a well and a storm sewer main.
2. Two hundred feet between a well and any sanitary sewer main, sanitary sewer manhole, lift station or single family residential fuel oil tank. A lesser separation distance may be allowed for sanitary sewer mains where the sanitary sewer main is constructed of water main materials and joints and pressure tested in place to meet current AWWA C600 specifications. In no case may the separation distance between a well and a sanitary sewer main be less than 50 feet.
3. Four hundred feet between a well and a septic tank or soil adsorption unit receiving less than 8,000 gallons per day, a cemetery or a storm water drainage pond.
4. Six hundred feet between a well and any gasoline or fuel oil storage tank installation that has received written approval from the department of commerce or its designated agent under s. Comm 10.10.
5. One thousand feet between a well and land application of municipal, commercial or industrial waste; the boundaries of a landspreading facility for spreading of petroleum-contaminated soil regulated under ch. NR 718 while that facility is in operation; industrial, commercial or municipal waste water lagoons or storage structures; manure stacks or storage structures; and septic tanks or soil adsorption units receiving 8,000 gallons per day or more.
6. Twelve hundred feet between a well and any solid waste storage, transportation, transfer, incineration, air curtain destructor, processing, wood burning, one time disposal or small demolition facility; sanitary landfill; any prop-

erty with residual groundwater contamination that exceeds ch. NR 140 enforcement standards that is shown on the department's geographic information system; registry of closed remediation sites; coal storage area; salt or deicing material storage area; gasoline or fuel oil storage tanks that have not received written approval from the department of commerce or its designated agent under s. Comm 10.10; bulk fuel storage facilities; and pesticide or fertilizer handling or storage facilities.

Note: Sites that have been closed with groundwater enforcement standard exceedances can be found on the Department of Natural Resource's GIS Registry of Closed Remediation Sites, at <http://www.dnr.state.wi.us/org/aw/rf> on the DNR's internet site. Information that appears on the GIS Registry of Closed Remediation Sites can also be accessed by calling the nearest regional DNR office.

NR 812.08 Well, reservoir and spring location. (1) GENERAL. Any potable or nonpotable well or reservoir shall be located:

(a) So the well and its surroundings can be kept in a sanitary condition.

(b) At the highest point on the property consistent with the general layout and surroundings if reasonably possible, but in any case protected against surface water flow and flooding and not downslope from a contamination source on the property or on an adjacent property regardless of what was installed first, the well or the contamination source. When a contamination source is installed upslope from a well in violation of this section after the well construction has been completed, the violation is not the responsibility of the well driller, except if the well driller knew or should have known of the proposed upslope installation of the contamination source. When there is no location on the property where this requirement can be met, a well may be constructed without a variance if it is constructed with a minimum of 20 or more feet of well casing pipe than is required by ss. NR 812.12 and 812.13 and Tables I and II or with a minimum of 60 feet of well casing pipe provided that the minimum well casing pipe depth requirements of s. NR 812.12 or 812.13 and Table I or II are met. This exception does not apply to high capacity, school or wastewater treatment plant wells. A well or reservoir is located downslope from a contamination source, regardless of the presence or absence of a structure between the well and the contamination source, if:

1. The ground surface elevation at the well or reservoir is lower than the elevation at the contamination source, and
2. Surface water that washes over the contamination source would travel within 8 feet of the well or reservoir, or over the well or reservoir.

(c) As far away from any known or possible source of contamination as the general layout of the premises and the surroundings allow.

Note: Section PSC 114.234 C8 requires that a horizontal clearance of at least $\frac{3}{4}$ of the vertical clearance of the conductors, including overhead power lines to the ground required by Rule 232 shall be maintained between open conductors and wells. Persons installing wells must comply with this requirement.

(d) Such that any potential contaminant source, not identified in this section or in Table A, is a minimum of 8 feet from the well or reservoir.

(e) Every well shall be located so that it is reasonably accessible with proper equipment for cleaning, treatment, repair, testing, inspection and any other maintenance that may be necessary.

(2) RELATION TO BUILDINGS. In relation to buildings, the location of any potable or nonpotable well shall be as follows:

(a) When a well is located outside and adjacent to a building, it shall be located so that the center line of the well extended vertically will clear any projection from the building by not less than 2 feet and so that the top of the well casing pipe extends at least 12 inches above the final established ground grade.

(b) When a structure is built over a drilled well, it shall have an access hatch or removable hatch, or provide other access to allow for pulling of the pump. The well casing pipe shall extend at least 12 inches above the floor and be sealed watertight at the point where it extends through the floor.

(c) No well may be located, nor a building constructed, such that the well casing pipe will terminate in or extend through the basement of any building or terminate under the floor of a building having no basement. The top of a well casing pipe may terminate in a walkout basement meeting the criteria of s. NR 812.42 (9) (b) 1. to 4. A well may not terminate in or extend through a crawl space having a below ground grade depression or excavation.

(3) RELATION TO FLOODPLAINS. (a) A potable or nonpotable well may be constructed, reconstructed or replaced in a floodfringe provided that the top of the well is terminated at least 2 feet above the regional flood elevation for the well site.

(b) A well may be reconstructed or replaced in a floodway provided that the top of the well is terminated at least 2 feet above the regional flood elevation for the well site.

(c) A well may not be constructed on a floodway property that is either undeveloped or has building structures but no existing well.

(d) The regional flood elevation may be obtained from the department.

(4) RELATION TO CONTAMINATION SOURCES. Minimum separating distances between any new potable or nonpotable well, reservoir or spring and existing sources of contamination; or between new sources of contamination and existing potable or nonpotable wells, reservoirs or springs shall be maintained as described in this subsection. The minimum separating distances of this subsection do not apply to dewatering wells approved under s. NR 812.09 (4) (a). Greater separation distances may be required for wells requiring plan approval under s. NR 812.09. Separation distance requirements to possible sources of contamination will not be waived because of property lines. Minimum separating distances are listed in Table A and are as follows:

(a) Eight feet between a well or reservoir and a:

1. Buried gravity flow sanitary or storm building drain having pipe conforming to ch. Comm 84;
 2. Buried gravity flow sanitary or storm building sewer having pipe conforming to ch. Comm 84;
 3. Watertight clear water waste sump;
 4. Buried clear water waste drain having pipe conforming to ch. Comm 84;
 5. Buried gravity flow foundation drain;
 6. Rainwater downspout outlet;
 7. Cistern;
 8. Buried building foundation drain connected to a clear water waste drain or other subsoil drain;
 9. Noncomplying pit, subsurface pumphouse, alcove, or reservoir;
 10. Nonpotable well;
 11. Fertilizer or pesticide storage tank with a capacity of less than 1,500 gallons, but only when the well is nonpotable;
- Note: For potable wells see par. (d) 1.
12. Plastic silage storage and transfer tube;
 13. Yard hydrant;
 14. Swimming pool, measured to the nearest edge of the water; or
 15. Dog or other small pet house, animal shelter or kennel housing not more than 3 adult pets on a residential lot.

(b) Twenty-five feet between a well or reservoir and a:

1. Buried grease interceptor or trap;
2. Septic tank;
3. Holding tank;
4. Buried building drain or building sewer having pipe not conforming to ch. Comm 84, wastewater sump, or non-watertight clear water waste sumps,
5. Buried pressurized sanitary building sewer having pipe conforming to ch. Comm 84;
6. Buried gravity manure sewer;
7. Lake, river, stream, ditch or stormwater detention pond or basin measured to the regional high water elevation in the case of a lake or stormwater detention pond, to the edge of the floodway in the case of a river or stream or to the edge in the case of a ditch or stormwater detention basin;
8. Liquid-tight barn gutter;
9. Animal barn pen with concrete floor;
10. Buried pressurized sewer pipe conveying manure provided that the pipe meets ASTM specification D-2241, with standard dimension ratio of 21 or less or pressure pipe meeting the requirements of s. NR 110.13 (6) (f) or 811.62.

Note: There is no NR 110.13 (6) (f).

11. Buried fuel oil tanks serving single family residences, including any associated buried piping;
12. Discharge to ground from a water treatment device;
13. Vertical shaft installed below grade used for intake of air for a heating or air conditioning system; or
14. Buried sanitary or storm collector sewer serving 4 or fewer living units or having a diameter of 6 inches or less.
15. Soil absorption unit receiving less than 8,000 gallons/day, existing, abandoned or alternate, but not including a school soil absorption unit;

Note: For school soil absorption units see par. (e); for soil absorption units receiving more than 8,000 gallons/day see par. (f) 3.

(c) Fifty feet between a well or reservoir and a:

1. Privy;
2. Pet waste pit disposal unit;

3. Animal shelter;
4. Animal yard;
5. Silo;
6. Buried sewer used to convey manure having pipe conforming to ch. Comm 84 that does not meet the specifications in par. (b);
7. Liquid-tight manure hopper or reception tank;
8. Filter strip;
9. Buried sanitary or storm collector sewer serving more than 4 living units or larger than 6 inches in diameter except that wells may be located or sewers installed such that a well is less than 50 feet, but at least 25 feet, from gravity collector sewers smaller than 16 inches in diameter or from force main collector sewers 4 inches or smaller in diameter provided that within a 50-foot radius of the well the installed sewer pipe meets the allowable leakage requirements of AWWA C600 and the requirements for water main equivalent type pipe as follows:
 - a. For sewers > 4", diameter, but < 16", diameter: PVC pipe > 4", diameter, but < 12", diameter shall meet AWWA C900 with elastomeric joints having a standard dimension ratio of 18 or less; PVC pipe > 12", diameter, but < 16", diameter shall meet AWWA C905 with elastomeric joints having a standard dimension ratio of 18 or less; Ductile iron pipe shall meet AWWA C115 or AWWA C151 having a thickness class 50 or more.
 - b. For sewers < 3", diameter, the pipe shall be any rigid pipe in the ch. Comm 84 "Table for Pipe and Tubing for Water Services and Private Water Mains," including approved ABS, brass, cast iron, CPVC, copper (not including type M copper) ductile iron, galvanized steel, polybutylene (PB), polyethylene (PE), PVC, or stainless steel pipe.
10. An influent sewer to a wastewater treatment plant;
11. The nearest existing or future grave site in cemeteries;
12. Wastewater treatment plant effluent pipe;
13. Buried pressurized sewer having pipe not conforming to ch. Comm 84; or
14. Manure loading area.

Note: The minimum separating distance between a well or reservoir and a lift station is based on the presence of a sewer force main at the lift station.

(d) One hundred feet between a well or reservoir and a:

1. Bulk surface storage tank with a capacity greater than 1,500 gallons or any bulk buried storage tank regardless of capacity, including, for both surface or buried tanks, associated buried piping for any solid, semi-solid or liquid product but not including those regulated under par. (b) 12. This subdivision includes, but is not limited to petroleum product tanks, waste oil tanks and pesticide or fertilizer storage tanks not regulated under par. (a) 11. This subdivision does not include septic, holding and manure reception tanks, or liquified petroleum gas tanks as specified in ch. Comm 11.
2. Liquid-tight, fabricated manure or silage storage structure, in ground or at ground surface;
3. Wastewater treatment plant structure, conveyance or treatment unit; or
4. Dry fertilizer or pesticide storage building or area when more than 100 pounds of either or both materials are stored;
5. Well, drillhole or water system used for the underground placement of any waste, surface or subsurface water or any substance as defined in s. 160.01 (8), Stats.;
6. Stormwater infiltration basin;
7. Uncovered storage of silage on the ground surface;
8. Water-tight silage storage trench or pit; or
9. Lift station.

(e) Two hundred feet between a school well and a soil absorption unit receiving less than 8,000 gallons per day, existing or abandoned.

(ee) One hundred fifty feet between a well or reservoir and a temporary manure stack.

(f) Two hundred fifty feet between a well or reservoir and a:

1. Manure stack.
2. Earthen or excavated manure storage structure.

Note: Variances from the separating distances may be granted as specified in s. NR 812.43 for earthen storage and manure stacks constructed and maintained to the specifications of Soil Conservation Standards No. 425 or 312, respectively.

3. Soil absorption unit receiving 8,000 or more gallons per day, existing, abandoned, or alternate.

4. Sludge landspreading or drying area.
5. An earthen silage storage trench or pit.
6. Liquid waste disposal system including, but not limited to a treatment pond or lagoon, ridge and furrow system and spray irrigation system.

Note: Variance from this separating distance may be granted for treatment ponds or lagoons constructed and maintained to an approval granted under ch. NR 213.

7. Salvage yard.
8. A salt or deicing material storage area including the building structure and the surrounding area where the material is transferred to vehicles. This subdivision does not include bagged deicing material.
9. Solid waste processing facility.
10. Solid waste transfer facility.
11. The boundaries of a landspreading facility for spreading of petroleum-contaminated soil regulated under ch. NR 718 while that facility is in operation.

(g) Twelve hundred feet between a well or reservoir and:

1. The nearest edge of the limits of filling of an existing, proposed or abandoned landfill, measured to the nearest fill area of abandoned landfills, if known. Otherwise measured to the nearest property line where the landfill is located. The department may require, as part of a variance request, a land survey map, a scaled diagram of the landfill and the well location, or another accurate measurement method to determine and demonstrate the distance between the landfill and the well;
2. The nearest edge of a coal storage area in excess of 500 tons; or
3. A hazardous waste treatment facility regulated by the department

A-82.30 (11) (f) CONNECTION TO PRESSURIZED PUBLIC SEWER.

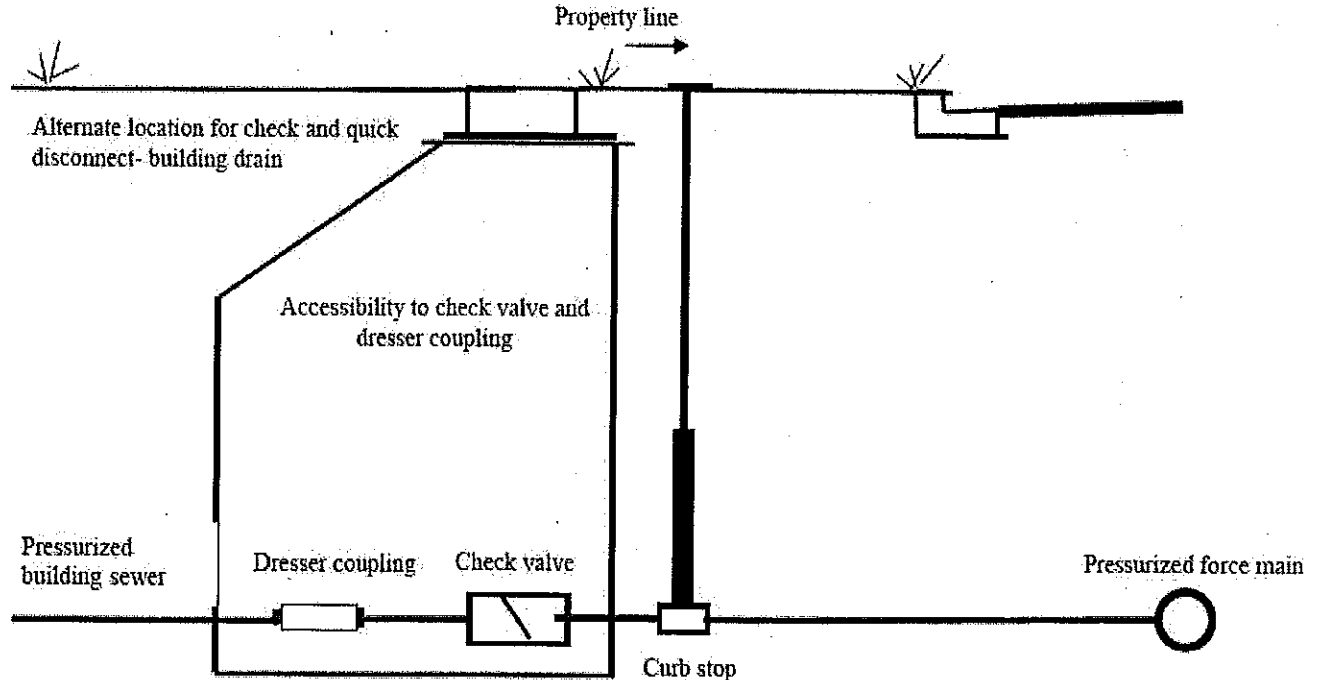

A-82.31 (4)-1. WHERE A VENT STACK AND STACK VENT ARE REQUIRED.

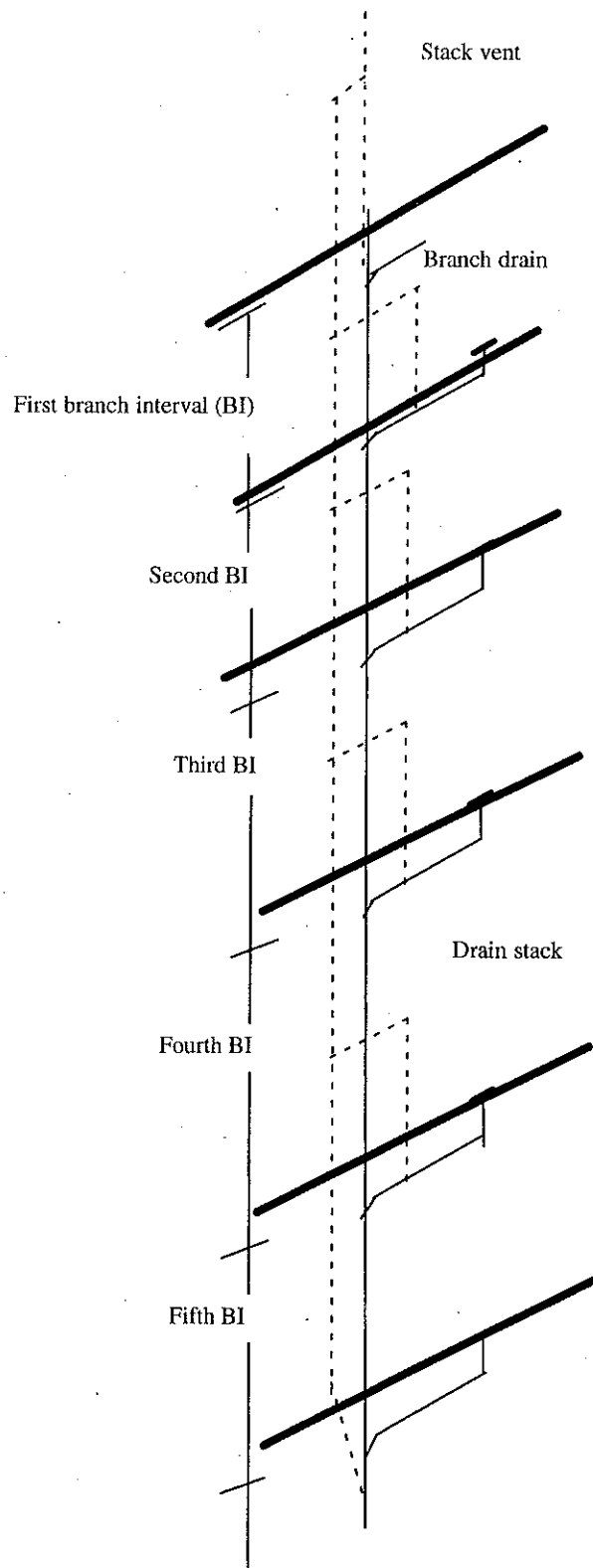

4. Sludge landspreading or drying area.
5. An earthen silage storage trench or pit.
6. Liquid waste disposal system including, but not limited to a treatment pond or lagoon, ridge and furrow system and spray irrigation system.

Note: Variance from this separating distance may be granted for treatment ponds or lagoons constructed and maintained to an approval granted under ch. NR 213.

7. Salvage yard.
 8. A salt or deicing material storage area including the building structure and the surrounding area where the material is transferred to vehicles. This subdivision does not include bagged deicing material.
 9. Solid waste processing facility.
 10. Solid waste transfer facility.
 11. The boundaries of a landspreading facility for spreading of petroleum-contaminated soil regulated under ch. NR 718 while that facility is in operation.
- (g) Twelve hundred feet between a well or reservoir and:
1. The nearest edge of the limits of filling of an existing, proposed or abandoned landfill, measured to the nearest fill area of abandoned landfills, if known. Otherwise measured to the nearest property line where the landfill is located. The department may require, as part of a variance request, a land survey map, a scaled diagram of the landfill and the well location, or another accurate measurement method to determine and demonstrate the distance between the landfill and the well;
 2. The nearest edge of a coal storage area in excess of 500 tons; or
 3. A hazardous waste treatment facility regulated by the department

A-82.30 (11) (f) CONNECTION TO PRESSURIZED PUBLIC SEWER.

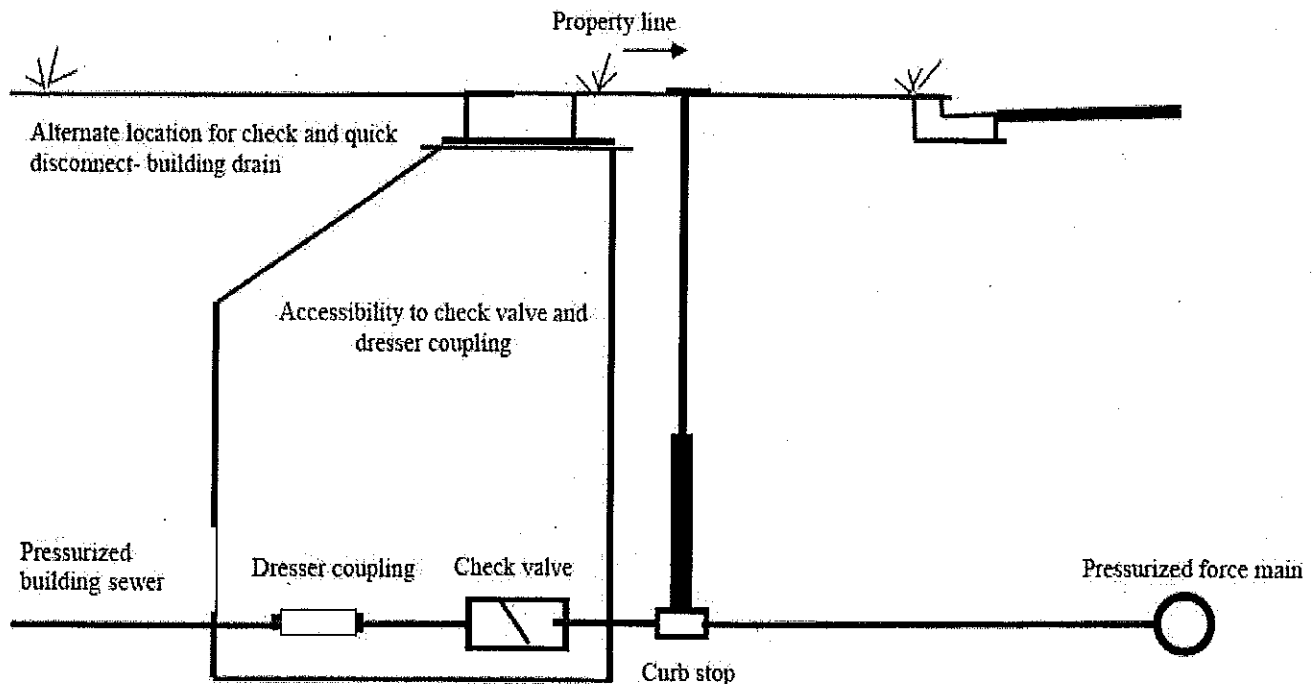

A-82.31 (4)-1. WHERE A VENT STACK AND STACK VENT ARE REQUIRED.

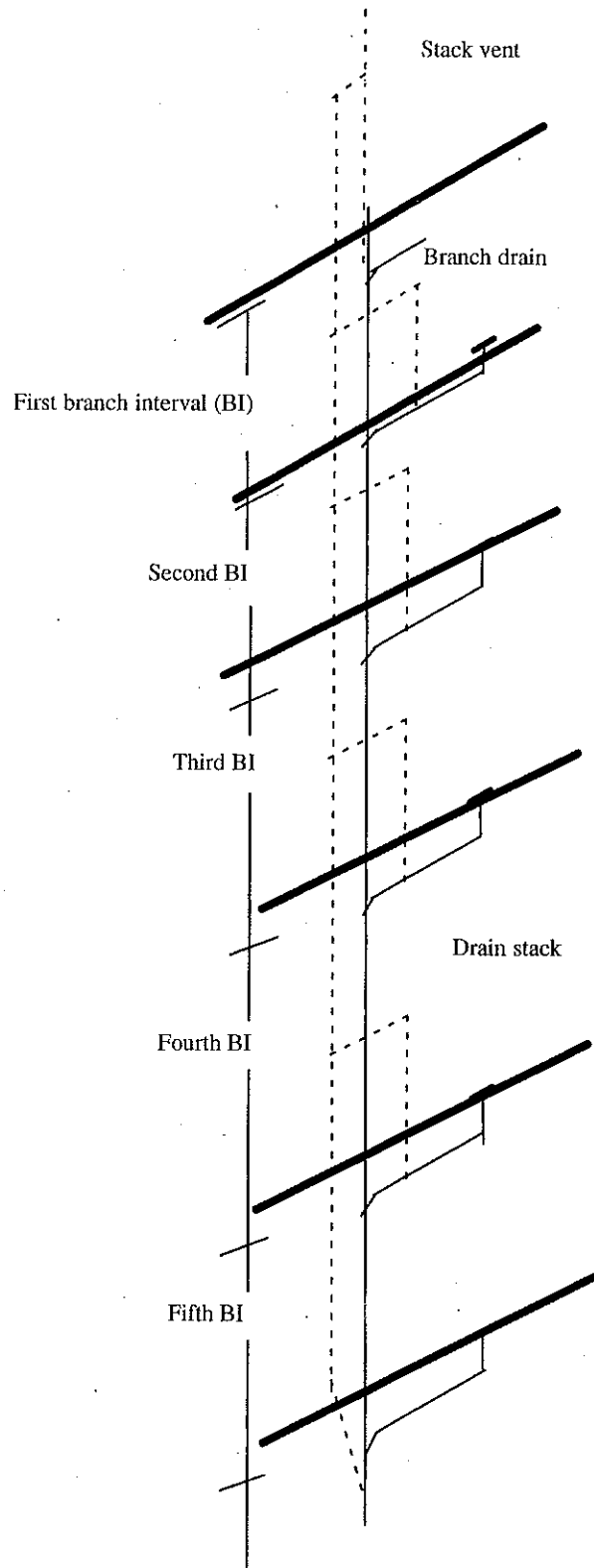

A-82.31(4)-2. INSTALLATION OF VENT STACK AND STACK VENT.

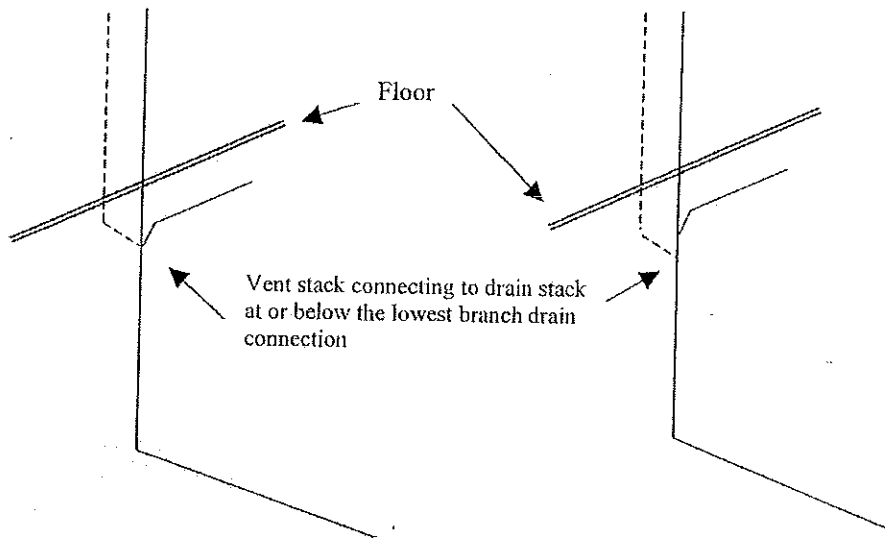

A-82.31(5)(a) VENTING OFFSETS OF 30 TO 45 DEGREES.

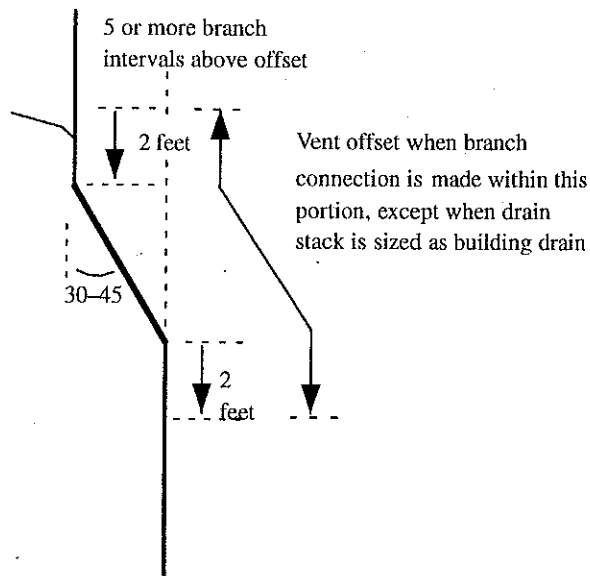

A-82.31 (5) (b) VENTS FOR OFFSETS OF MORE THAN 45 DEGREES.

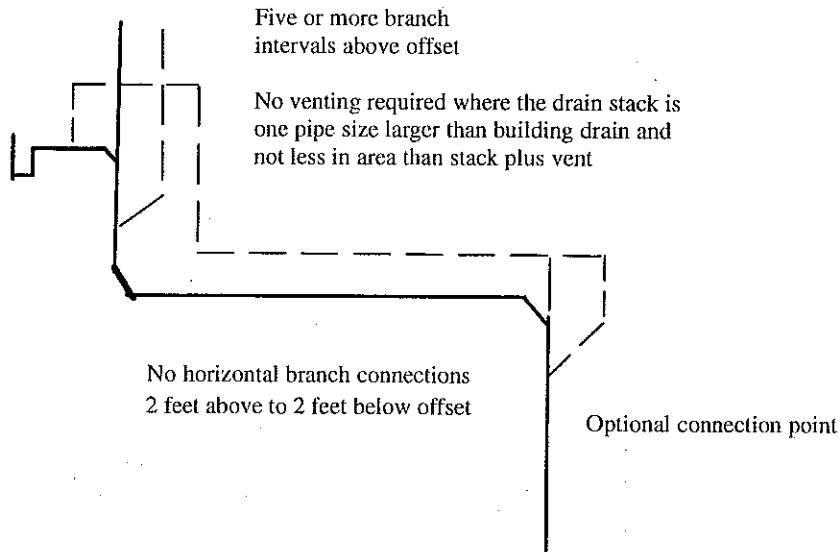

A-82.31 (7) RELIEF VENTS FOR BUILDING DRAINS.

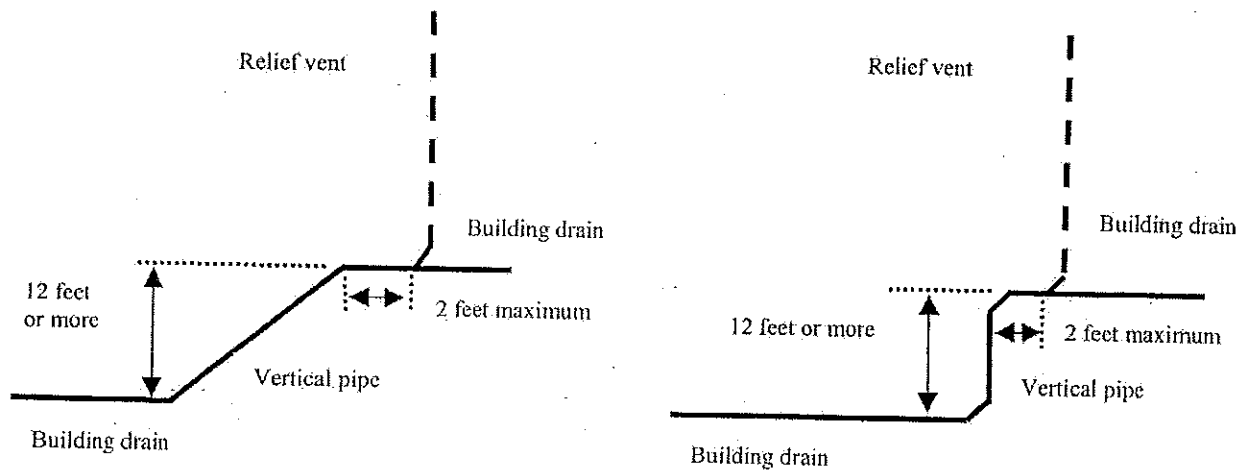

A-82.31 (9) FLXTURE VENTS.

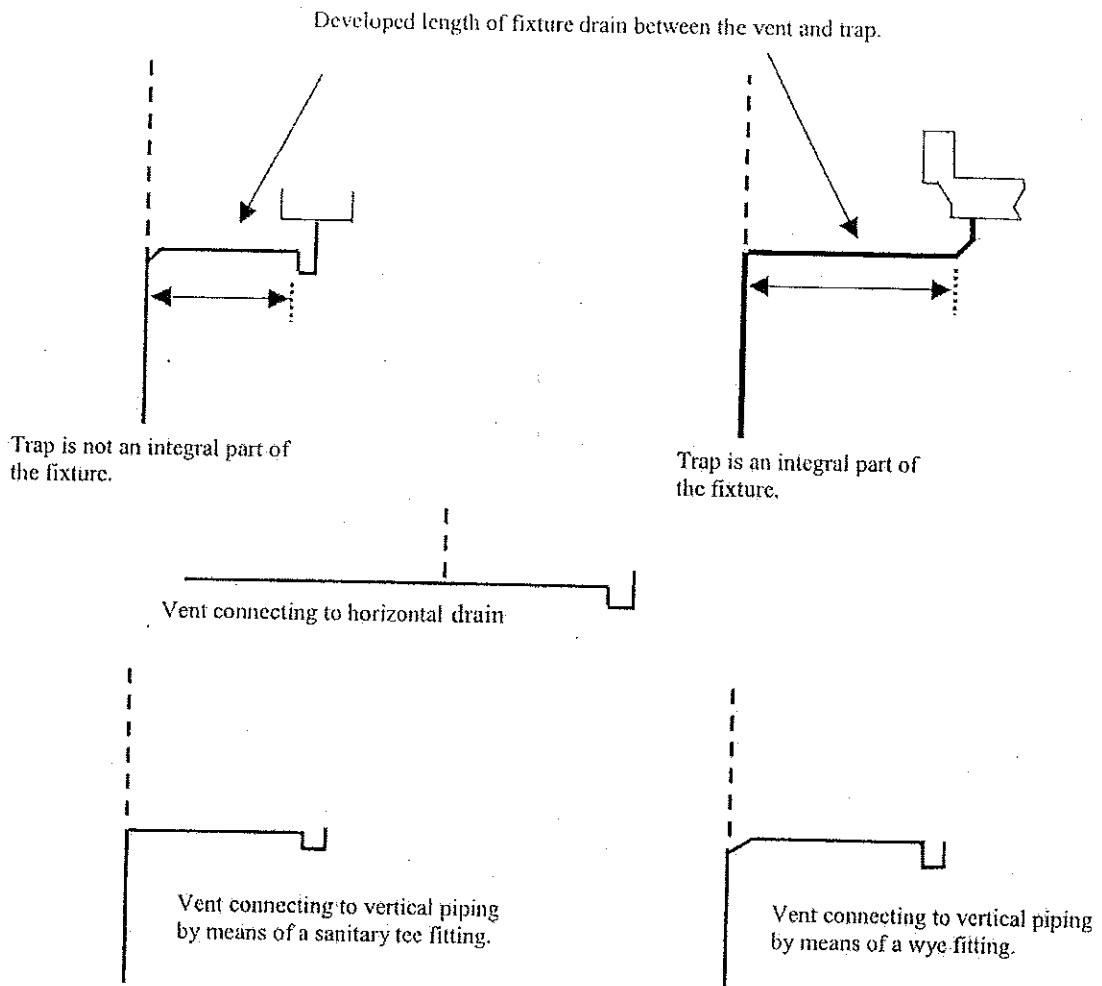

A-82.31 (10)-1. CIRCUIT VENTING.

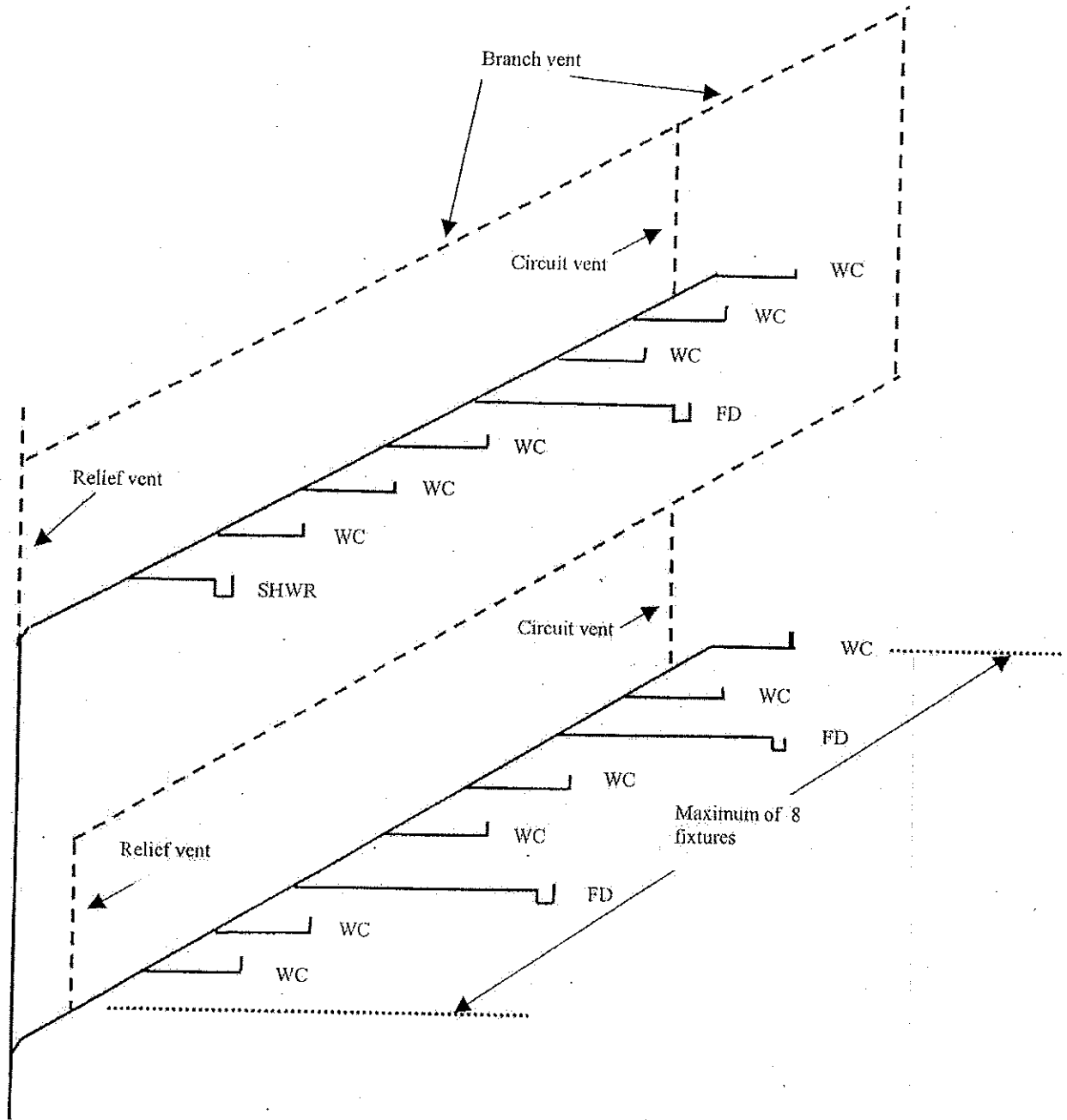

A-82.31 (10)-2. CIRCUIT VENTING.

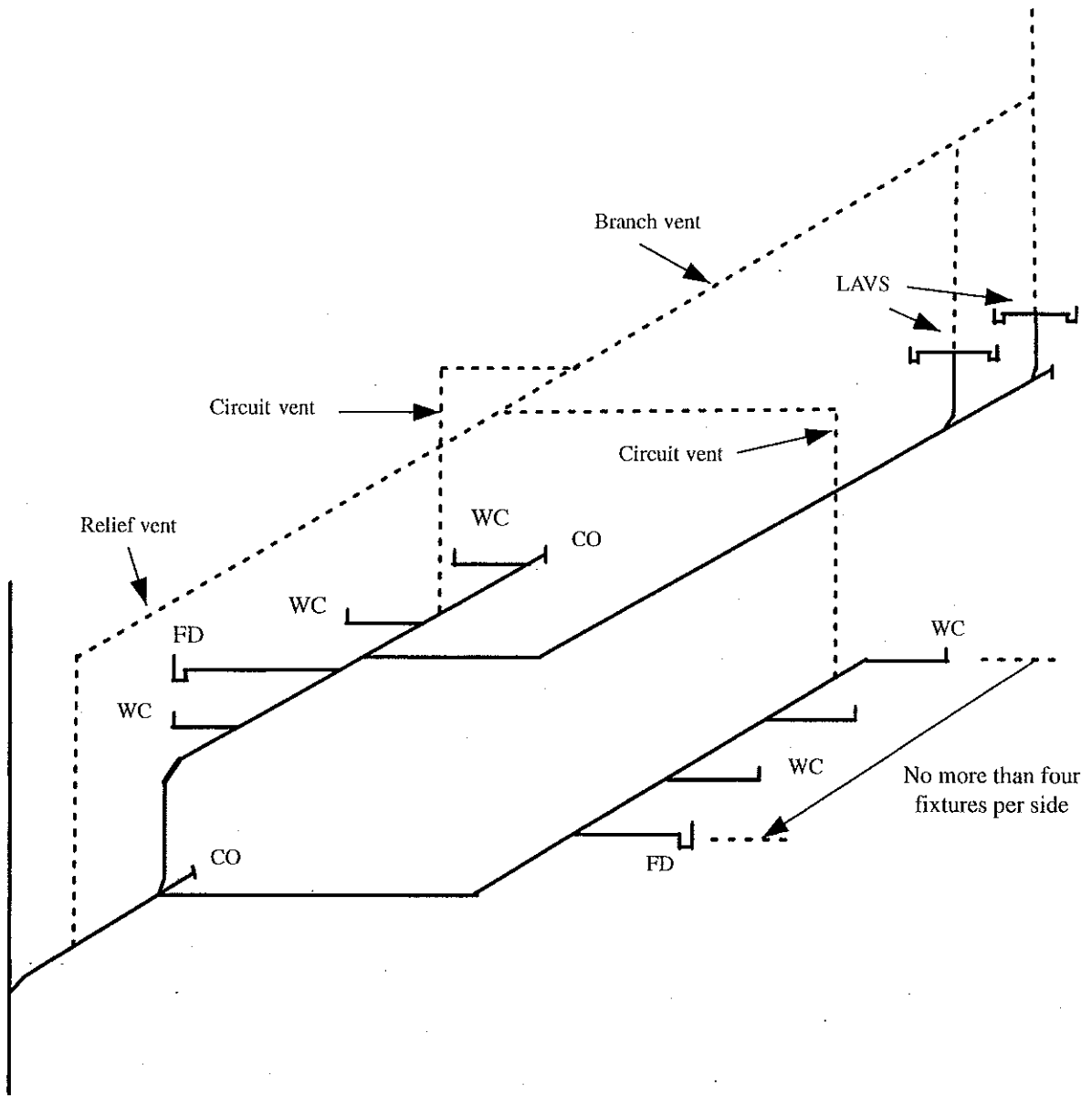

A-82.31(10)-3. CIRCUIT VENTING.

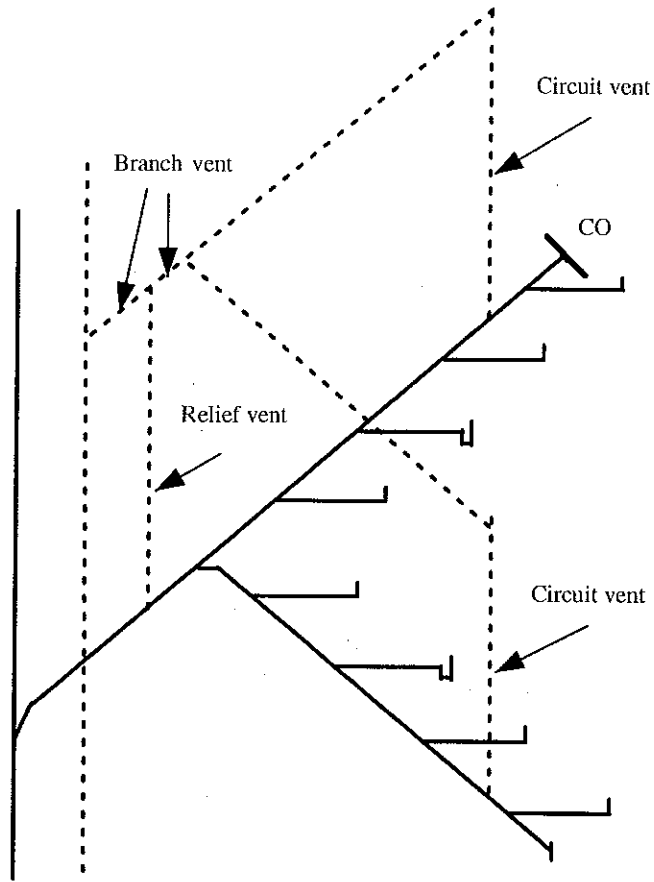

A-82.31 (10)-4. CIRCUIT VENTING.

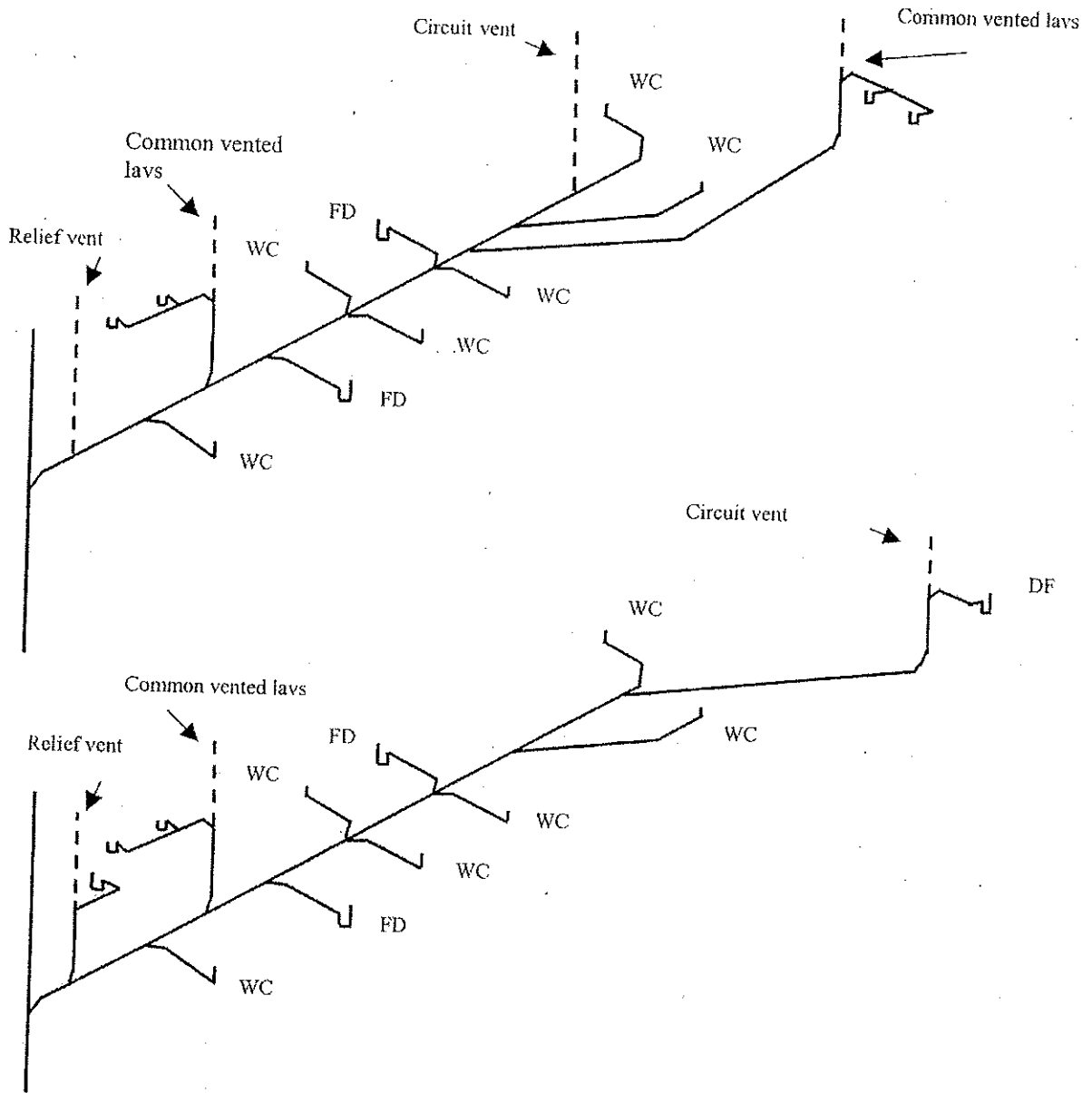

A-82.31 (11) (a) COMMON VENTS, VERTICAL, SERVING ANY TWO FIXTURES.

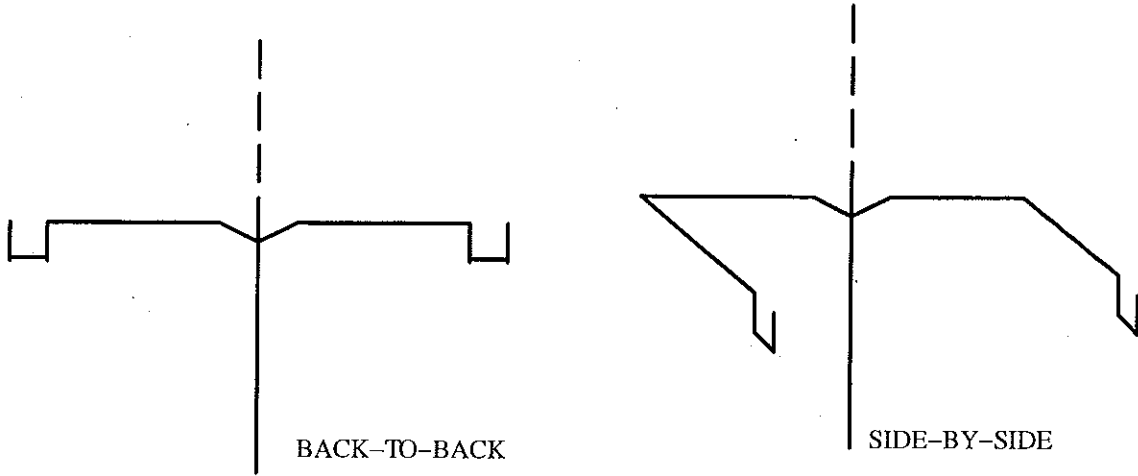

A-82.31 (11) (b) COMMON VENTS, HORIZONTAL DRAINS.

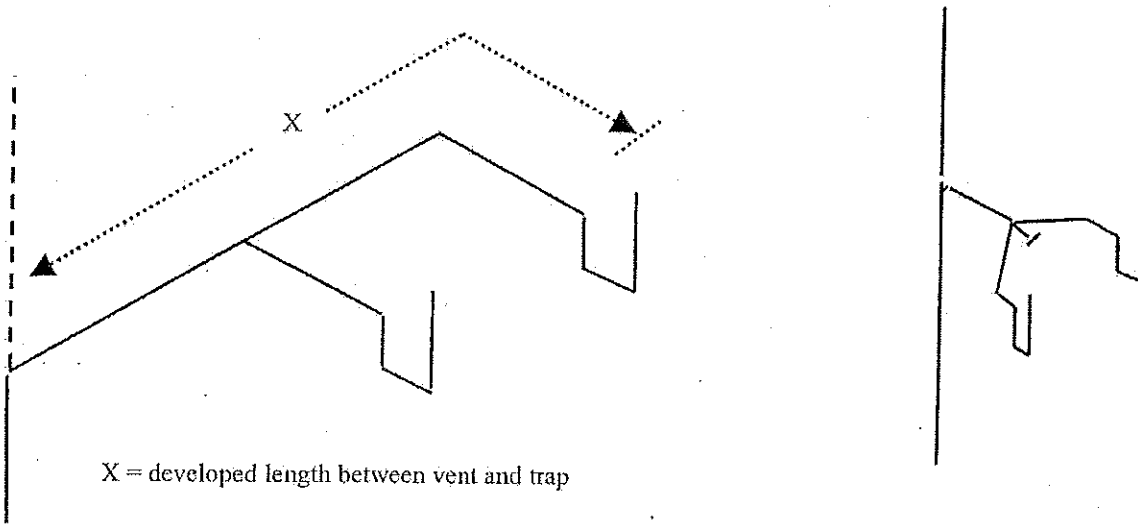

A-82.31 (12) RETURN VENTS.

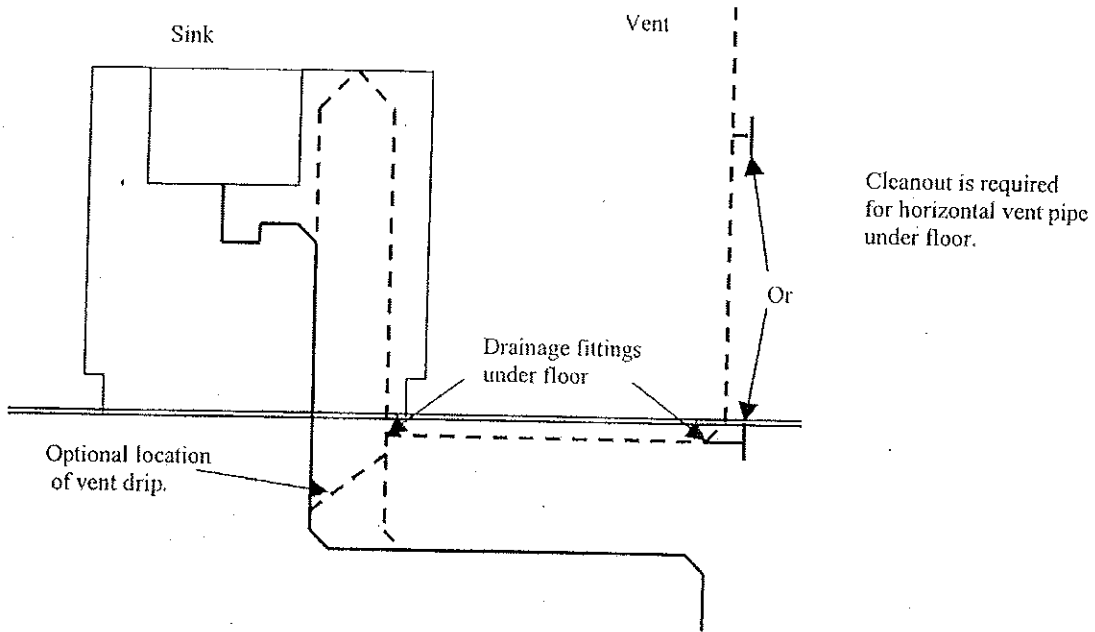

A-82.31 (13) (a) VERTICAL WET VENTS.

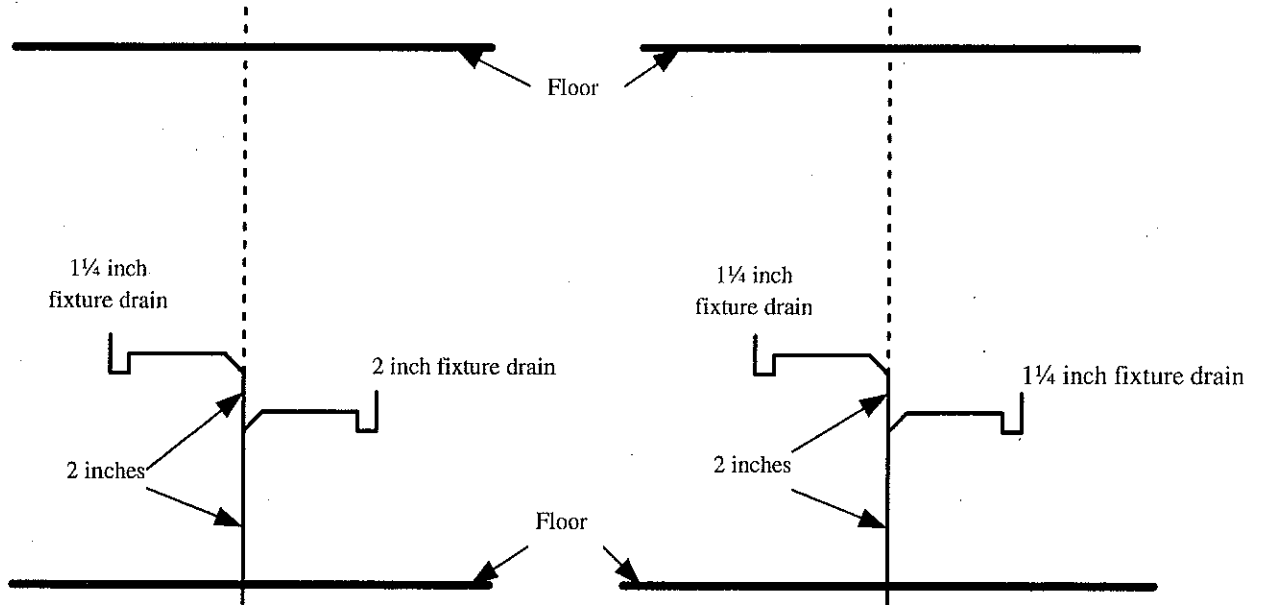

A-82.31 (13)-1. HORIZONTAL WET VENTS.

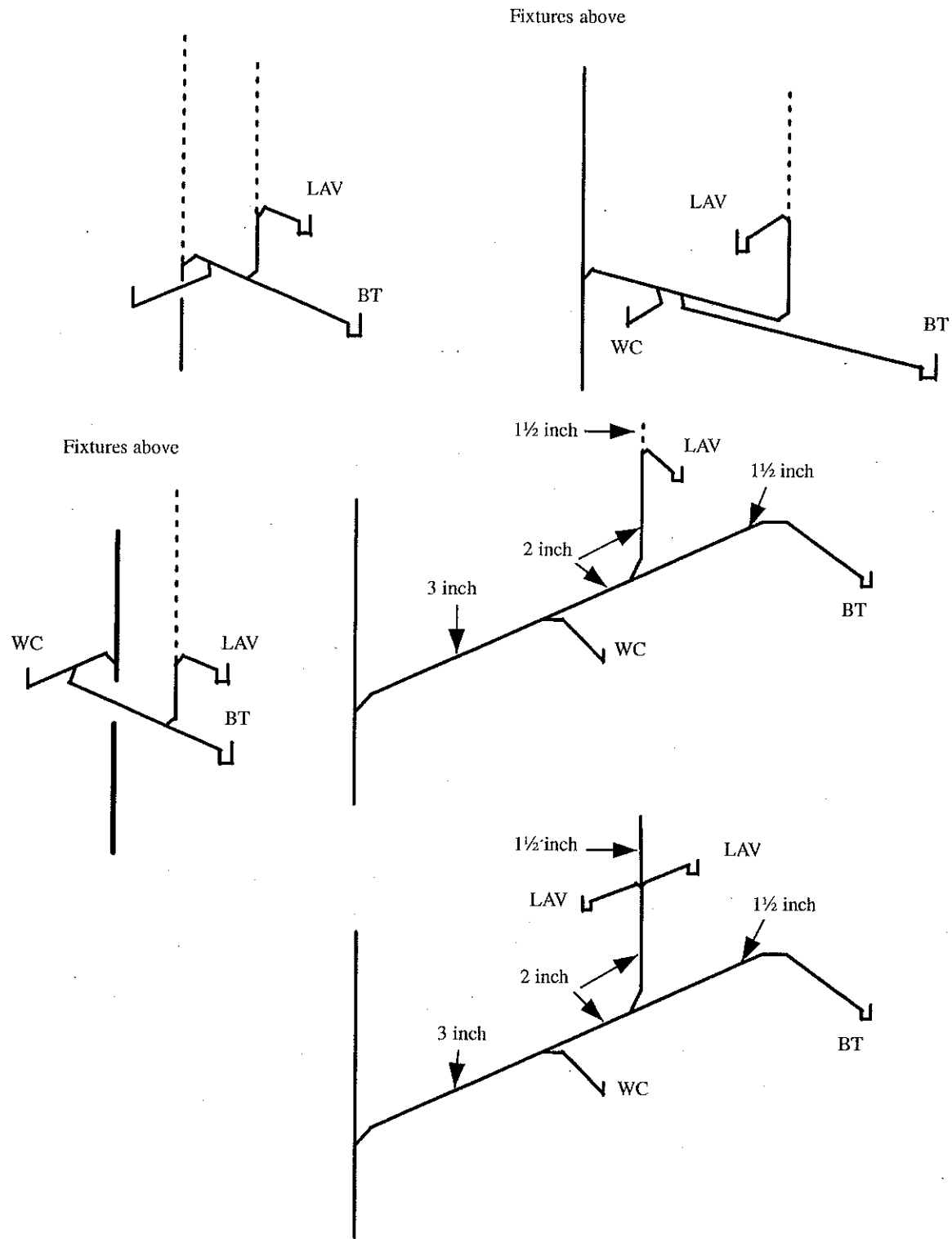

A-82.31(13)-2. WET VENTING – FLOOR OUTLET FIXTURES.

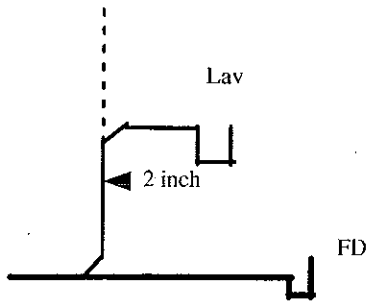

Individual vent serving as a wet vent

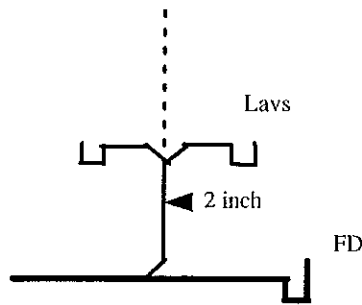

Common vents serving as a wet vent

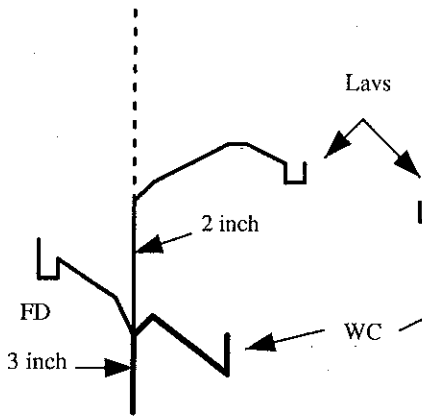
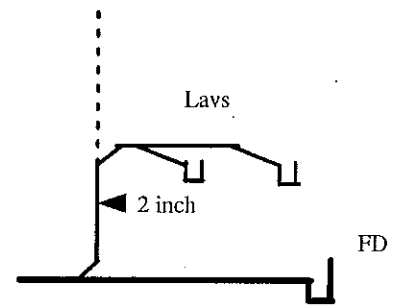

Individual vent serving as a wet vent

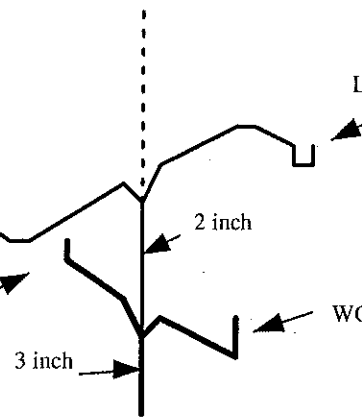

Common vents serving as a wet vent

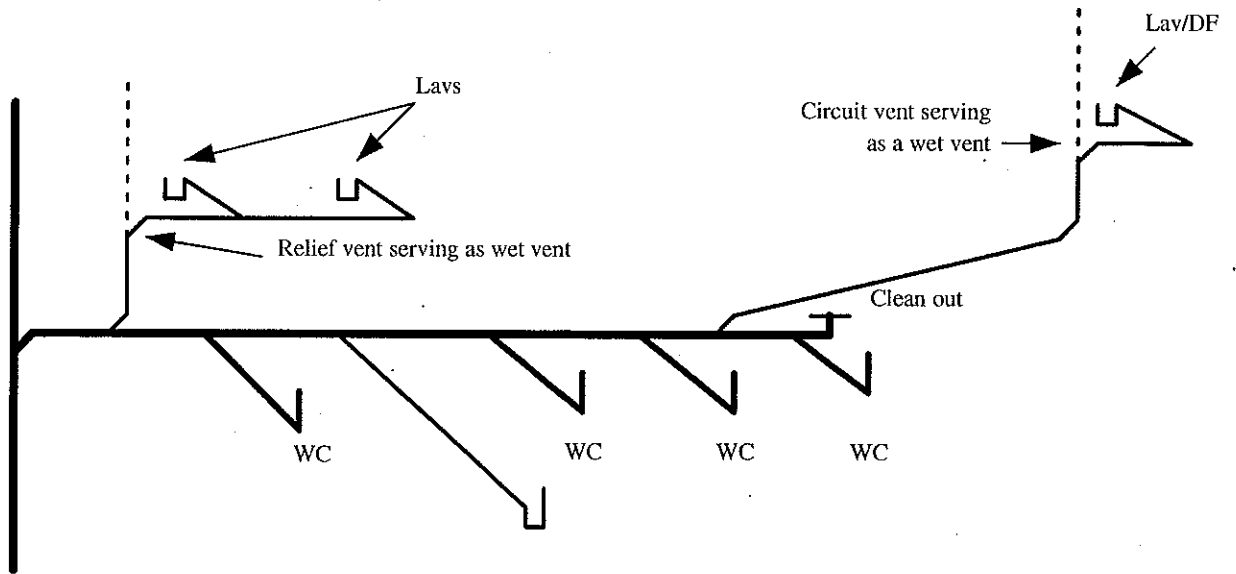
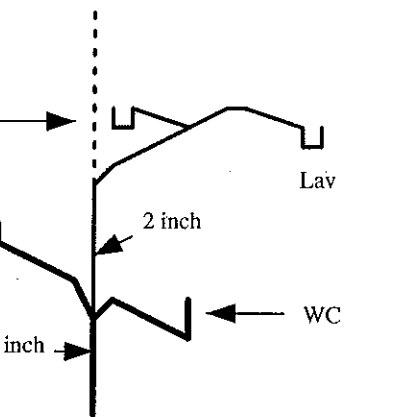

A-82.31 (14) (a) and (b) SIZING VENT STACKS AND STACK VENTS

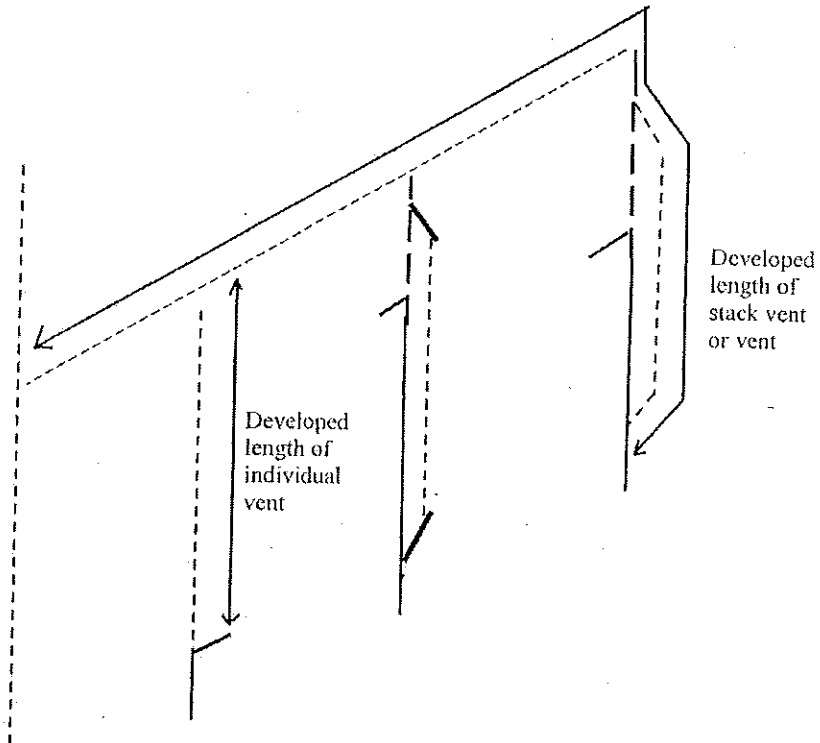

A-82.31 (14) (c) SIZING BRANCH VENTS SERVING A WET VENT.

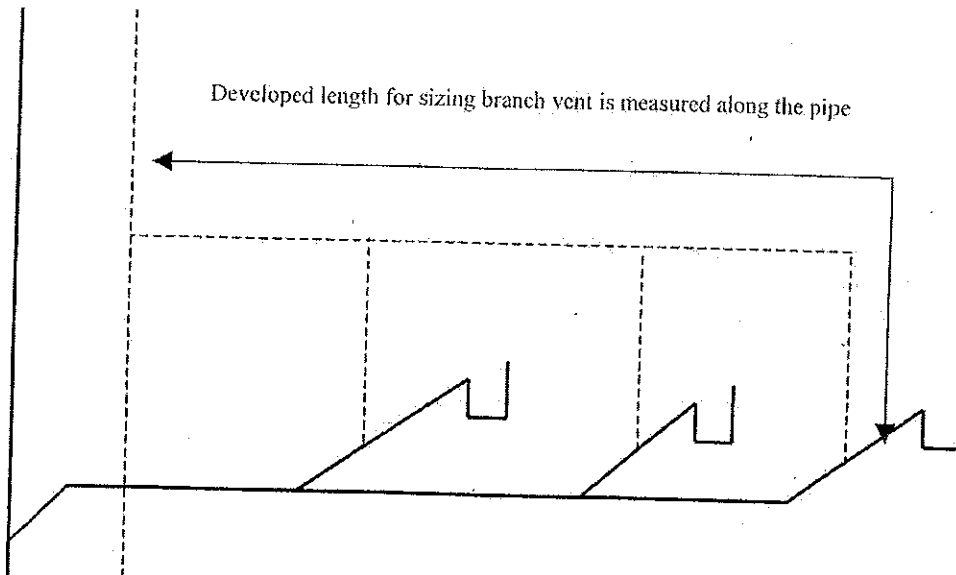

A-82.31 (14) (d) SIZING INDIVIDUAL VENTS.

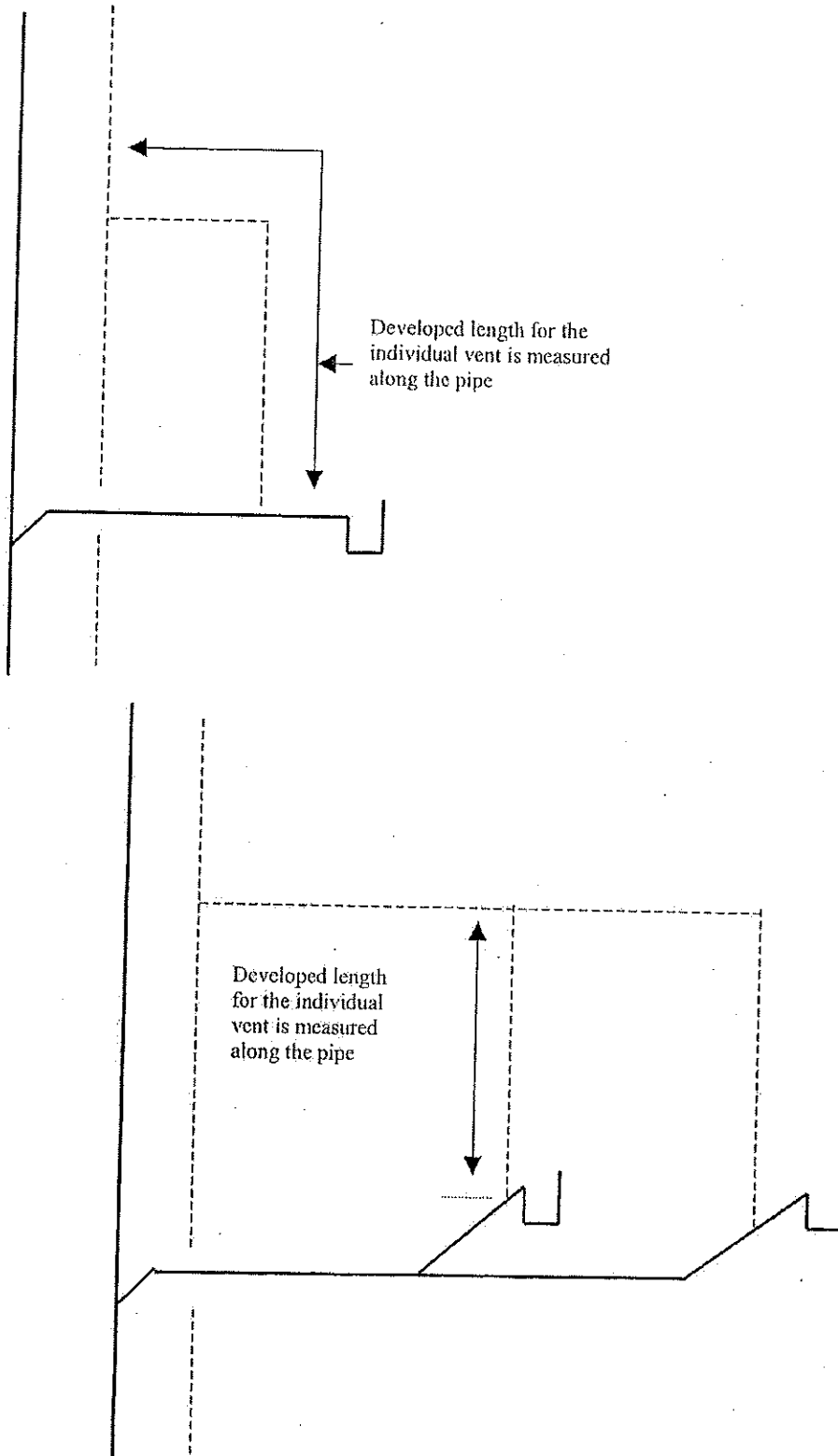

A-82.31 (15) (a) VENT GRADES AND CONNECTIONS.

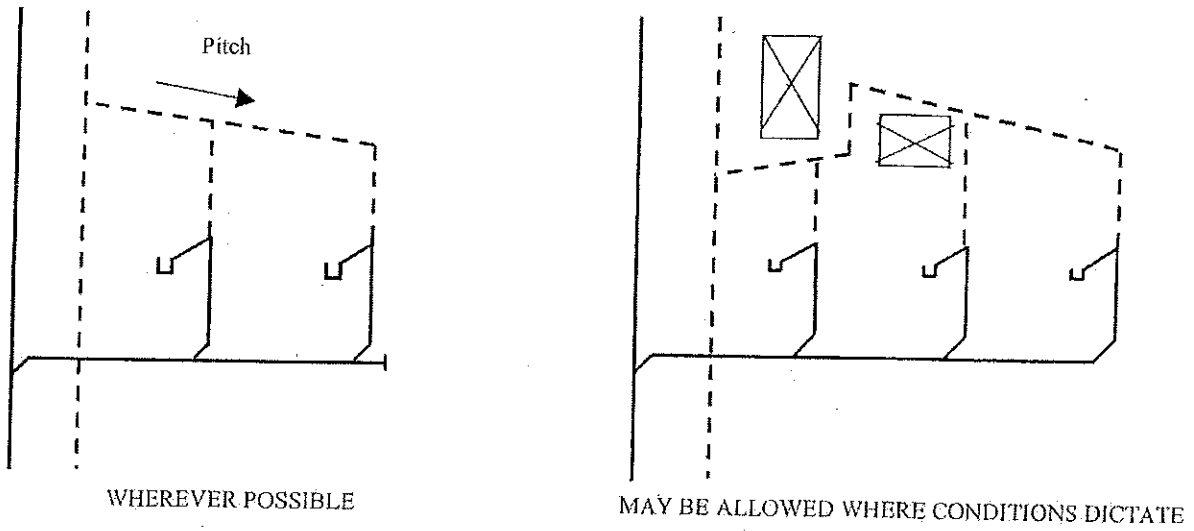

A-82.31 (15) (b) VENT GRADES AND CONNECTIONS.

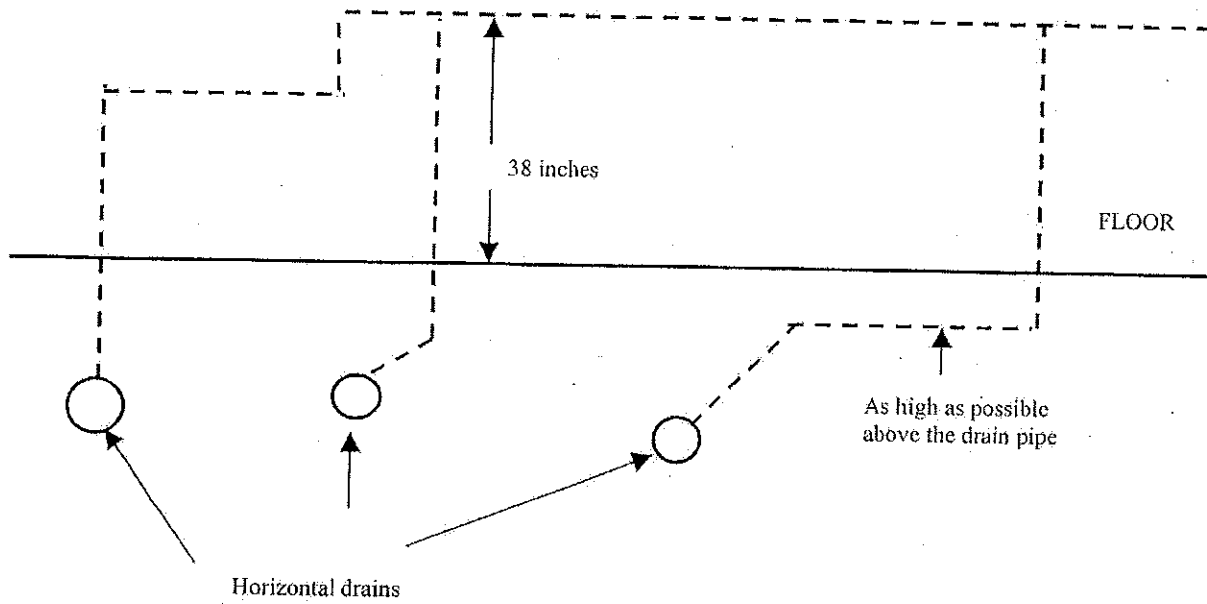

A-82.31 (16) VENT TERMINALS.

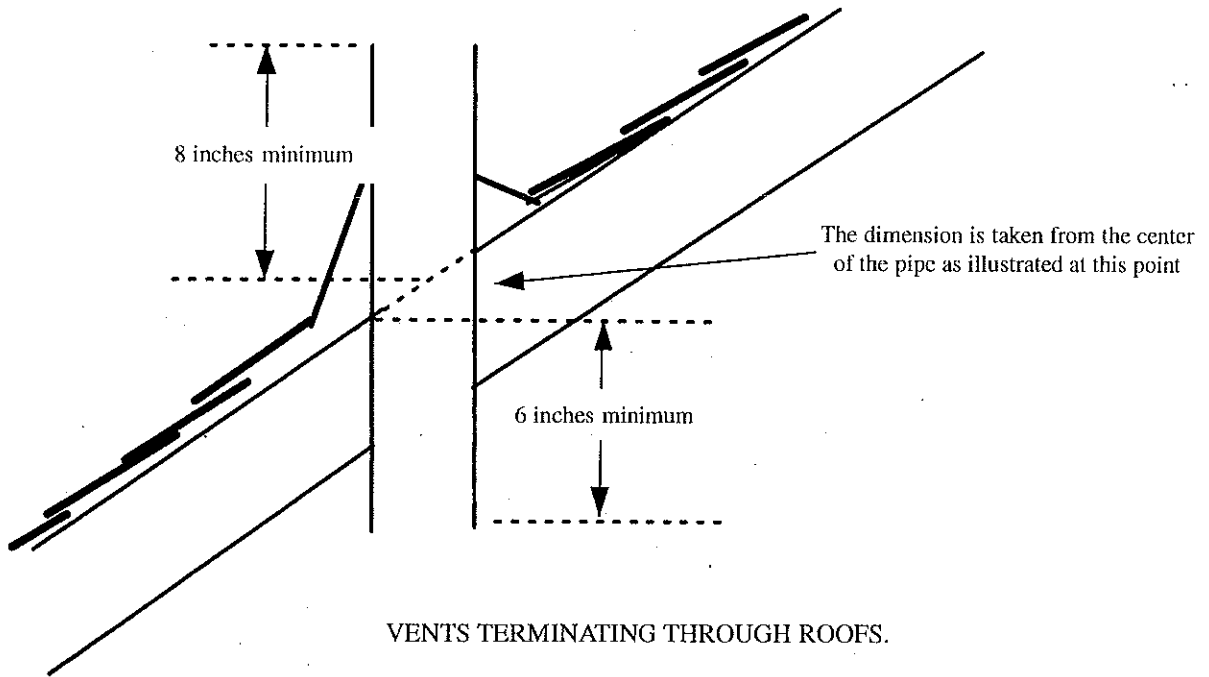

A-82.31 (16) VENT TERMINALS.

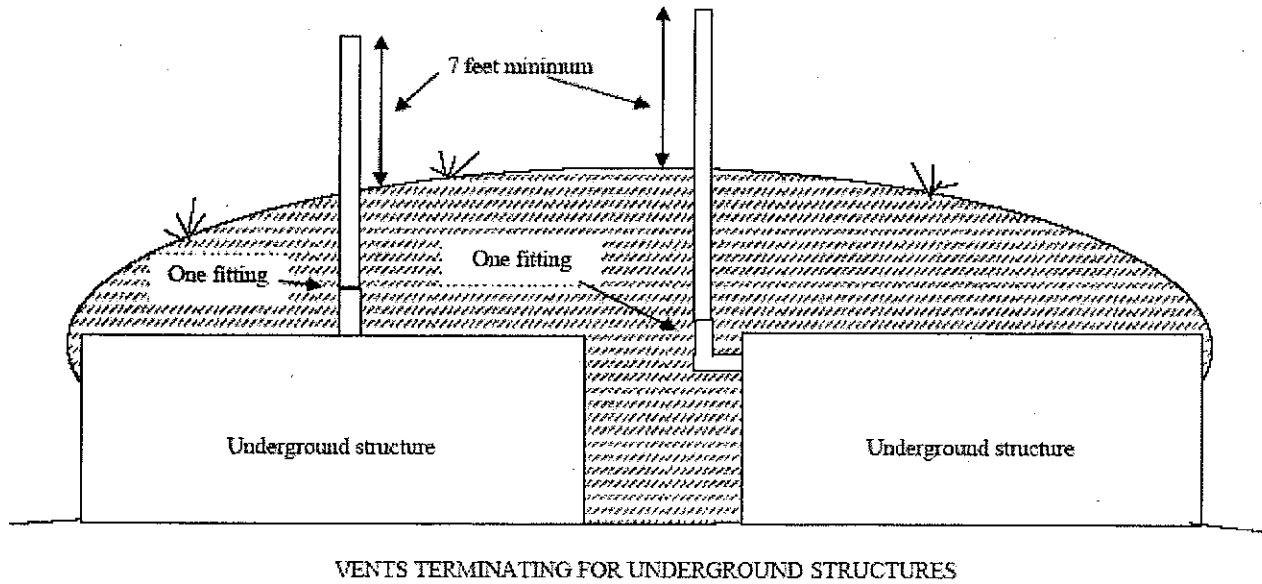
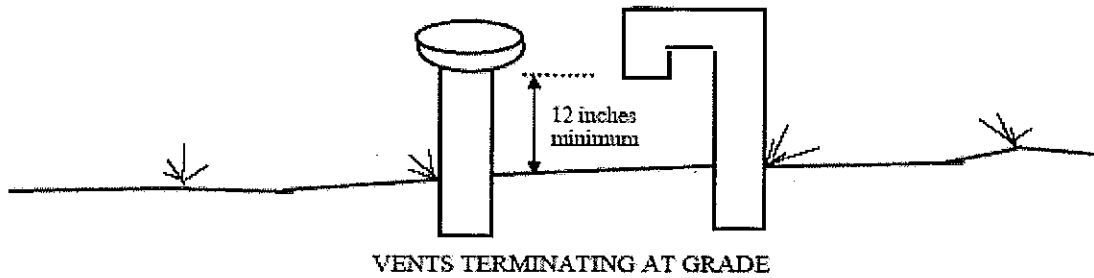

A-82.31 (17) (a) COMBINATION DRAIN AND VENT STACKS.

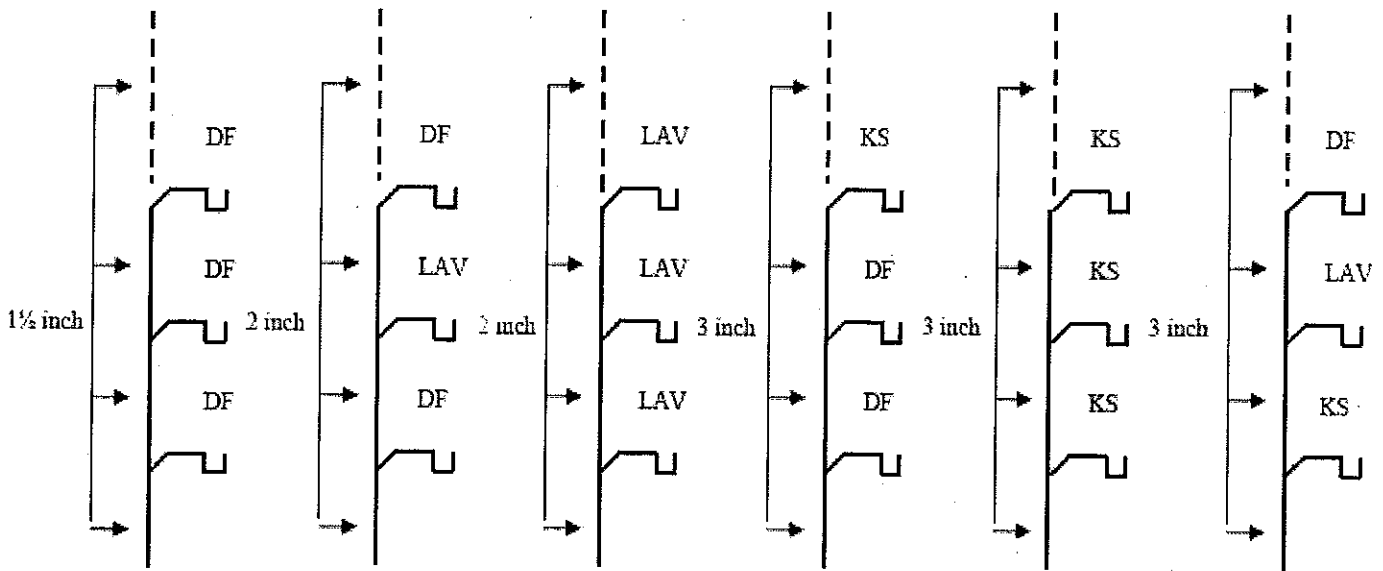

Most restrictive fixture determines stack size

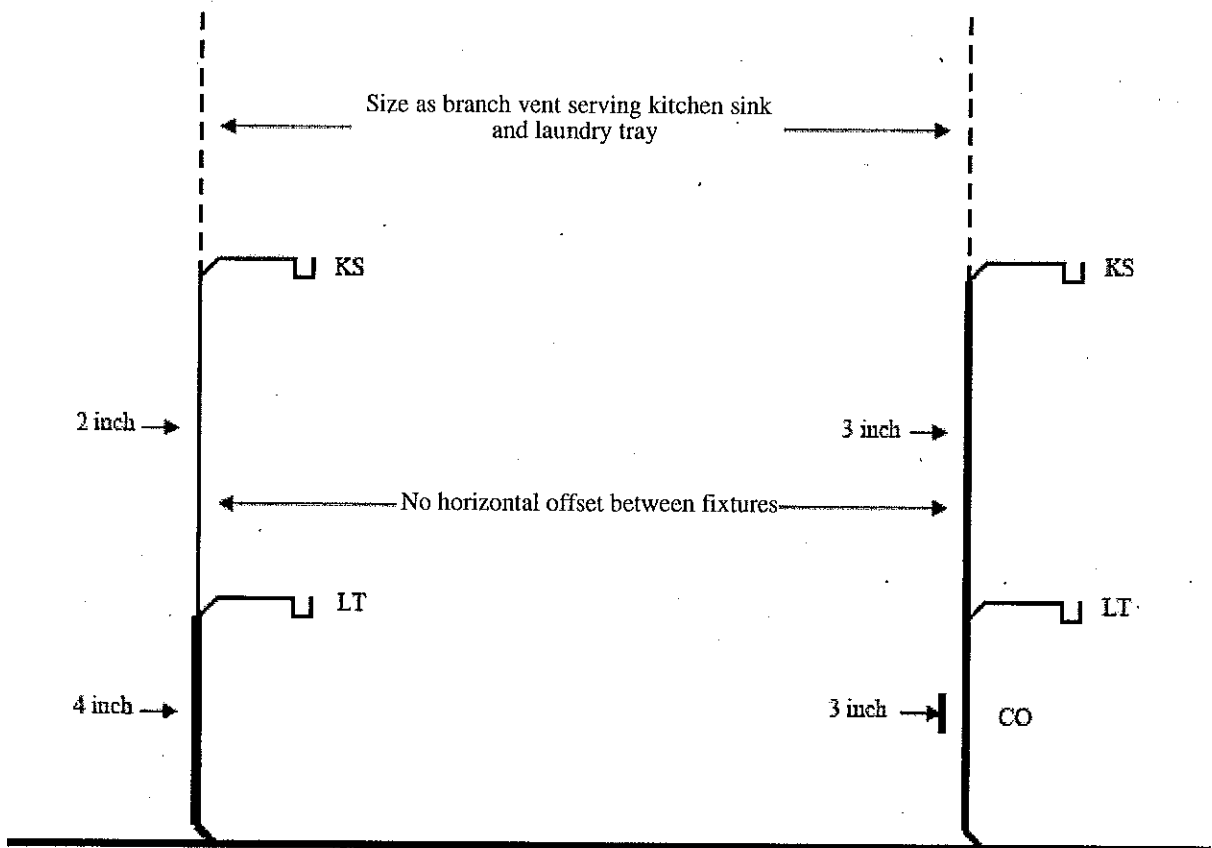

A-82.31 (17) (b) COMBINATION DRAIN AND VENT BUILDING DRAIN.

Stacks must be $\frac{1}{2}$ size of building drain, but not less than 2 inches in diameter

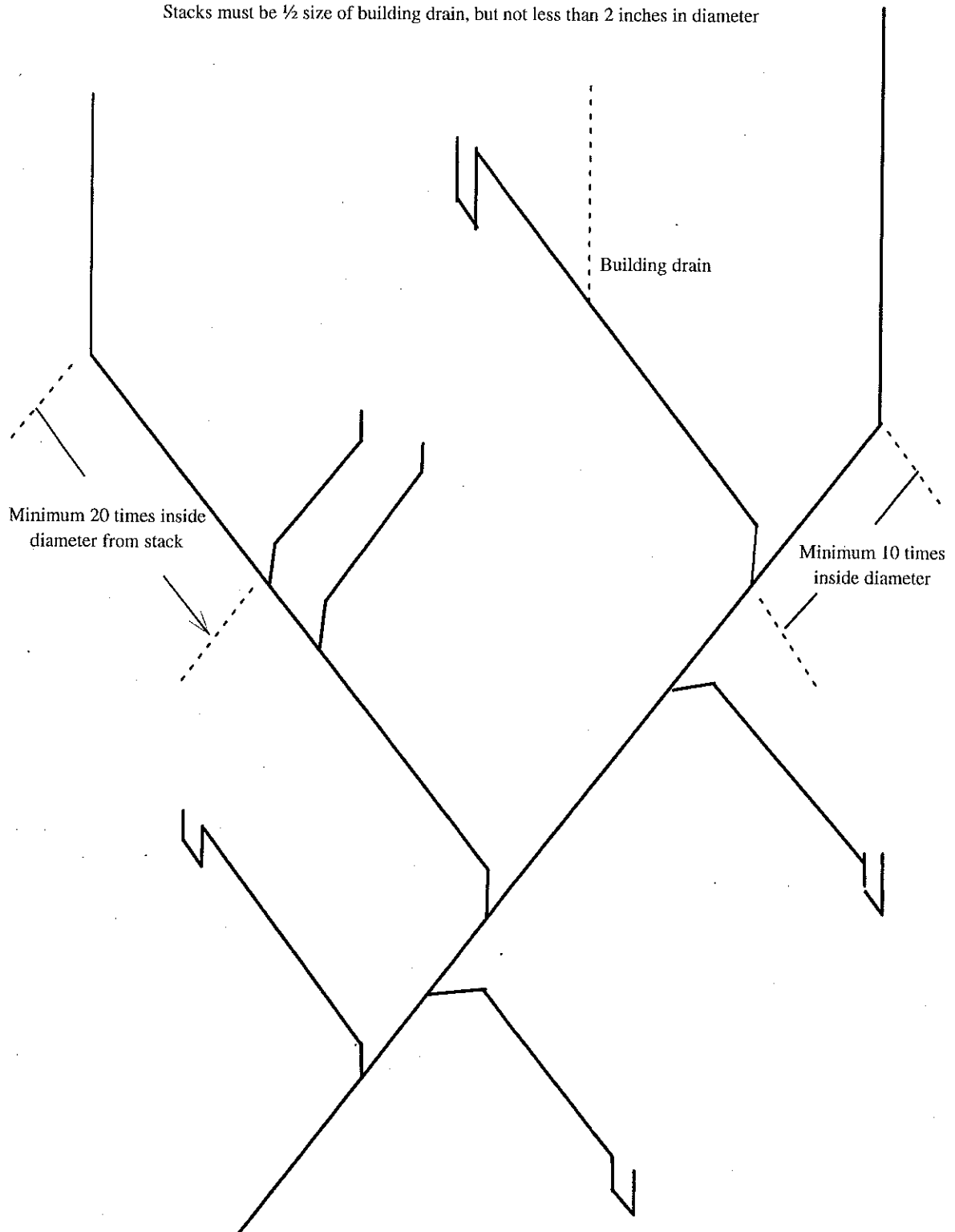

A-82.31 (17) (c) COMBINATION DRAIN AND VENT LABORATORY SINK VENTING.

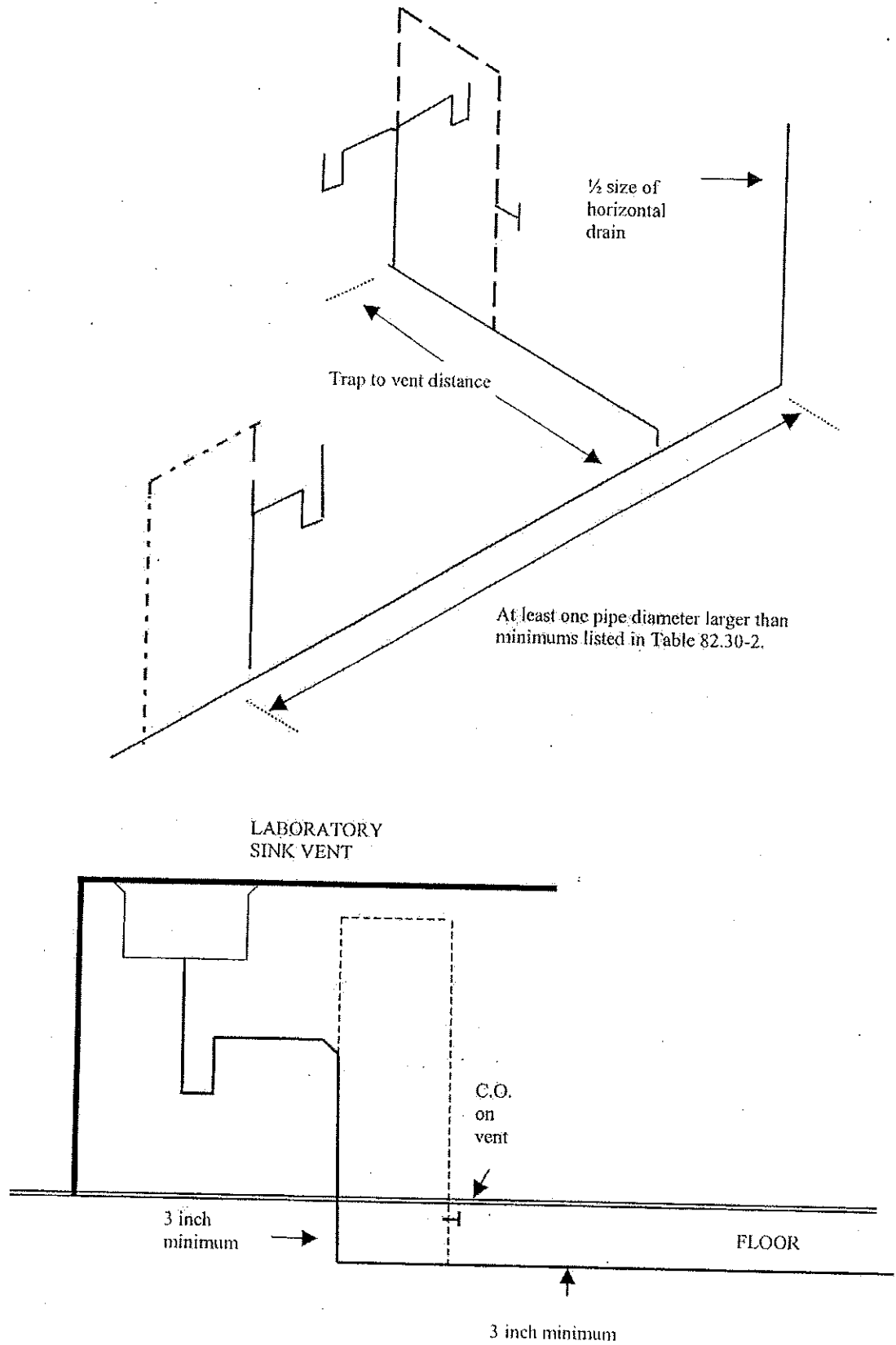

A-82.32 (4) (b) INSTALLATION OF TRAPS.

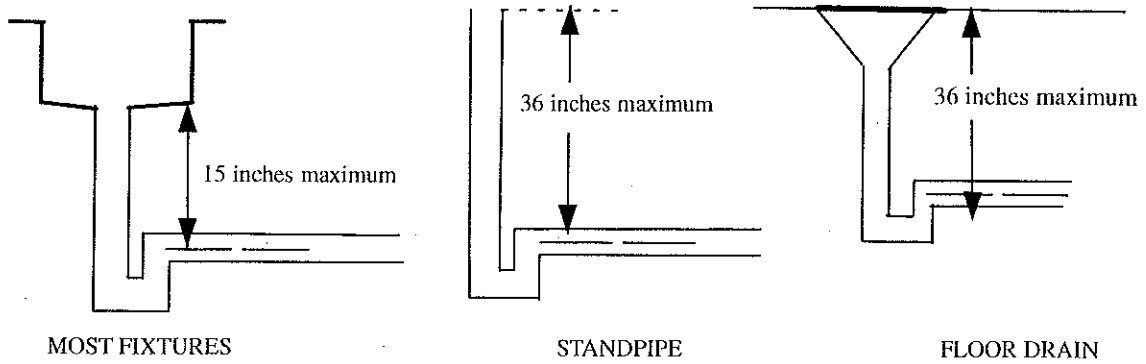

MOST FIXTURES

STANDPIPE

FLOOR DRAIN

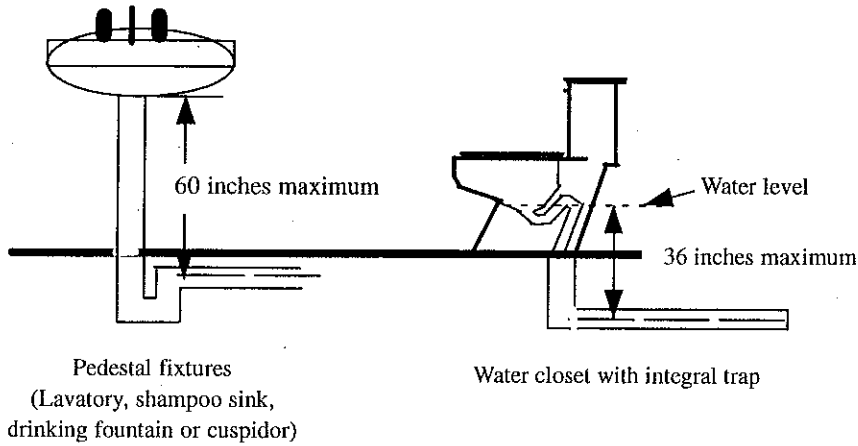

Pedestal fixtures
(Lavatory, shampoo sink,
drinking fountain or cuspidor)

Water closet with integral trap

VERTICAL DISTANCE BETWEEN FIXTURE DRAIN OUTLET AND TRAP

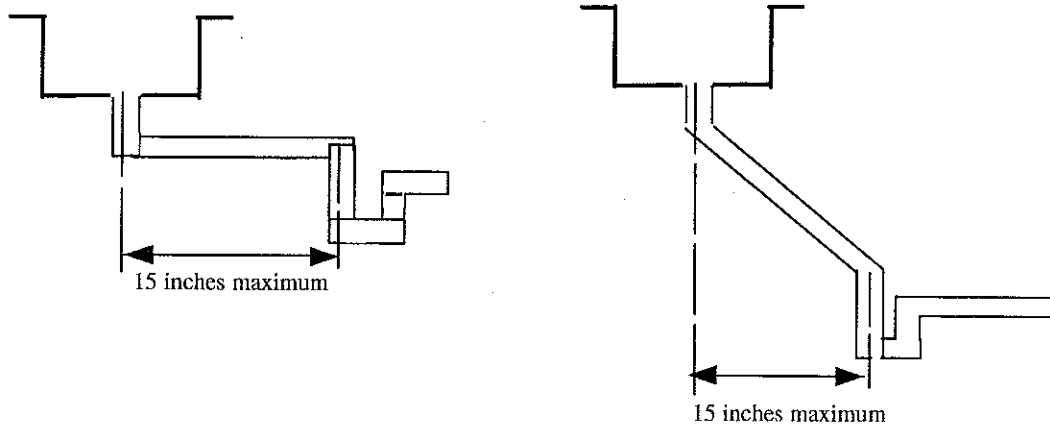

HORIZONTAL DISTANCE BETWEEN FIXTURE DRAIN OUTLET AND TRAP

A-82.33 (6)-1. INDIRECT WASTE PIPING.

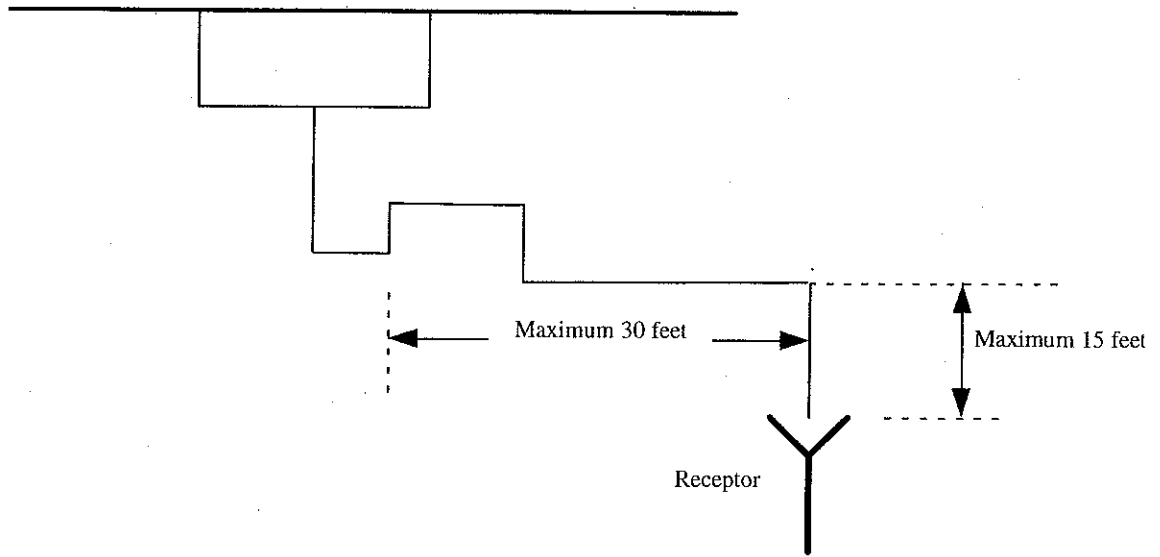

A-82.33 (6)-2. LOCAL WASTE PIPING.

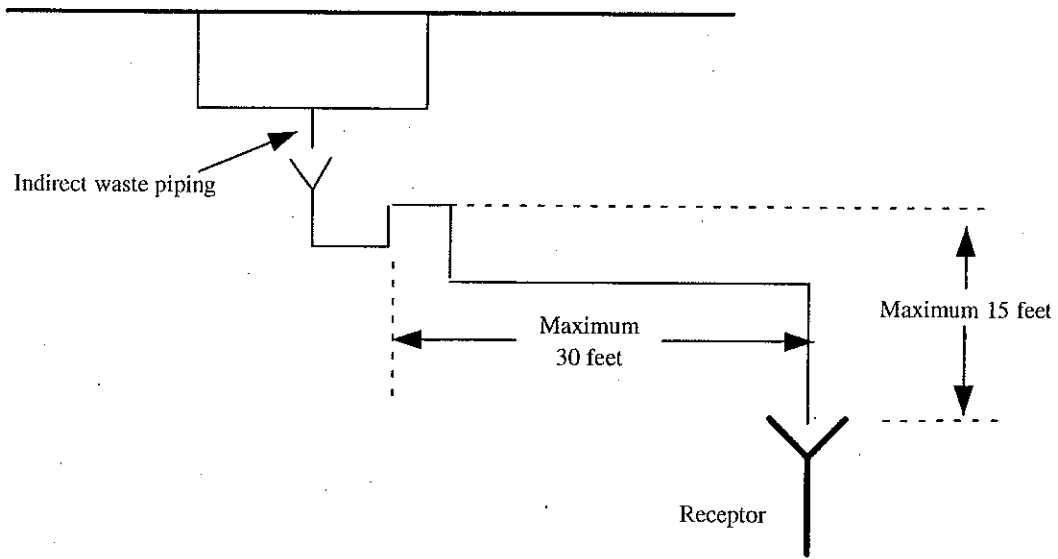

MAXIMUM LENGTH OF LOCAL WASTE PIPE

A-82.33 (7) AIR-GAPS AND AIR-BREAKS.

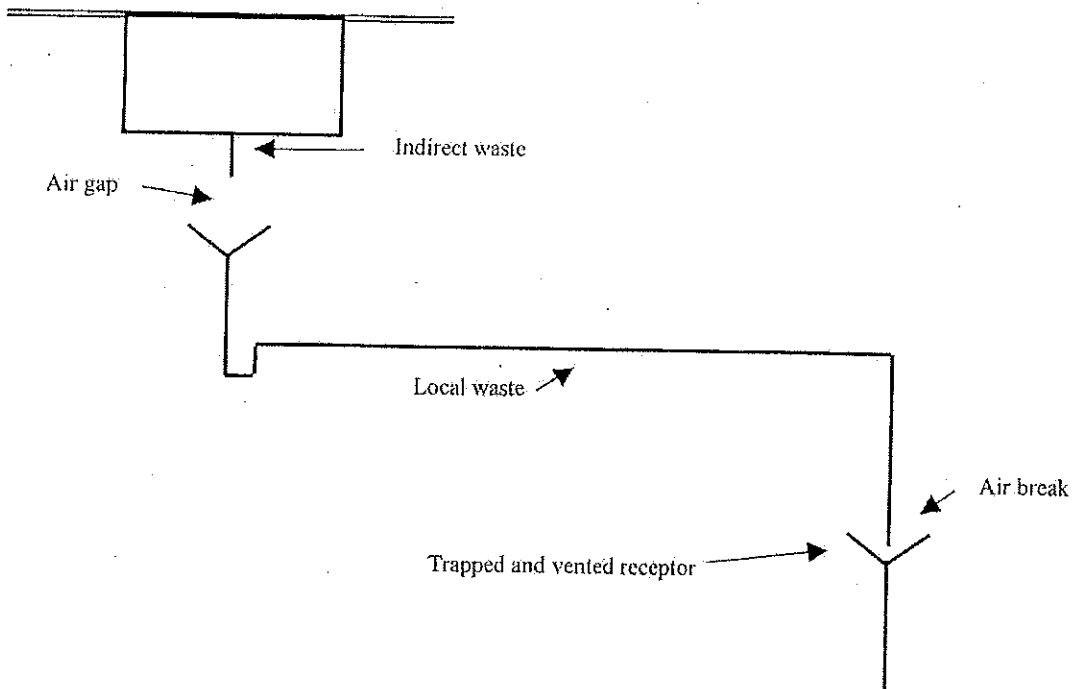
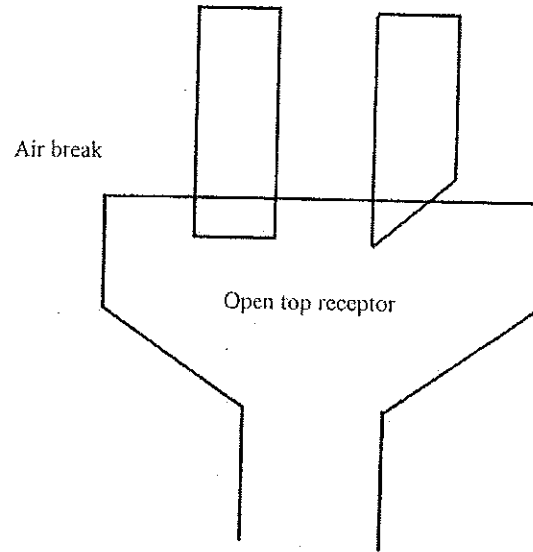
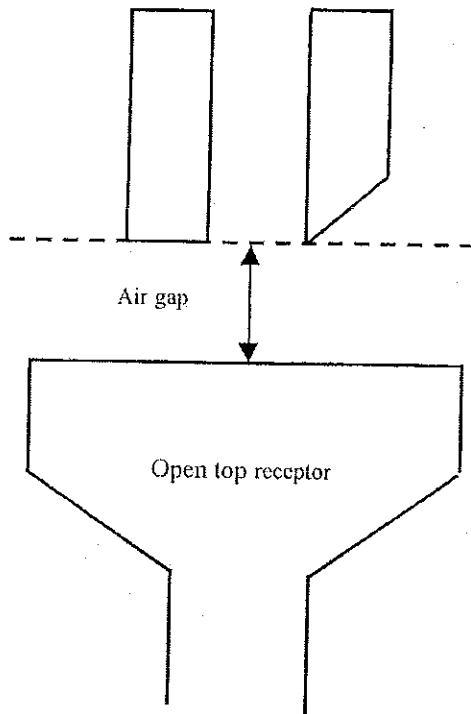

A-82.33 (8) (a) WASTE SINKS AND STANDPIPES.

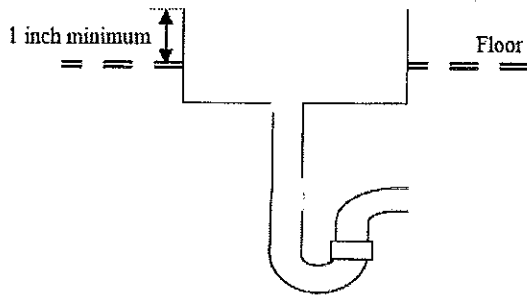

WASTE SINK IN FLOOR

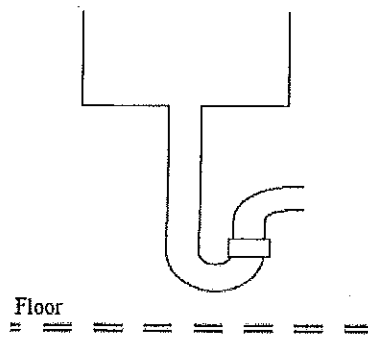

WASTE SINK ABOVE FLOOR

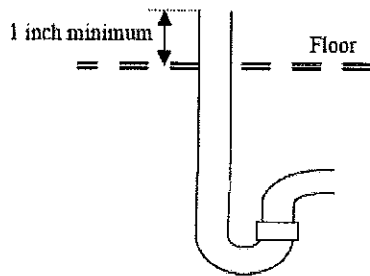

STANDPIPE IN FLOOR

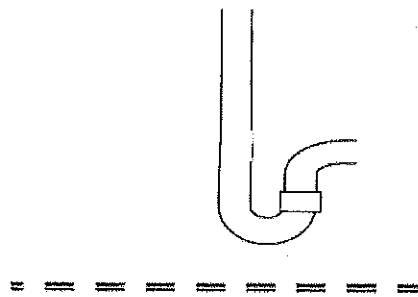

STANDPIPE ABOVE FLOOR

A-82.33 (8) (b) FLOOR SINKS.

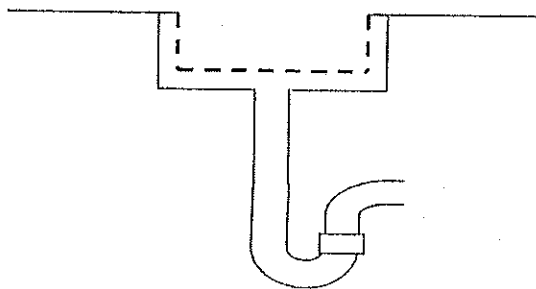

FLOOR SINK WITH BASKET

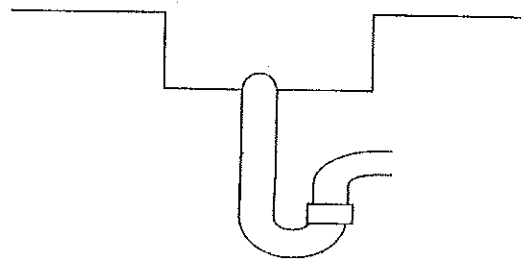

FLOOR SINK WITH DOME STRAINER

A-82.33 (8) (b) FLOOR SINK WITH GRATE OPENING.

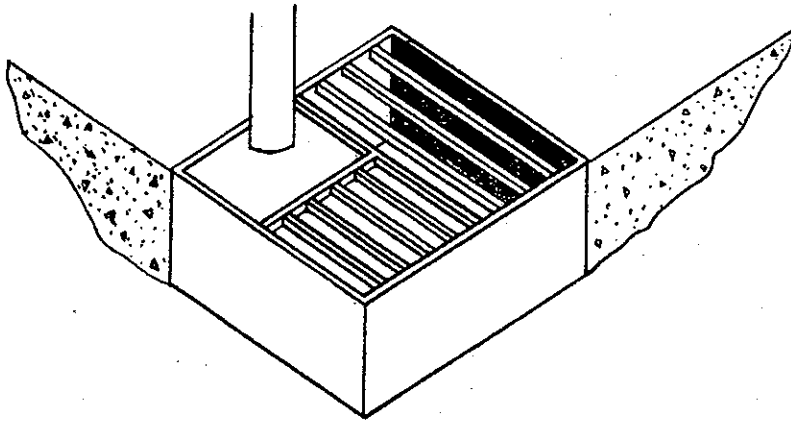

A-82.33 (8) (c)-1. LOCAL WASTE PIPING.

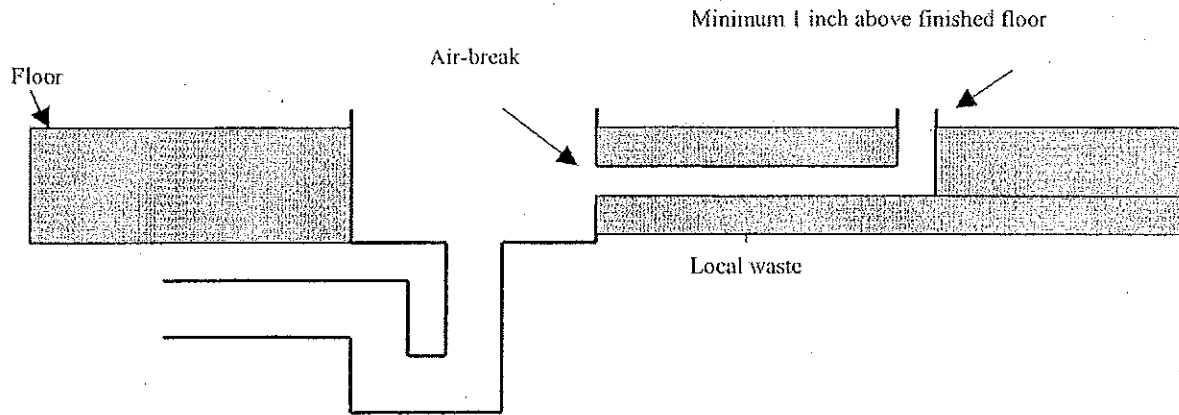

LOCAL WASTE LEADING TO A WASTE SINK, FLOOR SINK OR FLOOR DRAIN

A-82.33 (8) (c)-2. LOCAL WASTE PIPING

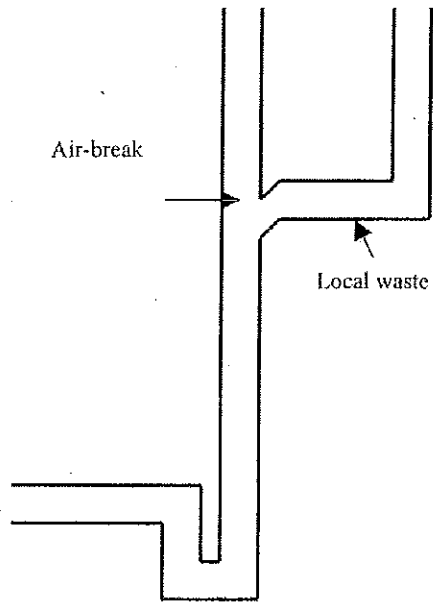

LOCAL WASTE DISCHARGING TO STANDPIPE

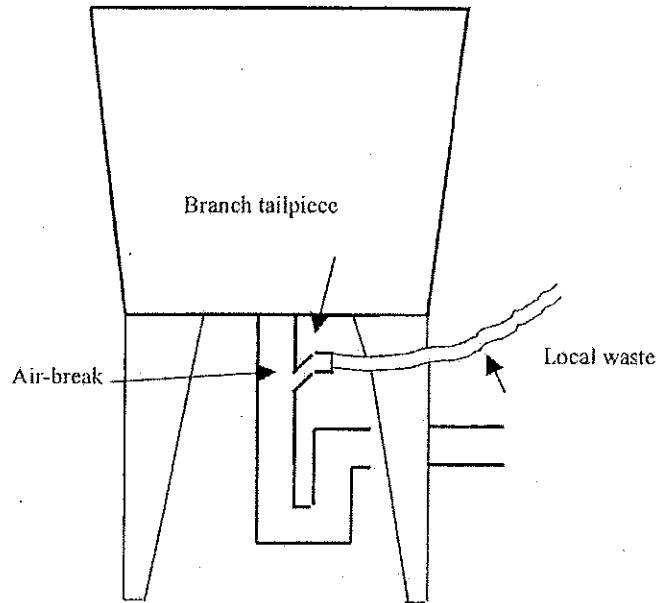

LOCAL WASTE DISCHARGING TO BRANCH TAILPIECE

A-82.33 (8) (d)-1. LOCAL WASTE PIPING SERVING WATER HEATER TEMPERATURE AND PRESSURE RELIEF VALVES.

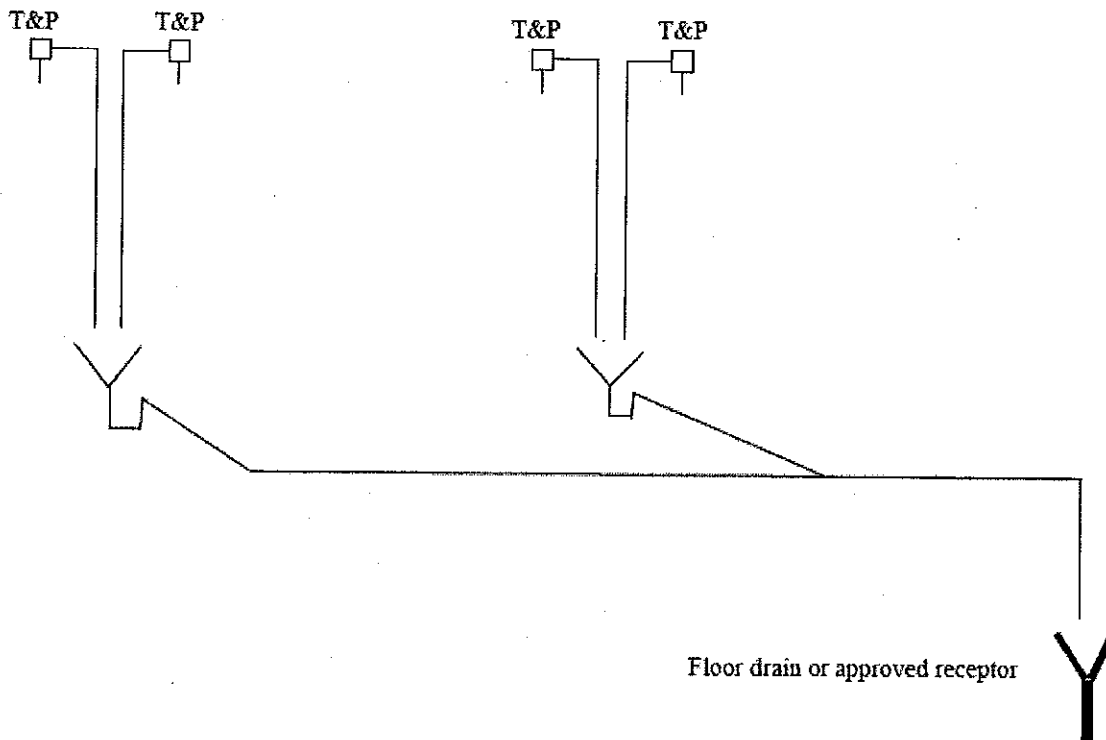

A-82.33 (8) (d)-2. LOCAL WASTE PIPING SERVING WATER HEATER TEMPERATURE AND PRESSURE RELIEF VALVES

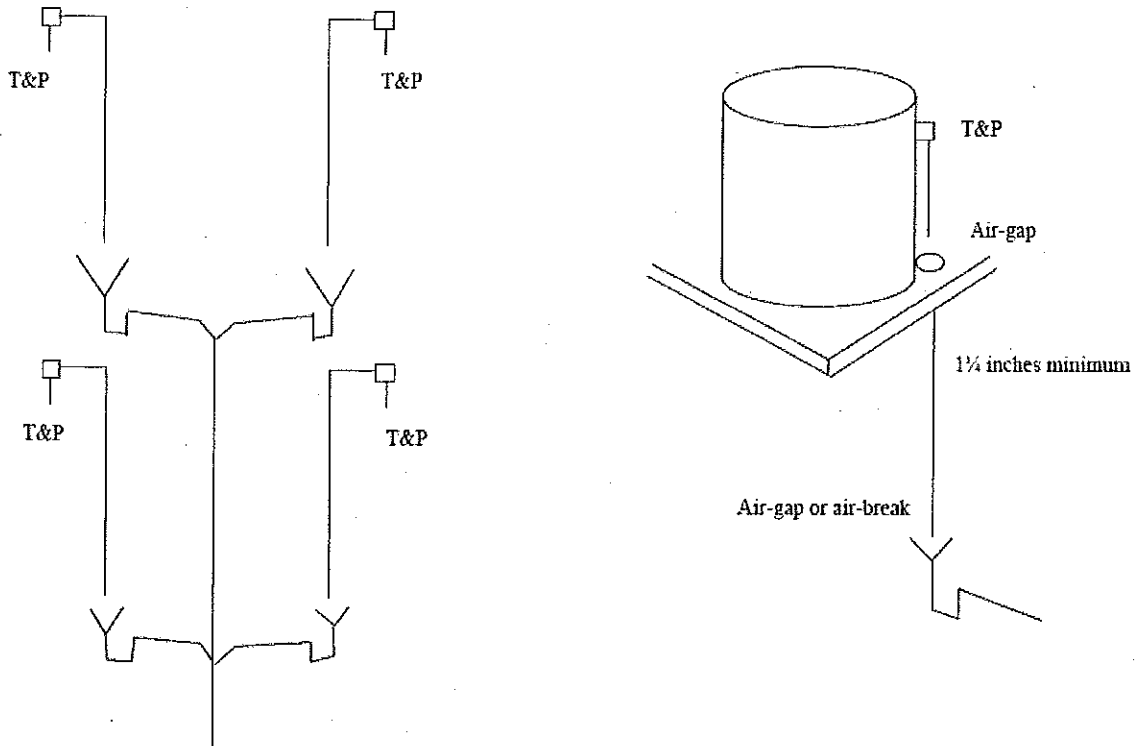

A-82.33 (9) (c) COMMERCIAL GRAVITY DISCHARGE-TYPE CLOTHES WASHERS.

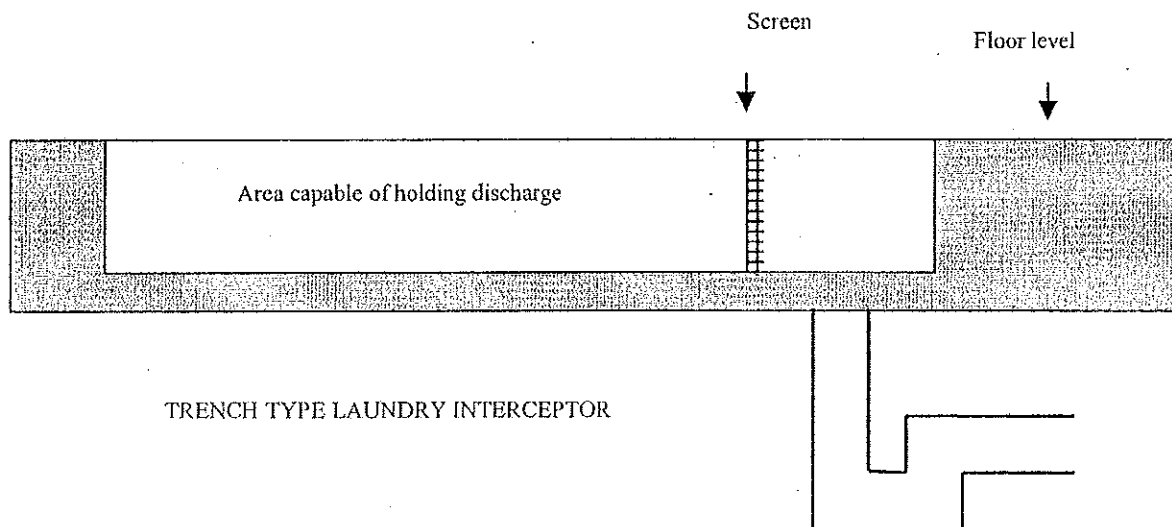

A-82.33 (9) (d)-1. RESIDENTIAL-TYPE CLOTHES WASHERS.

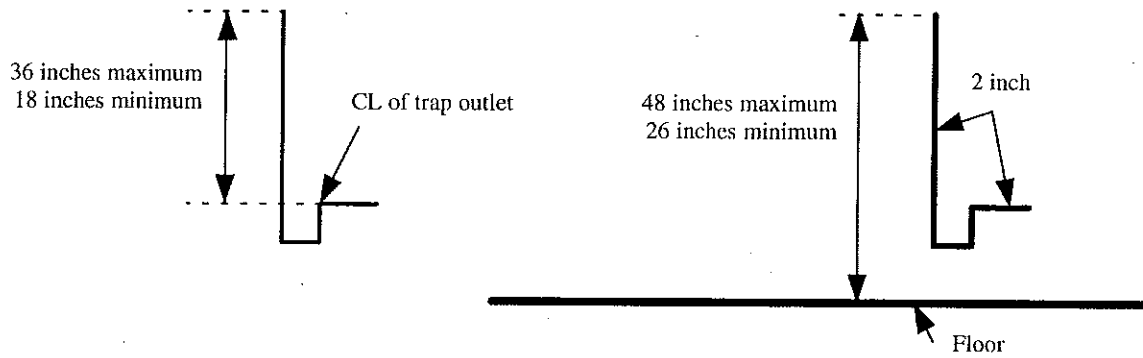

WASHER STANDPIPE RECEPTORS

A-82.33 (9) (d)-2. RESIDENTIAL-TYPE DISHWASHERS.

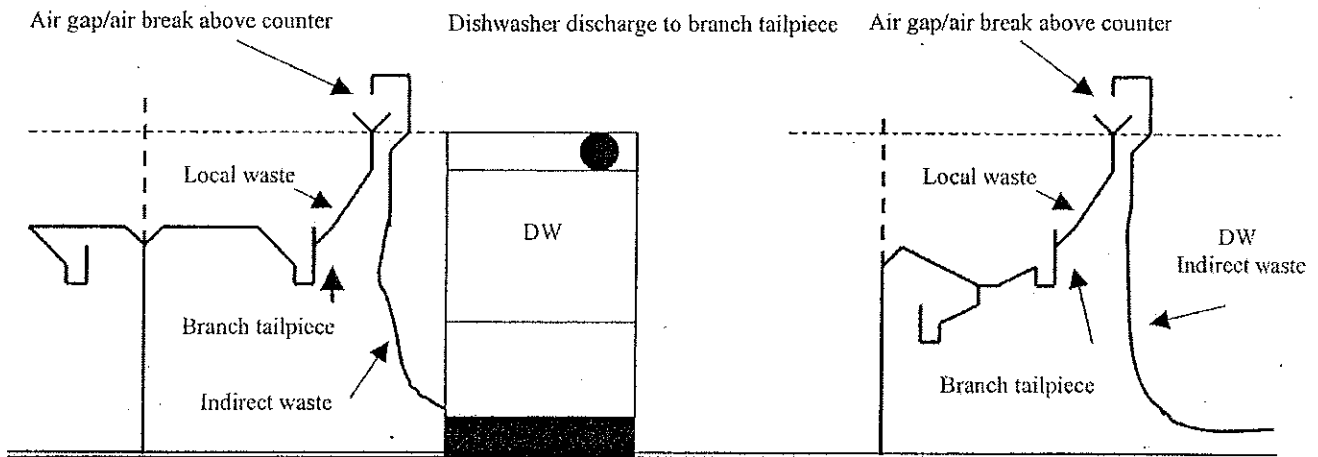

KITCHEN SINK WITH OR WITHOUT FOOD WASTE GRINDER

KITCHEN SINK WITH OR WITHOUT FOOD WASTE GRINDER

A-82.33 (9) (d)-3. RESIDENTIAL-TYPE DISHWASHERS

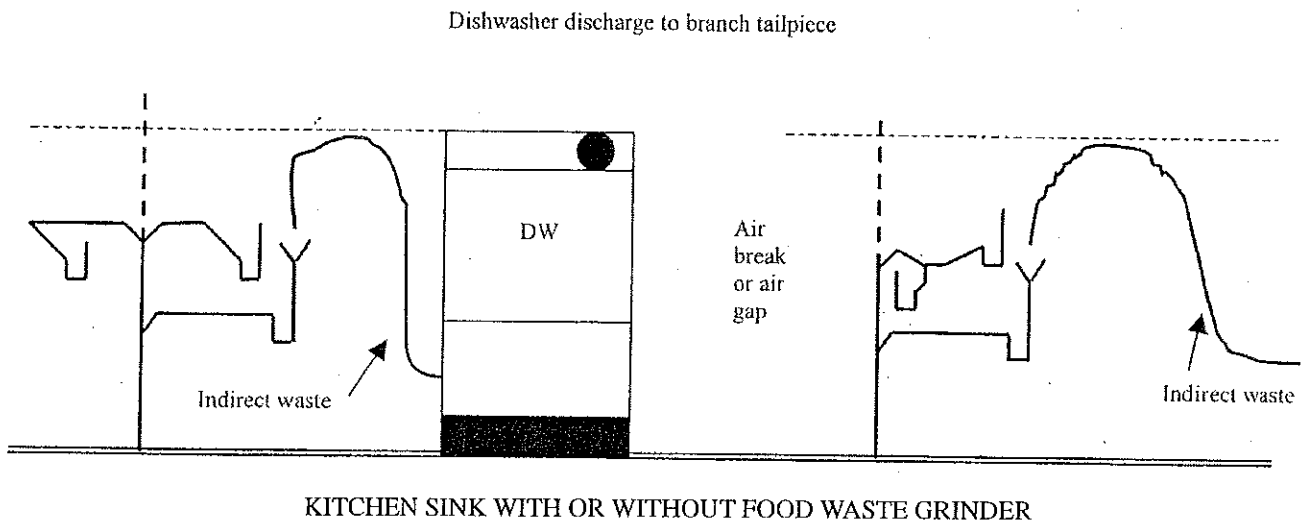

A-82.33 (9) (d)-4. COMMERCIAL DISHWASHERS.

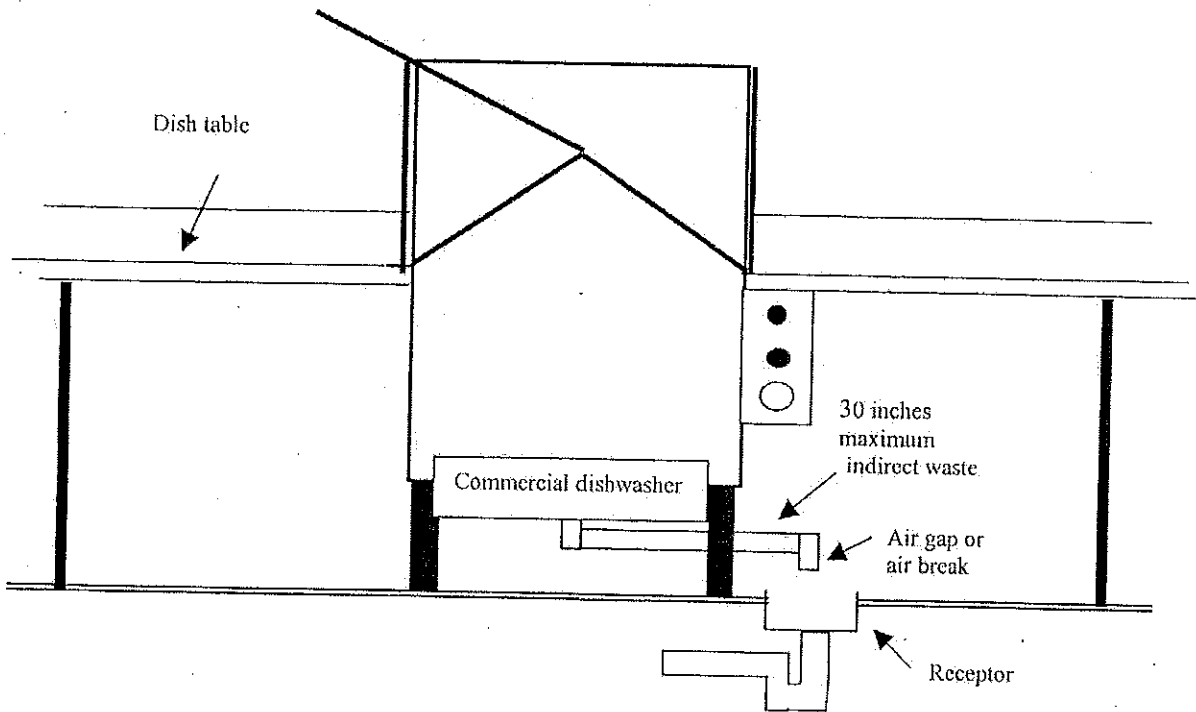

A-82.33 (9) (f)-1. ELEVATOR PIT SUBSIDIARY FLOOR DRAINS. Drains and sumps complying with ss. Comm 82.33 and 82.36 shall be provided.

Note: Section Comm 18.23 includes requirements for the installation of drains and sumps. Section Comm 18.23 reads: "Drains and sumps complying with ss. Comm 82.33 and 82.36 shall be provided. Drains connected directly to sanitary drain systems shall not be installed in elevator pits."

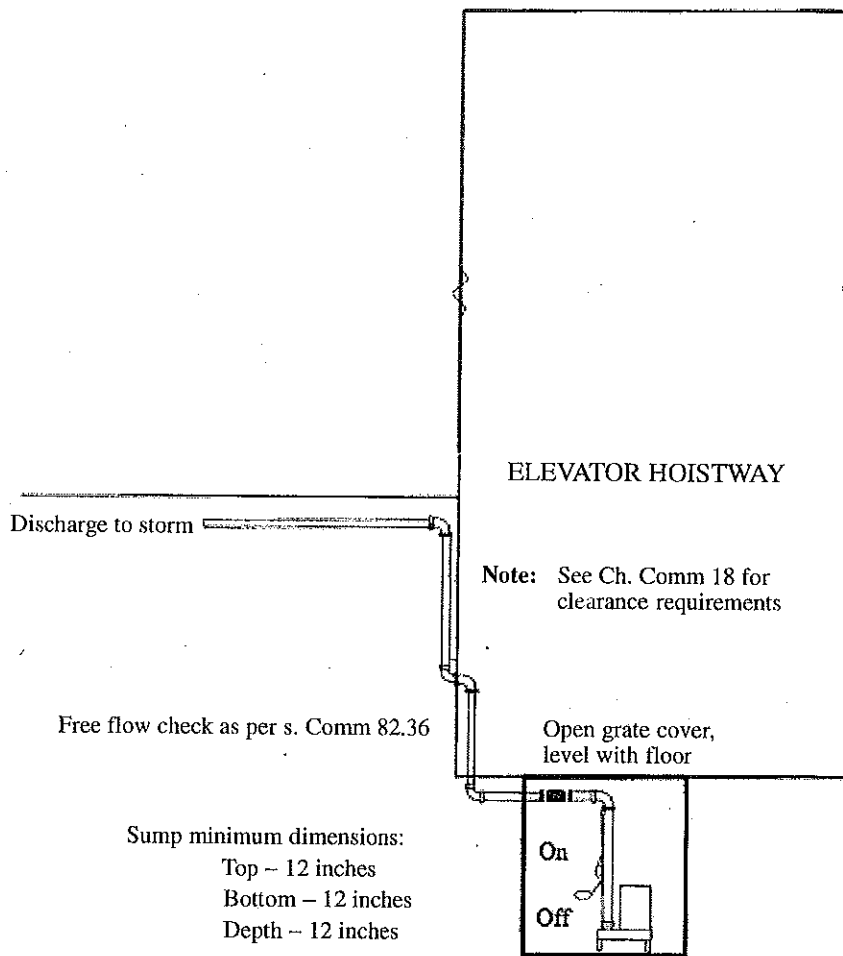

A-82.33 (9) (f)-2. ELEVATOR PIT SUBSOIL AND FLOOR DRAINS.

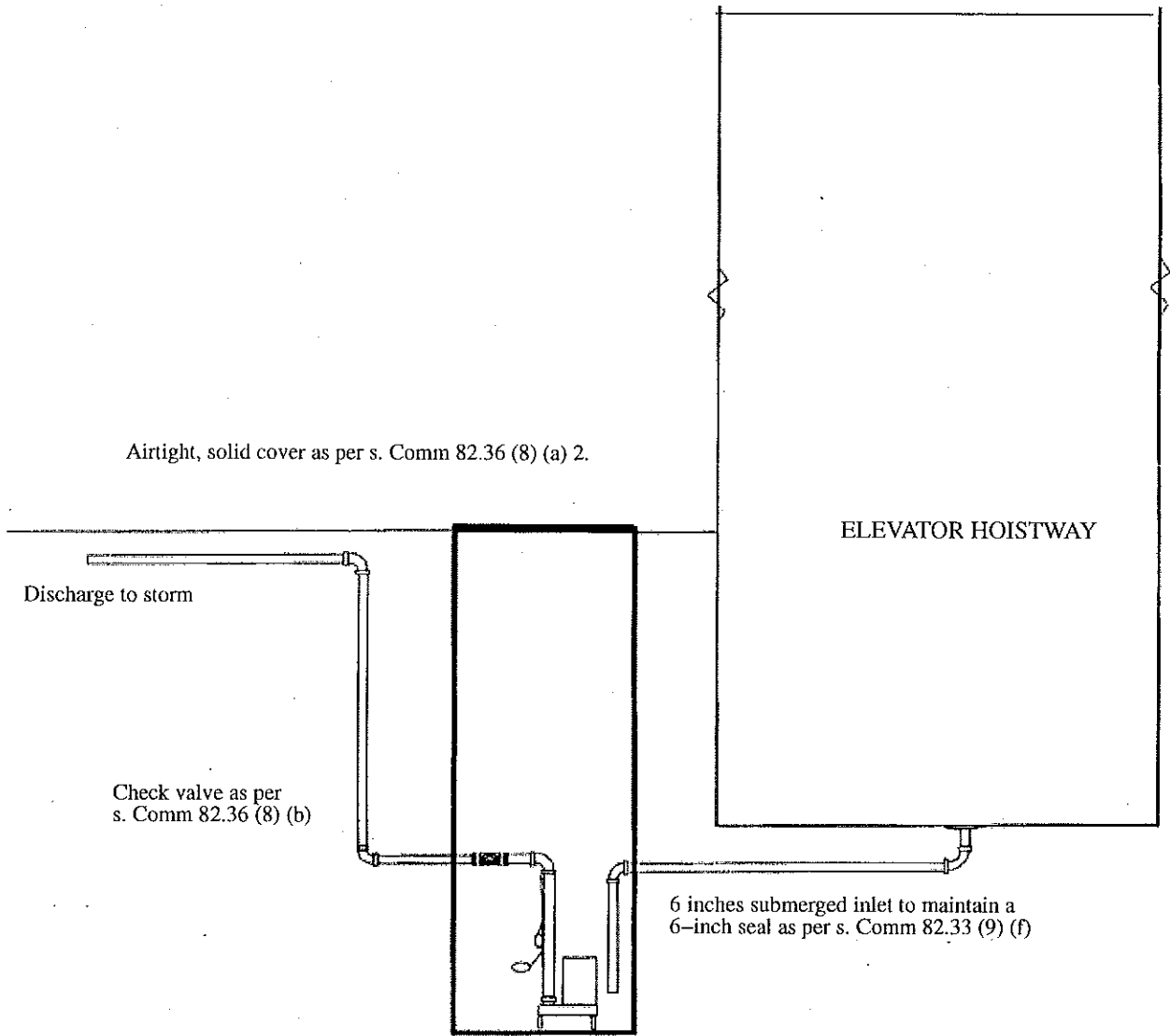

ELEVATOR DRAIN DISCHARGE - STORM DRAIN CONNECTION

A-82.33 (9) (g) 1. BAR AND SODA FOUNTAIN SINKS.

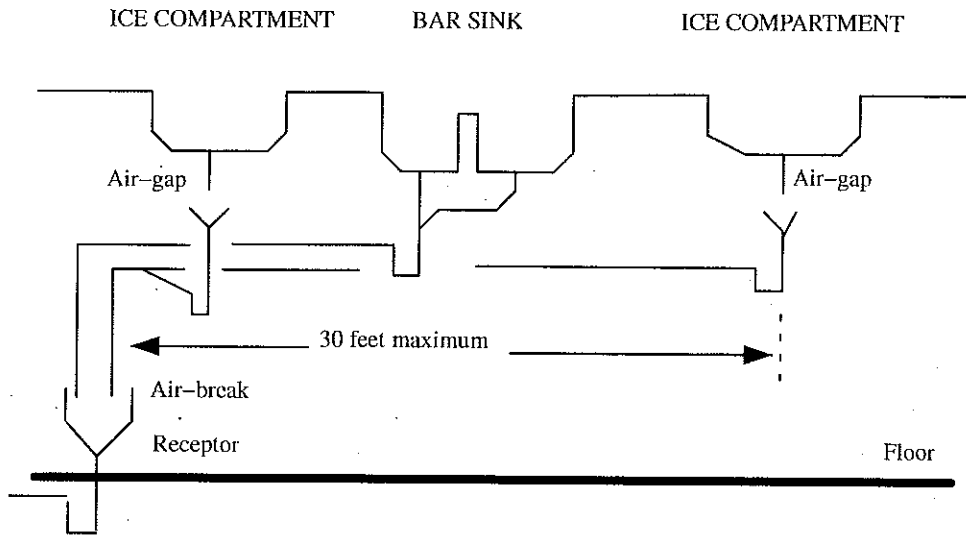

A-82.33 (9) (g) 2. BEER TAPS, COFFEE MAKERS, GLASS FILLERS AND SODA DISPENSERS.

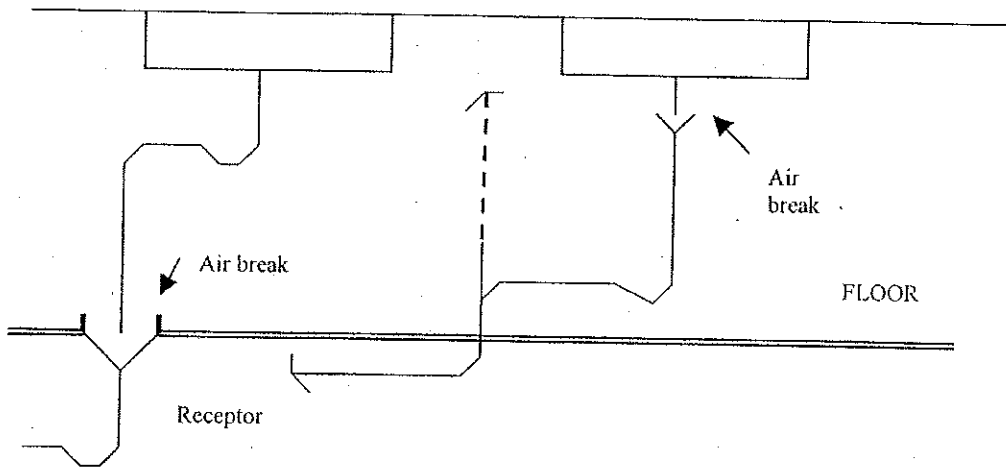

A-82.33 (9) (g) 3. NOVELTY BOXES AND ICE COMPARTMENTS AND ICE CREAM DIPPER WELLS.

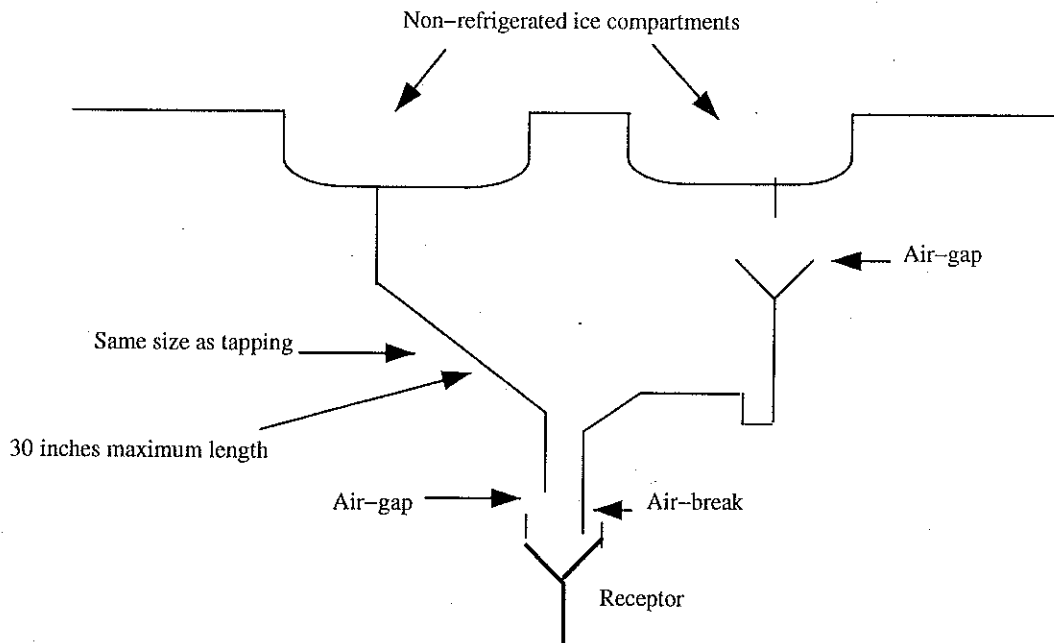
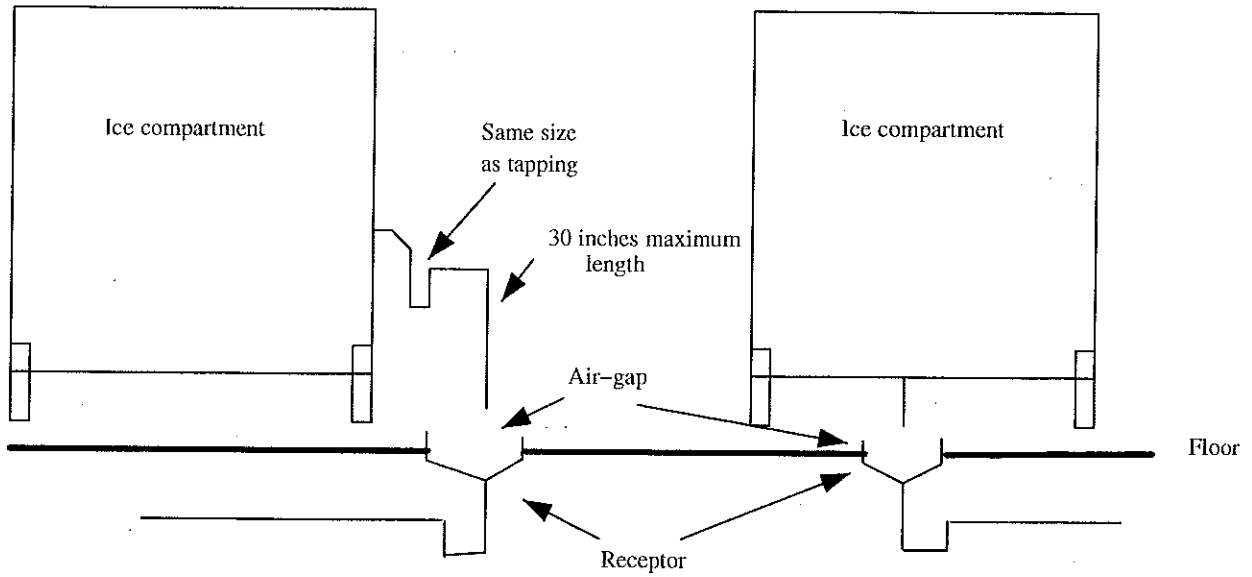

A-82.33 (9) (g) 4. REFRIGERATED FOOD STORAGE ROOMS, COMPARTMENTS AND DISPLAY CASES.

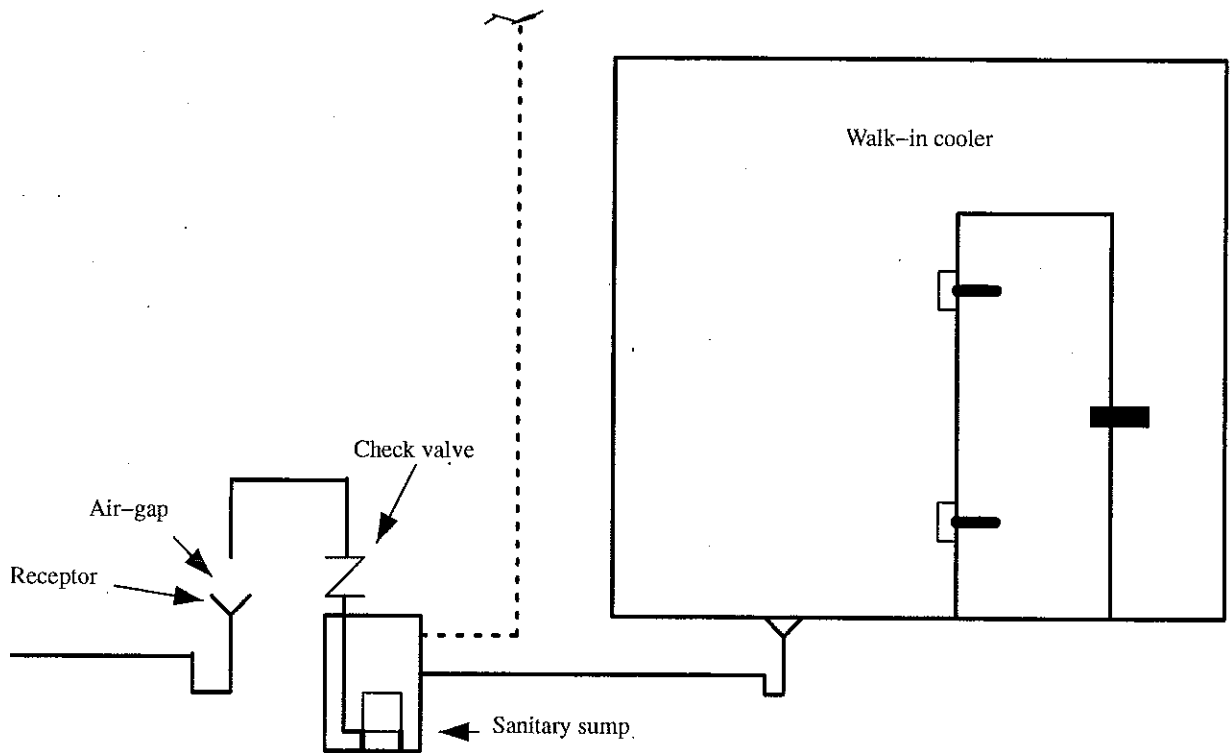
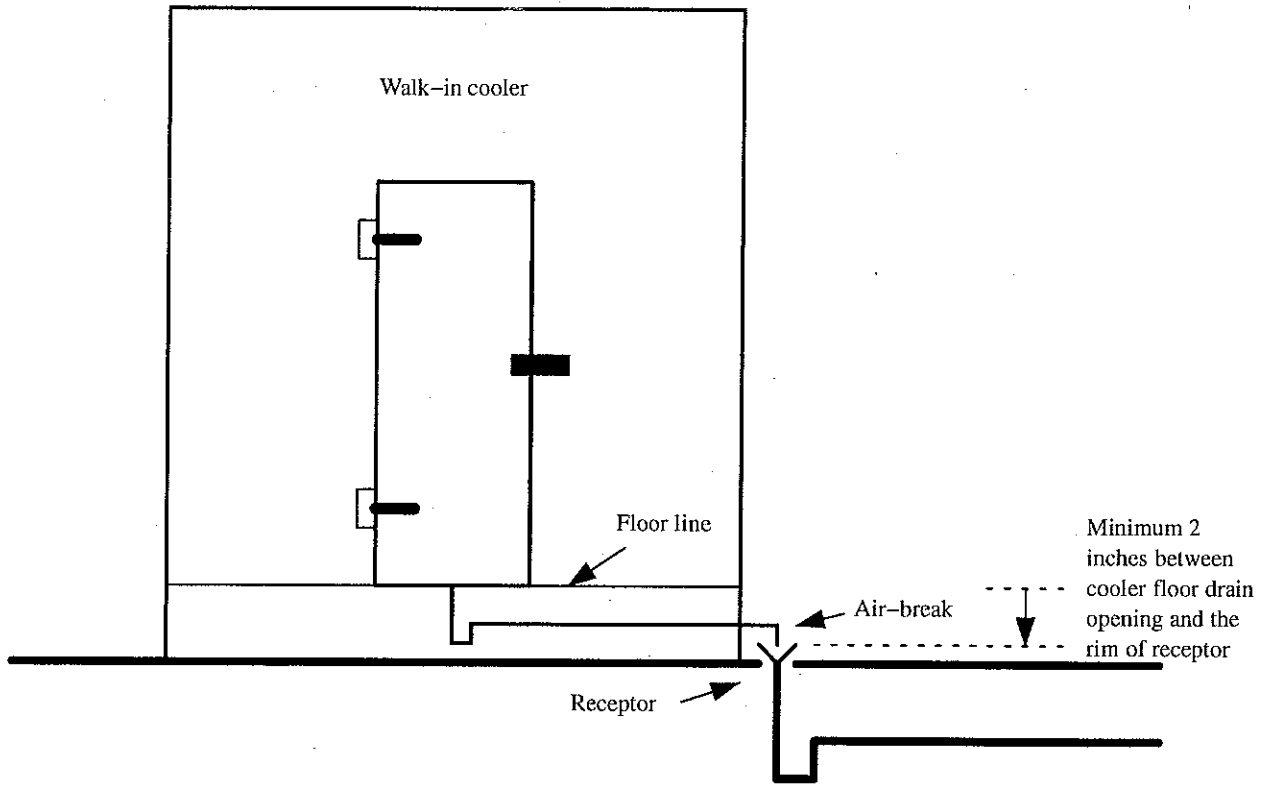

A-82.33 (9) (g) 5. MISCELLANEOUS FOOD HANDLING EQUIPMENT.

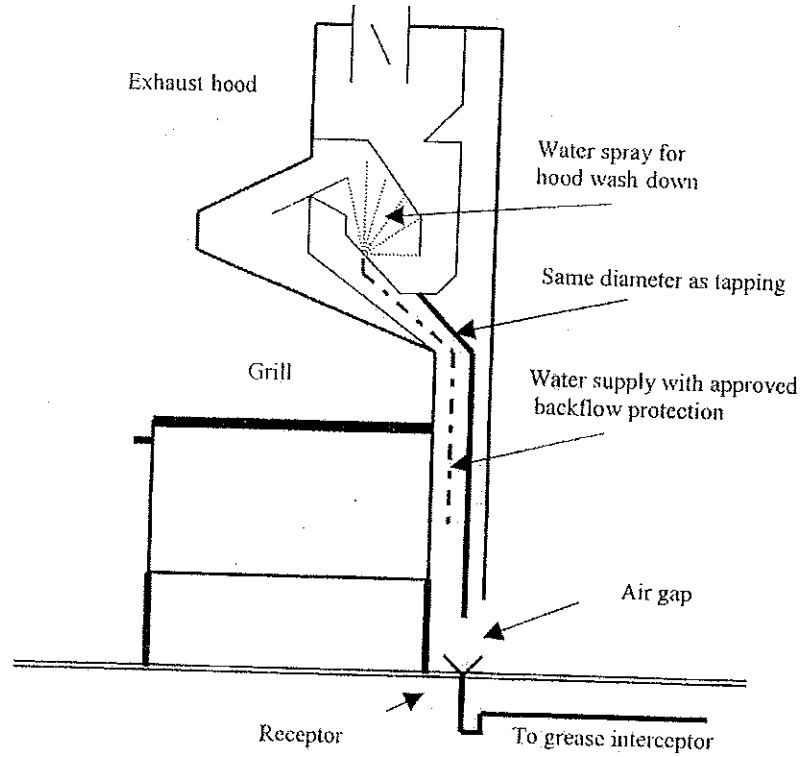

A-82.33 (9) (g) 5. MISCELLANEOUS FOOD HANDLING EQUIPMENT.

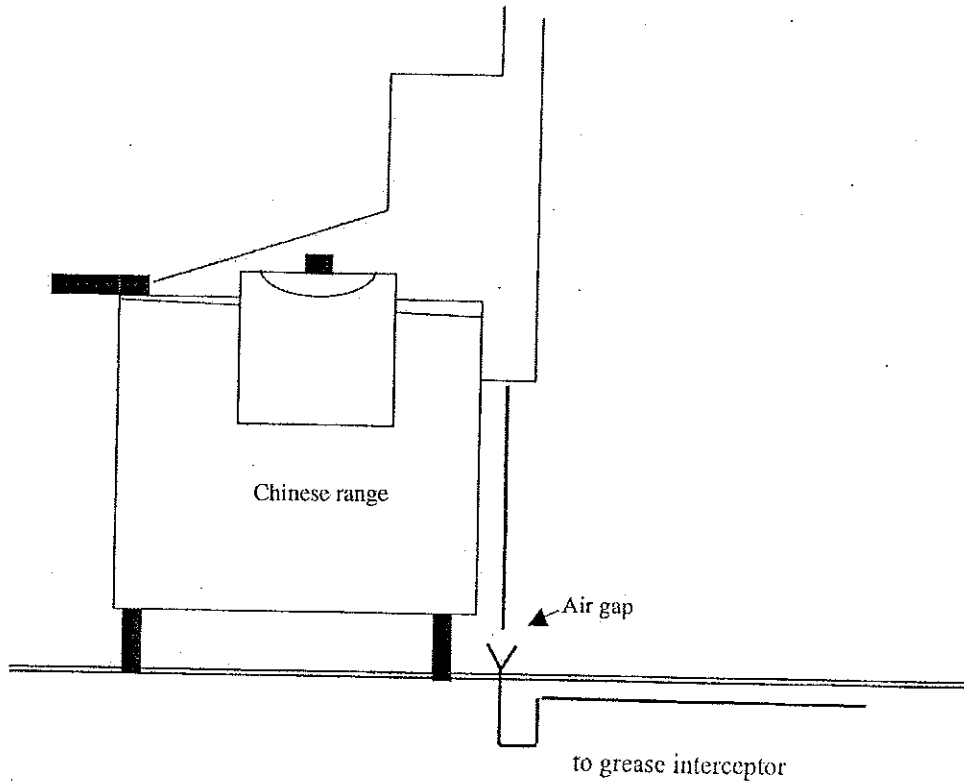

A-82.34 (4)-1. GARAGE CATCH BASINS.

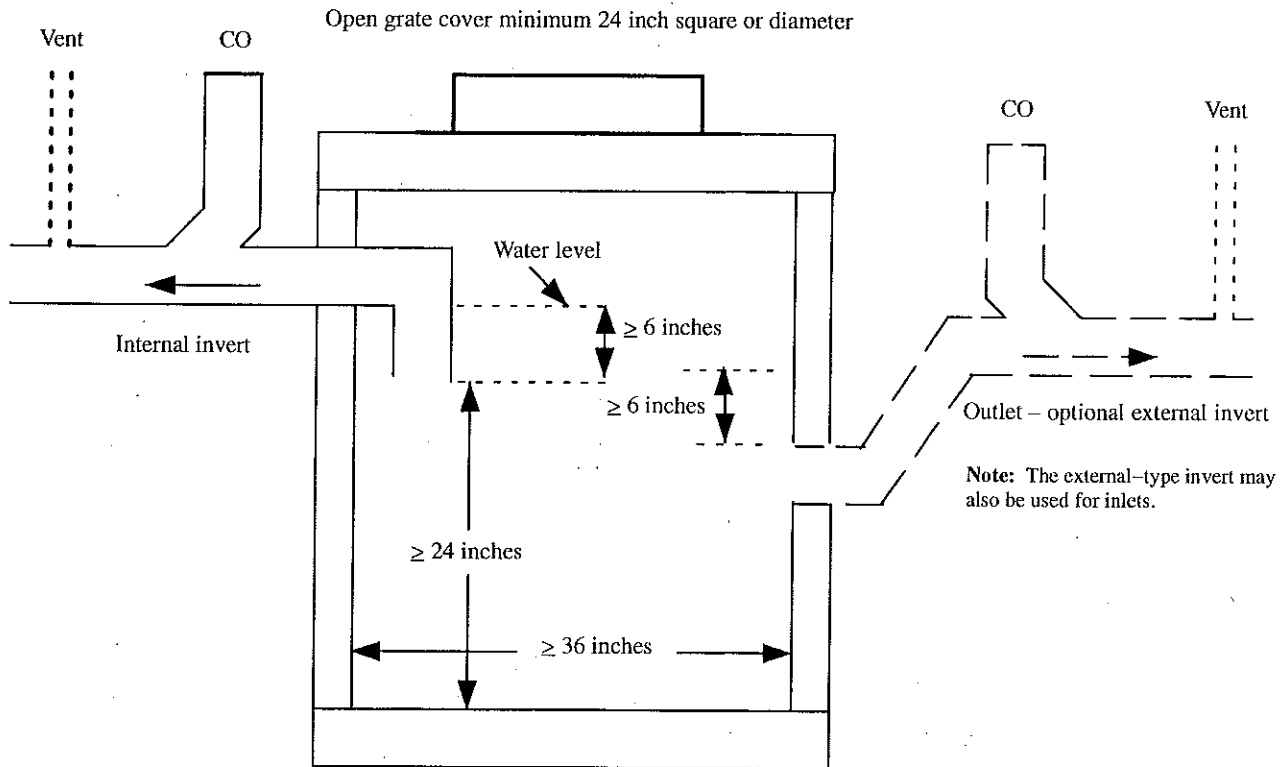

A-82.34 (4)-2. TRAPPED FIXTURES DISCHARGING TO CATCH BASIN.

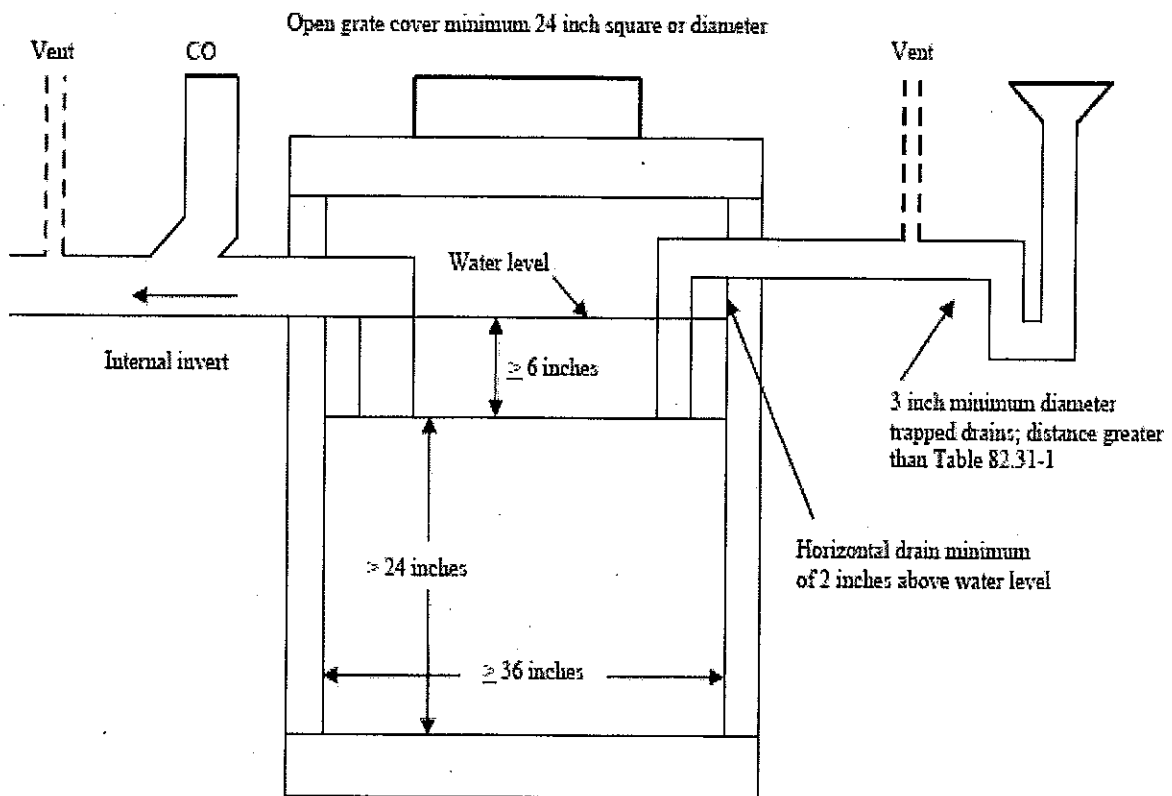

A-82.34 (4)-3. TRAPPED FIXTURE DISCHARGING INTO GARAGE CATCH BASIN.

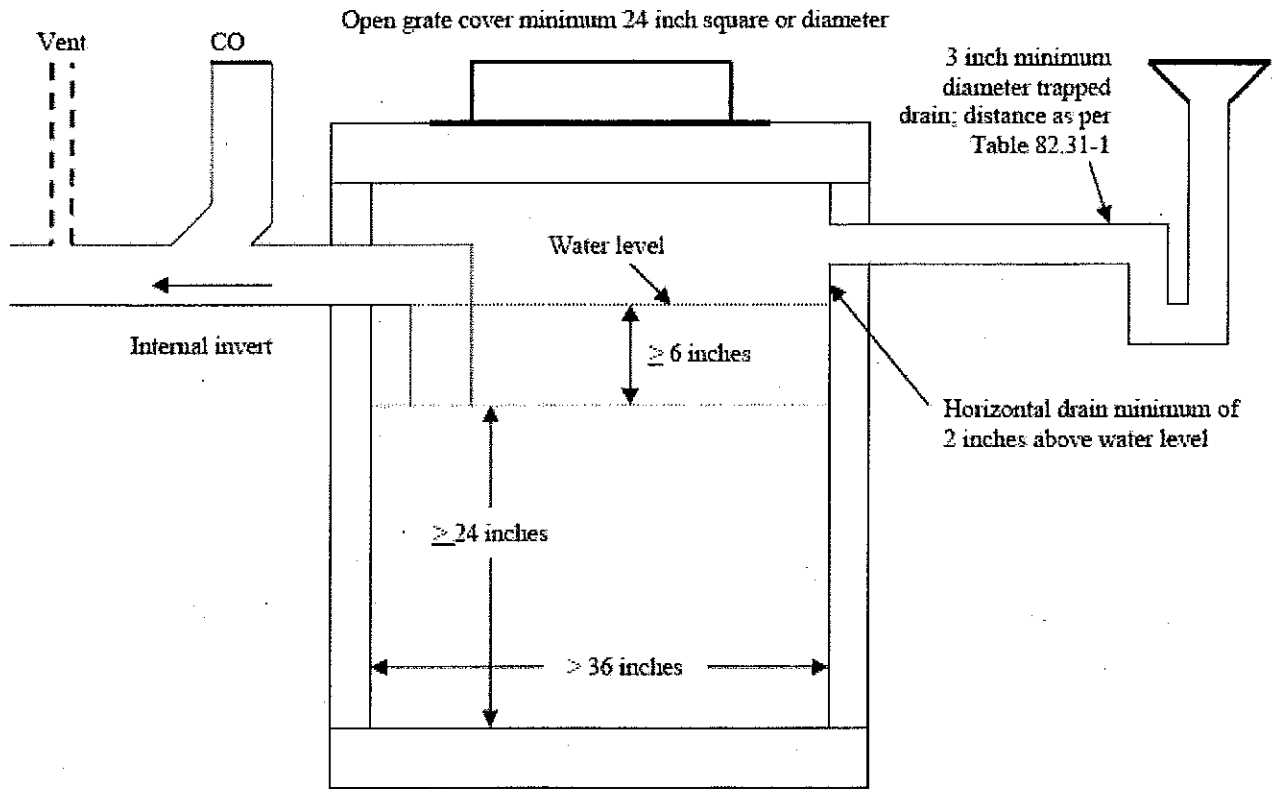

A-82.34 (4)-4. FIXTURES WITHOUT TRAPS DISCHARGING TO CATCH BASIN.

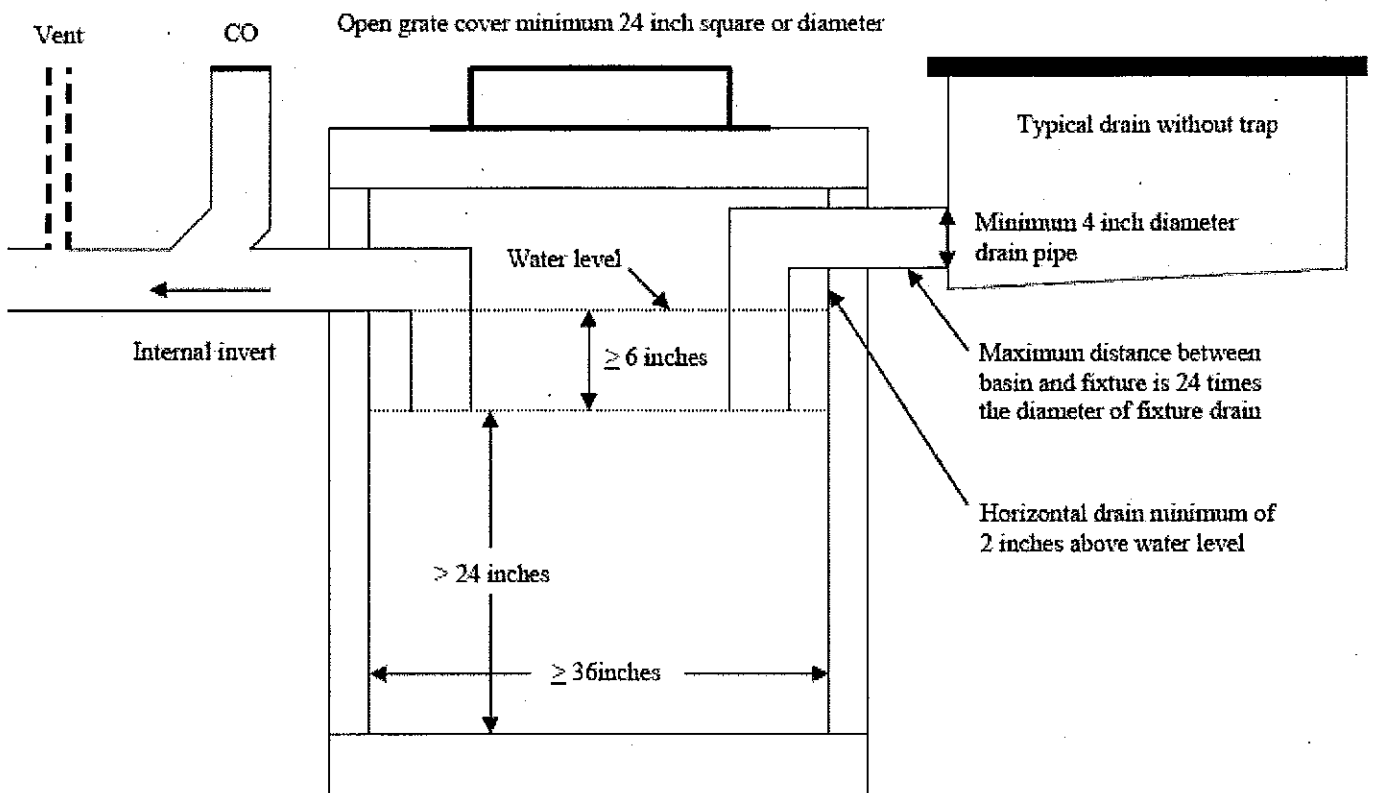

A-82.34 (4)-5. GARAGE CATCH BASIN WITH FIXTURES ON SEPARATE FLOOR LEVELS.

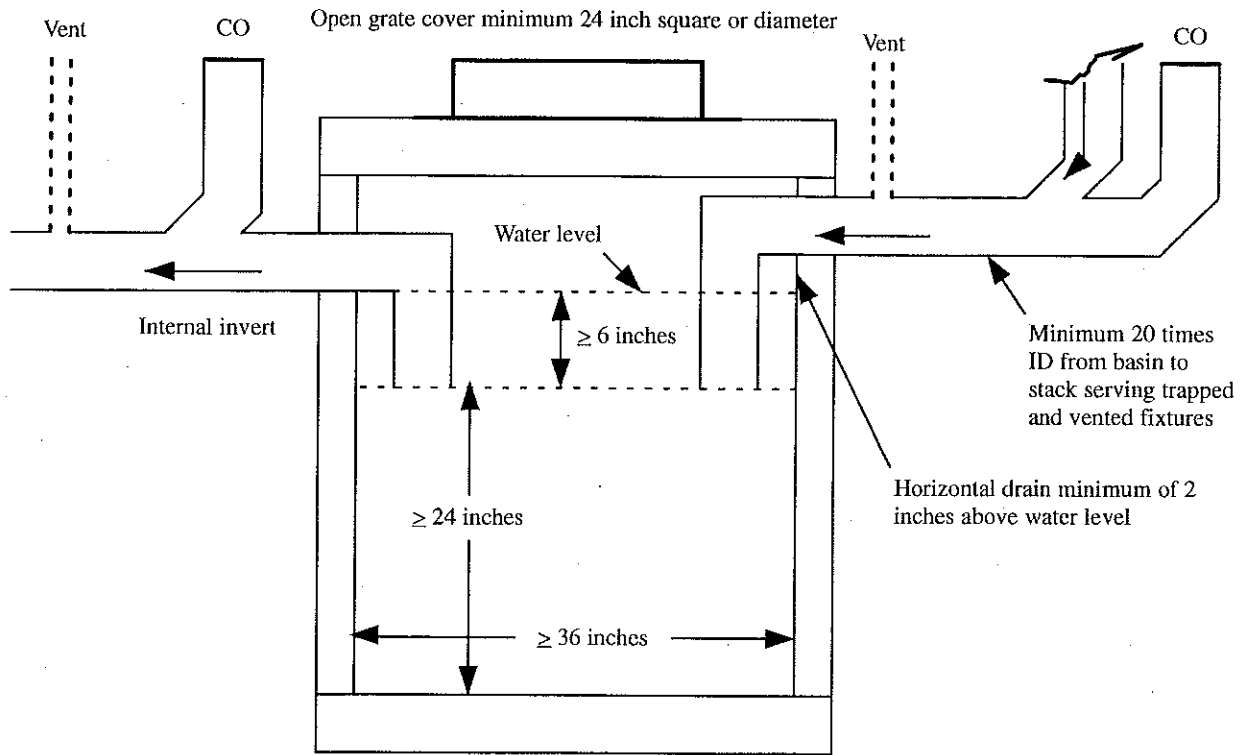

A-82.34 (4)-6. GARAGE CATCH BASIN RECEIVING PRESSURIZED DRAINS.

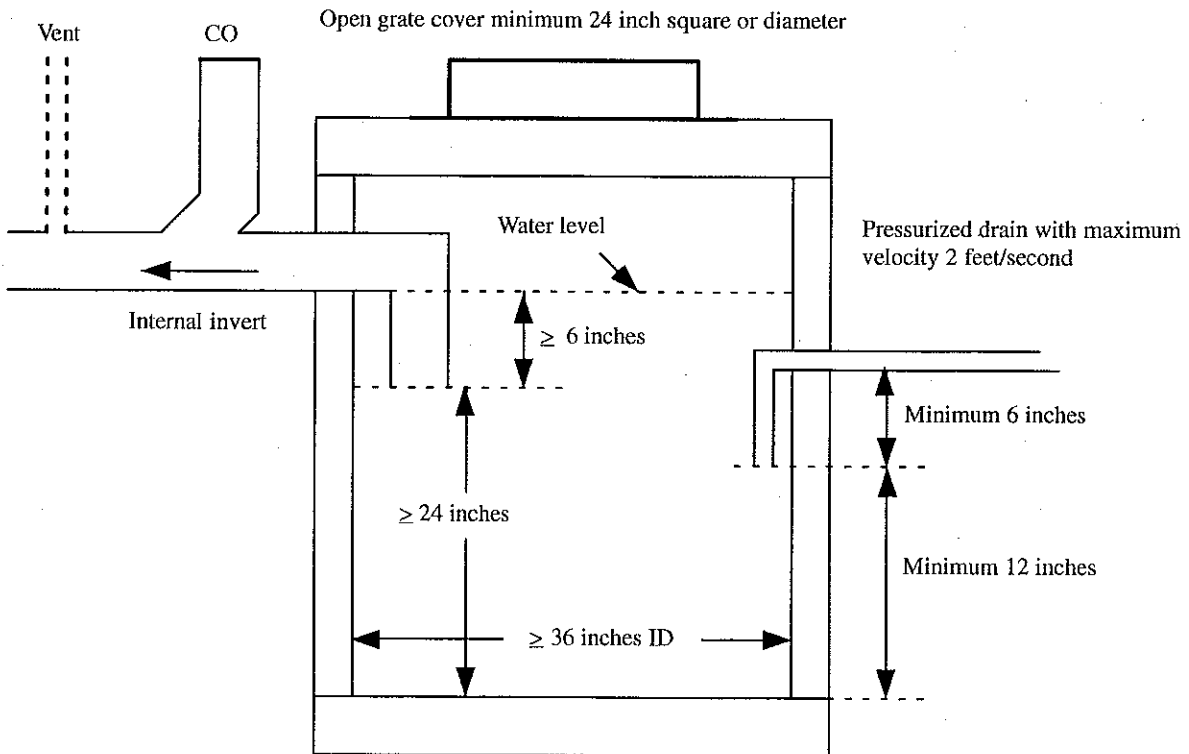

A-82.34 (5) (b)-1. EXTERIOR GREASE INTERCEPTORS.

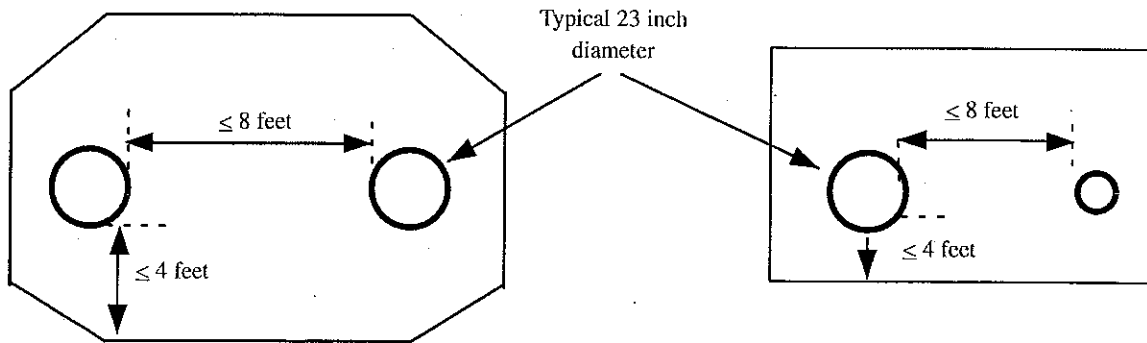

GREASE INTERCEPTOR MANHOLE LOCATION

A-82.34 (5) (b)-2. EXTERIOR GREASE INTERCEPTORS.

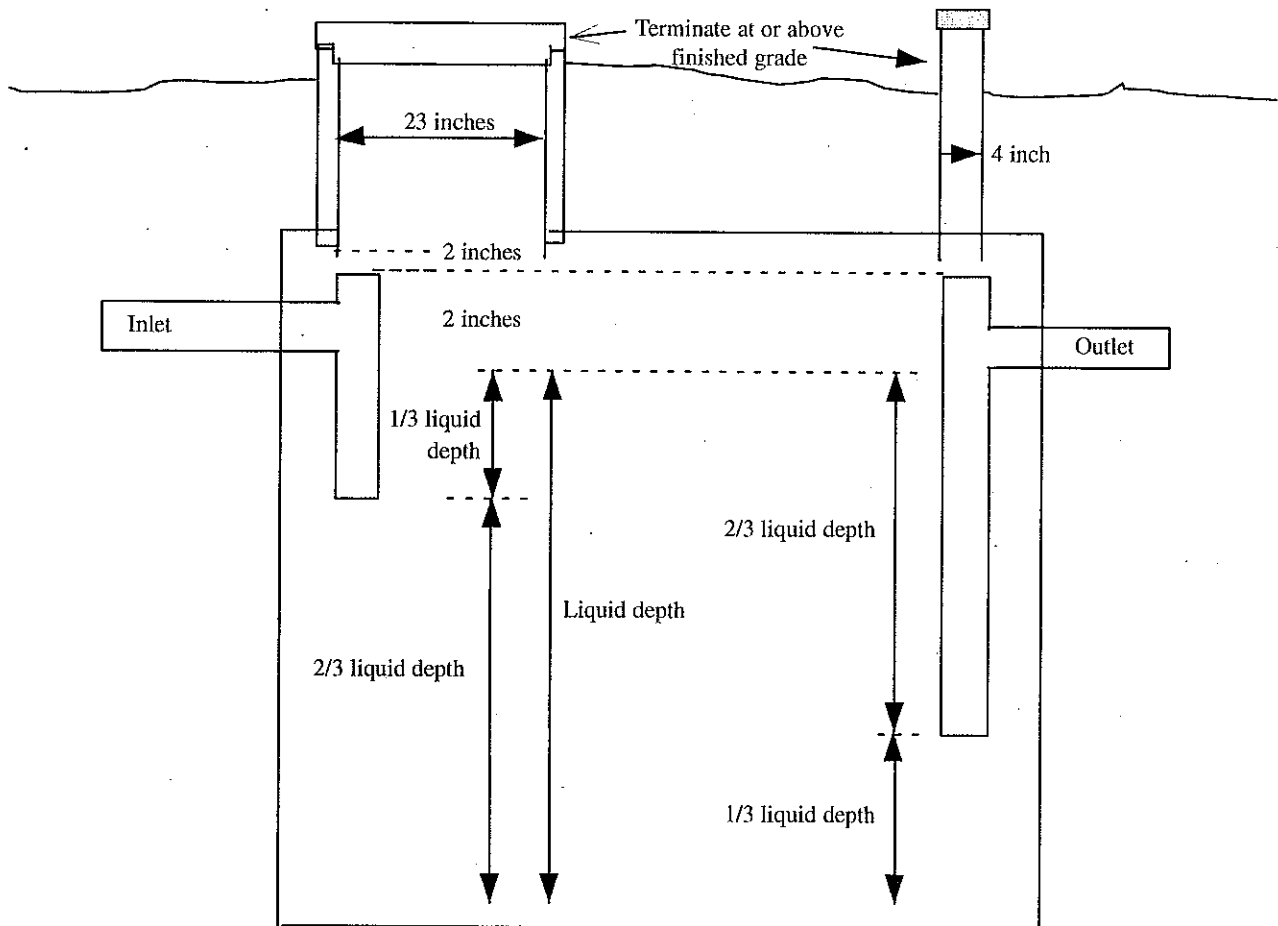

A-82.34 (5) (c) INTERIOR GREASE INTERCEPTORS.

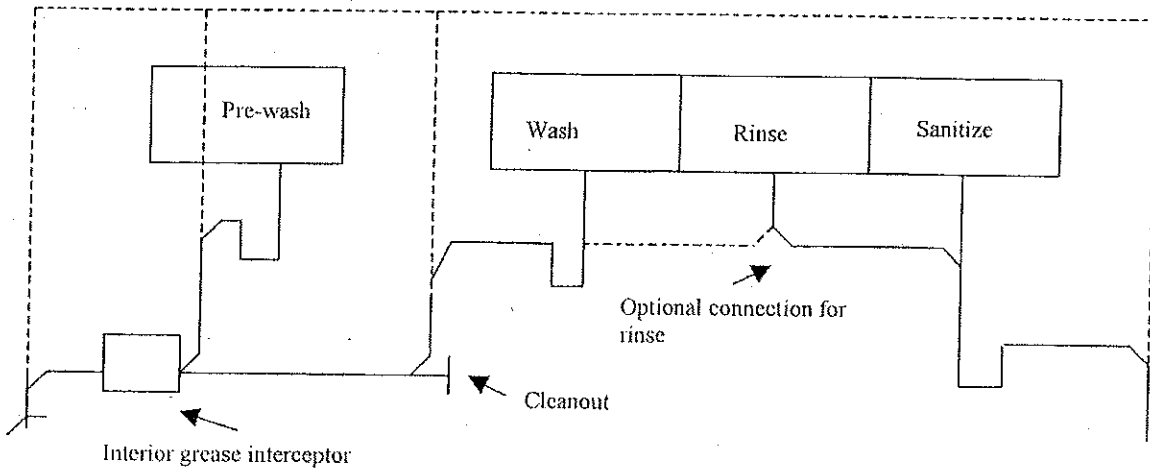

PRE-WASH AND 3-COMPARTMENT SCULLERY SINK

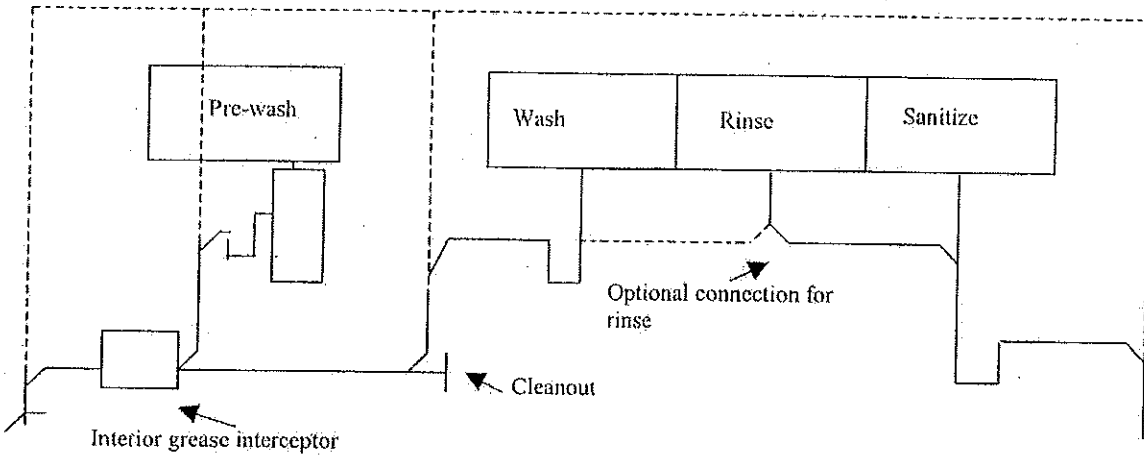

PRE-WASH WITH DISPOSAL AND 3-COMPARTMENT SCULLERY SINK

A-82.34 (6) AUTOMATIC CAR WASHES.

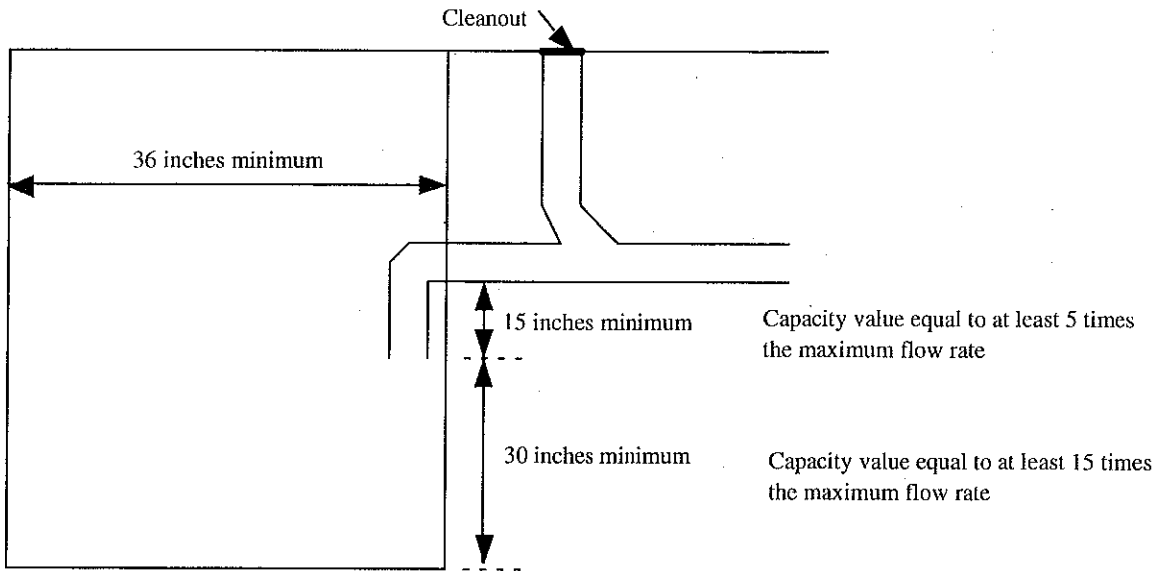

CAR WASH INTERIOR WITH INVERT INSIDE OF BASIN

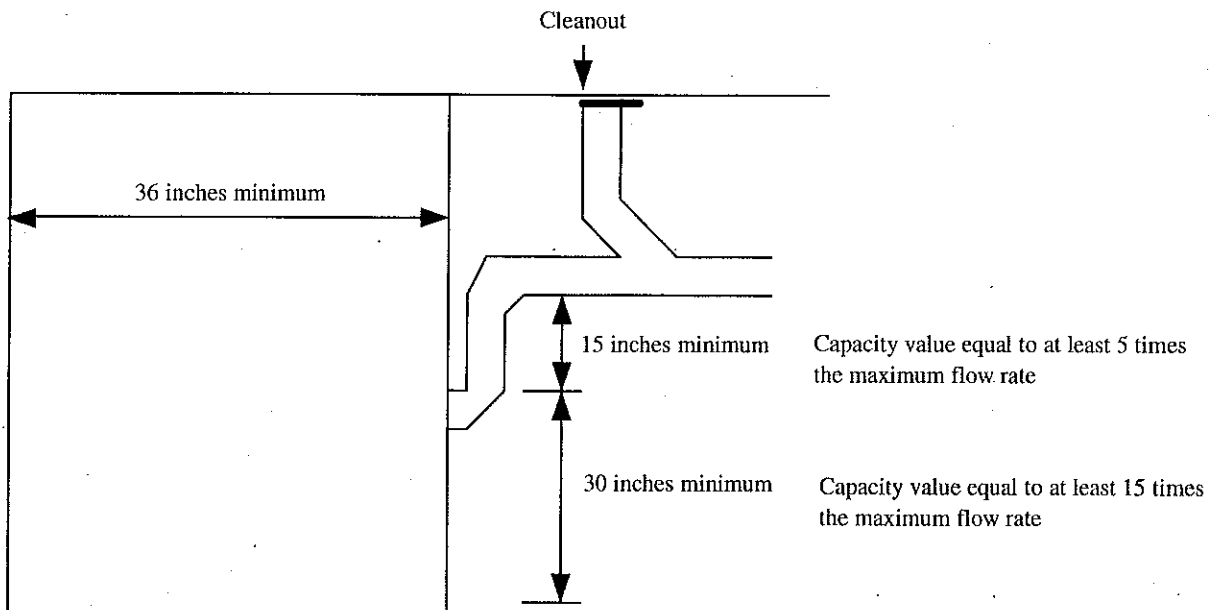

CAR WASH INTERIOR WITH INVERT OUTSIDE OF BASIN

A-82.34 (7) COMMERCIAL LAUNDRIES. See also A-82.33 (9)-4. for trench type interceptors.

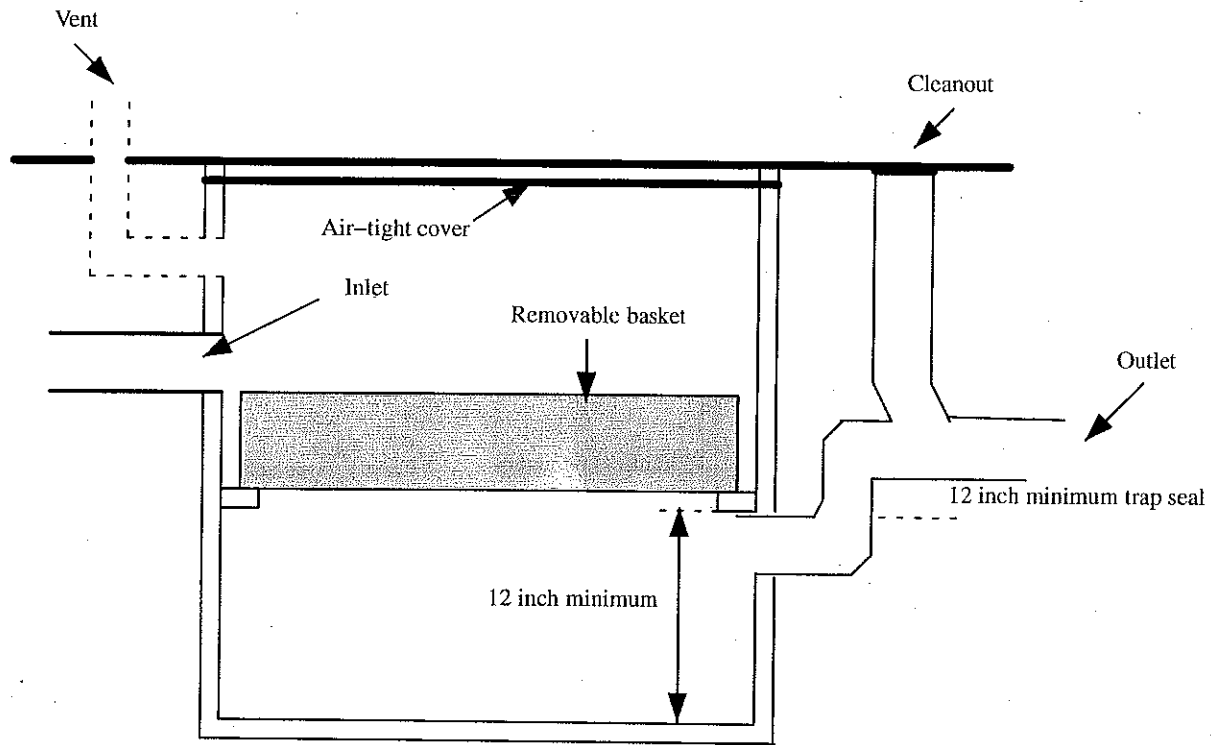

IN LINE LAUNDRY INTERCEPTOR

A-82.34 (8) OIL AND FLAMMABLE LIQUIDS INTERCEPTOR. Vents as shown must terminate independently.

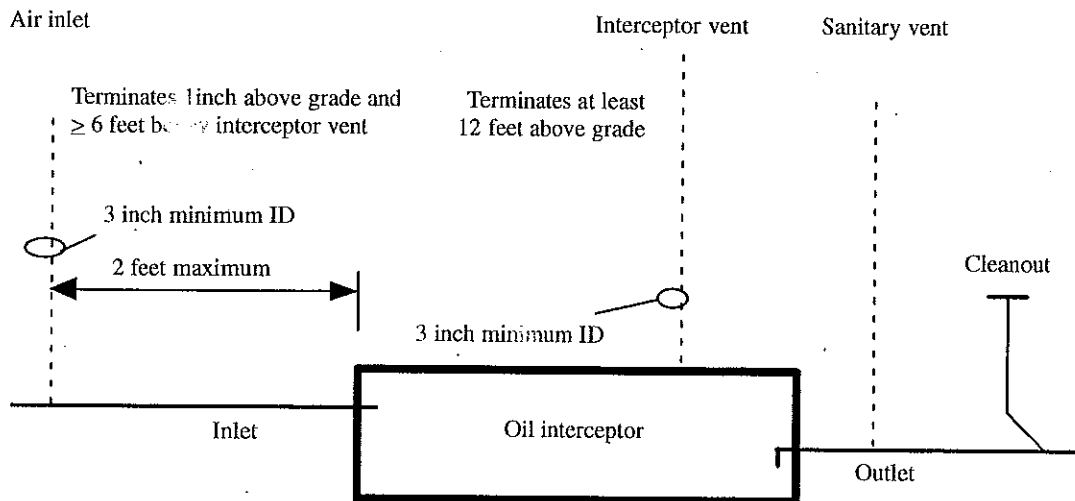

A-82.34 (13) PLASTER AND HEAVY SOLIDS TRAP TYPE INTERCEPTORS.

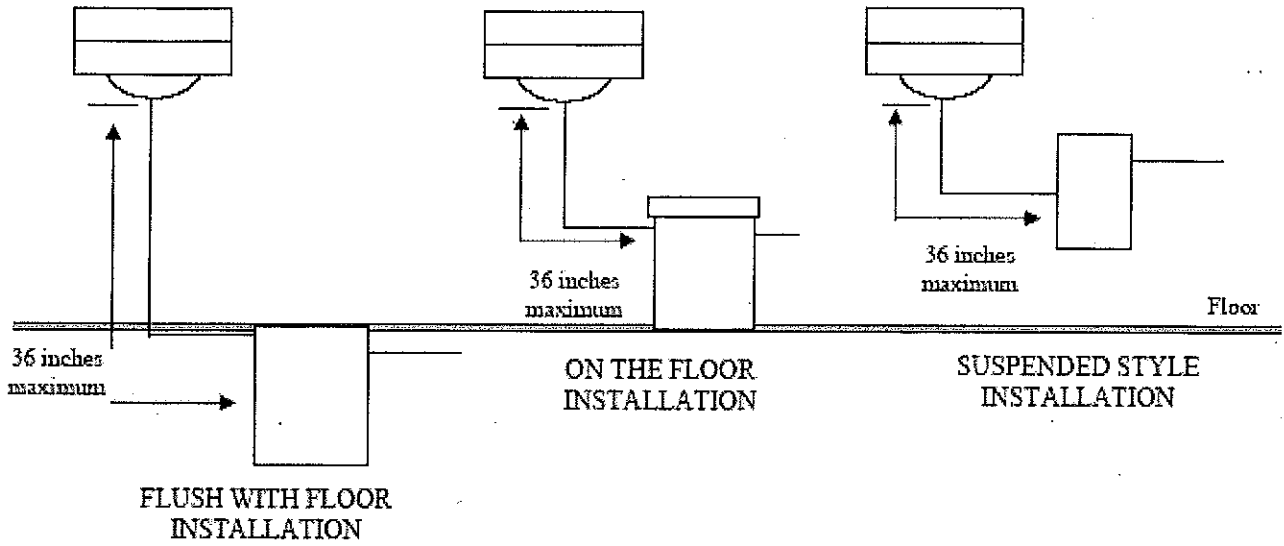

A-82.34 (14) CHEMICAL DILUTION AND NEUTRALIZING BASINS.

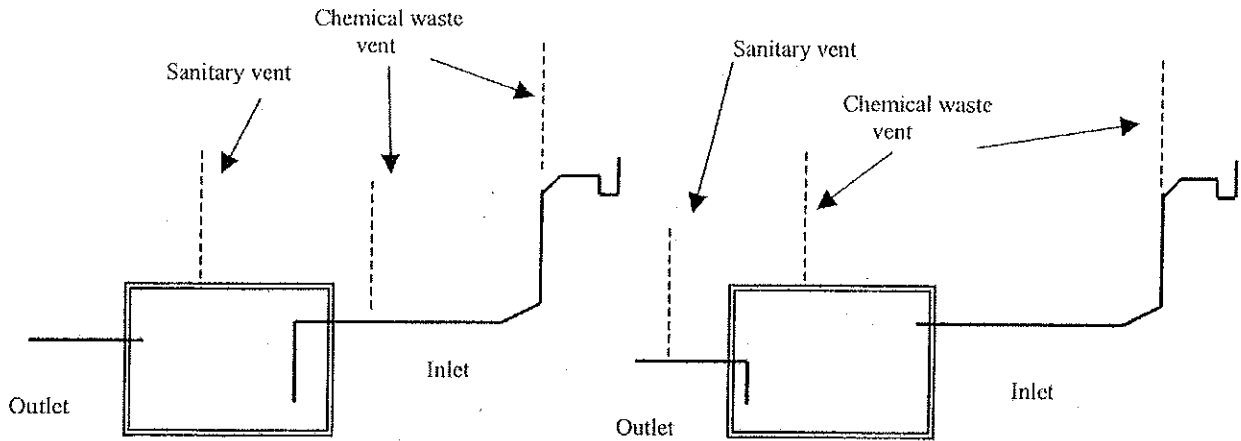

A-82.35 (3) CLEANOUTS SERVING HORIZONTAL DRAINS WITHIN OR UNDER A BUILDING.

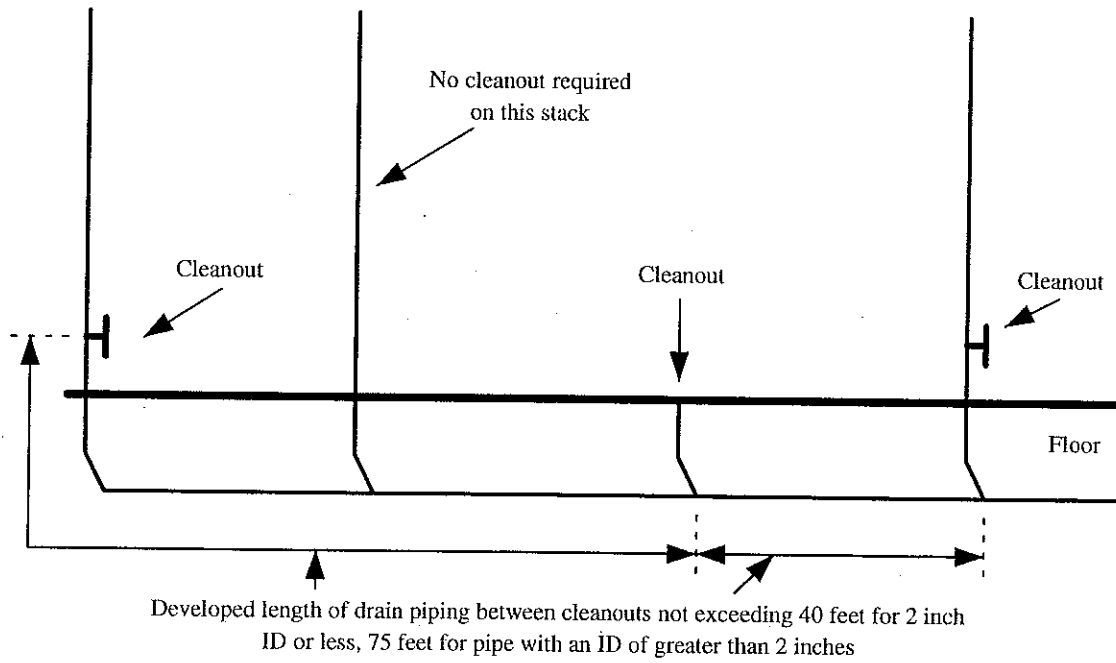

A-82.35 (5) (a) CLEANOUT EXTENSION TO GRADE.

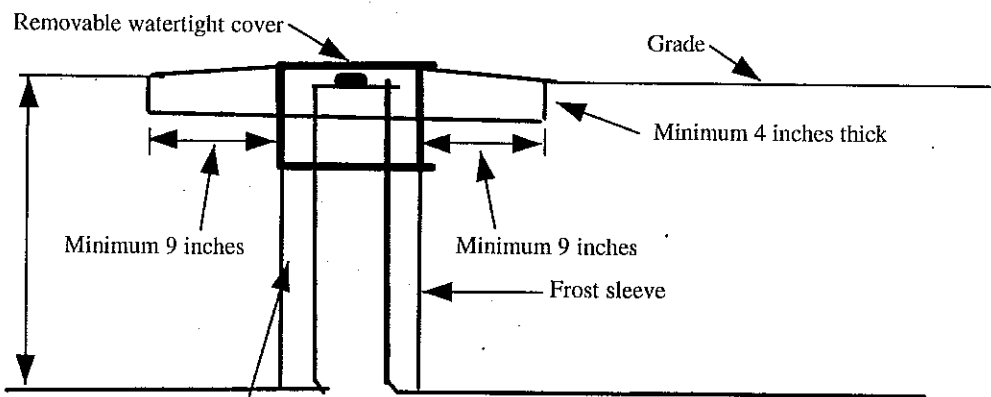
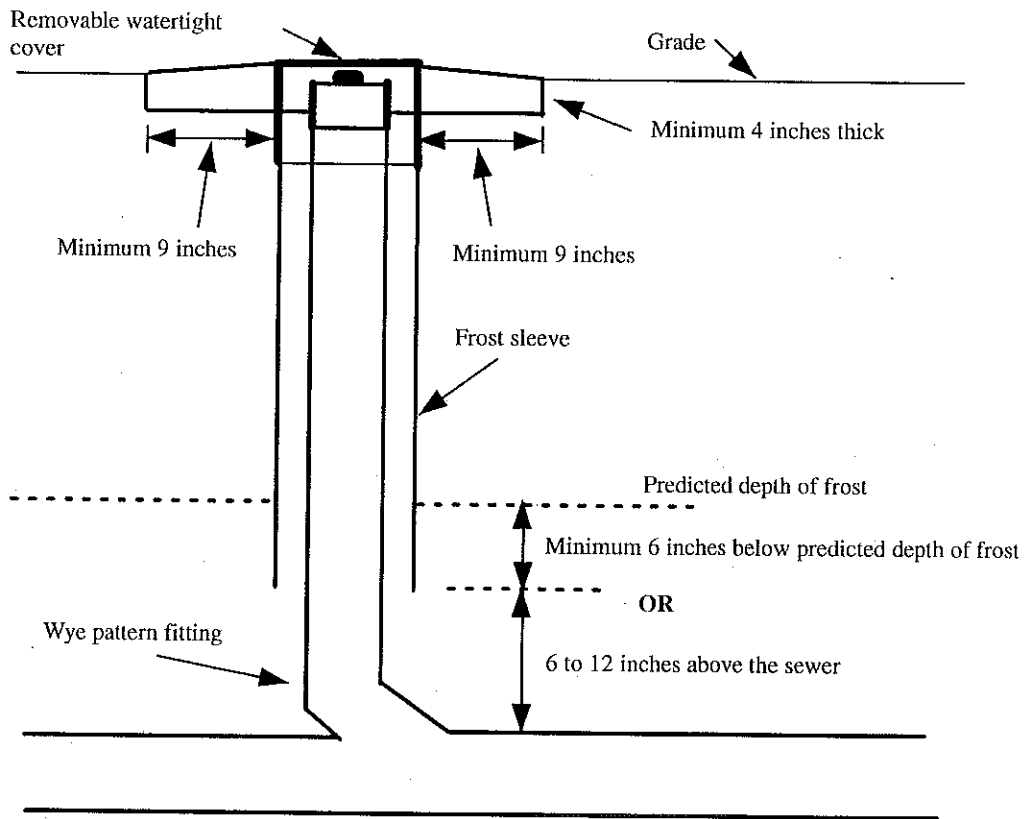

If depth is 18 inches or less, this may be a sanitary pattern fitting

A-82.35 (8) OUTSIDE DROP INTO AN EXISTING MANHOLE.

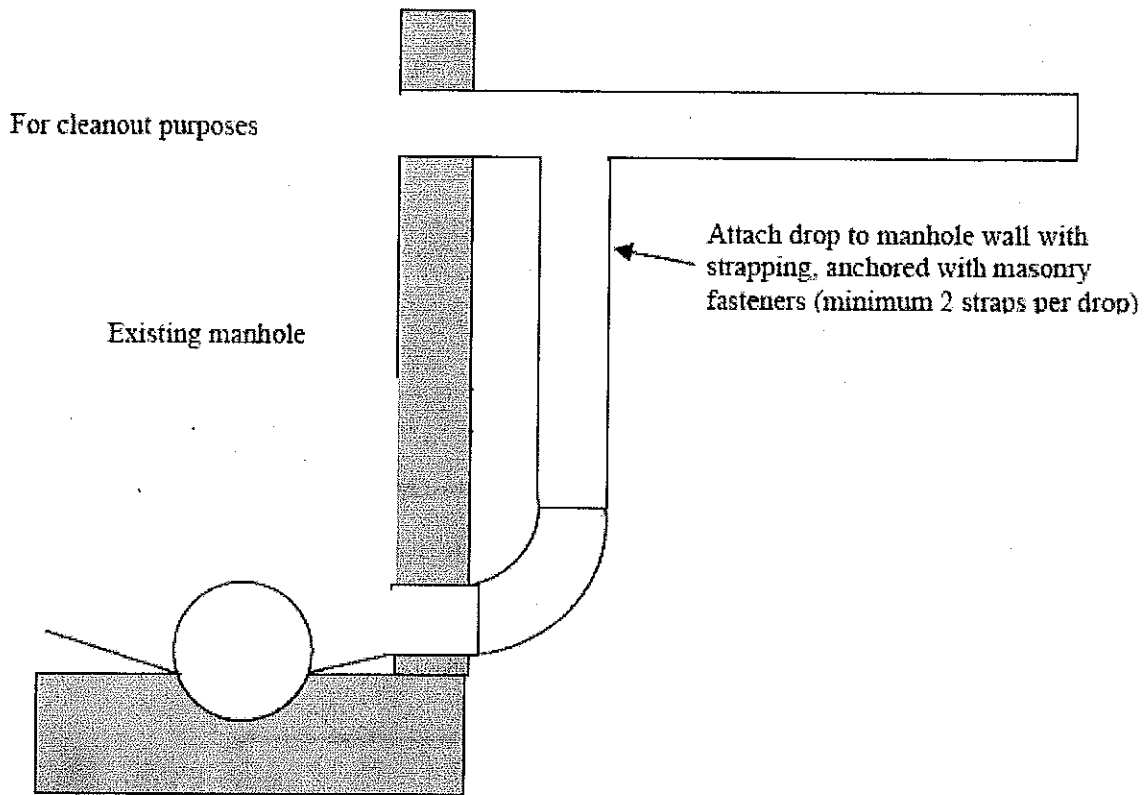

A-82.36 (3) SOURCES OF POLLUTANTS IN WISCONSIN STORMWATER.

SOURCES OF POLLUTANTS IN WISCONSIN STORMWATER

Geometric Mean Concentrations of Contaminants in Runoff from Source-Area and Storm-Sewer Outfalls

Contaminant	Feeder Streets	Collector Streets	Arterial Streets	Lawns	Driveways	Roofs	Parking Lots	Outfall
Residential Source Areas								
Total Solids (mg/L)	796	493	—	600	306	91	—	369
Suspended Solids (mg/L)	662	326	—	397	173	27	—	262
Total Phosphorus (mg/L)	1.31	1/07	—	2.67	1.16	.15	—	.66
Total Recoverable Copper (µg/L)	24	56	—	13	17	15	—	16
Total Recoverable Lead (µg/L)	33	55	—	—	17	21	—	32
Total Recoverable Zinc (µg/L)	220	339	—	59	107	149	—	203
Fecal Coliform (cfu/100mL)	92,061	56,554	—	42,093	34,294	294	0	175,106
Commercial Source Areas								
Total Solids (mg/L)	—	—	373	—	—	112	127	—
Suspended Solids (mg/L)	—	—	232	—	—	15	58	—
Total Phosphorus (mg/L)	—	—	.47	—	—	.20	.19	—
Total Recoverable Copper (µg/L)	—	—	46	—	—	9	15	—
Total Recoverable Lead (µg/L)	—	—	50	—	—	9	22	—
Total Recoverable Zinc (µg/L)	—	—	508	—	—	330	178	—
Fecal Coliform (cfu/100mL)	—	—	9,627	—	—	1,117	1,758	—
Industrial Source Areas								
Total Solids (mg/L)	—	958	879	—	—	78	531	267
Suspended Solids (mg/L)	—	763	690	—	—	41	312	146
Total Phosphorus (mg/L)	—	1.5	.94	—	—	.11	.39	.34
Total Recoverable Copper (µg/L)	—	76	74	—	—	6	41	28
Total Recoverable Lead (µg/L)	—	86	60	—	—	8	38	25
Total Recoverable Zinc (µg/L)	—	479	575	—	—	1,155	304	265
Fecal Coliform (cfu/100mL)	—	8,338	4,587	—	—	144	2,705	5,114

Source: Bannerman, R.T.; Owens D.W.; Dodds, R.B.; and Hornewer, N.J., 1993, Sources of Pollutants in Wisconsin Stormwater: Water Science Technology, v.28, nos. 3-5, pp. 241-259.

Note: Single dash indicates source area is not in the land use; double dash indicates insufficient data; and triple dash indicates values are shared with those above for the same source area. The relatively large concentrations of zinc in roof runoff indicate that galvanized roofing materials were a source of the zinc. One-third of the residential roofs had galvanized downspouts. Roofing materials also might be a source of copper and lead in the runoff from residential roofs. Concentrations of dissolved copper and total recoverable copper and lead were slightly larger in the residential roof runoff than in runoff from driveways and lawns.

Note: The department has accepted that a "visible sheen" is defined as 15 mg/L grease and oil.

A-82.36 (3)-1. BEST MANAGEMENT PRACTICES (BMPs). A description of the proposed best management practices to be used for stormwater management in the protection of water quality include, but are not limited to, the following:

- a. Detention, retention and sedimentation facilities, including plans for discharges from the facilities, maintenance plans and predictions of water quality.
- b. Areas of the site to be used or reserved for infiltration including a prediction of the impact on groundwater quality.
- c. Any other relevant volume controls or measures.
- d. Any other relevant source control practices not described.
- e. Any treatment device, including plans for discharges from the facilities, maintenance plans and predictions of water quality.

Note: Section NR 151.002 (4) reads: "'Best management practices' or 'BMPs' means structural or non-structural measures, practices, techniques or devices employed to avoid or minimize soil, sediment or pollutants carried in runoff to waters of the state."

A-82.36 (4)-1. RATIONAL METHOD. The equation procedure for using the rational method formula is as follows:

$$Q = Aci \text{ (in cubic feet per second)}$$

Where: Q = Runoff (in cubic feet per second)

A = Drainage area (in acres)

c = Coefficient of runoff (a dimensionless number)

i = Intensity of rainfall (in inches per hour)

$$Q = \frac{(0.0104)ciA}{(1/96)} \text{ (in gallons per minute)}$$

Where: Q = Runoff (in gallons per minute)

c = Coefficient of runoff (a dimensionless number)

i = Intensity of rainfall (in inches per hour)

A = Drainage area (in square feet)

A-82.36(4)-2. RUNOFF COEFFICIENTS. Tables Detail A and B are for using the rational formula.

DETAIL A: RUNOFF COEFFICIENTS (C), RATIONAL FORMULA

Land Use	Percent Imper-vious Area	Design Storm 24-Hour Event	Hydrologic Soil Group											
			A			B			C			D		
			Slope Range (%)			Slope Range (%)			Slope Range (%)			Slope Range (%)		
			0-2	2-6	> 6	0-2	2-6	> 6	0-2	2-6	> 6	0-2	2-6	> 6
Industrial	90	2- and 10-year	0.67	0.58	0.68	0.68	0.68	0.69	0.68	0.69	0.69	0.69	0.69	0.70
		25-, 50-, and 100-year	0.85	0.85	0.86	0.85	0.86	0.86	0.86	0.86	0.86	0.87	0.86	0.86
Commercial	95	2- and 10-year	0.71	0.71	0.72	0.71	0.72	0.72	0.72	0.72	0.72	0.72	0.72	0.72
		25-, 50-, and 100-year	0.88	0.89	0.89	0.89	0.89	0.89	0.89	0.89	0.89	0.89	0.89	0.89
Residential: gh-density (>6 units/acre)	60	2- and 10-year	0.47	0.49	0.50	0.48	0.50	0.52	0.49	0.51	0.54	0.51	0.53	0.56
		25-, 50-, and 100-year	0.58	0.60	0.61	0.59	0.61	0.64	0.60	0.62	0.66	0.62	0.66	0.69
Medium-density (2-6 units/acre)	30	2- and 10-year	0.25	0.28	0.31	0.27	0.30	0.35	0.30	0.33	0.38	0.33	0.36	0.42
		25-, 50-, and 100-year	0.33	0.37	0.40	0.35	0.39	0.44	0.38	0.42	0.49	0.41	0.45	0.54
Low-density (0.7-2 units/acre)	15	2- and 10-year	0.14	0.19	0.22	0.17	0.21	0.26	0.20	0.25	0.31	0.24	0.28	0.35
		25-, 50-, and 100-year	0.22	0.26	0.29	0.24	0.28	0.34	0.28	0.32	0.40	0.31	0.35	0.46
Agriculture	5	2- and 10-year	0.08	0.13	0.16	0.11	0.15	0.21	0.14	0.19	0.26	0.18	0.23	0.31
		25-, 50-, and 100-year	0.14	0.18	0.22	0.16	0.21	0.28	0.20	0.25	0.34	0.24	0.29	0.41
Open Space	2	2- and 10-year	0.05	0.10	0.14	0.08	0.13	0.19	0.12	0.17	0.24	0.16	0.21	0.28
		25-, 50-, and 100-year	0.11	0.16	0.20	0.14	0.19	0.26	0.18	0.23	0.32	0.22	0.27	0.39
Freeways and Expressways	70	2- and 10-year	0.57	0.59	0.60	0.58	0.60	0.61	0.59	0.61	0.63	0.60	0.62	0.64
		25-, 50-, and 100-year	0.70	0.71	0.72	0.71	0.72	0.74	0.72	0.72	0.73	0.76	0.75	0.78

Source: Wisconsin department of transportation (WDOT), Facilities Development Manual (July 2, 1979), Procedure 13-10-5.

DETAIL B: RUNOFF COEFFICIENTS (C), FOR SPECIFIC LAND USE

Land Use	Design Storm 24-Hour Event	Hydrologic Soil Group											
		A			B			C			D		
		Slope Range (%)			Slope Range (%)			Slope Range (%)			Slope Range (%)		
		0-2	2-6	> 6	0-2	2-6	> 6	0-2	2-6	> 6	0-2	2-6	> 6
Row Crops	2- and 10-year	0.08	0.16	0.22	0.12	0.20	0.27	0.15	0.24	0.33	0.19	0.28	0.38
	25-, 50-, and 100-year	0.22	0.30	0.38	0.16	0.34	0.44	0.30	0.37	0.50	0.34	0.41	0.56
Median Strip, turf	2- and 10-year	0.19	0.20	0.24	0.19	0.22	0.26	0.20	0.23	0.30	0.20	0.25	0.30
	25-, 50-, and 100-year	0.24	0.26	0.30	0.25	0.28	0.33	0.26	0.30	0.37	0.27	0.32	0.40
Slide Slope, turf	2- and 10-year	---	---	0.25	---	---	0.27	---	---	0.28	---	---	0.30
	25-, 50-, and 100-year	---	---	0.32	---	---	0.34	---	---	0.36	---	---	0.38
Pavement:													
Asphalt	0.70-0.95												
Brick	0.70-0.80												
Concrete	0.80-0.95												
Drives and Walks	0.75-0.85												
Roofs	0.75-0.95												
Gravel Roads Shoulders	0.40-0.60												

Source: Wisconsin department of transportation (WDOT), Facilities Development Manual (July 2, 1979), Procedure 13-10-5.

Note: The lower "C" values in each range should be used with the relatively low intensities associated with 2- to 10-year design recurrence intervals whereas the higher "C" values should be used for intensities associated with the longer 25- to 100-year design recurrence intervals.

Note: In parking lot runoff, visible sheen has been accepted as having an oil concentration of 15 mg/L.

A-82.36 (4)-3. OTHER METHODS OR MODELS. A model that calculates peak flow such as TR-55, P8 or an equivalent methodology may be used.

Information on how to access P8 is available at the department of natural resources webpage: <http://dnr.wi.gov/runoff/models/> or contact the stormwater coordinator in the runoff management section of the bureau of watershed management at the department of natural resources at phone 608-267-7694.

A simplified TR-55 approach, TR-55 (210-vf-TR-55, second edition, June 1986), may be obtained by accessing the USDA NRCS webpage: <http://dnr.wi.gov/runoff/models/>.

A-82.36 (6)-1. THE FORMULA FOR SOLVING FOR DIAMETER, D FOR ROOF CONDUCTORS.

$$D=1.128 \sqrt{\frac{A}{X}}$$

Where, A=the area of the roof in square feet.

X=one of the following:

300 square feet per square inch for a roof covered with gravel or slag and with a pitch not exceeding ¼ inch per foot.

250 square feet per square inch for a roof covered with gravel or slag and with a pitch of greater than ¼ inch per foot.

200 square feet per square inch for a roof with a metal, tile, brick or slate covering and with any pitch.

A-82.36 (8) (a) SAFETY CODE FOR ELEVATORS AND ESCALATORS. Safety code for elevators and escalators as specified in ASME A17.1-2007 reads:

ASSME A17.1-2007 SECTION 2.2, PITS 2.2.2 Design and Construction of Pits

2.2.2.4 Drains and sump pumps, where provided, shall comply with the applicable plumbing code, and they shall be provided with a positive means to prevent water, gases, and odors from entering the hoistway.

2.2.2.5 In elevators provided with Firefighters' Emergency Operation, a drain or sump pump shall be provided. The sump pump/drain shall have the capacity to remove a minimum of 11.4 m³/h (3,000 gal/h) per elevator.

2.2.2.6 Sumps and sump pumps in pits, where provided, shall be covered. The cover shall be secured and level with the pit floor.

A-82.36 (9) (b) AREA DRAIN INLETS.

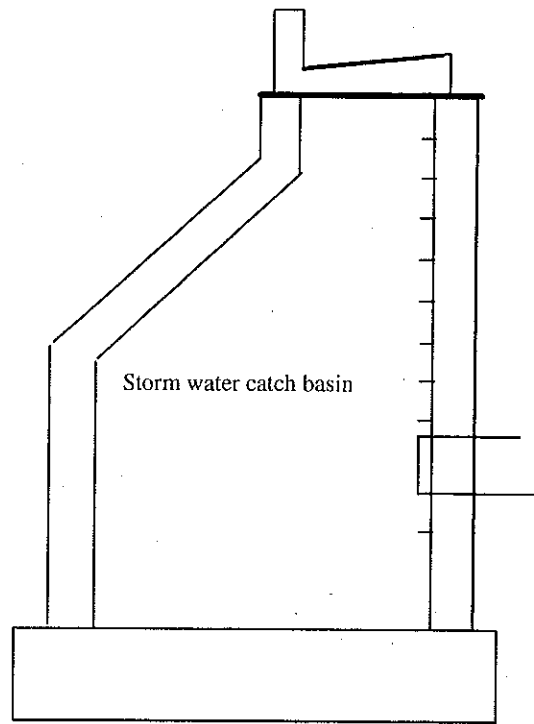
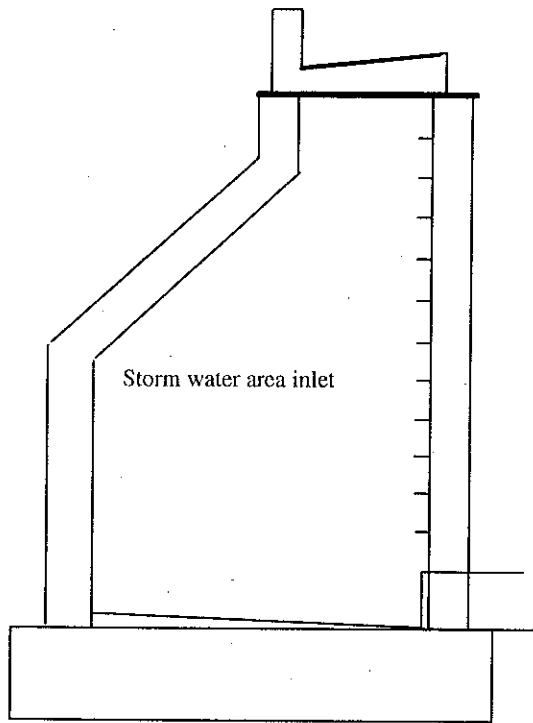

A-82.36(9)(b) 3. INLET GRATES.

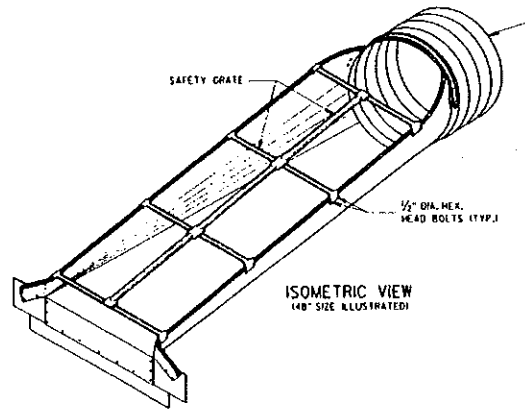

GRATES FOR HORIZONTAL PIPING

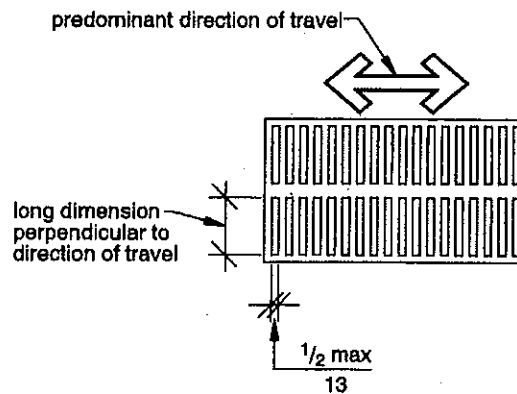

GRATES FOR VERTICAL PIPING

FORMULA TO CALCULATE CAPACITY, IN CUBIC FEET PER SECOND:

$$Q = \frac{2}{3} A C (2gh)^{1/2}$$

Where : Q = the capacity of the inlet, cfs

$\frac{2}{3}$ = a factor to correct for assumed blockage of 1/3 of the inlet's net open area

A = the net open area of the inlet, sq. ft

C = an orifice coefficient, usually taken as 0.60

G = a constant, 32.2 ft/sec/sec

H = the head, in feet on the inlet, or the depth of water on top of the inlet, usually not more than two or three inches.

A-82.365 (1) CLASS V INJECTION WELLS. An injection well is described as being any well, drilled or dug hole, used to inject fluids into the subsoil. A stormwater collection well may be a class V injection well.

Federal regulations (40 CFR 144.26) require that all injection wells be reported to the state underground injection control (UIC) program authority for the purpose of developing a state inventory of injection practices. In Wisconsin, the department of natural resources, bureau of drinking water and groundwater, maintains this inventory and registration program, form 3300-253. For more information, refer to www.dnr.state.wi.us/.

A-82.37 (3) CAMPSITE RECEPTORS AND WATER SUPPLY

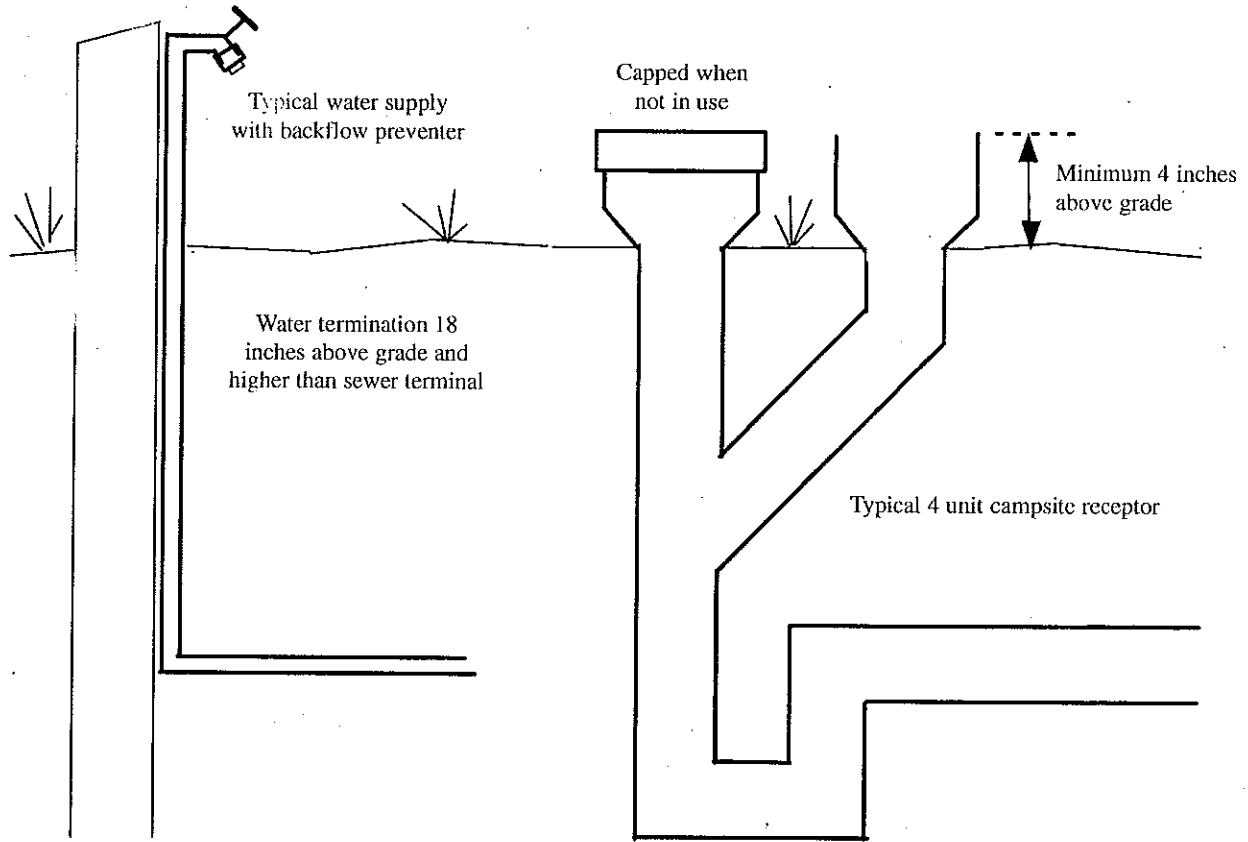

A-82.40 (4) CONTROL VALVES.

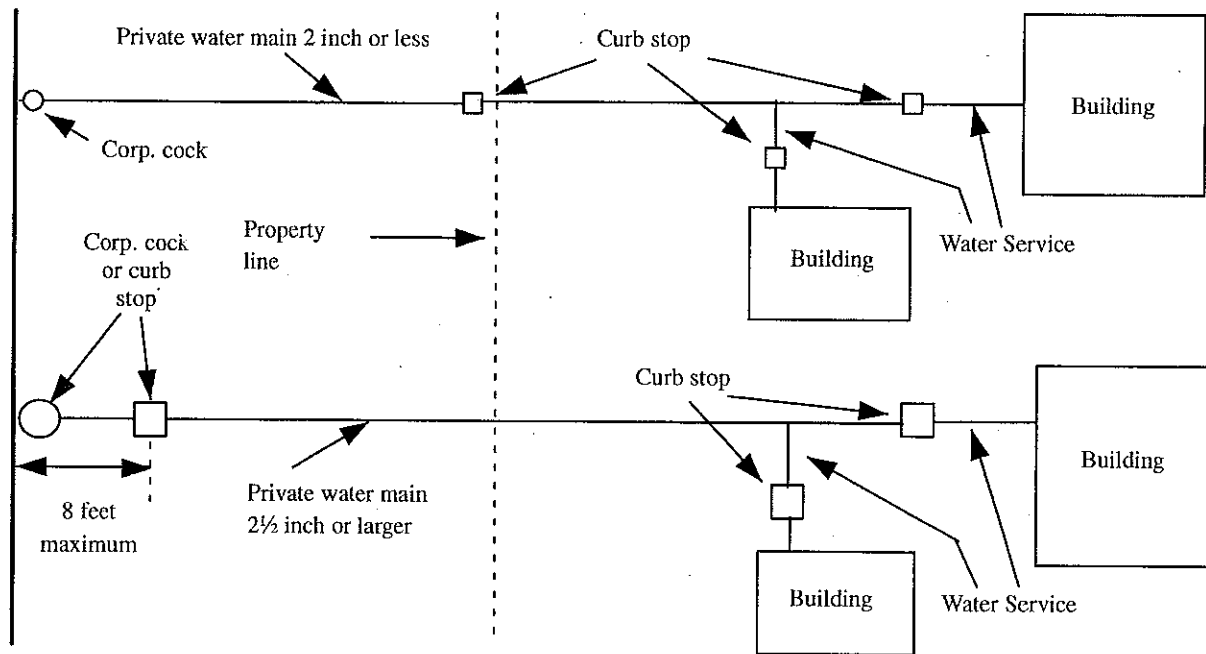

A-82.40 (5) PIPING INSULATION. The following is a reprint of s. Comm 63.1029 (1) and (2) and Table 63.1029.

Comm 63.1029 Insulation, materials and construction. (1) GENERAL. Insulation required by subs. (2) and (3) shall be suitably protected from damage. Insulation shall be installed in accordance with practices acceptable to the department. The department accepts MICA Commercial and Industrial Insulation Standards as an insulation installation practice.

(2) PIPING INSULATION. Except as provided in pars. (a) to (c), recirculating plumbing system piping, plumbing piping in the first 8 feet from storage tanks for noncirculating systems, any piping served by a self-regulating electric heating cable, HVAC system piping, and related HVAC fluid conveying conduit, such as heat exchanger bodies, shall be thermally insulated in accordance with Table 63.1029 or equivalent. The following piping or conduit is exempted from this subsection:

- (a) Factory-installed piping or conduit within HVAC equipment tested and rated in accordance with s. Comm 63.1020.
- (b) Piping or conduit for which no insulation is specified in Table 63.1029.
- (c) Where it can be shown that the heat gain or heat loss to or from piping or conduit without insulation will not increase building energy use.

**Table 63.1029
PLUMBING AND HVAC PIPING MINIMUM INSULATION (R-VALUE)**

Fluid Design Operating Temp. Range, °F	Insulation Conductivity ^a		Nominal Pipe Diameter					
	Conductivity Range Btu-in./- (h-ft ² -°F)	Mean Rating Temp. °F	Runouts ^b up to 2 inches	1 inch and less	1¼ to 2 inches	2½ to 4 inches	5 and 6 inches	8 inches and up
Heating Systems (Steam, Steam Condensate and Hot Water)								
Above 350	0.32-0.34	250	R-4.4	R-4.4	R-7.4	R-8.8	R-10.3	R-10.3
251-350	0.29-0.31	200	R-4.8	R-4.8	R-8.1	R-8.1	R-11.3	R-11.3
201-250	0.27-0.30	150	R-3.3	R-3.3	R-5.0	R-6.7	R-6.7	R-11.7
141-200	0.25-0.29	125	R-1.8	R-1.8	R-5.2	R-5.2	R-5.2	R-5.2
105-140	0.24-0.28	100	R-1.8	R-1.8	R-3.6	R-3.6	R-3.6	R-5.4
Domestic and Service Hot Water Systems^c								
105 and greater	0.24-0.28	100	R-1.8	R-3.6	R-3.6	R-5.4	R-5.4	R-5.4
Cooling Systems (Chilled Water, Brine and Refrigerant)^d								
40-55	0.23-0.27	75	R-1.9	R-1.9	R-2.8	R-3.7	R-3.7	R-3.7
Below 40	0.23-0.27	75	R-3.7	R-3.7	R-5.6	R-5.6	R-5.6	R-5.6

a For insulation outside the state conductivity range, the minimum thickness (T) shall be determined as follows: $T=PR \{(1+t/PR)K/k - 1\}$, where T = minimum insulation thickness for material with conductivity K, in.; PR = actual outside radius of pipe, in.; t = insulation thickness, in.; K = conductivity of alternate material at mean rating temperature indicated for the application fluid temperature; and k = the lower value of the conductivity range listed for the applicable fluid temperature.

b Runouts to individual terminal units not exceeding 12 ft. in length.

c Applies to recirculating sections of service or domestic hot water systems and first 8 ft. from storage tank for nonrecirculating systems.

d The required minimum thickness does not consider water vapor transmission and condensation.

Maximum Allowable Load For PVC Sched. 80, ASTM 1785, (½ to 2 inches)

Press. Loss due to friction A-value	¼ inch			½ inch			1 inch			1½ inches			2 inches		
	GPM	Vel. Ft/sec	WSFU	GPM	Vel. Ft/sec	WSFU	GPM	Vel. Ft/sec	WSFU	GPM	Vel. Ft/sec	WSFU	CFM	Vel. Ft/sec	WSFU
0.5	0.77	1	—	1.5	1.2	—	3.5	1.5	—	7	1.7	—	9	—	—
1	1.1	1.5	—	2.5	1.8	—	5	2.2	—	10.5	2.6	4	14	5	23
2	1.6	2.2	—	3.7	2.7	—	7.1	3.1	—	15.5	3.8	5	21	7	39
3	2	2.7	—	4.6	3.4	—	9	4	—	19	4.7	6	29	12	55
4	2.4	3.2	—	5.3	3.9	—	10.5	4.6	4	22.3	5.5	7	31	18	60
5	2.7	3.6	—	6	4.4	—	11.8	5.2	4	25.3	6.3	8	40	25	80
6	2.9	3.9	—	6.6	4.9	—	13	5.7	4	27.7	6.9	10	49	32	100
7	3.2	4.3	—	7.2	5.3	—	14.1	6.2	4	30.1	7.5	12	55	39	112
8	3.4	4.6	—	7.7	5.7	—	15	6.6	5	32.3	8	16	60	46	87
9	3.7	5	—	8.2	6	—	16	7.1	5	—	—	—	—	—	—
10	3.9	5.3	—	8.7	6.4	—	17	7.6	5	—	—	—	—	—	—
11	4.1	5.6	—	9.2	6.8	—	17.8	8	5	—	—	—	—	—	—
12	4.3	5.8	—	9.6	7.1	—	—	—	—	—	—	—	—	—	—
13	4.5	6.1	—	10.1	7.5	4	—	—	—	—	—	—	—	—	—
14	4.7	6.4	—	10.5	7.8	4	—	—	—	—	—	—	—	—	—
15	4.8	6.5	—	10.8	8	4	—	—	—	—	—	—	—	—	—
16	5	6.8	—	—	—	—	—	—	—	—	—	—	—	—	—
17	5.2	7.1	—	—	—	—	—	—	—	—	—	—	—	—	—
18	5.3	7.2	—	—	—	—	—	—	—	—	—	—	—	—	—
19	5.5	7.5	—	—	—	—	—	—	—	—	—	—	—	—	—
20	5.7	7.8	—	—	—	—	—	—	—	—	—	—	—	—	—
21	5.8	7.9	—	—	—	—	—	—	—	—	—	—	—	—	—
22	5.9	8	—	—	—	—	—	—	—	—	—	—	—	—	—
Per 100 feet of length															

Note: Approved for cold, tempered, and hot water not exceeding 140° Fahrenheit.

Maximum Allowable Load for Schedule 80 CPVC ASTM F 441 Corzan Pipe (1/2 to 2 inches)

Press. Loss due to Friction A-Value	1/2 inch						3/4 inch						1 inch						1 1/4 inch						1 1/2 inches						2 inches					
	Vel. ft/sec			WSFU			Vel. ft/sec			WSFU			Vel. ft/sec			WSFU			Vel. ft/sec			WSFU			Vel. ft/sec			WSFU			Vel. ft/sec			WSFU		
	GPM	FM	FT	FM	FT	FT	GPM	FM	FT	FM	FT	FT	GPM	FM	FT	FM	FT	FT	GPM	FM	FT	FM	FT	FT	GPM	FM	FT	FM	FT	FT	GPM	FM	FT	FM	FT	FT
0.5	0.36	0.8	—	0.25	0.5	0.7	—	0.5	—	—	—	0.6	1.1	—	0.5	3.2	1.5	—	3	—	—	—	6.9	1.8	—	8	10.5	2	4	14	20.7	2.3	6	31		
1	0.5	1.2	—	0.5	1	1.5	—	1	—	—	—	2.4	1.8	—	2	4.7	2.1	—	4.5	—	—	—	10	2.6	4	13	15.2	2.9	5	22	30.1	3.4	13	55		
2	0.75	1.8	—	0.5	1.5	2.2	—	1.5	—	—	—	3.5	2.7	—	2.5	6.7	3.1	—	8	—	—	—	14.5	3.8	4	20	22.2	4.2	7	35	43.8	4.9	36	106		
3	0.97	2.3	—	1	1.7	2.4	—	1.5	—	—	—	4.3	3.3	—	4	8.3	3.8	—	10	—	—	—	18.1	4.7	6	26	27.6	5.2	10	49	54.5	6.1	60	147		
4	1.1	2.7	—	1	1.8	2.6	—	1.5	—	—	—	5	3.9	—	6	9.7	4.5	—	12	—	—	—	21.1	5.5	7	32	32.2	6	16	60	63.7	7.1	85	193		
5	1.24	3	—	1	2.5	3.6	—	2.5	—	—	—	5.7	4.4	—	6.5	11	5.1	4	15	—	—	—	23.8	6.2	7	39	36.4	6.8	22	74	71.8	8	115	234		
6	1.37	3.3	—	1	2.7	3.9	—	2.5	—	—	—	6.2	4.8	—	7	12.1	5.6	4	16	—	—	—	26.3	6.8	9	45	40.1	7.5	30	87	—	—	—	—		
7	1.5	3.7	—	1.5	2.95	4.3	—	3	—	—	—	6.7	5.2	—	8	13.1	6.1	4	18	—	—	—	28.5	7.4	11	51	42.7	8	34	102	—	—	—	—		
8	1.6	3.9	—	1.5	3.2	4.6	—	3	—	—	—	7.25	5.6	—	9	14.1	6.5	4.5	20	—	—	—	30.8	8	14	56	—	—	—	—	—	—	—	—		
9	1.7	4.1	—	1.5	3.4	4.9	—	3	—	—	—	7.75	6	—	9	15	7	5	21	—	—	—	—	—	—	—	—	—	—	—	—	—	—	—	—	
10	1.8	4.4	—	1.5	3.6	5.2	—	3.5	—	—	—	8.3	6.4	—	10	15.9	7.4	5	23	—	—	—	—	—	—	—	—	—	—	—	—	—	—	—	—	
11	1.9	4.6	—	1.5	3.7	5.4	—	3.5	—	—	—	8.7	6.7	—	11	16.8	7.8	5	24	—	—	—	—	—	—	—	—	—	—	—	—	—	—	—	—	
12	2	4.9	—	2	3.9	5.7	—	3.5	—	—	—	9	7	—	12	17.2	8	5	25	—	—	—	—	—	—	—	—	—	—	—	—	—	—	—	—	—
13	2.08	5.1	—	2	4.1	6	—	4	—	—	—	9.4	7.3	—	12	—	—	—	—	—	—	—	—	—	—	—	—	—	—	—	—	—	—	—	—	—
14	2.16	5.3	—	2	4.3	6.3	—	4	—	—	—	9.8	7.6	4	13	—	—	—	—	—	—	—	—	—	—	—	—	—	—	—	—	—	—	—	—	—
15	2.24	5.5	—	2	4.4	6.4	—	4	—	—	—	10.2	8	4	13	—	—	—	—	—	—	—	—	—	—	—	—	—	—	—	—	—	—	—	—	—
16	2.32	5.7	—	2	4.6	6.7	—	5	—	—	—	—	—	—	—	—	—	—	—	—	—	—	—	—	—	—	—	—	—	—	—	—	—	—	—	—
17	2.4	5.9	—	2	4.8	7	—	5	—	—	—	—	—	—	—	—	—	—	—	—	—	—	—	—	—	—	—	—	—	—	—	—	—	—	—	—
18	2.47	6	—	2	5	7.3	—	6	—	—	—	—	—	—	—	—	—	—	—	—	—	—	—	—	—	—	—	—	—	—	—	—	—	—	—	—
19	2.55	6.2	—	2.5	5.1	7.4	—	6	—	—	—	—	—	—	—	—	—	—	—	—	—	—	—	—	—	—	—	—	—	—	—	—	—	—	—	—
20	2.63	6.4	—	2.5	5.2	7.6	—	6	—	—	—	—	—	—	—	—	—	—	—	—	—	—	—	—	—	—	—	—	—	—	—	—	—	—	—	—
21	2.71	6.6	—	2.5	5.3	7.7	—	6	—	—	—	—	—	—	—	—	—	—	—	—	—	—	—	—	—	—	—	—	—	—	—	—	—	—	—	—
22	2.78	6.8	—	2.5	5.5	8	—	6.5	—	—	—	—	—	—	—	—	—	—	—	—	—	—	—	—	—	—	—	—	—	—	—	—	—	—	—	—
25	3	7.3	—	3	—	—	—	—	—	—	—	—	—	—	—	—	—	—	—	—	—	—	—	—	—	—	—	—	—	—	—	—	—	—	—	—
30	3.25	8	—	3	—	—	—	—	—	—	—	—	—	—	—	—	—	—	—	—	—	—	—	—	—	—	—	—	—	—	—	—	—	—	—	—

Maximum Allowable Load For PVC Sched. 80, ASTM 1785, (2½ to 6 inches)

Press. Loss due to friction A-value	2½ inches						3 inches						3½ inches						4 inches						5 inches						6 inches							
	Vel. ft/sec			WSFU			GPM	Vel. ft/sec	WSFU		Vel. ft/sec			GPM	Vel. ft/sec	WSFU		Vel. ft/sec			GPM	Vel. ft/sec	WSFU		Vel. ft/sec			GPM	Vel. ft/sec	WSFU		Vel. ft/sec			GPM	Vel. ft/sec	WSFU	
	CPM	FM	FI	FM	FI	CPM			FM	FI	CPM	FM	FI			CPM	FM	FI	CPM	FM			FI	CPM	FM	FI	CPM			FM	FI	CPM	FM	FI			CPM	FM
0.5	35	26	20	70		64	3.1	87	195	92	3.3	200	335	130	3.6	425	227	237	4	1,226	1,226	380	4.6	2,546	2,546	569	7	4,647	4,647	380	4.6	2,546	2,546					
1	51	33	30	130		91	4.4	196	330	134	4.8	450	530	188	5.2	835	835	344	6	2,213	2,213	569	7	4,647	4,647	569	7	4,647	4,647	569	7	4,647	4,647					
2	74	56	25	245		132	6.4	436	536	195	7	885	900	274	7.6	1,564	1,564	274	7.6	1,564	1,564	274	7.6	1,564	1,564	274	7.6	1,564	1,564	274	7.6	1,564	1,564					
3	92	69	200	330		164	8	654	717																													
4	108	8	288	415																																		

Per 100 feet of length

Note: Approved for cold, tempered, and hot water not exceeding 140° Fahrenheit.

A-82.40 (7) (a) METHODOLOGY.

Where equipment such as an instantaneous or tankless water heater, water treatment device, water meter, and backflow preventer is provided in the design, the friction loss in such equipment, corresponding to the GPM demand, should be determined from the manufacturer or other reliable source.

Where a direct fired pressurized tank type water heater is provided in the design, the friction loss for such equipment can be assumed as part of the pressure losses due to flow through piping, fittings, valves and other plumbing appurtenances when the developed length of piping is multiplied by 1.5.

The pressure losses due to flow friction through displacement type cold-water meters may be calculated from Graph A-82.40 (7)-1.

Graph A-82.40 (7)-1
PRESSURE LOSS IN COLD-WATER METERS, DISPLACEMENT TYPE
 MAXIMUM CAPACITY AND PRESSURE LOSS
 AS PER AWWA 6700-64

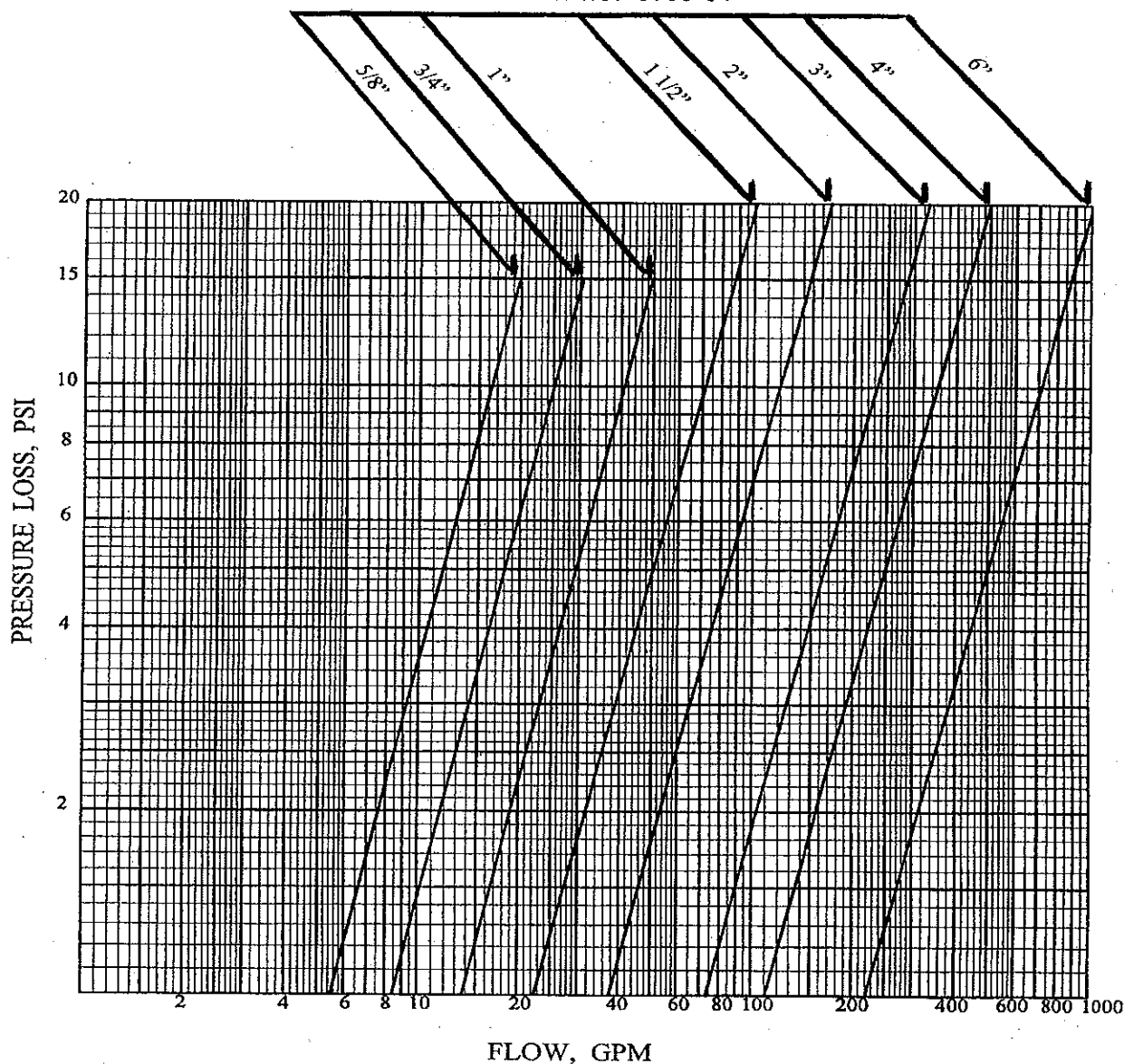

Graph A-82.40 (7)-2
PRESSURE LOSSES DUE TO FLOW FRICTION
Material: Copper Tube-Type K, ASTM B88; (C = 150)

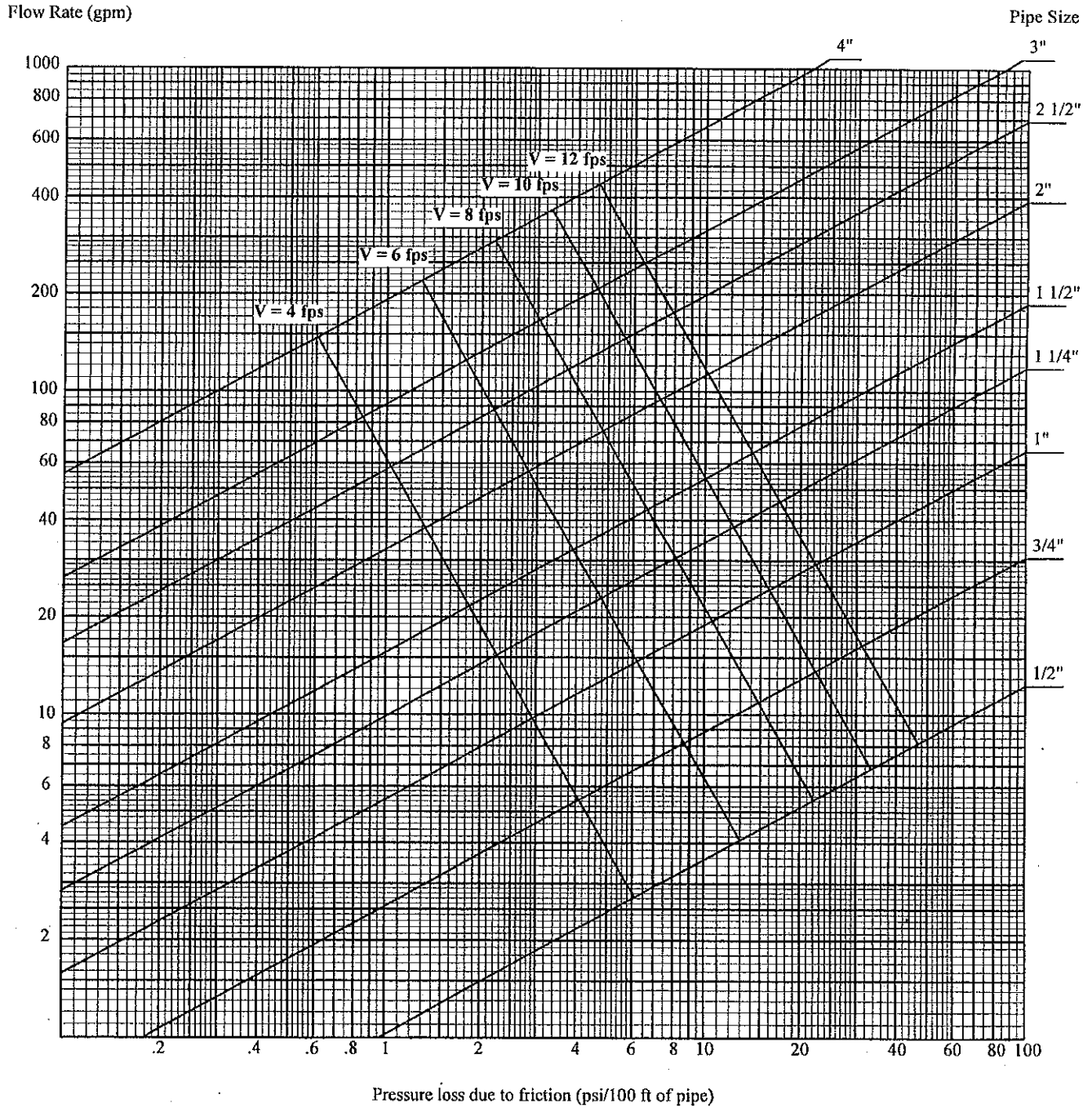

Graph A-82.40 (7)-3
PRESSURE LOSSES DUE TO FLOW FRICTION
Material: Copper Tube-Type L, ASTM B88; (C = 150)

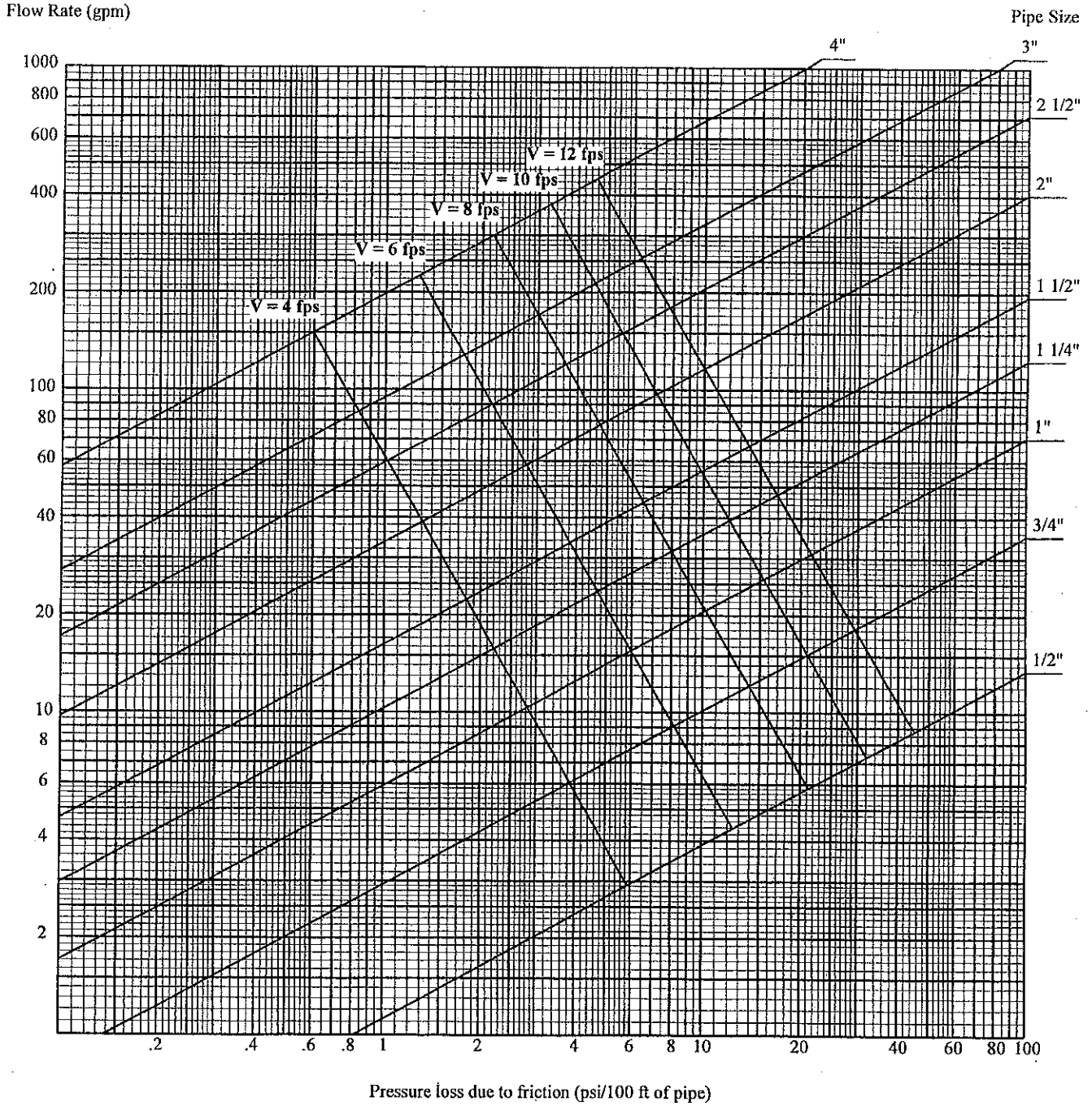

Graph A-82.40 (7)-4

PRESSURE LOSSES DUE TO FLOW FRICTION

Material: Galvanized Steel Pipe-Schedule 40, ASTM A53, ASTM A120; (C = 125)

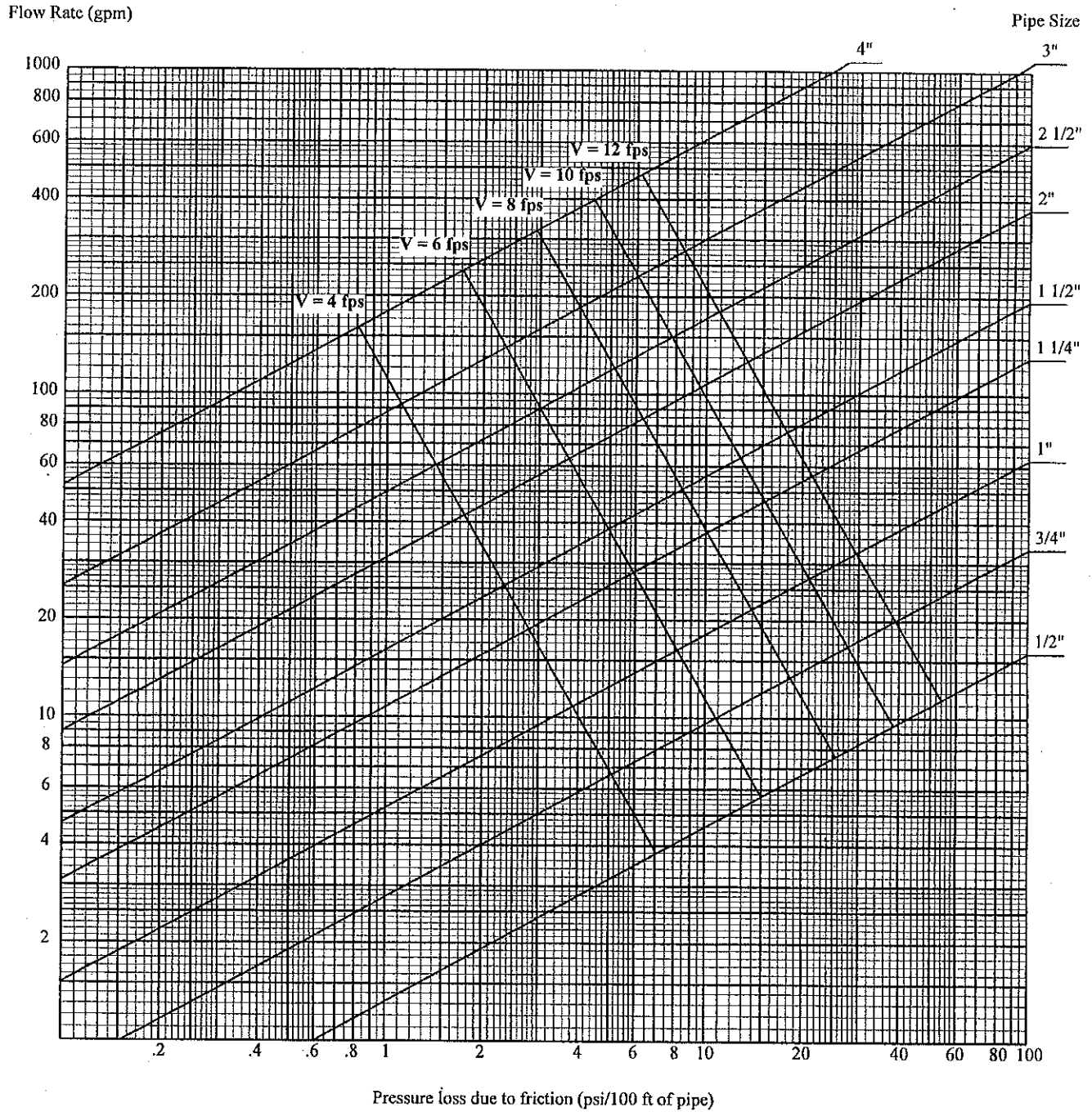

Graph A-82.40 (7)-5

PRESSURE LOSSES DUE TO FLOW FRICTION

Material: Polybutylene Tubing, ASTM D3309; or CPVC Tubing, ASTM D2846; (C = 150)

Flow Rate (gpm)

Pipe Size

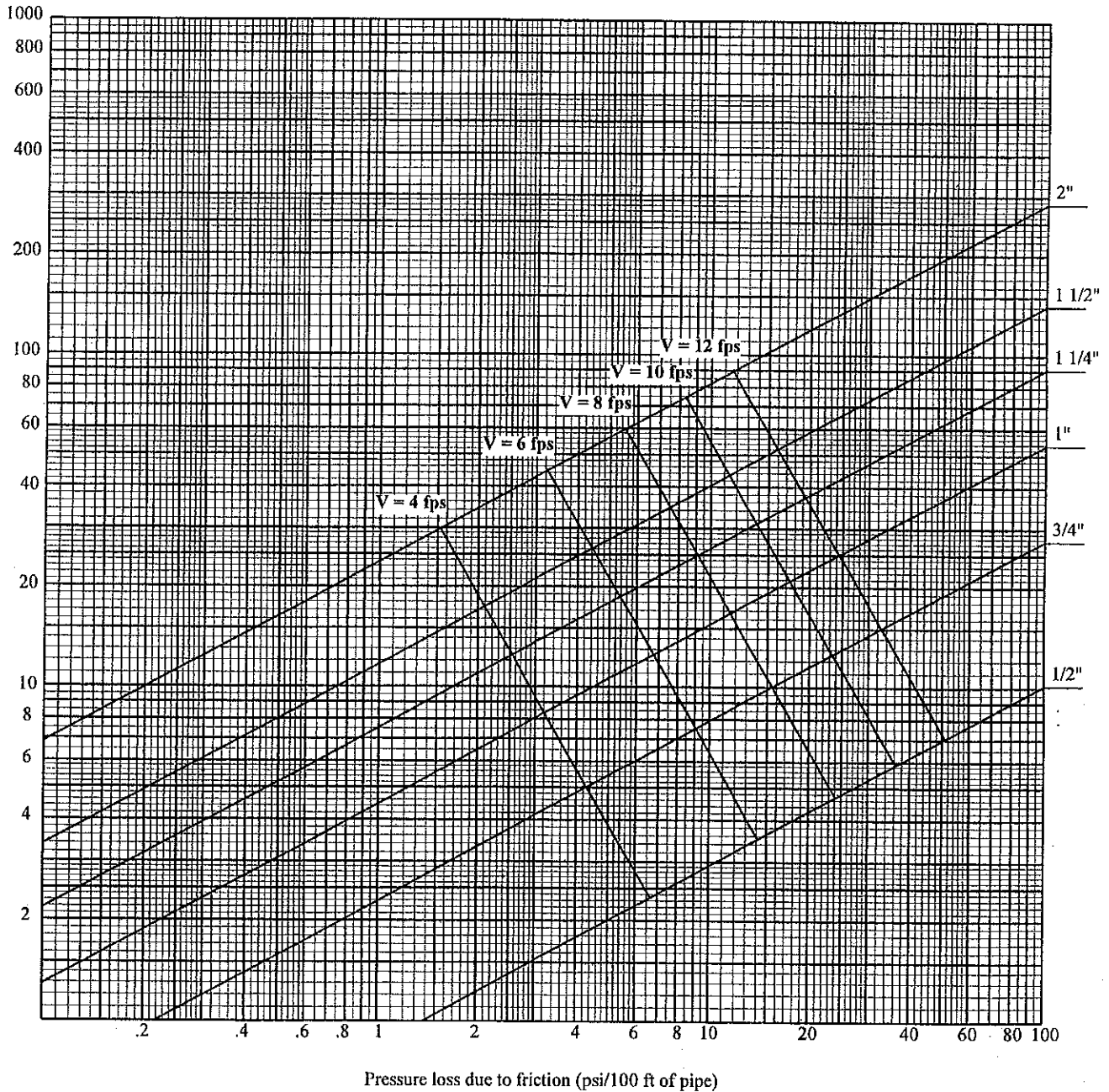

Graph A-82.40 (7)-6
PRESSURE LOSSES DUE TO FLOW FRICTION
Material: Crosslinked Polyethylene (PEX) Tubing, ASTM F876; (C = 150)

Flow Rate (gpm)

Pipe Size

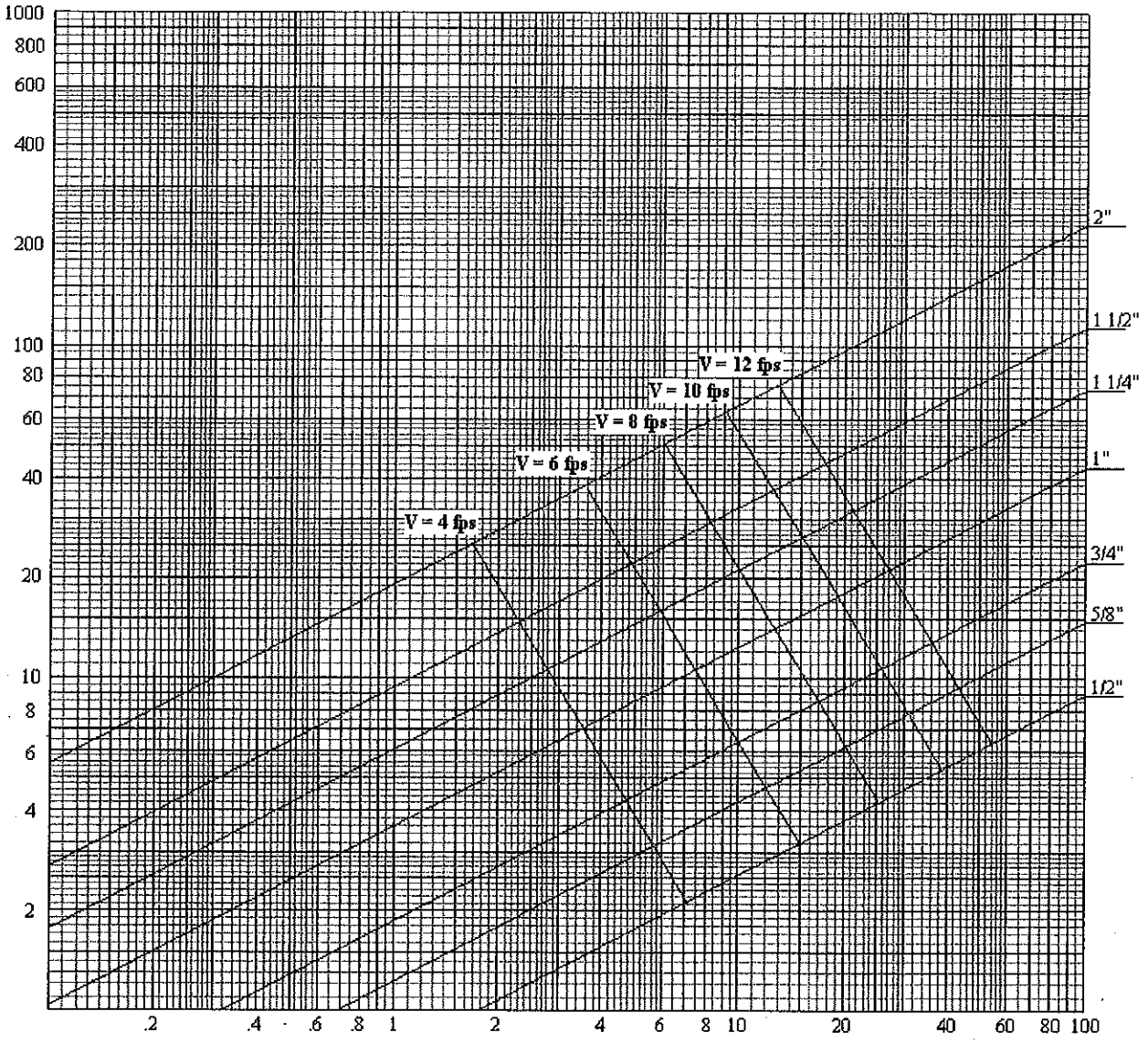

Pressure loss due to friction (psi/100 ft of pipe)

Graph A-82.40 (7)-7
PRESSURE LOSSES DUE TO FLOW FRICTION
Material: Polyethylene Tubing, Copper Tube Size, ASTM D2737; (C = 150)

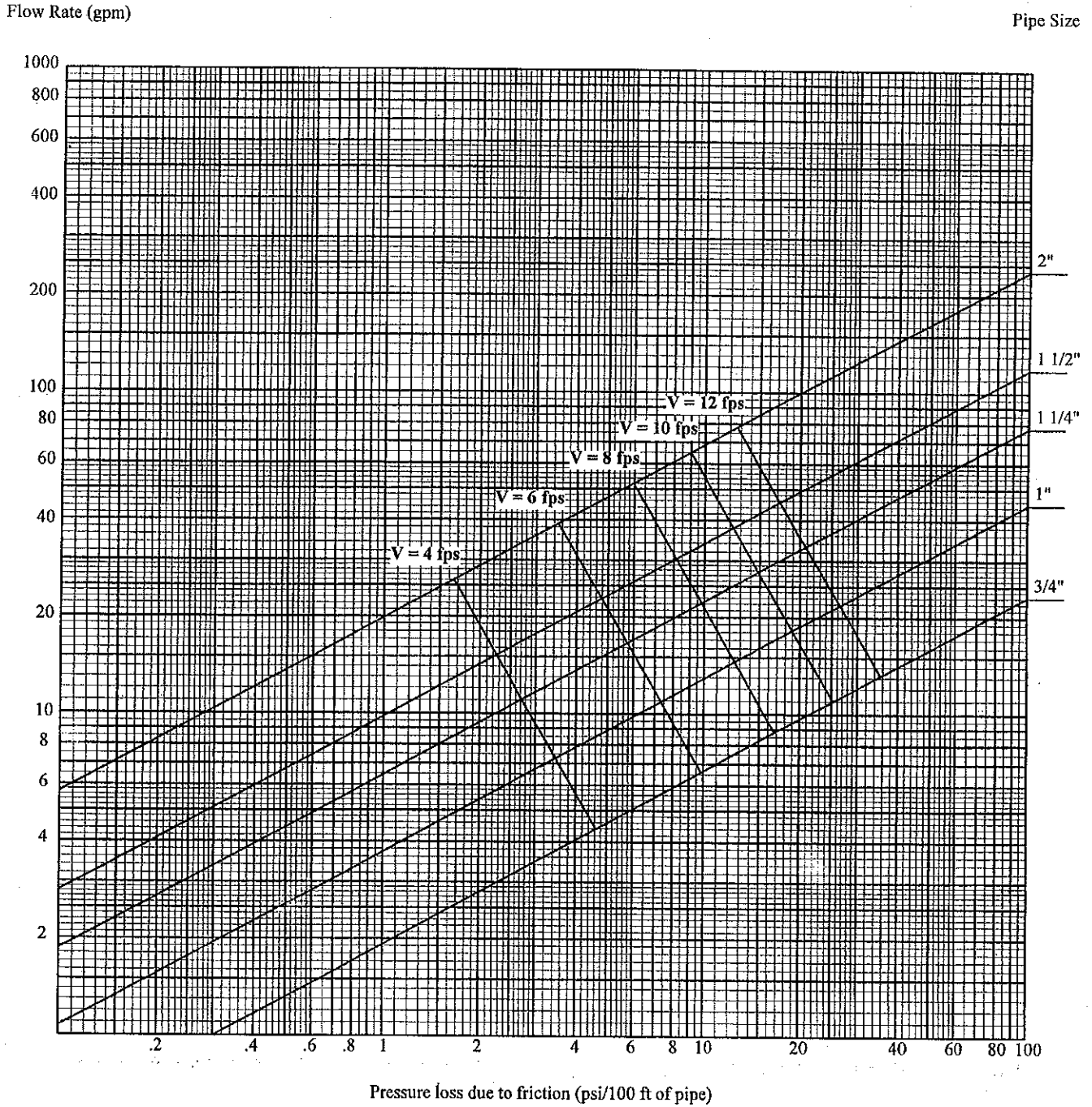

Graph A-82.40 (7)-8

PRESSURE LOSSES DUE TO FLOW FRICTION

Material: ABS Pipe-Schedule 40; ASTM D1527; or
CPVC Pipe-Schedule 40; ASTM F441; or
PE Pipe-Schedule 40; ASTM D2104; ASTM D2447; or
PVC Pipe-Schedule 40; ASTM D1785; ASTM D2672; (C =150)

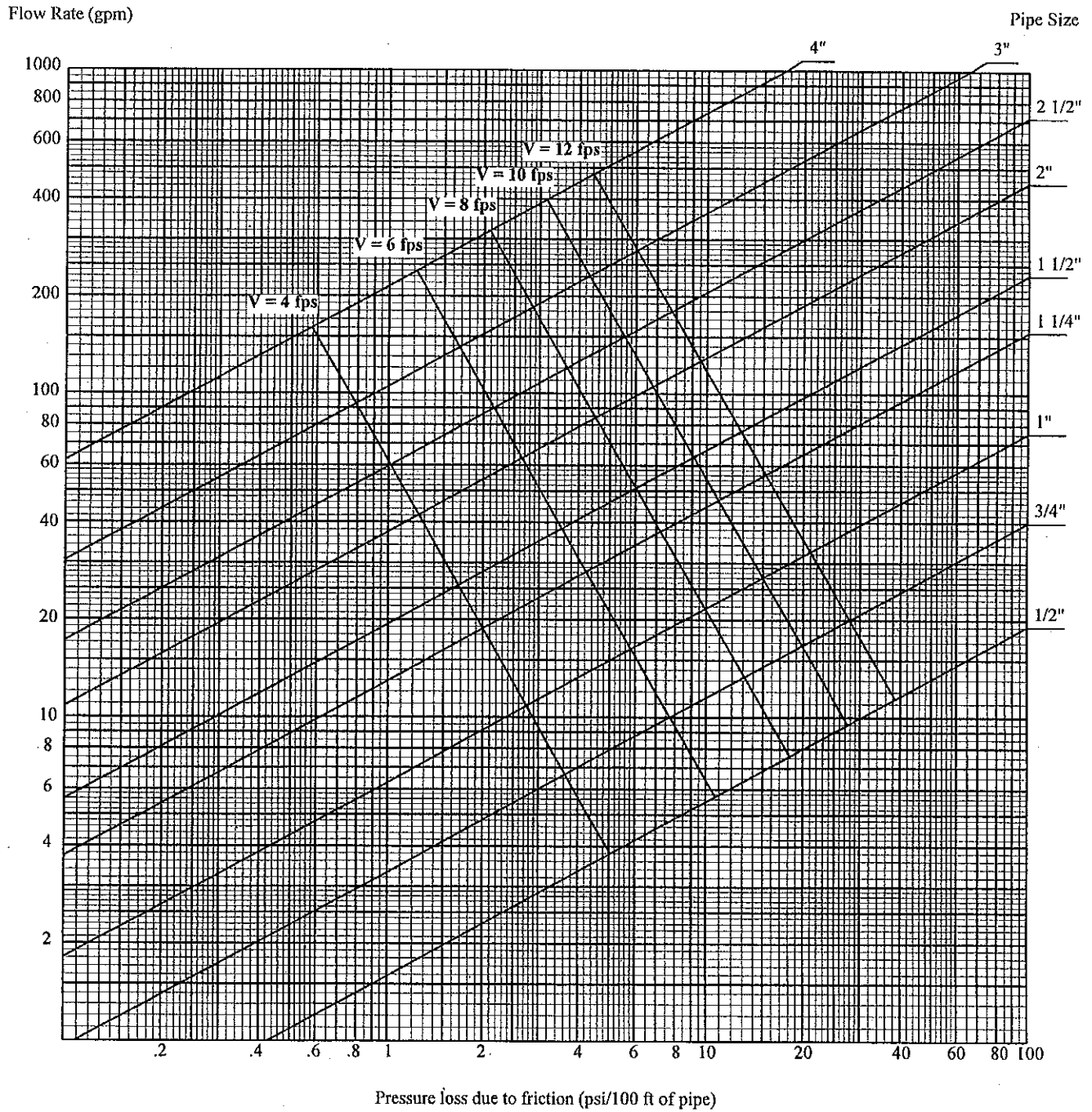

Graph A-82.40 (7)-9
PRESSURE LOSSES DUE TO FLOW FRICTION
Material: Copper Tube-Type M, ASTM B88; (C = 150)

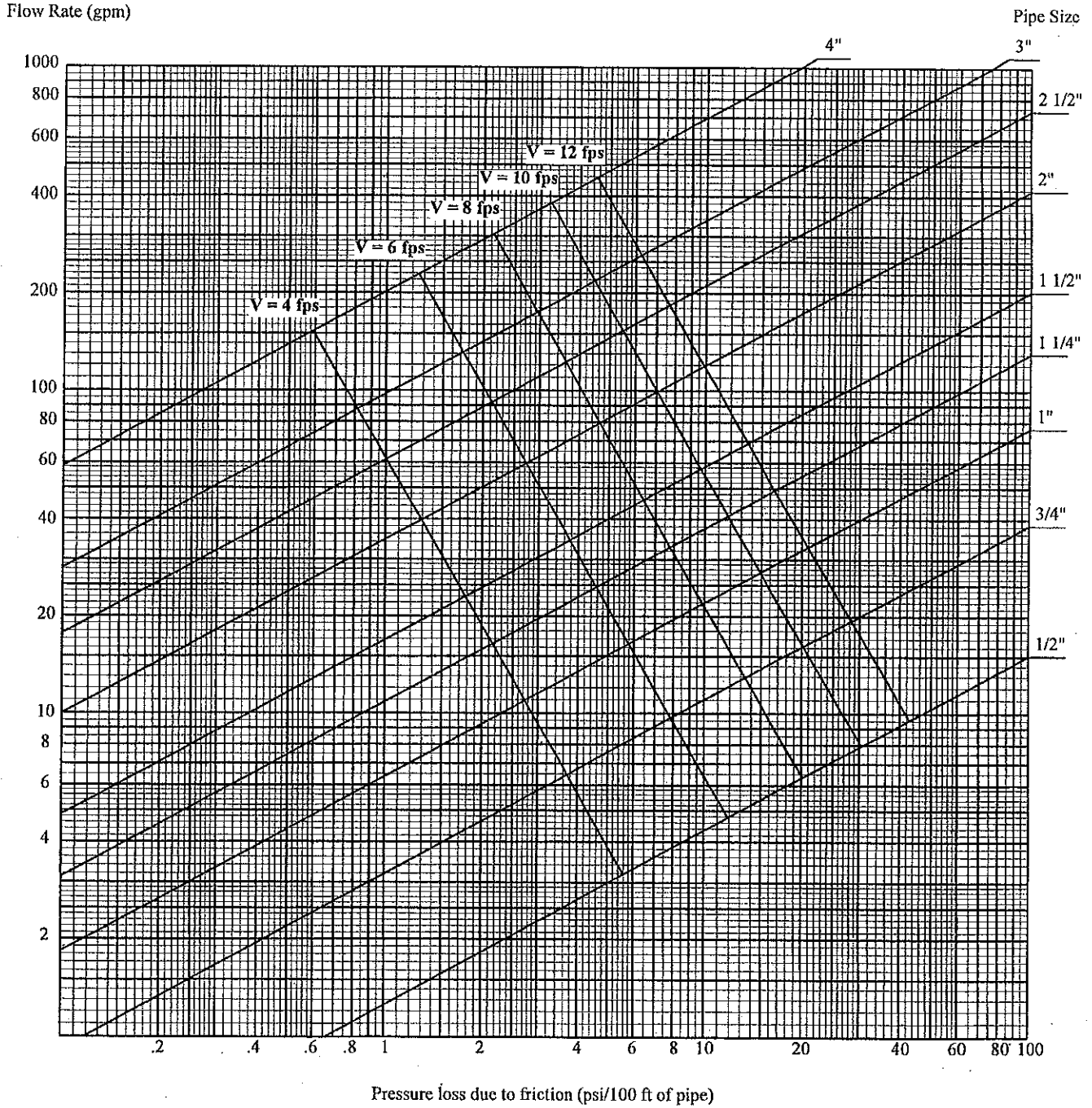

Graph A-82.40 (7)-10

PRESSURE LOSSES DUE TO FLOW FRICTION

Material: Polyethylene Aluminum Polyethylene Tubing (PexAlPex), ASTM F1281; (C = 150)

Flow Rate (gpm)

Pipe Size

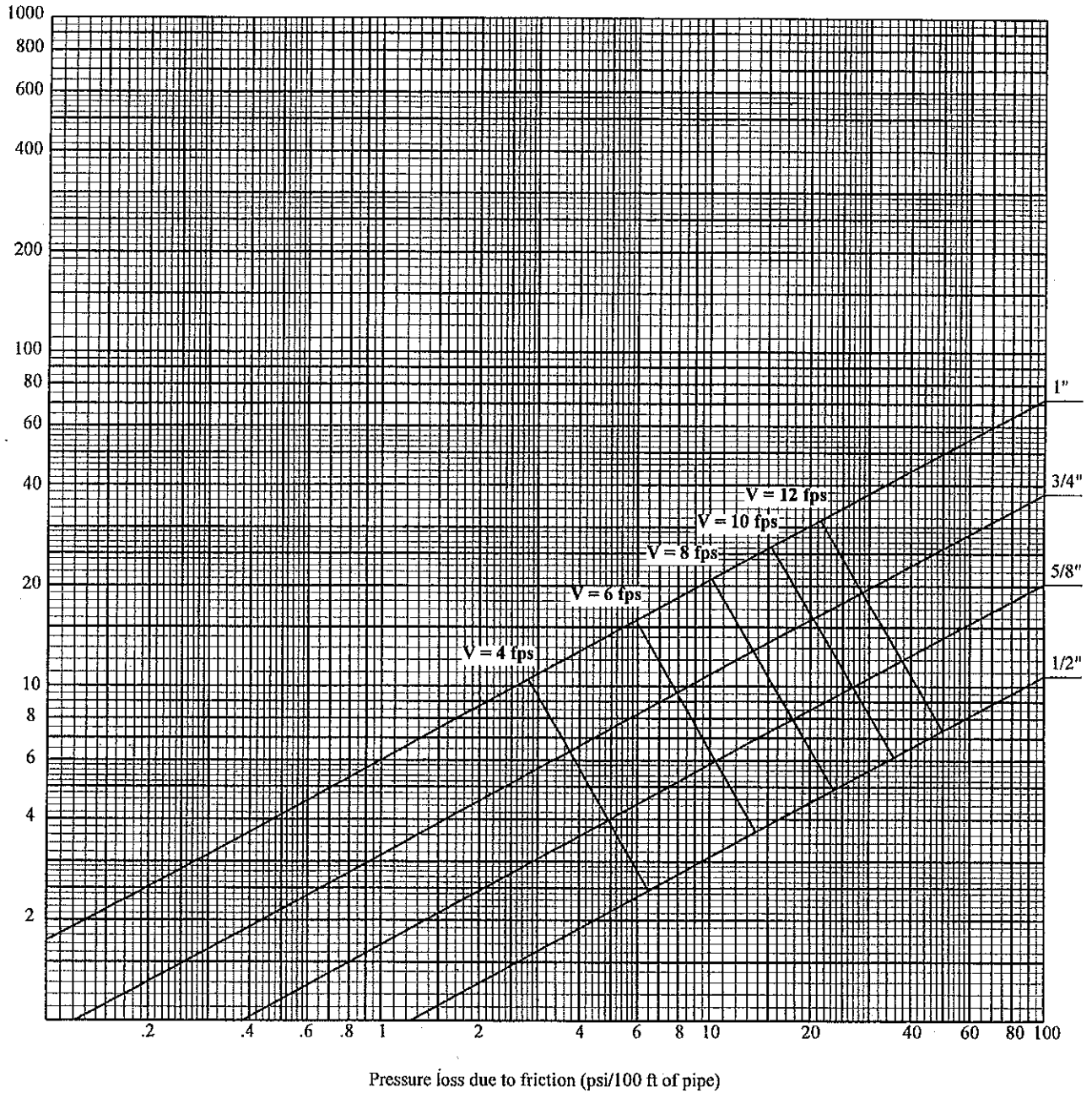

Graph A-82.40 (7)-11
PRESSURE LOSSES DUE TO FLOW FRICTION
Material: CPVC Tubing, SDR 13.5; ASTM F442; (C = 150)

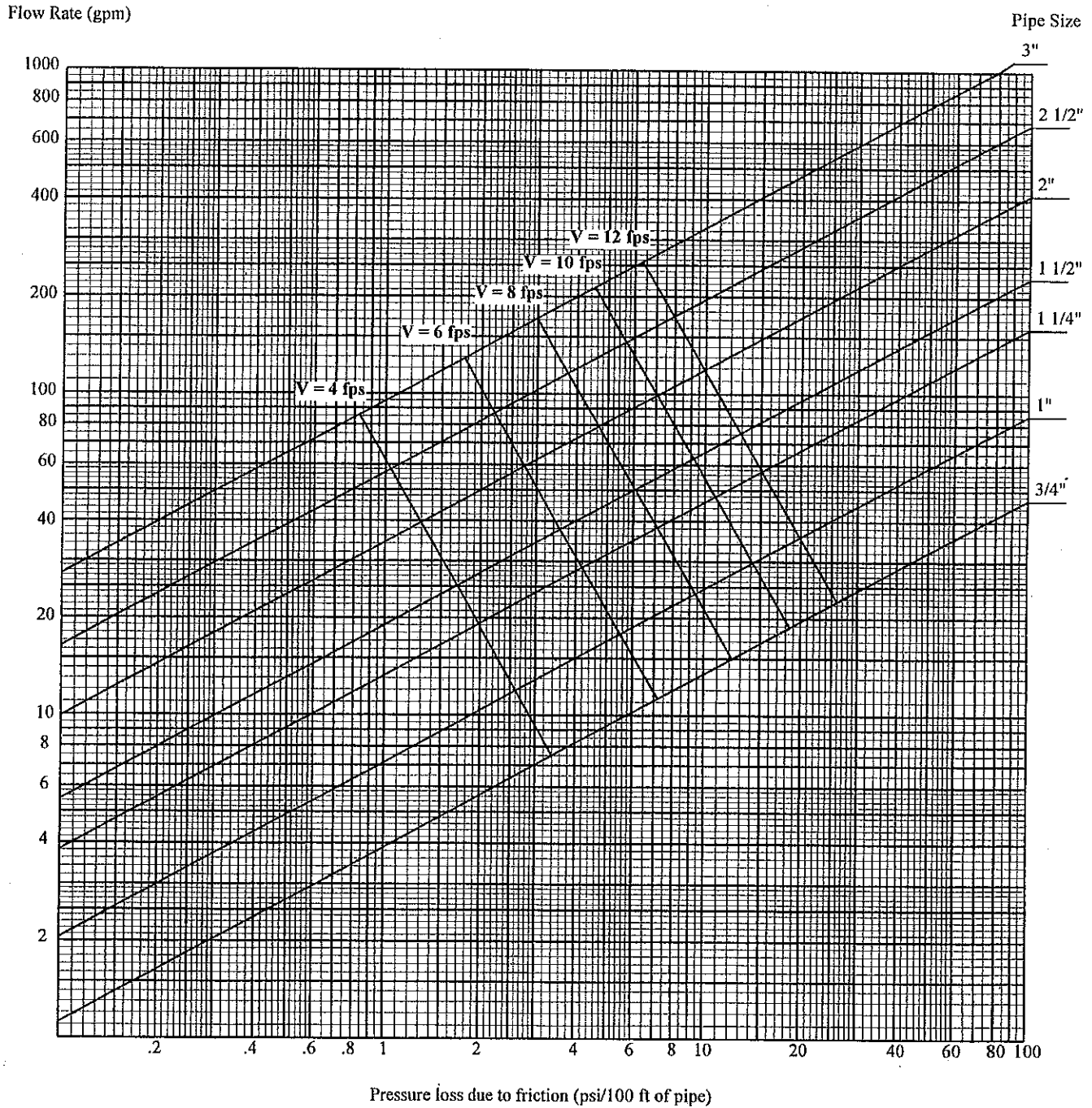

A-82.41 (3) CROSS CONNECTION CONTROL HISTORY.

CROSS CONNECTION CONTROL HISTORY TABLE

Application	Date	Code or Interpretation
Atmospheric vacuum breaker installation	1954	4 inch elevation above flood level of fixtures
	1979	6 inch elevation above flood level of fixtures
Shampoo Sinks	1977	ASSE 1001 6 inches above the flood level rim ASSE 1013 or ASSE 1012 serving several sinks
	3/1/94	Individual CCC required for each sink ASSE 1001 6 inches above highest point of use (19 inches) ASSE 1013 or ASSE 1056 12 inches above highest use ASSE 1014 approved faucet
Boilers	1977	ASSE 1012 for low pressures: 15 psig steam 30 psig water
	February 1986	ASSE 1012 for boilers: Pressure \leq 160 psig Rated working temperature \leq 250 degrees Actual temperature \leq 160 Pressure relief valve set at 30 psig max. Non-toxic additives Must not be in a hospital (hospital boilers require ASSE 1013)
	3/1/94	ASSE 1012 for low pressure (same) and non-toxic in mixed condition ASSE 1013 for high pressure or toxic
	12/1/04	Chemical pot feeder creates high hazard situation automatically
Laundry trays	1977	Residential – no CCC required on hose threads Commercial – ASSE 1001 required at 7'6"
	1987	Residential without hose threads – no additional device required Residential with hose threads – ASSE 1011 Commercial – ASSE 1001 @ 7'6" or ASSE 1011
	3/1/94	Residential without hose threads – no additional device required Residential with hose threads – ASSE 1011, ASSE 1001 @ 7'6" or ASSE 1052 Commercial – used for building maintenance with or without hose threads, same as residential with hose threads
Hose bibb for maintenance	1987	ASSE 1011 or ASSE 1001 @ 7'6"
	3/1/94	ASSE 1011 or ASSE 1019
Hose reels	1977	ASSE 1001 with stipulations or ASSE 1013
	3/1/94	ASSE 1020 (exterior only) with stipulations ASSE 1056 with stipulations or ASSE 1013
Sink overhead	1987	ASSE 1012 or Spring making cross connection impossible
Heat exchangers	1986	Double wall draining to atmosphere with toxic heat transfer fluids Single wall when non-toxic heat transfer fluids
Yard hydrants	July 1987	Sanitary hydrant with ASSE 1011 or ASSE 1012 serving only that hydrant and label hydrant as "non-potable" and hose threads protected with ASSE 1011
	9/1/01	Must be sanitary hydrant without below ground bleed
ASSE 1012	3/1/94	Limited to low degree of hazard

Application	Date	Code or Interpretation
ASSE 1019	3/1/94	Exterior wall hydrants must be frost proof and self draining The backflow protection must be integral to the hydrant
Dental units	October 1987	ASSE 1012 for each individual dental unit
	3/1/94	ASSE 1013 (high hazard designation)
Existing fire protection	2/1/94	Allow existing CCC to remain unless increase in diameter of H2O dist, or remove or replace CCC

A-82.41 (5) (a) AIR-GAP. An air-gap for cross connection control for water supply systems conforming to ASME 112.1.2.

Section Comm 81.01 (7) reads: "Air-gap, water supply system,' means the unobstructed vertical distance through the free atmosphere between the lowest opening from any pipe or faucet supplying water to a tank or plumbing fixture and the flood level rim or spill level of the receptacle."

A pipe/spout that terminates with its outlet above the flood level rim of a receptacle/fixture:

1. Shall terminate a minimum of one inch above the flood level rim of the receptacle/fixture, or
2. Shall terminate a minimum distance of two times the diameter of the effective opening from the end of the pipe/spout to the flood level rim of the receptacle/fixture.

Note: In any case, regardless if the end of the pipe/spout is cut square or at an angle, the air-gap is the distance between the lowest end of the pipe/spout and the flood level rim of the receptacle/fixture.

The following water supply air-gap, although the least desirable, is acceptable to the ASME 112.1.2 standard. A pipe/spout that terminates with its outlet completely below the flood level rim of a receptacle/fixture:

1. Must have an opening in the receptacle/fixture that discharges to the atmosphere through an air-gap.
2. This air-gap must be located as close as possible to the receptacle/fixture.
3. The rate of discharge through this opening as compared to the rate of water entering the receptacle/fixture establishes a "spill level" that is the level at which water entering the receptacle/fixture seeks a balance and does not raise any higher. (A level is established where the flow of water entering equals the flow of water exiting.)
4. The distance then, between this established "spill level" and the end of the lowest water supply pipe/spout, is the air-gap.
5. The minimum air-gap ("Y") is the distance between the supply pipe/spout and the "spill level" established in the receptacle/fixture.
6. The "spill level" shall be a distance no greater than one half of the distance measured as "Y," ($\frac{1}{2}$ "Y") above the discharge opening in the receptacle/fixture. Therefore, the air-gap between the supply pipe/spout and the highest portion of the opening that discharges to the atmosphere shall be a distance no greater than one and one half "Y" ($1 \frac{1}{2}$ "Y").

Note: In any case, regardless if the end of the pipe/spout is cut square or at an angle, the air-gap is the distance between the lowest end of the pipe/spout and the "spill level" of the receptacle/fixture.

The measurement for this air-gap, however, could be as much as 3 times the diameter of the pipe/spout depending upon the number of near walls. The distance of a near wall is a relationship to the diameter of the pipe/spout and the measurement from the wall to the closest side of the pipe/spout:

1. If there is one near wall, and the distance between that near wall and the closest edge of the supply pipe/spout is greater than 3 times the diameter of the supply pipe/spout, then the minimum air-gap is 2 times the diameter of the supply pipe/spout.
2. If there is one near wall, and the distance to the closest edge of the supply pipe/spout is less than 3 times the diameter of the pipe/spout, then the minimum air-gap is 3 times the diameter of the supply pipe/spout.

3. If there are 2 near walls, and the distance between the near wall(s) and closest edge of the supply pipe/spout is greater than 4 times the diameter of the supply pipe/spout, then the minimum air-gap is 2 times the diameter of the supply pipe/spout.
4. If there are 2 near walls, and the distance to the closest edge of the supply pipe/spout is less than 4 times the diameter of the supply pipe/spout, then the minimum air-gap is 3 times the diameter of the supply pipe/spout.

It has been determined that 2 or more near walls generally have little effect on the need to increase the air-gap to more than 3 times the diameter of the supply pipe/spout.

Note: See the following sketches as examples of an air-gap with pipe/spouts terminating above the flood level rim of the receptacle/fixture, of an air-gap with pipe/spouts terminating below the flood level rim of the receptacle/fixture and of an air-gap with pipe/spouts when terminating by one near wall.

A-82.41 (5)-1. AIR-GAP WITH PIPE/SPOUT(S) ABOVE FLOOD LEVEL RIM OF RECEPTACLE/FIXTURE.

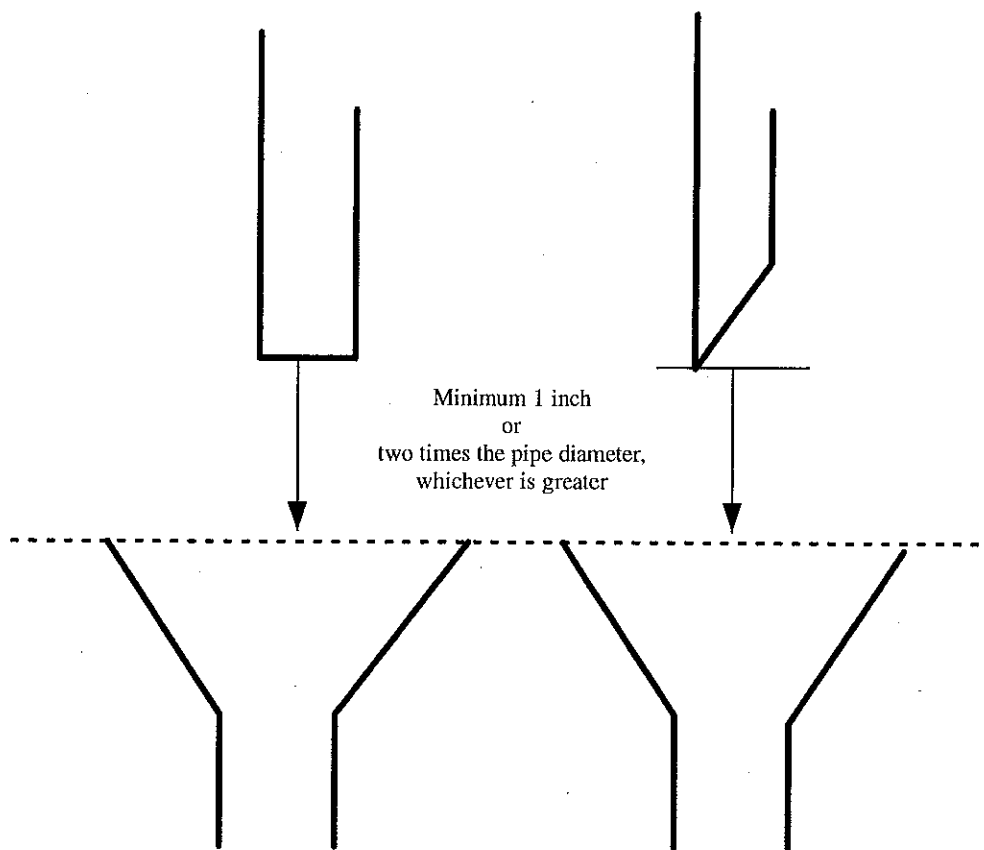

WATER SUPPLY AIR-GAP ASME 112.1.2

A-82.41(5)-2. AIR-GAP WITH PIPE/SPOUT(S) BELOW FLOOD LEVEL RIM OF RECEPTACLE/FIXTURE.

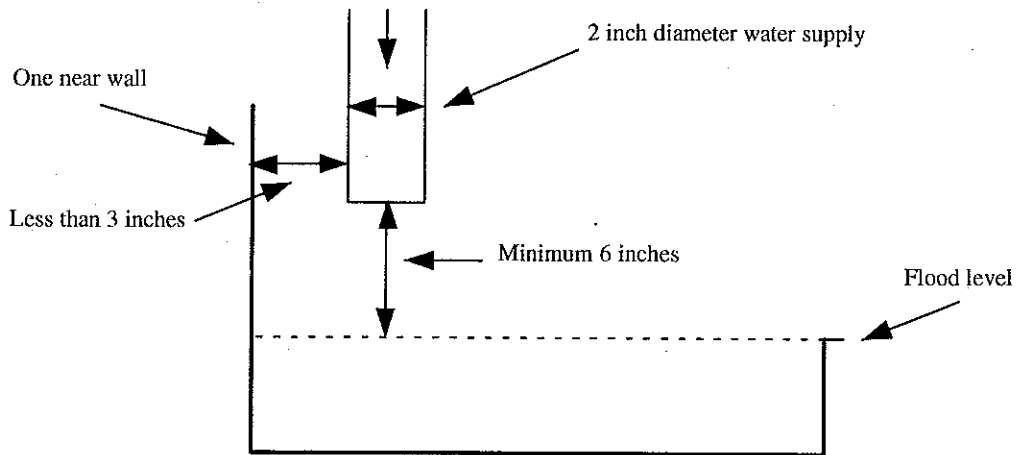
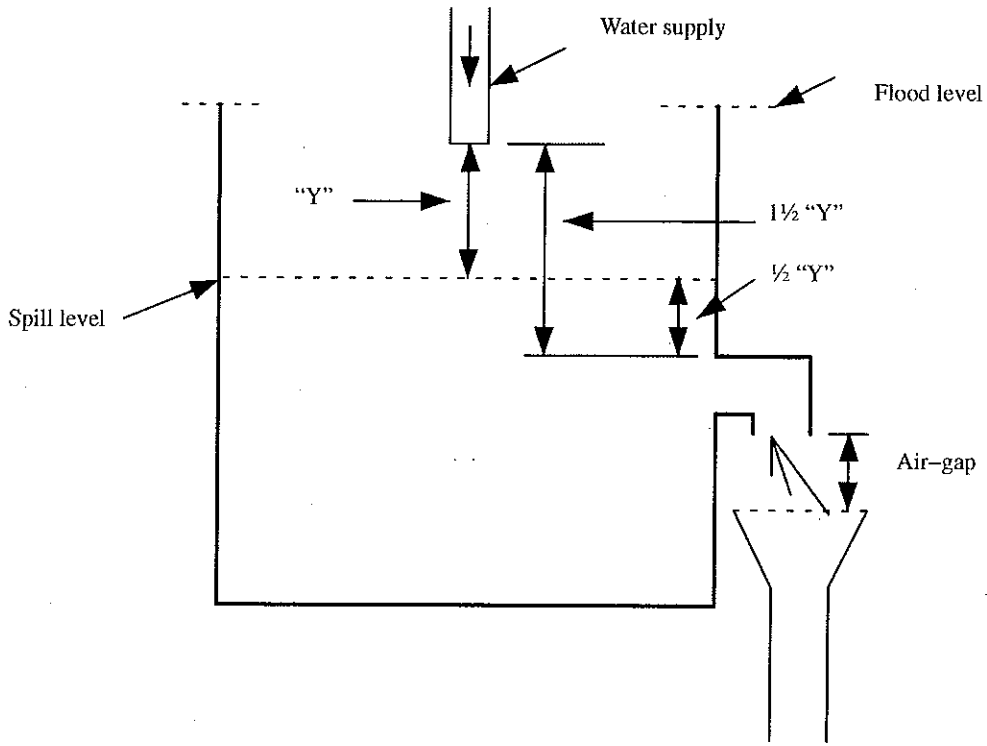

If distance is 3 times or greater than the diameter of water supply (2 inch), then the air-gap is 2 times the diameter of the water supply, (i.e., $2 \times 2 = 4$ inches)

If the distance is less than 3 times the diameter of the water supply (2 inch), then the air-gap is 3 times the diameter of the water supply, (i.e., $3 \times 2 = 6$ inches)

A PARTIAL TABLE FOR THE SELECTION OF BACKFLOW PROTECTION *

Situation	Hazard	Air-gap	ASSE 1001	ASSE 1011	ASSE 1012	ASSE 1013	ASSE 1014	ASSE 1019	ASSE 1020	ASSE 1022	ASSE 1035	ASSE 1052	ASSE 1055	ASSE 1056
Autoclave/sterilizer ¹	Low				X									
Autoclave/sterilizer ²	High					X								X
Boiler	Low				X									
Boiler	High					X								
Building maintenance sink ³	High		X	X		X						X		X
Carbonated beverage dispenser	High									X				
Cappuccino machine	Low				X					X				
Chemical dispensing system ⁴	High	X	X			X							X	X
Commercial dish-washer	High		X			X								X
Commercial clothes washer	High	X	X			X								X
Commercial overhead hose reel	High					X								
Dental unit/chain ⁵	High					X								X
Espresso machine	Low				X					X				
Exterior wall hydrants	High							X						
Food waste grinder	High		X			X								X
Handheld showers	High		X				X							
Hose threaded outlets ⁶	High			X								X		
Humidifier	Low	X			X									
Kidney dialysis machine	High					X								X
Laboratory sink faucet ⁷	High		X								X	X		
Photo developing machine	High					X								X
Proofing oven	Low				X									
Shampoo/barber sink ⁸	High		X			X	X							X
Swimming pools	High	X	X	X		X		X	X			X		X
Therapeutic pools	High	X	X	X		X		X	X					X
Wading pools	High	X	X	X		X		X	X					X
Water cooled compressors	High					X								X
X-ray developing machine	High					X								X
Yard hydrants ⁹	High			X								X		

*Any situation may be subject to an alternate approval.

¹ If less than 15 pounds steam or 30 pounds water and nontoxic chemicals.

² If greater than 15 pounds steam or 30 pounds water and toxic chemicals.

³ Requires backflow protection even if there is a plain end spout.

⁴ Requires separate water supply terminating without a hose thread, or the manufacturer must provide a bleed device to connect to the janitor sink faucet spout.

⁵ Or, provide bottled water conversion unit.

⁶ For outlets other than the required ASSE 1019 hydrants.

⁷ If provided with hose threads or serrated nipple.

⁸ Faucet meeting ASME A112.18.1M that includes backflow protection requirements.

⁹ Hydrants that bleed into the ground and hydrants that are flush with the grade are prohibited.

A-82.41 (5) (f)-1. CROSS CONNECTION CONTROL ASSEMBLY INSTALLATION.

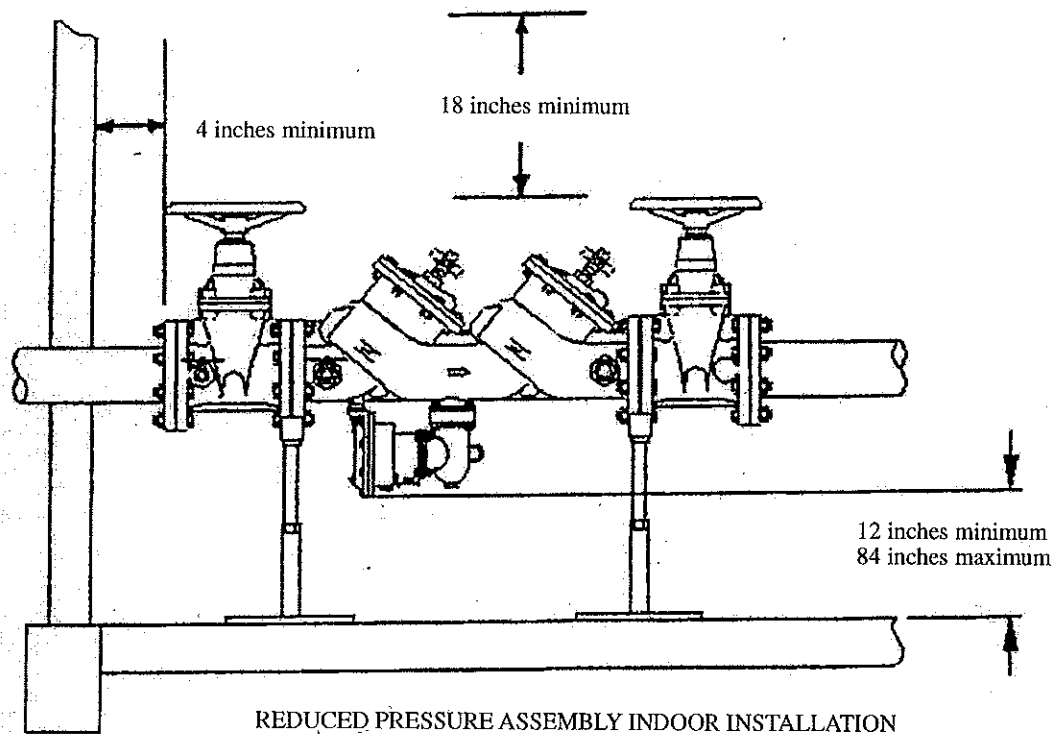
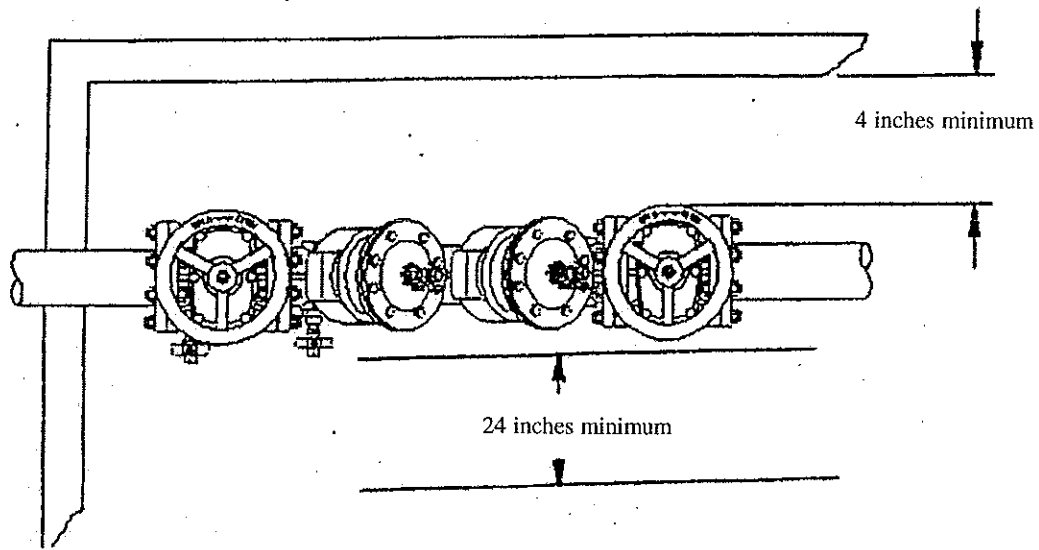

A-82.41 (5) (f)-2. CROSS CONNECTION CONTROL ASSEMBLY INSTALLATION.

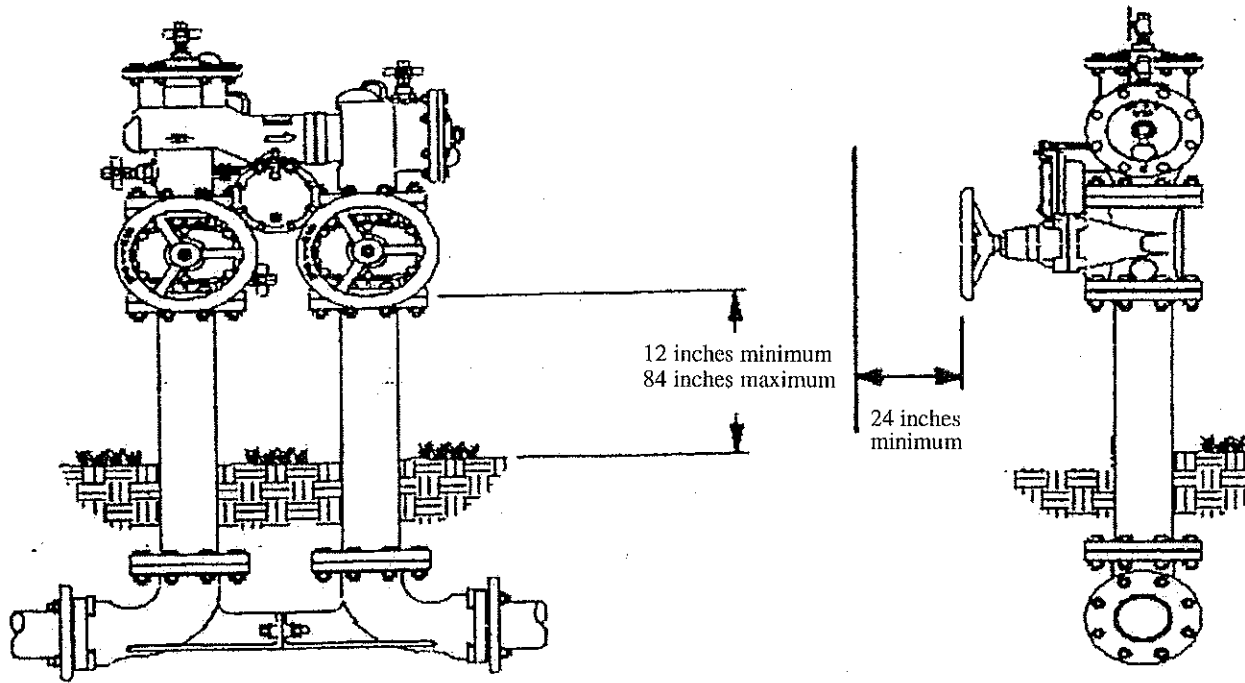

REDUCED PRESSURE ASSEMBLY OUTDOOR INSTALLATION

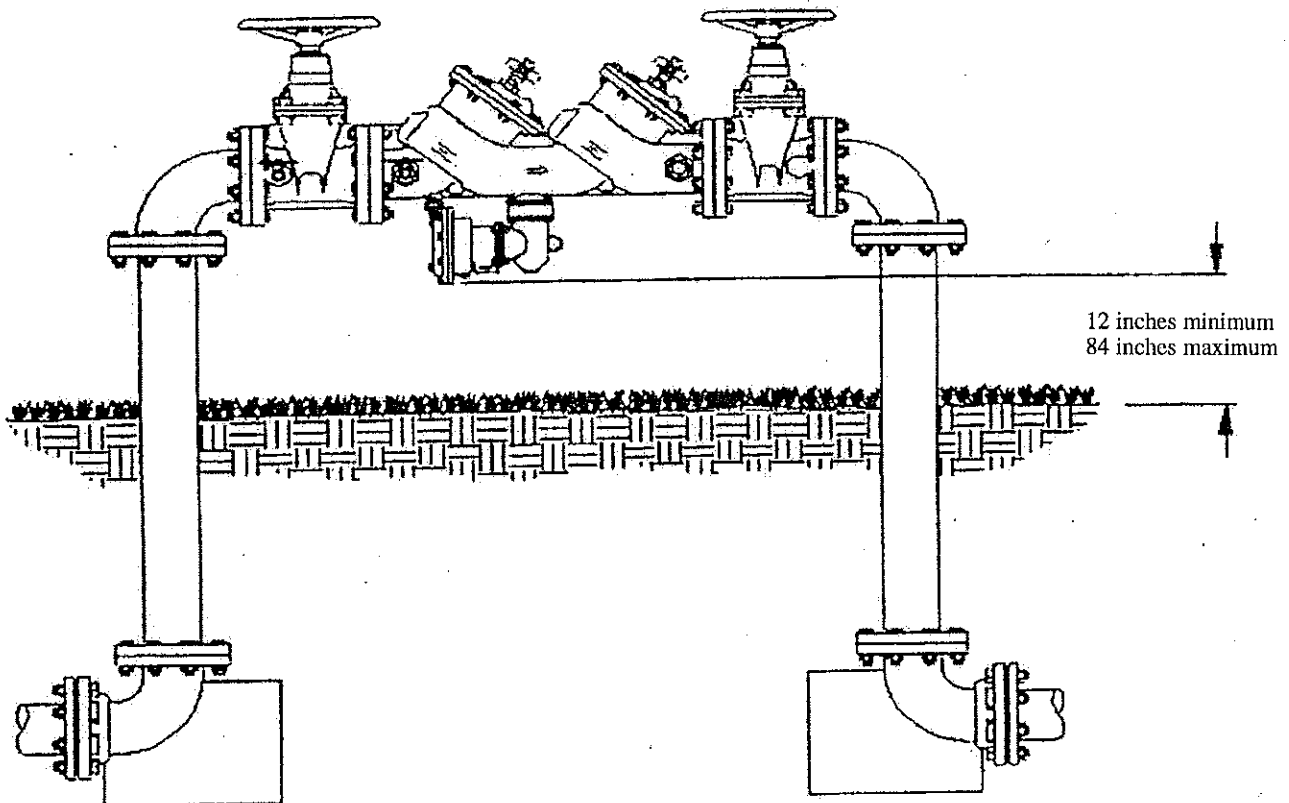

REDUCED PRESSURE ASSEMBLY OUTDOOR INSTALLATION

A-82.41 (5) (f)-3. CROSS CONNECTION CONTROL ASSEMBLY INSTALLATION.

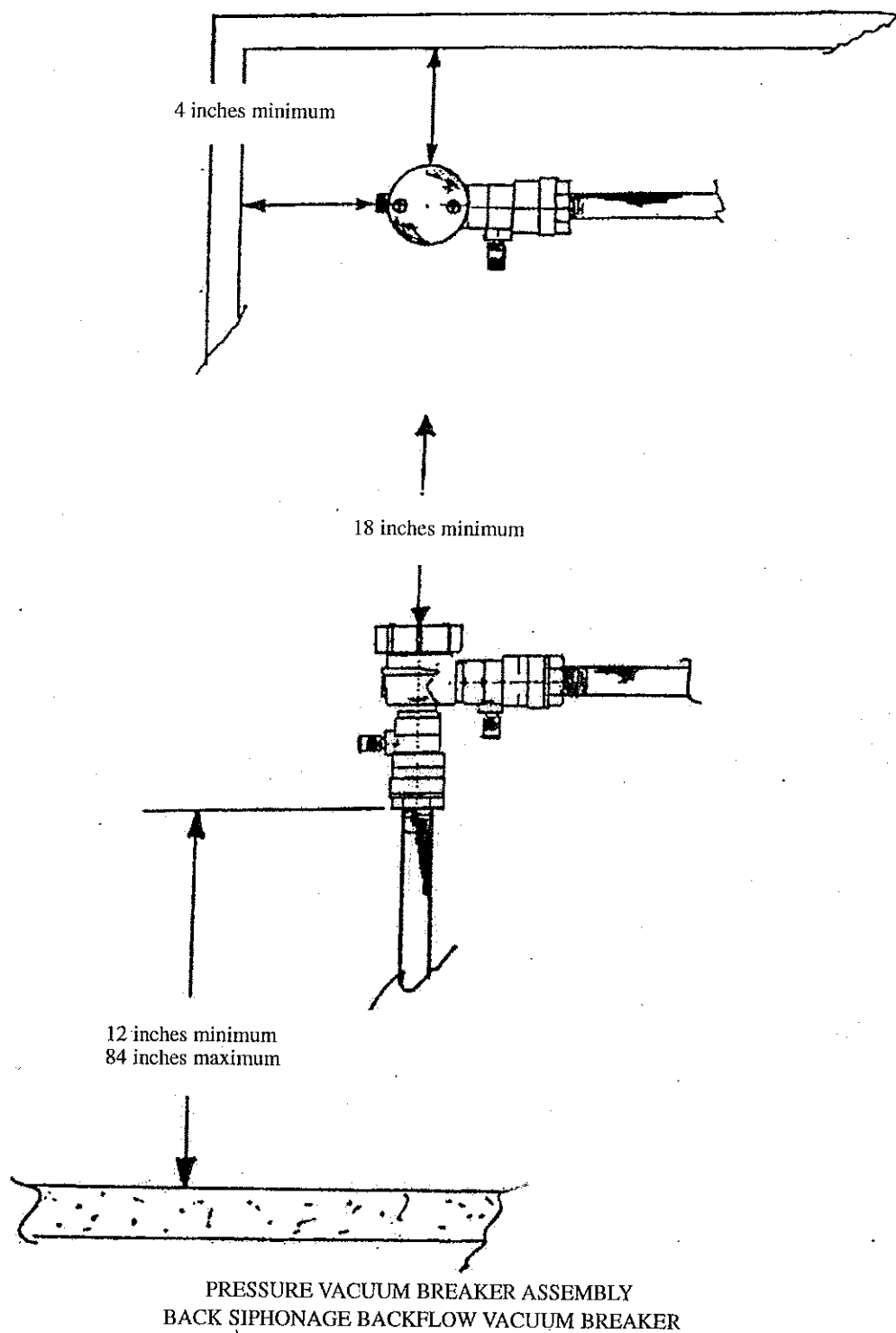

A-82.41 (5) (f)-4. CROSS CONNECTION CONTROL ASSEMBLY INSTALLATION.

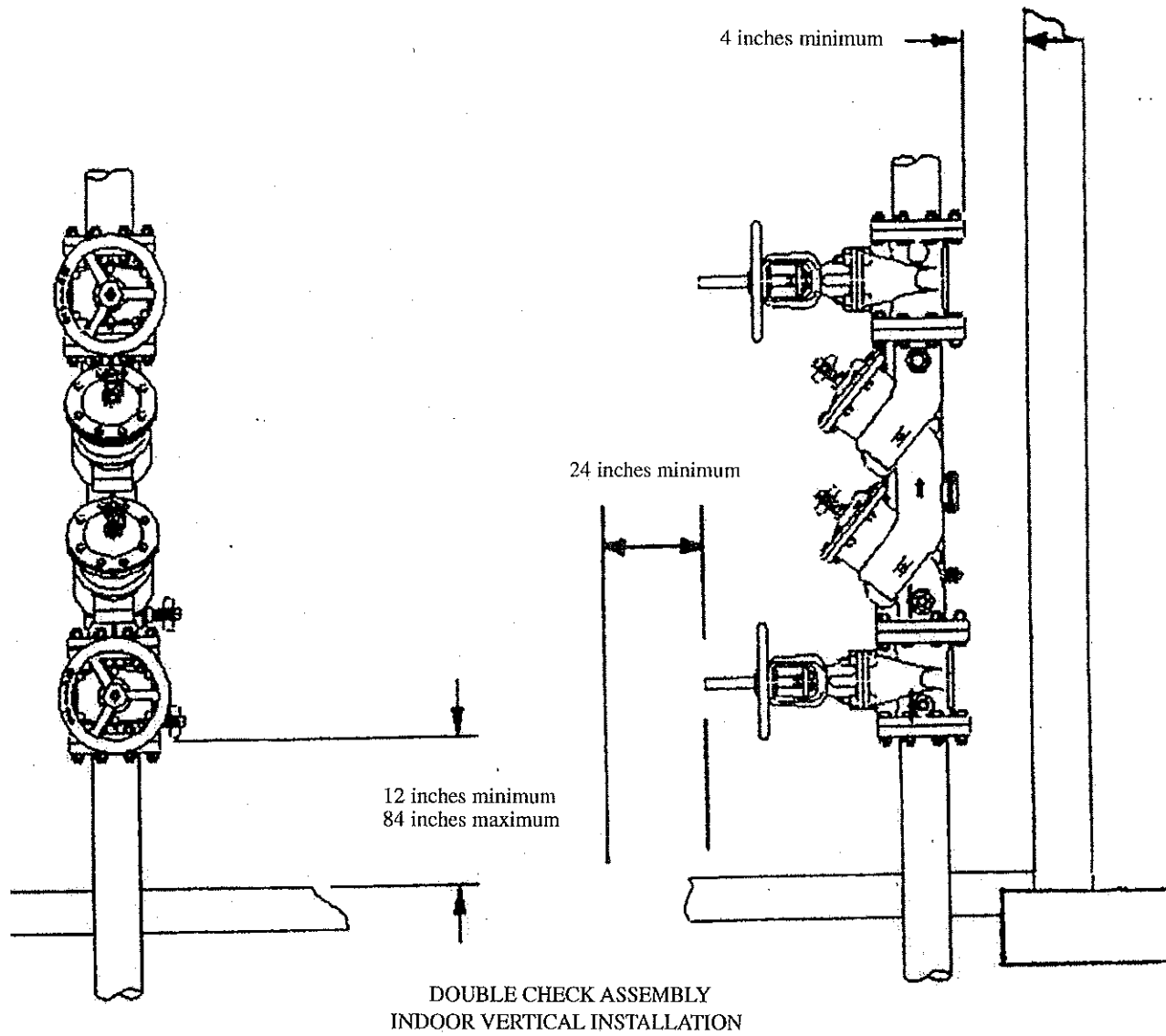

A-82.41 (5) (f)-5. CROSS CONNECTION CONTROL ASSEMBLY INSTALLATION.

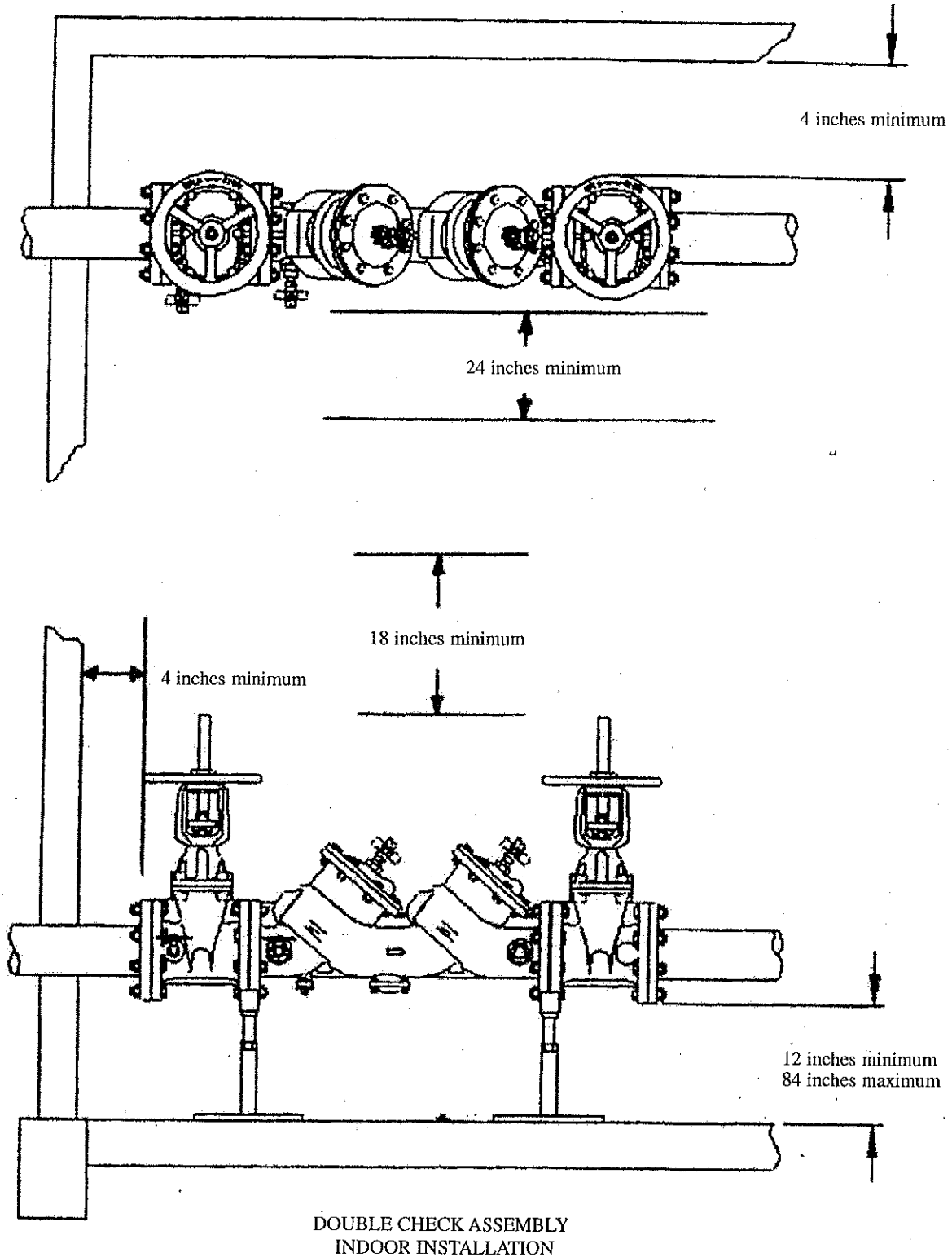

A-82.50 (3) (b) 5. OPTIONS FOR TEMPERATURE CONTROL IN HEALTH CARE FACILITIES. The following sketches provide options for fail safe installations at the bathing and shower fixture and temperature control at hand-washing fixtures.

Option 1. Fail safe solenoid provided at main mixer meeting ASSE 1017, pressure balanced tub/shower valve meeting ASSE 1016 and limit stop faucets at lavatory and kitchen sink.

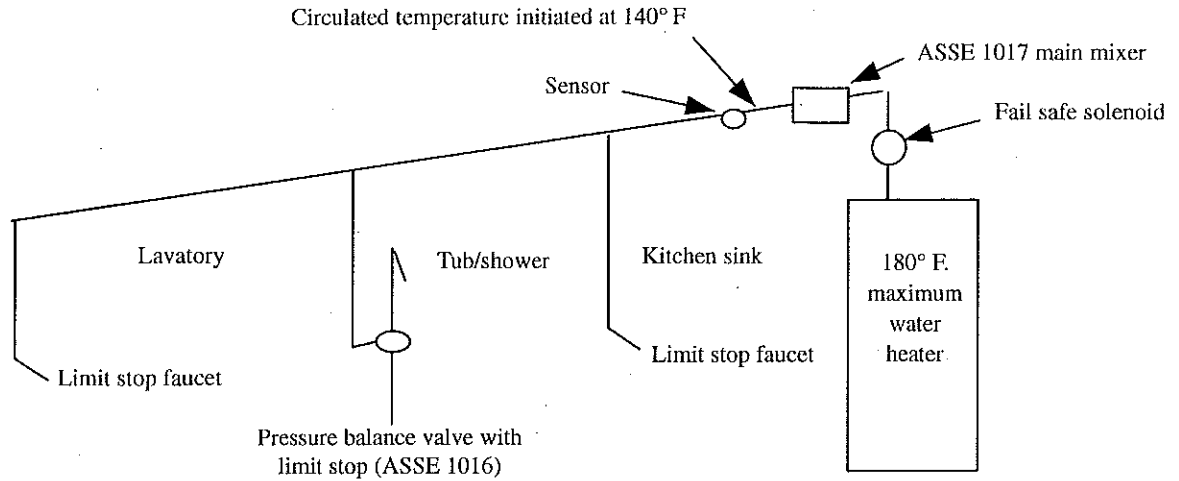

Option 2. Fail safe solenoid provided at main mixer meeting ASSE 1017, pressure balanced tub/shower valve meeting ASSE 1016 and thermostatic mixer meeting ASSE 1016 at lavatory and kitchen sink faucets.

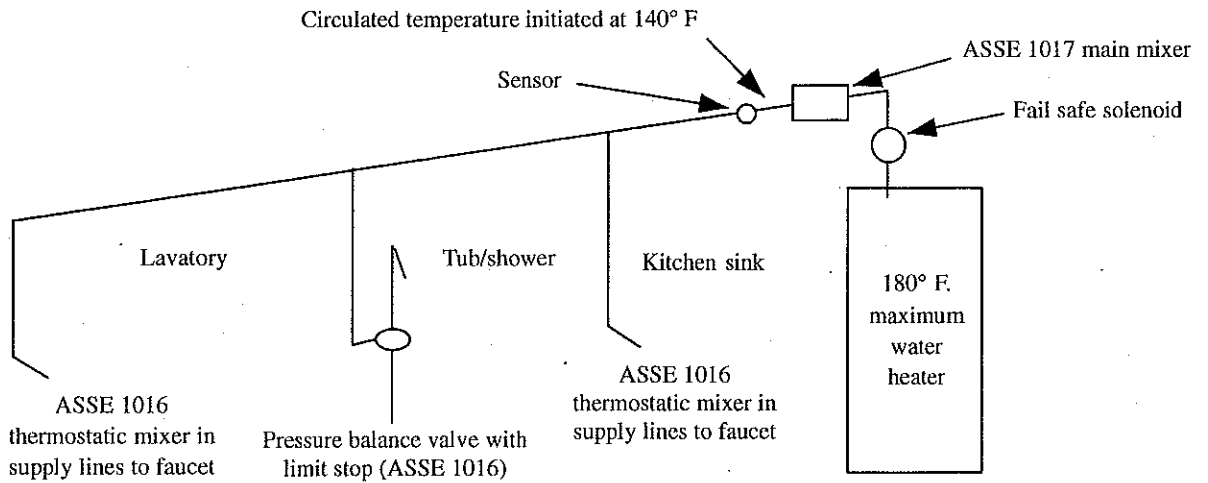

Option 3. Fail safe solenoid provided at main mixer meeting ASSE 1017, thermostatic tub/shower valve meeting ASSE 1016 and limit stop faucets at lavatory and kitchen sink.

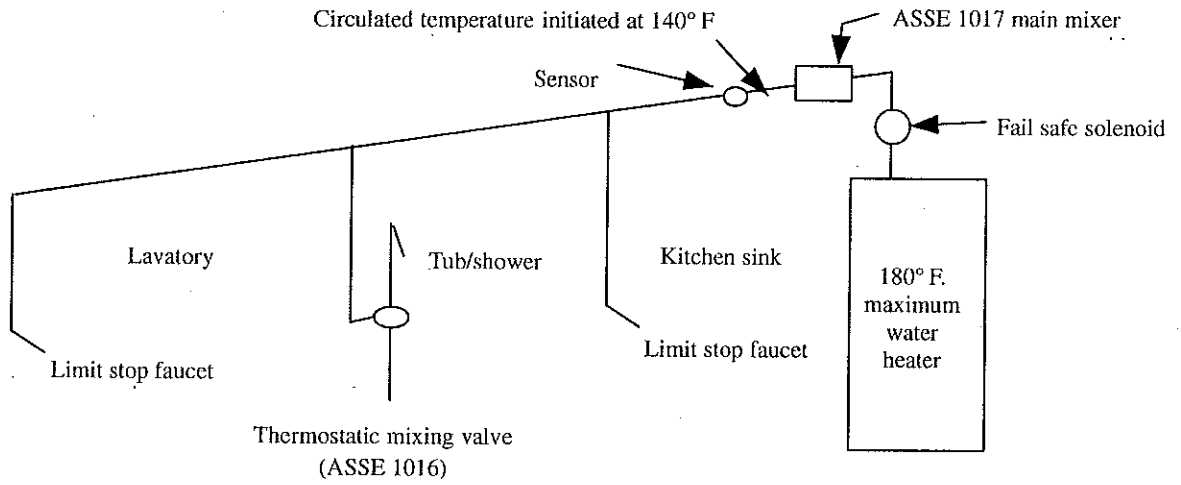

Option 4. Fail safe solenoid provided at main mixer meeting ASSE 1017, combination thermostatic/pressure balance mixing valve meeting ASSE 1016 and limit stop faucets at lavatory and kitchen sink.

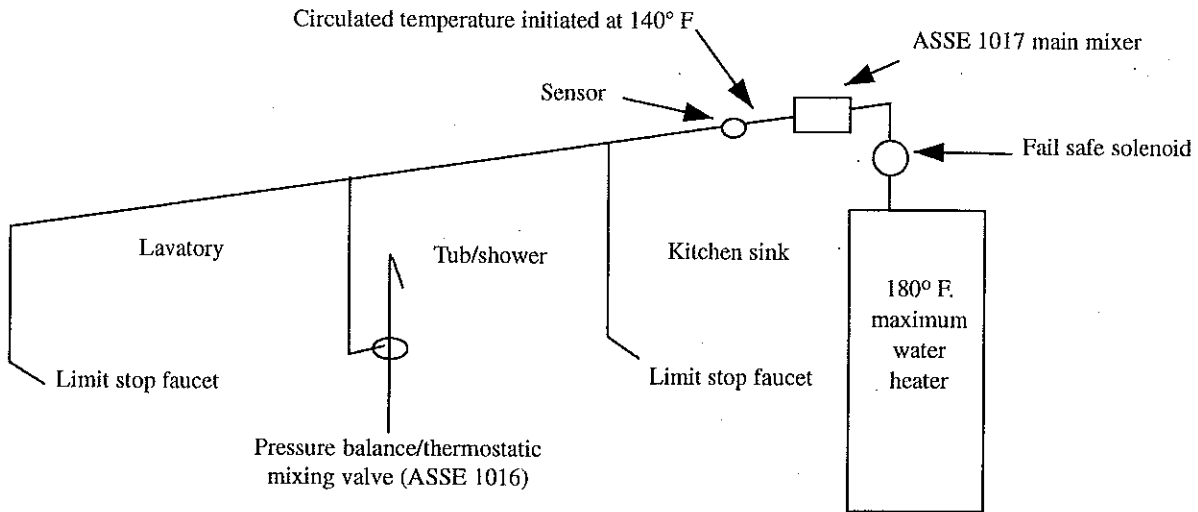

Option 5. Fail safe solenoid, combination pressure balanced/thermostatic tub/shower valve meeting ASSE 1016 and thermostatic mixer meeting ASSE 1016 at lavatory and kitchen sink faucets.

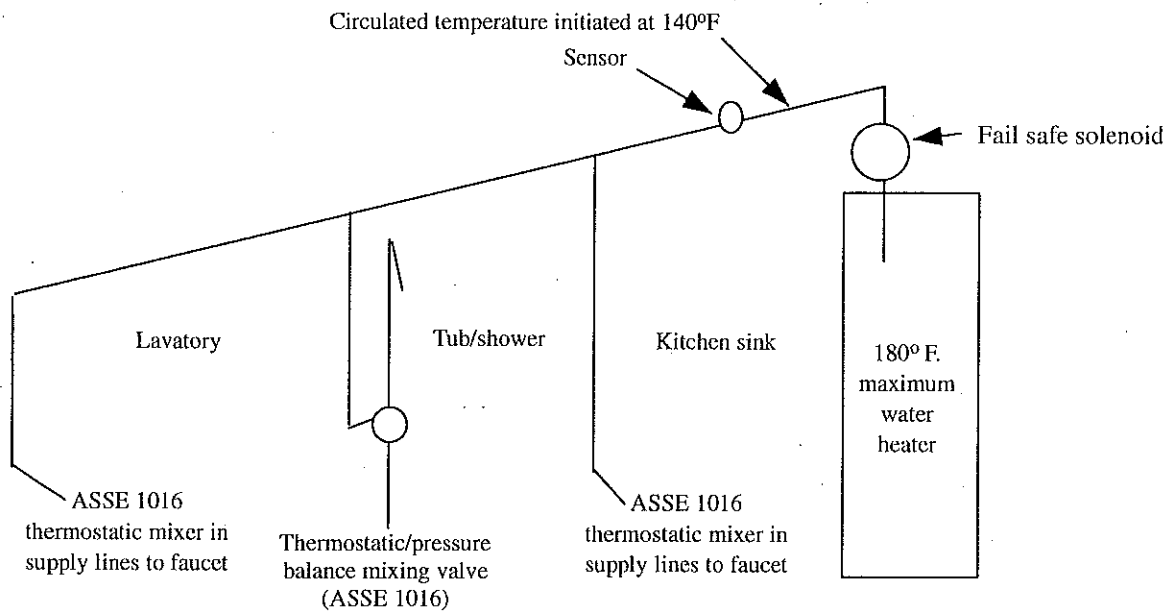

A-82.51 (3) MOBILE HOME SITES AND PARKS. Mobile home building sewer and water service connections.

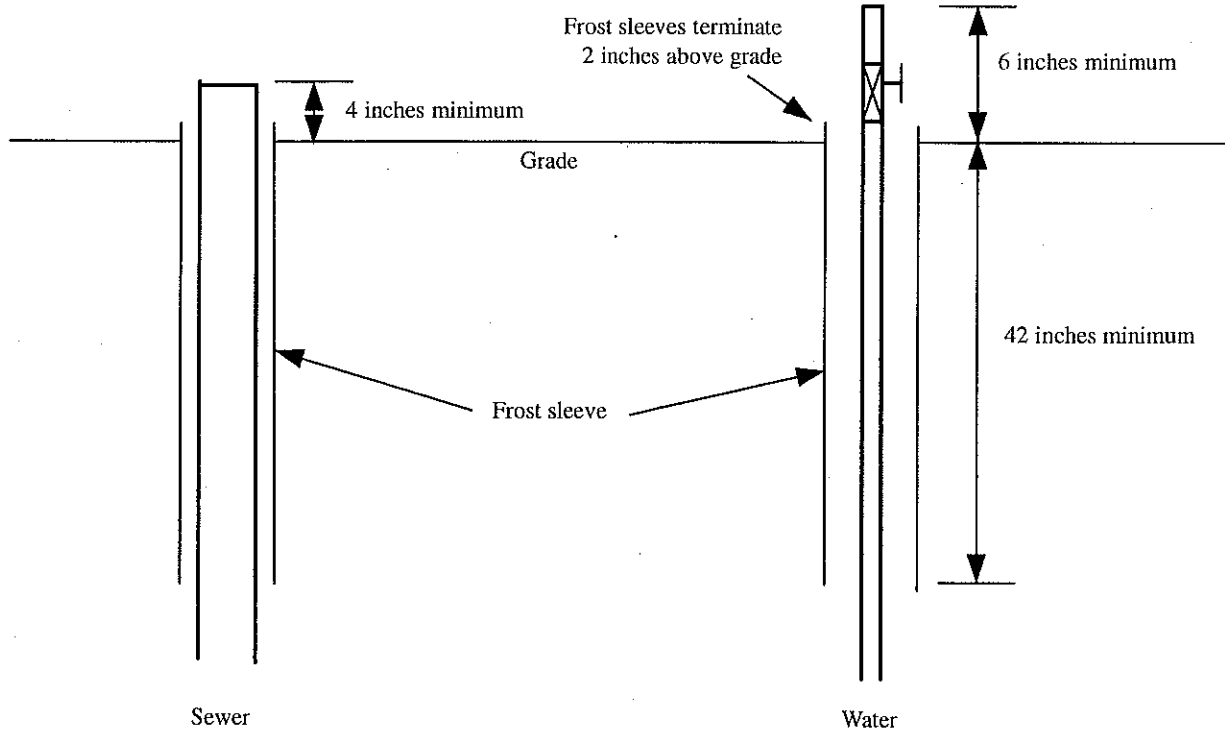

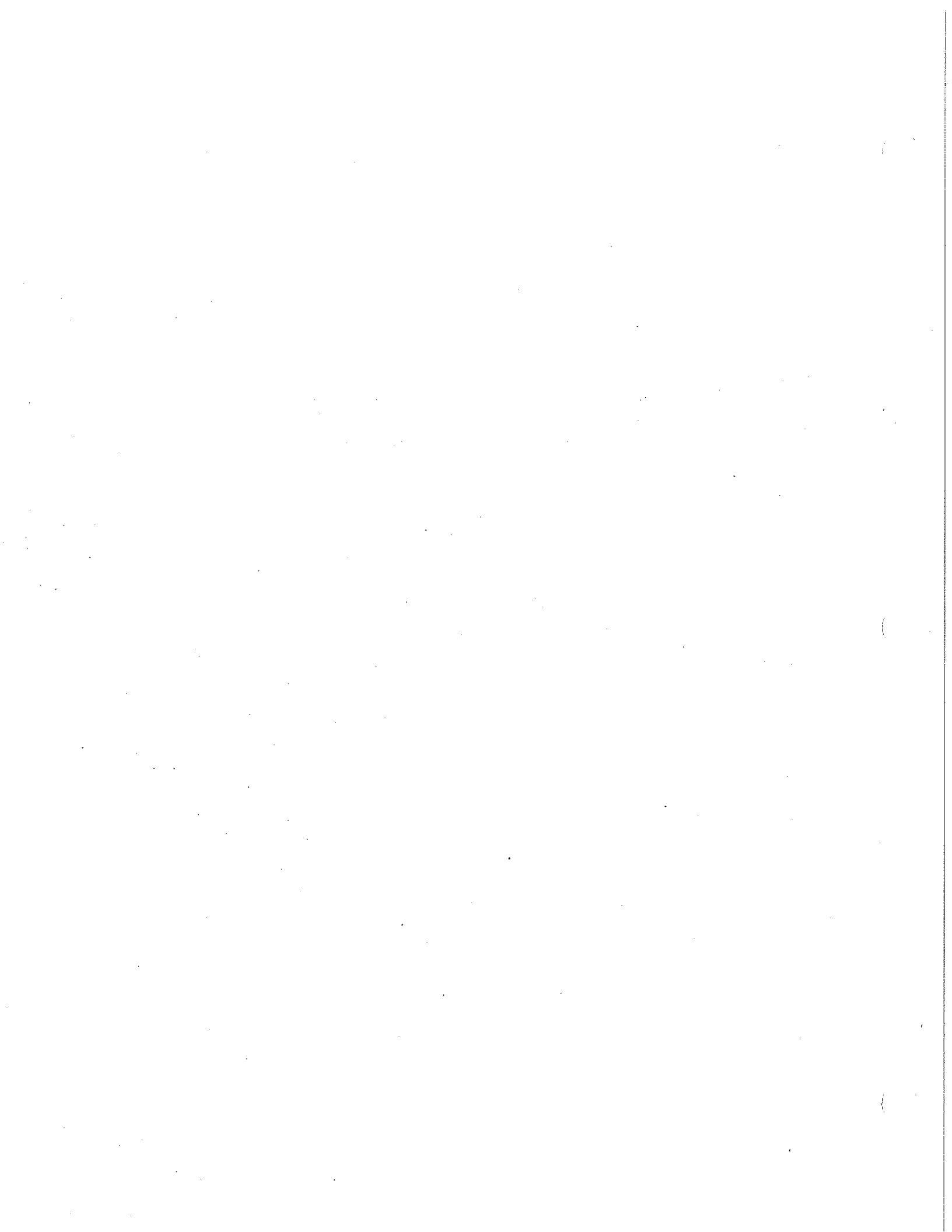

Chapter Comm 84

PLUMBING PRODUCTS

Comm 84.01 Scope.
 Comm 84.02 Penalties.
 Comm 84.03 Definitions.
 Comm 84.10 Department approval.
 Comm 84.11 Device listing.
 Comm 84.12 Identification.
 Comm 84.13 Penetrations of fire-resistive assemblies.

Comm 84.14 Chemical or biochemical treatments for private sewage systems.
 Comm 84.15 Health care plumbing appliances.
 Comm 84.20 Plumbing fixtures, appliances and equipment.
 Comm 84.25 POWTS holding components or treatment components.
 Comm 84.30 Plumbing materials.
 Comm 84.40 Joints and connections.
 Comm 84.50 Alternate approvals and experimental approvals.

Note: Chapter ILHR 84 as it existed on May 31, 1988 was repealed and a new chapter ILHR 84 was created effective June 1, 1988. Chapter ILHR 84 was renumbered Comm 84 under s. 13.93 (2m) (b) 1., Stats., and corrections made under s. 13.93 (2m) (b) 7., Stats., Register, February, 1997, No. 494.

Comm 84.01 Scope. (1) The provisions of this chapter govern the quality and installation of materials, fixtures, appliances, appurtenances, and equipment relating to plumbing.

(2) A department interpretation of the requirements in this chapter shall supersede any differing interpretation by a lower level jurisdiction. A department decision on the application of the requirements in this chapter shall supersede any differing decision by a lower level jurisdiction.

Note: A decision of the department may be appealed. Section 101.02 (6) (e), Stats., outlines the procedure for submitting requests to the department for appeal hearings and the department procedures for hearing appeals.

History: Cr. Register, May, 1988, No. 389, eff. 6-1-88; CR 07-100: renum. to (1), cr. (2) Register September 2008 No. 633, eff. 10-1-08.

Comm 84.02 Penalties. Penalties for violations of this chapter shall be assessed in accordance with s. 145.12, Stats.

History: Cr. Register, May, 1988, No. 389, eff. 6-1-88; correction made under s. 13.93 (2m) (b) 7., Stats., Register, July, 2000, No. 535.

Comm 84.03 Definitions. In this chapter:

(1) "Health care plumbing appliance" means a plumbing appliance, the function of which is unique to health care activities.

(2) "Laboratory plumbing appliance" means a plumbing appliance, the function of which is unique to scientific experimentation or research activities.

(3) "Prefabricated plumbing" means concealed drain piping, vent piping or water supply piping or a combination of these types of piping, contained in a modular building component, which will not be visible for inspection when delivered to the final site of installation.

History: Cr. Register, May, 1988, No. 389, eff. 6-1-88.

Comm 84.10 Department approval. No fixture, appliance, appurtenance, material, device or product may be sold for use in a plumbing system or may be installed in a plumbing system, unless it is of a type conforming to the standards or specifications of chs. Comm 82 and 83 and this chapter and ch. 145, Stats.

(1) **ALTERNATE OR EXPERIMENTAL PRODUCT APPROVAL.** If it is alleged that the approval of a fixture, appliance, appurtenance, material, device or product under this section would result in an adverse health effect or potentially adverse health effect on the waters of the state, the department may require an alternate or experimental product approval under s. Comm 84.50.

(2) **PRODUCT REVIEW AND APPROVAL.** (a) 1. Each type of plumbing product which falls into one of the categories specified in Table 84.10 shall be approved by the department in accordance with this subsection before the product may be sold for use in a plumbing system or installed in a plumbing system.

2. Specifications and plans or drawings for each type of product shall be submitted to the department for review. The submittal shall be accompanied by sufficient data and information to deter-

mine if the product and its performance comply with the provisions of chs. Comm 82, 83 and this chapter and ch. 145, Stats.

(b) The department may require that a submitter of a product for review have the product tested and its performance certified by an approved testing laboratory.

(c) If, upon review, the department determines that a product conforms to the provisions of chs. Comm 82, 83 and this chapter and ch. 145, Stats., the department shall issue an approval in writing. The department may impose specific conditions in granting an approval. Violations of the conditions under which an approval is granted shall constitute a violation of this chapter.

(d) If, upon review, the department determines that a product does not conform to provisions of chs. Comm 82, 83 and this chapter and ch. 145, Stats., the request for approval shall be denied in writing.

(e) The department shall review and make a determination on an application for a product approval within 40 business days of receipt of all fees, plans, drawings, specifications and other information required to complete the review.

(f) If an approved plumbing product is modified or additional assertions of function or performance are made, the approval shall be considered null and void, unless the change is submitted to the department for review and the approval is reaffirmed.

(g) Approvals for plumbing products issued by the department prior to November 1, 1985, shall expire 30 months after the effective date of this section.

(h) Approvals for plumbing products issued by the department after November 1, 1985, shall expire at the end of the 60th month after the date of approval issuance.

Table 84.10
SUBMITTALS TO DEPARTMENT

Product Categories	
1.	Chemical or biochemical treatments for POWTS
2.	Health care plumbing appliances
3.	Physical restoration processes for POWTS
4.	Prefabricated holding or treatment components for POWTS
5.	Prefabricated plumbing
6.	Water treatment devices or bottled water vending machines not listed by a nationally recognized listing agency as complying with NSF Standard 44
7.	Wastewater treatment devices used to meet the requirements in s. Comm 82.70

(3) **VOLUNTARY POWTS COMPONENT REVIEW.** (a) The department may issue an approval, upon request and review, for specific methods or technologies that are proposed to be utilized as POWTS holding, treatment or dispersal components which conform to the standards or specifications referenced in chs. Comm 81, 82, 83 and this chapter, but do not require approval under sub. (2) or s. Comm 84.50.

(b) Each request for approval shall be made on a form provided by the department.

Note: See appendix for a reprint of the form and addresses of the department where the form may be obtained.

(c) The submittal shall be accompanied by sufficient data and information to determine if the method or technology complies with the provisions of chs. Comm 81, 82 and 83, and this chapter. The submittal shall include, but not be limited to, all of the following:

1. Plans and specifications.
2. Theory of operation.
3. Testing protocol.
4. Testing data.
5. Limits of reliable operation.
6. Installation requirements and procedures.
7. Inspection checklist and worksheet.
8. Inspection requirements and procedures.
9. Operation and maintenance requirements.
10. Operation and maintenance schedule.
11. Operation and maintenance checklist and worksheet.

(d) 1. The department shall review a submittal under this subsection with input from a technical advisory committee.

2. The members on the technical advisory committee under subd. 1. shall be appointed by the department for staggered 3-year terms and shall include representatives of at least the following groups or organizations:

- a. The department of natural resources.
- b. Local governmental unit.
- c. POWTS designer.
- d. Academic or scientific community.
- e. Plumber.
- f. Environmental group.
- g. POWTS component manufacturer.

(e) 1. After review by the technical advisory committee under par. (d) but prior to issuing an approval under par. (f), the department shall seek public comments on a submittal under this subsection.

2. a. The department shall place the notice requesting public comment under subd. 1. in the official state newspaper.

Note: The official state newspaper at the time this rule goes into effect, July 1, 2000, is the Wisconsin State Journal.

b. The department shall include a time limit for public comment in each notice.

3. If the department receives a significant amount of public comment under subd. 2., the department may elect to recognize the specific method or technology through the rule-making process under ch. 227, Stats., and to cite the recognition in s. Comm 83.61.

(f) 1. If, upon review, the department determines that the method or technology conforms to the provisions of chs. Comm

81, 82 and 83 and this chapter, the department shall issue an approval in writing.

2. The department may impose specific conditions in granting an approval, including a provision to provide training to POWTS installers and POWTS inspectors.

3. Violations of the conditions under which an approval is granted shall constitute a violation of this chapter.

(g) If, upon review, the department determines that the method or technology does not conform to the provisions of chs. Comm 81, 82 and 83 and this chapter, the request for approval shall be denied in writing.

(h) The department shall review and make a determination on an application for a method or technology approval within 3 months of receipt of all fees, plans, drawings, specifications and other information required to complete the review, unless the department elects to review the method or technology as part of the rule-making process under ch. 227, Stats.

(i) If an approved method or technology is modified or additional assertions of function or performance are made, the approval shall be considered null and void, unless the change is submitted to the department for review and the approval is reaffirmed.

(4) **REVOCAION.** The department may revoke any approval issued under this section for any false statements or misrepresentation of facts on which the approval was based, or as a result of the product's failure, or if data indicate a health hazard or threat to the waters of the state.

(5) **LIMITATIONS.** An approval of a plumbing product by the department may not be construed as an assumption of any responsibility for defects in design, construction or performance of any product nor for any damages that may result. All products shall be installed in accordance with the manufacturer's printed instructions and as specified in chs. Comm 82 to 84. If there is a conflict between the manufacturer's printed instructions and requirements of chs. Comm 82 to 84, the requirements of chs. Comm 82 to 84 shall take precedence.

(6) **FEES.** Fees for product approval review shall be submitted in accordance with s. Comm 2.66.

History: Cr. Register, May, 1988, No. 389, eff. 6-1-88; correction made in (6) under s. 13.93 (2m) (b) 7., Stats., Register, February, 1994, No. 458; emerg. am. Table 84.10, (2) (a) (intro.), r. (2) (a) 2., eff. 5-12-94; renum. (2) (a) (intro.), 1. and 2. to be 1., 2. and 3., r. (2) (a) 3., am. Table 84.10, Register, October, 1994, No. 466, eff. 11-1-94; am. Table 84.10 and r. and recr. (3), Register, April, 2000, No. 532, eff. 7-1-00; r. (2) (a) 2., renum. (2) (a) (intro.) and 1. to be (2) (a) 1. and 2. and am. (2) (a) 2., am. (5), (6) and Table 84.10, Register, July, 2000, No. 535, eff. 9-1-00; am. (4) and (5), Register, December, 2000, No. 540, eff. 1-1-01; CR 02-002: am. Table Register April 2003 No. 568, eff. 5-1-03; CR 04-035: am. Table 84.10 Register November 2004, eff. 12-1-04; CR 08-055: am. Table 84.10 Register February 2009 No. 638, eff. 3-1-09.

Comm 84.11 Device listing. Cross connection control devices and water treatment devices complying with the referenced standard in Table 84.11 shall be listed by a nationally recognized listing agency acceptable to the department.

Note: See appendix for acceptable listing agencies.

Table 84.11
DEVICE LISTINGS

Device	Referenced Standard
Anti-siphon Fill Valves (Ballcocks) for Gravity Water Closet Flush Tanks	ASSE 1002
Atmospheric Type Vacuum Breakers	ASSE 1001
Atmospheric Vacuum Breakers	CAN/CSA B64.1.1
Backflow Preventers for Beverage Dispensing Equipment	ASSE 1022
Backflow Preventer with Intermediate Atmospheric Vent	ASSE 1012
Backflow Prevention Devices for Hand-Held Showers	ASSE 1014
Chemical Dispensing Systems	ASSE 1055
Double Check Backflow Prevention Assemblies and Double Check Fire Protection Backflow Prevention Assemblies	ASSE 1015
Double Check Detector Fire Protection Backflow Prevention Assemblies	ASSE 1048
Double Check Valve Backflow Preventers	CAN/CSA B64.5
Dual Check Valve Backflow Preventers with Atmospheric Port	CAN/CSA B64.3
Hose Connection Backflow Preventers	ASSE 1052
Hose Connection Vacuum Breakers	CAN/CSA B64.2
Hose Connection Vacuum Breakers	ASSE 1011
Laboratory Faucet Backflow Preventers	ASSE 1035
Laboratory Faucet Type Vacuum Breakers	CAN/CSA B64.7
Pressure Vacuum Breakers	CAN/CSA B64.1.2
Pressure Vacuum Breaker Assembly	ASSE 1020
Pressurized Flushing Devices (Flushometers) for Plumbing Fixtures	ASSE 1037
Reduced Pressure Detector Fire Protection Backflow Prevention Assemblies	ASSE 1047
Reduced Pressure Principle Backflow Preventers and Reduced Pressure Fire Protection Principle Backflow Preventers	ASSE 1013
Reduced Pressure Principle Backflow Preventers	CAN/CSA B64.4
Spill Resistant Vacuum Breakers	ASSE 1056
Vacuum Breaker Wall Hydrants, Freeze Resistant Automatic Draining Type	ASSE 1019
Residential Cation Exchange Water Softeners	NSF 44

History: Cr. Register, July, 2000, No. 535, eff. 9-1-00; CR 02-002; am. Table Register April 2003 No. 568, eff. 5-1-03; CR 04-035; am. Table 84.11 Register November 2004 No. 587, eff. 12-1-04; CR 08-055; am. Table 84.11 Register February 2009 No. 638, eff. 3-1-09.

Comm 84.12 Identification. Each length of pipe and each pipe fitting, trap, fixture, material, device and product to be used in plumbing shall be marked as required by the applicable standard specified by reference in this chapter or as specified by rule in this chapter.

History: Cr. Register, May, 1988, No. 389, eff. 6-1-88; am. Register, April, 2000, No. 532, eff. 7-1-00; renum. from s. Comm 84.11, Register, July, 2000, No. 535, eff. 9-1-00.

Comm 84.13 Penetrations of fire-resistive assemblies. Penetrations of fire-resistive assemblies, such as walls and floor-ceiling systems, by plumbing systems or plumbing materials shall be protected in accordance with requirements of chs. Comm 61 to 65.

History: Cr. Register, May, 1988, No. 389, eff. 6-1-88; correction made under s. 13.93 (2m) (b) 7., Stats.; renum. from s. Comm 84.12, Register, July, 2000, No. 535, eff. 9-1-00; correction made under s. 13.93 (2m) (b) 7., Stats., Register June 2002 No. 558.

Comm 84.14 Chemical or biochemical treatments for private sewage systems. Chemical or biochemical treatments for private sewage systems shall function and perform in accordance with the assertions submitted to the department. Chemical or biochemical treatments for private sewage systems may not directly or indirectly adversely affect bacterial action in the systems, soil hydraulic conductivity in the absorption areas, or groundwater quality beneath the systems.

History: Cr. Register, May, 1988, No. 389, eff. 6-1-88; renum. from s. Comm 84.13, Register, July, 2000, No. 535, eff. 9-1-00.

Comm 84.15 Health care plumbing appliances. Health care plumbing appliances shall function and perform in accordance with the drain, vent, water supply and backflow protection requirements of ch. Comm 82.

History: Cr. Register, May, 1988, No. 389, eff. 6-1-88; renum. from s. Comm 84.14, Register, July, 2000, No. 535, eff. 9-1-00; CR 02-002; am. Register April 2003 No. 568, eff. 5-1-03.

Comm 84.20 Plumbing fixtures, appliances and equipment. (1) DESIGN AND CONSTRUCTION. All plumbing fixtures, appliances and equipment shall be designed and constructed to:

- (a) Ensure durability, proper service and sanitation;
- (b) Be free from defects;
- (c) Be free from concealed fouling surfaces;
- (d) Not require undue efforts in cleaning and operating; and
- (e) Prevent nonpotable liquids, solids or gasses from being introduced into a potable water supply system through cross-connections.

(2) MATERIALS. (a) Plumbing fixtures shall have smooth surfaces that are impervious to water.

(b) All plumbing fixture fittings which are end-point devices, covered by the scope of NSF 61, section 9 and installed to supply water intended for human ingestion, shall conform to NSF 61, section 9.

Note: The scope of NSF 61, section 9 defines which devices are intended for use for human ingestion in response to the Federal clean drinking water act.

(3) WATER CONSERVING FAUCETS, SPOUTS AND PLUMBING FIXTURES. Water conserving faucets, spouts and plumbing fixtures which meet or exceed the water conservation requirements established in par. (b) shall be installed as specified in par. (a).

(a) 1. All lavatory faucets, shower heads, urinals, urinal flushing devices, water closets and water closet flushing devices shall conform to par. (b).

2. All faucets installed on kitchen sinks of dwelling units and living units shall conform to par. (b) 4.

(b) 1. 'General.' Flow control or flow restricting devices shall be installed on the water inlet side or shall be an integral part of the faucet, spout or fixture. A flow controlling or restricting aerator shall be considered to be an integral part of a faucet or spout.

2. 'Lavatory faucet.' a. The maximum discharge rate of lavatory faucets shall be 2.2 U.S. gallons per minute at a 60 psig flowing supply pressure.

b. Lavatory faucets that are of the metering type shall allow a maximum of 0.25 U.S. gallon per metering cycle at an 80 psig flowing supply pressure.

3. 'Shower heads.' The maximum discharge rate of shower heads shall be 2.5 U.S. gallons per minute at an 80 psig flowing supply pressure.

4. 'Sink faucets.' The maximum discharge rate of sink faucets shall be 2.2 U.S. gallons per minute at 80 psig flowing supply pressure.

5. 'Urinals.' Urinals shall function properly with a maximum of one U.S. gallon per flush at an 80 psig flowing supply pressure.

6. 'Urinal flushing devices.' The flushing cycle for urinal flushing devices shall discharge a maximum of one U.S. gallon per flush per fixture use at static test pressure of 20 psig and 80 psig.

7. 'Water closets.' Water closets shall function properly with a maximum of 1.6 U.S. gallons per flush over the range of static test pressure specified in Table 84.20.

8. 'Water closet flushing devices.' The flushing cycle for water closet flushing devices shall discharge a maximum of 1.6 U.S. gallons over the range of static test pressures specified in Table 84.20.

**Table 84.20
STATIC TEST PRESSURES FOR WATER CLOSETS
AND WATER CLOSET FLUSHING DEVICES**

Tank Type	Flushometer Type	
	Siphonic	Blow Out
20 to 80 psig	25 to 80 psig	35 to 80 psig

(4) GENERAL REQUIREMENTS. (a) *Fixture outlets.* 1. The outlet passageway of a fixture shall be free from impairments and of sufficient size to insure proper discharge of the fixture contents under normal conditions.

2. The outlet connection of a fixture which directly connects to the drain system shall be an air and watertight joint.

(b) *Installation of fixtures.* 1. 'Access for cleaning.' Plumbing fixtures shall be so installed as to afford easy access for cleaning both the fixture and the area around it.

2. 'Securing wall mounted fixtures.' Wall mounted fixtures shall be rigidly supported by a hanger which is attached to structural members so that the load is not transmitted to the fixture drain connection or any other part of the plumbing system. The hanger for a wall mounted water closet shall conform to ASME A112.6.1M.

3. 'Water supply protection.' The water supply pipes and fittings within every plumbing fixture shall be so installed as to prevent backflow.

4. 'Design of overflow.' A fixture which is provided with an overflow outlet shall be designed and installed so that standing water in the fixture cannot rise in the overflow when the fixture's

stopper is closed, and so that no water remains in the overflow when the fixture is empty.

5. 'Connection of overflows.' The overflow from any fixture shall discharge into the drain system on the inlet or fixture side of the trap.

6. 'Overflows in flush tanks.' Flush tanks shall be provided with overflows discharging to the fixture served and shall be of sufficient size to prevent flooding the tank at the maximum rate at which the tanks are supplied with water.

7. 'Strainers.' All plumbing fixtures other than water closets, clinic sinks, trap standard service sinks with flush rims, urinals, standpipes and waste sinks shall be provided with strainers, cross bars or pop-up stoppers which restrict the clear opening of the waste outlet.

8. 'Flushometer valves.' Flushometer valves shall be equipped with vacuum breakers which conform to ASSE 1001. Flushometer valves may not be used where the water pressure is insufficient to properly operate them. When the valve is operated, it shall complete the cycle of operation automatically, opening fully and closing positively under the water supply pressure. Each flushometer shall be provided with a means for regulating the flow through it.

9. 'Safing.' a. The floor of all site-constructed shower stalls and shower rooms shall be protected with a safing material installed beneath the finished floor of the entire enclosure or room and upward along the sides to a minimum of 6 inches above the curb or maximum water level of the room or enclosure. The corners of the enclosure or room shall be safed to a height of 6 feet and at least 3 inches in each direction from the corners.

b. All floor drains or other similar fixtures shall be installed with a safing material extending a minimum of 12 inches from the fixture.

c. The safing material shall conform to s. Comm 84.30 (6).

d. The safing material shall be properly drained.

e. All installations directly over an unexcavated portion of a building are exempt from this subdivision.

Note: Chapters Comm 61 to 65 and 90 contain provisions for toilet rooms and sanitary facilities for public buildings and places of employment, including provisions concerning toilet facilities for people with disabilities, fixture compartments, number of fixtures for the different types of occupancies, and toilet room finishes.

(5) PLUMBING FIXTURES AND PLUMBING APPLIANCES. (a) *Automatic clothes washers.* Residential type automatic clothes washers shall conform to ASSE 1007.

(b) *Bathtubs.* 1. a. Enameled cast iron bathtubs shall conform to ASME A112.19.1M.

b. Porcelain enameled formed steel bathtubs shall conform to ASME A112.19.4.

c. Plastic bathtubs shall conform to ANSI Z124.1.2.

2. Bathtubs shall have waste outlets and overflows at least 1-1/2 inches in diameter. A closing device shall be provided on the waste outlet.

3. All whirlpool piping for bathtubs shall drain by gravity to the trap serving the bathtub.

4. All waterways of the whirlpool pump for a bathtub shall drain by gravity to the trap serving the bathtub.

(c) *Bidets.* Vitreous china bidets shall conform to the material requirements in ASME A112.19.2M.

1. A bidet may not be located closer than 15 inches from its center to any side wall, partition, vanity or other obstruction, nor closer than 30 inches center to center from a water closet.

2. Bidets with submerged inlet fittings shall be protected by vacuum breakers which conform to ASSE 1001 or CAN/CSA B64.1.1.

(d) *Chemical dispensing systems.* Chemical dispensing systems shall conform to ASSE 1055.

(e) *Dishwashing machines.* 1. Residential type dishwashing machines shall conform to ASSE 1006.

2. Commercial type dishwashing machines shall conform to ASSE 1004.

(f) *Drinking fountains.* 1. Drinking fountains and water coolers shall conform to ARI 1010 or ASME A112.19.2M.

2. Drinking fountains may not be installed in toilet rooms.

3. The water supply for drinking fountains shall be provided with an adjustable valve fitted with a loose key or an automatic self-closing valve permitting regulation of the rate of flow of water. The water supply issuing from the nozzle shall be of sufficient volume and height so that persons using the fountain need not come in direct contact with the nozzle or orifice.

4. A drinking fountain may not have a waste outlet less than 1-1/4 inches in diameter.

(g) *Floor drains.* 1. Floor drains shall be provided with removable strainers of sufficient strength to carry the anticipated loads.

2. The floor drain shall be so constructed that it can be cleaned, and the drain inlet shall be accessible at all times.

3. Floor drains shall be of a size to efficiently serve the intended purpose. The floor drain outlet shall not be less than 2 inches in diameter.

(h) *Food waste grinders.* 1. Residential type food waste grinders shall conform to ASSE 1008. Commercial type food waste grinders shall conform to ASSE 1009.

2. Food waste grinders shall be connected to a drain of sufficient size to serve the unit, but not less than 1 1/2 inches in diameter.

3. All food waste grinders shall be provided with an adequate supply of cold water at a sufficient flow rate to insure proper functioning of the unit.

(i) *Laundry trays.* Each compartment of a laundry tray shall be provided with a waste outlet not less than 1 1/2 inches in diameter.

(j) *Lavatories.* 1. a. Enameled cast iron lavatories shall conform to ASME A112.19.1M.

b. Vitreous china lavatories shall conform to ASME A112.19.2M.

c. Stainless steel lavatories shall conform to ASME A112.19.3.

d. Porcelain enameled formed steel lavatories shall conform to ASME A112.19.4.

e. Plastic lavatories shall conform to ANSI Z124.3.

2. Cultured marble vanity tops with an integral lavatory shall conform to ANSI Z124.3.

3. Lavatories shall have waste outlets not less than 1 1/4 inches in diameter.

(k) *POWTS design packages and POWTS components.* POWTS design packages and POWTS components shall function and perform in accordance with assertions submitted to and approved by the department under s. Comm 84.10.

(L) *Showers.* 1. Prefabricated plastic showers and shower compartments shall conform to ANSI Z124.2.

2. Except for combination bathtub-shower units, waste outlets serving showers shall be at least 2 inches in diameter and shall have removable strainers of sufficient strength for the anticipated loads.

3. Where a waste outlet serves more than one shower space or shower head, the waste outlet shall be at least 2 inches in diameter and the waste outlet shall be so located and the floor so pitched that waste water from one shower does not flow over the floor area serving another shower.

Note: Chapters Comm 61 to 65 specify slip-resistant requirements for shower rooms and compartments in public buildings and places of employment.

4. All shower compartments, regardless of shape, shall have a minimum finished interior of 900 square inches and shall be capable of encompassing a circle with a diameter of 30 inches. The minimum required area and dimension shall be measured in

a horizontal plane 24 inches above the top of the threshold and may not extend beyond the centerline of the threshold. The minimum area and dimensions shall be maintained to a point 70 inches above the shower waste outlet with no protrusions other than the fixture valve or valves, showerheads, soap dishes, retractable seats and safety grab bars or rails.

Note: See Appendix for further explanatory materials.

(m) *Sinks.* 1. a. Enameled cast iron sinks shall conform to ASME A112.19.1M.

b. Vitreous china sinks shall conform to ASME A112.19.2M.

c. Stainless steel sinks shall conform to ASME A112.19.3.

d. Porcelain enameled formed steel sinks shall conform to ASME A112.19.4.

e. Plastic sinks shall conform to ANSI Z124.6.

2. Sinks shall be provided with waste outlets not less than 1 1/2 inches in diameter.

(n) *Urinals.* 1. a. Vitreous china urinals shall conform to ASME A112.19.2M.

b. Plastic urinals shall conform to ANSI Z124.9.

2. A urinal may not be located closer than 15 inches from its center to any side wall, partition, vanity or other obstruction, nor closer than 30 inches center to center, between urinals.

Note: See Appendix for further explanatory material.

3. Stall type urinals shall be set into the floor and the floor shall be pitched toward the fixture.

4. Automatic siphon urinal flush tanks may not be installed.

5. Pressurized flushing devices to serve urinals shall conform to ASSE 1037.

(o) *Water closets.* 1. a. Vitreous china water closets shall conform to ASME A112.19.2M.

b. Plastic water closets shall conform to ANSI Z124.4.

2. Except as permitted in subd. 3., all water closets required to be provided in public buildings and places of employment shall be of an elongated bowl type, and provided with either:

a. Hinged, open-front seats without covers; or

b. Hinged, closed-front seats, without covers, which are encased with a continuous plastic sleeve capable of providing a clean surface for every user.

3. a. Water closets provided in day care centers, individual living units or sleeping units of residential occupancies may be of a round-bowl type with a hinged, closed front seat with or without a cover.

b. Water closets provided in prisons or correctional institutions may be of a round-bowl type, with or without a seat or cover.

4. A water closet may not be located closer than 15 inches from its center to any side wall, partition, vanity, or other obstruction, nor closer than 30 inches center to center, between water closets. There shall be at least 24 inches clearance in front of a water closet to any wall, fixture or door.

Note: See Appendix for further explanatory material.

5. No person may install or maintain pan, plunger, offset washout, washout, long hopper, frostproof and other types of water closets having invisible seals or unventilated spaces or walls not thoroughly cleansed at each flushing.

6. Each water closet shall be individually equipped with a flushing device. Pressurized flushing devices shall conform to ASSE 1037. All flushing devices shall be readily accessible for maintenance and repair. Ballcocks and fill valves shall be of the anti-siphon type and shall conform to ASSE 1002. The critical level mark on the ballcock and fill valve shall be located at least one inch above the full opening of the overflow pipe.

(p) *Water heaters.* 1. Listed equipment. All water heaters shall bear the label of a listing agency acceptable to the department.

Note: See Appendix A-84.11 for listing agencies acceptable to the department.

2. Design. a. All pressurized water heaters and pressurized hot water storage tanks, except those bearing the label of the

American Society of Mechanical Engineers, shall be designed and constructed to withstand a minimum test pressure of 150% of the maximum allowable working pressure of the heater or tank.

b. All pressurized water heaters and pressurized hot water storage tanks shall be rated for a minimum working pressure of 125 psig.

c. A drain valve shall be installed at the lowest point of each water heater and hot water storage tank.

3. Safety devices. a. Relief valves shall be listed by the American Gas Association, Underwriters Laboratories, Inc. or American Society of Mechanical Engineers when the heat input to a water heater is less than or equal to 200,000 Btu per hour.

b. Relief valves shall be listed by the American Society of Mechanical Engineers when the heat input to a water heater exceeds 200,000 Btu per hour.

c. Pressure relief valves shall be set to open at either the maximum allowable working pressure rating of the water heater or storage tank or 150 psig, whichever is smaller.

d. Temperature and pressure relief valves shall be set to open at a maximum of 210° F and in accordance with subd. 3. c.

Note: See s. Comm 82.40 (5) (d) 1. concerning the sizing of temperature and pressure relief valves.

4. Hot water dispensers. Nonpressurized point-of-use water heaters shall conform to ASSE 1023.

(q) *Water meters.* A water meter which is used pursuant to s. Comm 83.54 (2) shall conform to AWWA C700, AWWA C701, AWWA C702, AWWA C704, AWWA C706, AWWA C707, AWWA C708, or AWWA C710.

(r) *Water treatment devices.* 1. Water softeners shall conform to NSF-44.

Note: See s. Comm 82.40 for limitations as to the types of water treatment devices which may discharge to a POWTS.

2. a. Except as provided in subd. 2. b., water treatment devices shall function and perform in accordance with the assertions submitted to the department under s. Comm 84.10, relating to rendering inactive or removing contaminants.

b. A water treatment device which injects a water treatment compound into a water supply system shall maintain the compound concentration in the system over the working flow rate range and pressure range of the device.

3. Except as specified in subd. 4., water treatment compounds introduced into the water supply system by a water treatment device shall be listed as an acceptable drinking water additive by a listing agency approved by the department. Listing agencies approved by the department shall include:

- a. United States environmental protection agency;
- b. United States food and drug administration; and
- c. National sanitation foundation.

4. A water supply system shall be protected from backflow when unlisted water treatment compounds, which may affect the potability of the water, are introduced into the system. The department shall determine the method of backflow protection. Water supply outlets for human use or consumption may not be installed downstream of the introduction of an unlisted water treatment compound.

5. Water treatment devices designed for contaminated water supplies shall be labeled to identify the following information:

- a. The name of the manufacturer of the device;
- b. The device's trade name; and
- c. The device's model number.

(s) *Other plumbing fixtures, appliances and equipment.* Plumbing fixtures, appliances and equipment not specifically covered in this subsection shall conform to the applicable performance standards of this chapter and chs. Comm 82 and 83.

(6) **FAUCETS, SPOUTS AND FIXTURE SUPPLY CONNECTORS.** (a) Except for circular and semi-circular wash fountains, all faucets

and showerheads shall conform to ASME A112.18.1M or CAN/CSA B125.

(b) Circular and semi-circular wash fountains shall conform to the working pressure, burst pressure, discharge rate and product marking requirements of ASME A112.18.1M or CAN/CSA B125.

(c) 1. Except as provided in subd. 2., all fixture supply connectors shall be designed and constructed to withstand a minimum pressure of 100 psig at 180°F.

2. All fixture supply connectors installed on a cold water supply serving fixtures, appliances and devices that provide ≤1.0 gpm at each outlet shall be designed and constructed to withstand a minimum pressure of 100 psig at 73.4°F.

(d) Flexible hose and spray assemblies for residential sinks shall conform to ASSE 1025.

(e) Hand-held showers shall conform to ASSE 1014.

History: Cr. Register, May, 1988, No. 389, eff. 6-1-88; r. (5) (m) 2. to 5., cr. (5) (m) 2. and 3., renum. (5) (m) 7. and 8. to be (5) (m) 4. and 5., Register, March, 1991, No. 423, eff. 4-1-91; am. (5) (l) 1. and (m) 1. a., Register, April, 1992, No. 436, eff. 5-1-92; renum. (5) (o) and (p) to be (5) (p) and (q), cr. (5) (l) 5., (n) 1. d. and (o), am. (5) (m) 6., (n) 1. b. and c., Register, February, 1994, No. 458, eff. 3-1-94; and emerg. r. (3) (a) 3., eff. 5-12-94; r. (3) (a) 3., Register, October, 1994, No. 466, eff. 11-1-94; correction in (5) (m) 3. made under s. 13.93 (2m) (b) 7., Stats; renum. (5) (j) to (q) to be (5) (k) to (r) and cr. (5) (j), Register, April, 2000, No. 532, eff. 7-1-00; renum. (2) to be (2) (a) and am., (5) (d) to (r) to be (5) (e) to (s) and am. (5) (f), (j) 1. a. to d., (m) 1. and 2., (n) 1. and 2., (o) 1. a., (6) (a) and (b), (r) 1., (5) (L) 2. and renum. 3. to 5. to be 2. to 4.; am. (4) (b) 2., cr. (2) (b), (5) (d), (m) 1. e., (n) 1. b.; r. and recr. (4) (b) 9., Register, December, 2000, No. 540, eff. 1-1-01; CR 01-139: am. (5) (o) 2. b. and 3. Register June 2002 No. 558, eff. 7-1-02; correction in (5) (q) made under s. 13.93 (2m) (b) 7., Stats., Register June 2002 No. 558; CR 02-002: am. (5) (n) 2., r. and recr. (6) (c) Register April 2003 No. 568, eff. 5-1-03; CR 02-129: r. (5) (h) 3., renum. (5) (h) 4. to be 3. Register January 2004 No. 577, eff. 2-1-04; CR 04-035: am. (5) (p) 1. Register November 2004 No. 587, eff. 12-1-04; CR 08-055: am. (3) (b) 2. to 8., (5) (b) 1. c., (n) 1. a., b., (o) 1. a., 2. b. and (p) 2. c., r. and recr. (5) (o) 3. Register February 2009 No. 638, eff. 3-1-09.

Comm 84.25 POWTS holding components or treatment components. (1) **GENERAL.** All POWTS holding components or treatment components shall conform to the requirements of this section.

(2) **WATER TIGHTNESS.** (a) *General.* Tank assemblies, including fittings and access openings, shall be manufactured to be water tight as required under this subsection.

(b) *Concrete tanks.* 1. Where concrete tanks are required to have covers, the tanks shall meet one of the following requirements:

a. Withstand a vacuum of at least 2 inches of mercury for 60 minutes, without loss of pressure.

b. Hold water for one hour, without leakage after the tank has been filled with water to the top of the cover and let stand for 24 hours, then refilled to the top of the cover.

2. Concrete tanks that are not required to have a cover shall hold water for one hour, without leakage after the tank has been filled with water and let stand for 24 hours, then refilled to the highest liquid level required to be held in the tank.

(c) *Steel tanks.* 1. Steel tanks that are required to have a cover shall be capable of withstanding one of the following requirements:

a. An internal air pressure of at least 5 psig for 15 minutes, without loss of pressure.

b. An internal water pressure of at least 5 psig for 60 minutes, without loss of pressure.

2. Steel tanks that are not required to have a cover shall be capable of holding water after being filled to their inlet or outlet, whichever is higher, for 24 hours without loss of water.

(d) *Tanks constructed of materials other than concrete or steel.* 1. Tanks constructed of materials other than concrete or steel that are required to have a cover shall be capable of withstanding one of the following requirements:

a. A vacuum of at least 2 inches of mercury for 60 minutes, without loss of pressure.

b. An internal air pressure of at least 5 psig for 15 minutes, without loss of pressure.

c. An internal water pressure of at least 5 psig for 60 minutes, without loss of pressure.

2. Tanks constructed of materials other than concrete or steel that are not required to have a cover shall be capable of holding water after being filled to their inlet or outlet, whichever is higher, for one hour without loss of water.

(3) **STRENGTH.** Tank assemblies, including fittings and access openings, shall be capable of withstanding loads and pressures that the tanks are intended to encounter and remain watertight.

(4) **PROTECTION FROM ELEMENTS.** (a) *Concrete tanks.* 1. The interior of a concrete tank assembly, including fittings and access openings, shall have a protective coating or be constructed of material, above the lowest liquid level expected in the tank, that will inhibit the deterioration of the concrete due to internal environmental effects.

2. Under subd. 1., concrete with a water cement ratio not exceeding 0.45 shall be considered resistant to deterioration due to internal environmental effects.

(b) *Steel tanks.* 1. Steel tank assemblies, including fittings and access openings, shall have a protective coating that will inhibit the deterioration of the steel due to internal and external environmental effects.

2. Steel tank assemblies, including fittings and access openings, installed underground shall be provided with cathodic protection in accordance with UL Standard 1746 or STI-P₃.

(c) *Tanks constructed of materials other than concrete or steel.* Tank assemblies, including fittings and access openings, constructed of materials other than concrete or steel shall be protected against deterioration due to internal and external environmental effects.

(5) **VENTING.** (a) Each tank, except camping unit transfer containers, shall be provided with a means of venting gases formed inside of the tank to the atmosphere.

(b) The tank vent shall terminate in accordance with s. Comm 82.31 (16).

(6) **PIPE CONNECTION.** All pipe connection openings to a tank shall be designed to allow connections in accordance with s. Comm 84.40.

(7) **ACCESS.** (a) Each covered tank shall be provided with one or more openings of sufficient size and located in such a manner to provide a means for inspection or required servicing or maintenance of the tank.

(b) Manhole openings shall be at least 23 inches in the least dimension.

(c) Anaerobic treatment tanks located below ground shall have a manhole opening over the inlet of the most upstream compartment, in each compartment, and over all treatment apparatuses and pumps.

(d) 1. Except as provided in subd. 2., manhole openings for anaerobic treatment tanks located below ground shall extend to a distance not greater than 6 inches below finished grade.

2. Manhole openings over all anaerobic treatment apparatuses and pumps shall extend to at least 4 inches above finished grade.

(e) Servicing and maintenance openings for holding components shall comply with all of the following:

1. Extend to at least 4 inches above finished grade.

2. Be at least 23 inches in the least dimension and be located above pumps or siphons located in the holding component.

(f) Inspection openings for tanks located below ground shall extend at least to the finished grade.

(g) Inspection, servicing and maintenance openings shall terminate with a means that prevents entrance of deleterious materials.

(h) Covers located at or above ground for openings larger than 8 inches in diameter shall be provided with locking devices or other effective measures to prevent unauthorized access.

(8) **WARNING LABEL.** (a) Covers for all tank openings larger than 8 inches in diameter shall be provided with a permanent warning label indicating the dangers of entering the tank, in accordance with this subsection.

(b) The warning label shall be securely attached and made of a noncorrosive metal or plastic bearing the legend "DO NOT ENTER WITHOUT PROPER EQUIPMENT" or "DANGEROUS GASES EXIST IN TANK" or similar language.

(c) The label shall be rectangular in shape with minimum dimensions of 4 by 5 inches.

(d) The wording on the label shall be a minimum of ½ inch in height and be either indented or raised.

(9) **DOSING APPARATUS.** (a) Pumps for POWTS used to disperse air, treated wastewater or final effluent shall be rated by the pump manufacturer for such use.

(b) Siphons for POWTS shall be rated by the siphon manufacturer for wastewater use.

(c) All other dosing apparatus for POWTS shall be constructed of corrosive resistant materials and designed to perform as intended.

(10) **ALARM SYSTEM.** All pump and alarm controls for POWTS shall be specifically designed by the manufacturer for such use.

(11) **TANK LABEL.** (a) *Anaerobic treatment tanks.* Each treatment tank which has an anaerobic treatment compartment shall be labeled with a permanent label located near an inlet or outlet opening of the tank. The label shall be embossed, impressed, or securely attached to the tank. The label shall include all of the following information:

1. Name or trademark of the manufacturer.

2. Capacity of each compartment of the tank or the manufacturer's model number.

(b) *Aerobic treatment tanks.* 1. Each aerobic treatment tank complying with NSF Standard 40 and listed by a nationally recognized ANSI accredited third party certified listing agency acceptable to the department shall be provided with 2 label plates. The labels shall conform with all of the following:

a. Label plates shall be inscribed to be easily read and understood, and be securely attached.

b. One label plate shall be attached to the front of the electrical control box and the second label plate shall be attached to the aeration equipment assembly, tank, or riser at a location normally subject to access during inspection of the unit.

c. Each label plate shall include name or trademark of the manufacturer, model number, and rated daily flow capacity of the unit.

Note: See appendix section A-84.11 for acceptable listing agencies.

(c) *Other treatment, holding and combination treatment-holding tanks.* Except as required in par. (a) or (b), each treatment tank and holding tank shall be labeled with a permanent label located near an inlet or outlet opening. The label shall be embossed, impressed, or securely attached to the tank. The label shall include all of the following information:

1. Name or trademark of the manufacturer.

2. Capacity of each compartment of the tank or the manufacturer's model number.

(12) **OTHER TREATMENT COMPONENTS.** A treatment component not specifically covered in this section may not be sold for use in a POWTS or may not be installed in a POWTS, unless it has received department approval and conforms to the applicable performance standards of this chapter and chs. Comm 82 and 83, and ch. 145, Stats.

History: Cr. Register, April, 2000, No. 532, eff. 7-1-00; CR 02-129: r. and recr. (7) and (11) Register January 2004 No. 577, eff. 2-1-04; CR 07-100: am. (7) (h), return. (10) (a) to be (10), r. (10) (b) Register September 2008 No. 633, eff. 10-1-08.

Comm 84.30 Plumbing materials. (1) **GENERAL.** When selecting the material and determining size for a plumbing

system, due consideration shall be given to the waste that will discharge to the plumbing system and to the soil, liquid and atmospheric environments where the plumbing system will be located.

(a) The bending or offsetting of flexible or annealed pipe or tubing shall be in accordance with the applicable material standard or the instructions of the manufacturer of the pipe or tubing.

(b) Pipe or tubing with gouges, cuts or deep scratches may not be installed.

(c) Pipe or tubing which has been kinked may not be installed.

(d) The bending or offsetting of rigid pipe shall be prohibited.

(e) Nailing plates shall be installed to protect copper or plastic pipe or tubing from puncture.

(f) Pipe and tubing for water distribution systems downstream of treatment devices designed to serve fixtures, appliances and devices that provide ≤ 1 gpm at each outlet shall be sleeved when penetrating a wall, floor or structural member.

(2) **SANITARY DRAIN AND VENT SYSTEMS AND POWTS INSPECTION AND OBSERVATION PIPING.** Sanitary drain systems and vent systems and POWTS inspection and observation piping shall be of such material and workmanship as set forth in this subsection.

(a) *Above ground drain and vent pipe.* Except as provided in s. Comm 82.33 (2), drain pipe and vent pipe installed above ground shall conform to one of the standards listed in Table 84.30-1.

(b) *Underground drain and vent pipe.* Except as provided in par. (d), drain pipe and vent pipe installed underground shall conform to one of the standards listed in Table 84.30-2.

(c) *Sanitary building sewer pipe.* Sanitary building sewer pipe shall conform to one of the standards listed in Table 84.30-3.

(d) *Treated wastewater piping.* 1. Nonpressurized, nonperforated drain piping conveying treated wastewater from a POWTS treatment or holding component to a POWTS treatment or holding component, distribution cell or dispersal zone shall conform to one of the standards listed in Table 84.30-3.

2. Nonpressurized perforated drain piping conveying treated wastewater in a POWTS soil treatment or dispersal component shall conform to one of the standards listed in Table 84.30-4.

3. Pressurized perforated drain piping conveying treated wastewater in a POWTS treatment or dispersal component shall conform to one of the standards listed in Table 84.30-5 and shall be perforated in accordance with the POWTS design.

(e) *Pressurized drain pipe.* Except as provided in par. (d) 3., pressurized drain pipe shall conform to one of the standards listed in Table 84.30-5 and shall be rated for the working pressure and temperature to which it will be subjected for a specific installation.

(f) *Chemical drain and vent pipe.* Drain systems and vent systems for chemical wastes shall be of approved corrosion resistant material. The manufacturer of the pipe shall indicate to the department the material's suitability for the concentrations of chemicals involved.

(g) *Catch basins, interceptors and sumps.* Catch basins, interceptors and sumps shall be constructed in a watertight manner of precast reinforced concrete, reinforced monolithic concrete, cast iron, coated 12-gauge steel, vitrified clay, fiberglass, plastic or other approved materials.

(h) *Manholes.* Manholes shall be constructed in a watertight manner of precast reinforced concrete, reinforced monolithic concrete, brick or block, fiberglass or other approved materials. Fiberglass manholes may be approved for use in traffic areas if the top section of the manhole is not made of fiberglass.

(i) *Service suction lines.* A service suction line or pump discharge line serving a holding tank for cleaning purposes shall conform to one of the standards listed in Table 84.30-5. Joints and connections for suction lines shall conform to s. Comm 84.40. The

use of mechanical joints shall be in accordance with the recommendations and instructions specified by the manufacturer.

(j) *POWTS inspection and observation pipe.* A POWTS inspection and observation pipe shall conform to at least one of the standards listed in Table 84.30-1.

**Table 84.30-1
ABOVE GROUND DRAIN AND VENT PIPE
AND TUBING**

Material	Standard
Acrylonitrile butadiene styrene (ABS)	ASTM D1527; ASTM D2661; ASTM F628
Brass	ASTM B43
Cast iron	ASTM A74; ASTM A888; CISPI 301
Copper	ASTM B42; ASTM B88; ASTM B306
Galvanized steel	ASTM A53
Polyvinyl chloride (PVC)	ASTM D2665; ASTM D1785; ASTM F891 ^b
Synthetic rubber hose ^a	AHAM DW-1

Note a: The installation of synthetic rubber hose is limited in use to indirect waste piping or local waste piping from dishwashers in accordance with s. Comm 82.33 (9) (d).

Note b: Limited to pipe weight of schedule 40.

**Table 84.30-2
UNDERGROUND DRAIN AND VENT PIPE
AND TUBING**

Material	Standard
Acrylonitrile butadiene styrene (ABS)	ASTM D1527; ASTM D2661; ASTM F628
Cast iron	ASTM A74; ASTM A888; CISPI 301
Copper ^a	ASTM B42; ASTM B88
Polyvinyl chloride (PVC)	ASTM D1785; ASTM D2665; ASTM D3034 ^b ; ASTM F891 ^c

Note a: Copper tubing, type M, may not be installed underground.

Note b: Limited to pipe with a SDR of 26 or less.

Note c: Limited to pipe weight of schedule 40.

**Table 84.30-3
SANITARY BUILDING SEWER PIPE AND TUBING**

Material	Standard
Acrylonitrile butadiene styrene (ABS) ^a	ASTMD1527; ASTM D2661; ASTM D2751; ASTM F628
Acrylonitrile butadiene styrene (ABS) composite ^a	ASTM D2680
Cast iron	ASTM A74; ASTM A888; CISPI 301
Concrete	ASTM C14; ASTM C76
Copper ^b	ASTM B42; ASTM B88
Polyvinyl chloride (PVC) ^a	ASTM D1785; ASTM D2665; ASTM D3034; ASTM F891
PVC Corrugated Sewer Pipe With a Smooth Interior and Fittings	ASTM F949
PVC Large-Diameter Plastic Gravity Sewer Pipe and Fittings	ASTM F679

Table 84.30-3 (Continued)
SANITARY BUILDING SEWER PIPE AND TUBING

Material	Standard
PVC Profile Gravity Sewer Pipe and Fittings Based on Controlled Inside Diameter	ASTM F794
Type PS-46 and Type PS-115 PVC Plastic Gravity Flow Sewer Pipe and Fittings	ASTM F789

^aThermoplastic sewer pipe shall be installed in accordance with ASTM D2321.

^bCopper tubing, type M, may not be installed underground.

Table 84.30-4
PERFORATED EFFLUENT DISTRIBUTION PIPING FOR NONPRESSURIZED SOIL ABSORPTION SYSTEMS

Material	Standard
Polyethylene (PE) ^a	ASTM F405; ASTM F810
Polyvinyl chloride (PVC) ^a	ASTM D2729

Note a: The pipe shall have 2 rows, and only 2 rows, of perforations parallel to the axis of the pipe and $120^\circ \pm 5^\circ$ apart. The perforations shall be at the nominal 4 and 8 o'clock positions when the pipe is installed.

Table 84.30-5
PRESSURIZED DRAIN PIPE AND TUBING AND SERVICE SUCTION LINES

Material	Standard
Acrylonitrile butadiene styrene (ABS) ^a	ASTM D1527; ASTM D2282; ASTM D2661; ASTM F628
Brass	ASTM B43
Chlorinated Poly (Vinyl Chloride) (CPVC) ^a	ASTM D2846; ASTM F441/F441M; ASTM F442/F442M
Concrete	ASTM C14; ASTM C76
Copper ^b	ASTM B42; ASTM B88; ASTM B306
Ductile iron	AWWA C115; AWWA C151
Galvanized steel	ASTM A53
Polyethylene Pressure Pipe and Fitting, 4 in. through 63 in., for Water Distribution	AWWA C906
Polyethylene (PE) Pressure Pipe and Tubing, 1/2 in. through 3 in.	AWWA C901-02
Polyvinyl chloride (PVC) ^a	ASTM D1785; ASTM D2241; ASTM D2665; AWWA C900
Stainless Steel	ANSI B36.19M; ASTM A269; A312/A312M; ASTM A450; A778; AWWA C220

^aThermoplastic sewer pipe shall be installed in accordance with ASTM D2321.

^bCopper tubing, type M, may not be installed underground.

(3) **STORM AND CLEAR WATER DRAIN AND VENT SYSTEMS.** Storm and clear water drain and vent systems shall be of such material and workmanship as set forth in this subsection.

(a) *Above ground drain and vent pipe.* Drain pipe and vent pipe installed above ground and inside a building shall conform to one of the standards listed in Table 84.30-1, except black steel pipe conforming to ASTM A53 may be used for storm water con-

ductors. Black steel conductors may not be embedded in concrete or masonry.

(b) *Underground drain and vent pipe.* Drain pipe and vent pipe installed underground shall conform to one of the standards listed in Table 84.30-2.

(c) *Storm building sewer pipe.* Storm building sewer pipe shall conform to one of the standards listed in Table 84.30-6.

(d) *Subsoil drain pipe.* Subsoil drains shall be open jointed, horizontally split, or perforated pipe conforming to one of the standards listed in Table 84.30-7.

(e) *Roof drains.* 1. Roof drains shall be provided with removable strainers of sufficient strength to carry the anticipated loads.

2. Roof drains shall be so constructed that the drains can be cleaned and the drain inlets accessible at all time.

3. Roof drains shall be sized in accordance with s. Comm 82.36 and the drain outlet shall not be less than $2\frac{1}{2}$ inches in diameter.

Note: See s. Comm 82.36 (18) for additional roof drain requirements.

(f) *Area drain inlets.* Area drain inlets shall be constructed in a watertight manner of precast concrete, reinforced monolithic concrete, brick or block, cast iron, coated 12 gauge steel, vitrified clay, fiberglass or other approved materials.

Table 84.30-6
STORM BUILDING SEWER PIPE AND TUBING

Material	Standard
Acrylonitrile butadiene styrene (ABS) ^a	ASTM D1527; ASTM D2661; ASTM D2751; ASTM F628
Acrylonitrile butadiene styrene (ABS) composite ^a	ASTM D2680
Cast iron	ASTM A74; ASTM A888; CISPI 301
Concrete, circular	ASTM C14; ASTM C76
Concrete, elliptical	ASTM C507/C507M
Copper ^b	ASTM B42; ASTM B88
Polyvinyl chloride (PVC) ^a	ASTM D1785; ASTM D2665; ASTM D3034; ASTM F891
PVC Corrugated Sewer Pipe With a Smooth Interior and Fittings	ASTM F949
PVC Large-Diameter Plastic Gravity Sewer Pipe and Fittings	ASTM F679
PVC Profile Gravity Sewer Pipe and Fittings Based on Controlled Inside Diameter	ASTM F794
Type PS-46 and Type PS-115 PVC Plastic Gravity Flow Sewer Pipe and Fittings	ASTM F789

^aThermoplastic sewer pipe shall be installed in accordance with ASTM D2321.

^bCopper tubing, type M, may not be installed underground.

(4) **WATER SUPPLY SYSTEMS.** Water supply systems shall be of such material and workmanship as set forth in this subsection. All materials in contact with water, in a water supply system, shall be suitable for use with potable water. All pipes and pipe fittings for water supply systems shall be made of a material that contains not more than 8.0% lead.

(a) *Water quality.* A water supply system shall be resistive to corrosive action and degrading action from the water being conveyed.

(b) *Soil and groundwater.* The installation of water supply systems shall be prohibited in soil and groundwater that is contami-

nated with solvents, fuels, organic compounds or other detrimental materials which will cause permeation, corrosion, degradation, or structural failure of the piping material.

1. Where detrimental conditions are suspected, a chemical analysis of the soil and groundwater conditions shall be required to ascertain the acceptability of the proposed water supply system materials for the specific installation.

2. Where a detrimental condition exists, no underground water supply system may be installed until the detrimental condition can be:

a. Eliminated and the source of the condition can be eliminated;

b. Identified and the pipe and joining method can be proven resistant to the detrimental condition; or

c. Avoided by choosing an alternate route that will not be affected by the detrimental condition.

(c) *Certification of plastic pipe.* Plastic pipe for a water supply system shall be certified for potable water contact by a nationally recognized listing agency acceptable to the department.

Note: For a listing of nationally recognized agencies acceptable to the department, see Appendix A-84.11.

(d) *Water services and private water mains.* 1. Water service pipe and private water mains shall conform to one of the standards listed in Table 84.30-7. Pipe and tubing for water services and private water mains shall have a minimum working pressure of 150 psig at 73.4°F.

2. A local governmental unit may by ordinance restrict the types of materials for water services and private water mains which are to be located within or beneath an area subject to an easement for a highway, street or public service right-of-way. Before adopting an ordinance restricting the types of materials for water services, the local governmental unit shall submit a copy of the proposed ordinance to the department for review and approval.

3. Materials for combination water services and combination private water mains shall comply with NFPA 24 and the provisions specified in par. (d).

(e) *Water distribution pipe.* 1. Except as provided in subd. 2. or 3., water distribution pipe shall have a minimum working pressure of 100 psig at 180°F and shall conform to one of the standards listed in Table 84.30-8

2. Cold water distribution pipe installed underground shall have a minimum working pressure of 150 psig at 73.4°F and shall conform to one of the standards listed in Table 84.30-7 or 84.30-8.

Note: Portions of a water supply system that supply water to a water-based fire protection system are to also conform to chs. Comm 61 to 65.

Note: See appendix for further explanation.

3. Pipe and tubing for cold water distribution systems downstream of water treatment devices designed to serve fixtures, appliances and devices that provide ≤ 1 gpm at each outlet shall conform to one of the standards listed in Table 84.30-8 or 84.30-11, and shall have a minimum working pressure of 100 psig at 73.4°F.

4. Plastic pipe and tubing for water distribution systems downstream of water treatment devices designed to serve fixtures, appliances and devices that provide ≤ 1 gpm at each outlet shall be marked at intervals not to exceed 4 feet with the following information:

- The manufacturer's name.
- The trade designation of the pipe or tubing.
- The type of material.
- The minimum working temperature and pressure of the pipe or tubing.
- The mark of the certifying agency.

**Table 84.30-7
PIPE AND TUBING FOR
WATER SERVICES AND PRIVATE WATER MAINS**

Material	Standard
Acrylonitrile butadiene styrene (ABS) ^a	ASTM D1527; ASTM D2282
Brass	ASTM B43
Chlorinated Poly (Vinyl Chloride) (CPVC) ^a	ASTM D2846; ASTM F441/F441M; ASTM F442/F442M
Copper ^{b,c}	ASTM B42; ASTM B88
Crosslinked Polyethylene/Aluminum/Crosslinked Polyethylene	CAN/CSA B137.10, ASTM F1281
Crosslinked polyethylene (PEX) ^a	ASTM F876; ASTM F877
Ductile iron	AWWA C115; AWWA C151
Galvanized steel	ASTM A53
Polyethylene (PE) ^a	AWWA C901-02
Polyethylene/Aluminum/Polyethylene	CAN/CSA B137.9
Polyethylene/Aluminum/Polyethylene (PE-AL-PE) Composite Pressure Pipe	ASTM F1282
Polyvinyl chloride (PVC) ^a	ASTM D1785; ASTM D2241; AWWA C900
Stainless steel	ASME B36.19/B36.19M

^aPlastic water service systems shall be installed in accordance with ASTM D2774.

^bCopper tubing, type M, may not be installed underground.

^cCopper pipe or tubing shall not be installed if the pH of the water to be conveyed is 6.5 or less.

**Table 84.30-8
WATER DISTRIBUTION PIPE AND TUBING**

Material	Standard
Brass	ASTM B43
Cast iron	AWWA C115
Chlorinated Poly (Vinyl Chloride) (CPVC) ^a	ASTM D2846; ASTM F441/441C; ASTM F442/442M ^d
Copper ^{b,e}	ASTM B42; ASTM B88
Crosslinked Polyethylene/Aluminum/Crosslinked Polyethylene	CAN/CSA B137.10, ASTM F1281
Crosslinked polyethylene (PEX) ^a	ASTM F876; ASTM F877
Ductile iron	AWWA C115; AWWA C151
Galvanized steel	ASTM A53
Polyethylene/Aluminum/Polyethylene	CAN/CSA B137.9
Polyethylene/Aluminum/Polyethylene (PE-AL-PE) Composite Pressure Pipe	ASTM F1282
Stainless Steel	ASME B36.19M; ASTM A270; ASTM A450

^aPlastic pipe and tubing installed underground shall be in accordance with ASTM D2774.

^bCopper tubing, type M, may not be installed underground.

^cUse is limited to pipe 2 1/2 inches or less in diameter.

^dUse is limited to pipe with a SDR 11 or less.

^eCopper pipe or tubing shall not be installed if the pH of the water to be conveyed is 6.5 or less.

Table 84.30-9
MINIMUM BENDING RADIUS OF POLYBUTYLENE
WATER DISTRIBUTION PIPE AND TUBING

Pipe Size (inches)	Bending Radius (inches)	Tubing Size (inches)	Bending Radius (inches)
3/4	12 ³ / ₄	1/4	4 ¹ / ₂
1	15 ³ / ₄	3/8	6
1 ¹ / ₄	20	1/2	7 ¹ / ₂
1 ¹ / ₂	23	3/4	10 ¹ / ₂
2	28 ¹ / ₂	1	13 ¹ / ₂
		1 ¹ / ₄	16 ¹ / ₂
		1 ¹ / ₂	19 ¹ / ₂
		2	25 ¹ / ₂

^aPlastic pipe and tubing installed underground shall be in accordance with ASTM D2774.

^bCopper tubing, type M, may not be installed underground.

(f) *Used piping.* Piping which has been used for any other purpose than conveying potable water may not be used for water supply systems.

(5) **PIPE FITTINGS AND VALVES.** (a) *Fittings.* Pipe fittings shall conform to the pipe material standards listed in this chapter or one of the standards listed in Table 84.30-10. Threaded drain pipe fittings shall be of the recessed drainage type.

(b) *Water supply valves.* 1. Control valves for water services and private water mains shall be designed and constructed to withstand a minimum pressure of 125 psig at 73.4°F.

2. Control valves for water distribution systems shall be designed and constructed to withstand a minimum pressure of 100 psig at 180°F.

3. Except for a valve integral to a device, a control valve which serves 2 or more plumbing fixtures shall have, with the valve in a fully open position, a flow through passageway of not less than one nominal pipe size smaller than the nominal size of the piping connecting to the valve.

4. A control valve which serves 2 or more plumbing fixtures may not be a globe type valve.

(c) *Special fittings and valves.* 1. Water hammer arrestors shall conform to ASME A112.26.1 or ASSE 1010.

2. Relief valves and automatic gas shutoff devices for hot water supply systems shall conform to ANSI Z21.22.

3. Backwater valves shall conform to ASME A112.14.1, CAN/CSA B181.1 or CAN/CSA B181.2.

4. Pipe applied atmospheric type vacuum breakers shall conform to ASSE 1001, and CAN/CSA B64.1.1.

5. Water pressure reducing valves and strainers for water pressure reducing valves for domestic water supply systems shall conform to ASSE 1003.

6. Hose connection vacuum breakers shall conform to ASSE 1011 or CAN/CSA B64.2.

7. Backflow preventers with intermediate atmospheric vent shall conform to ASSE 1012 and dual check type atmospheric port backflow preventers shall conform to CAN/CSA B64.3.

8. Reduced pressure backflow preventers and reduced pressure fire protection principle backflow preventers, or backflow preventers, reduced pressure principle type (RP) shall conform with ASSE 1013 or CAN/CSA B64.4.

Note: Reduced pressure backflow preventers and reduced pressure detector fire protection backflow preventers are not permitted for cross connection control.

9. Double check backflow prevention assemblies shall conform to ASSE 1015 or CAN/CSA B64.5.

Note: Double check fire protection backflow preventer assemblies are not permitted for cross connection control.

10. Individual thermostatic, pressure balancing, and combination pressure balancing and thermostatic control valves serv-

ing individual showers shall conform to ASSE 1016 or CAN/CSA B125.

11. Trap seal primer valves, water fed shall conform to ASSE 1018.

12. Vacuum breaker wall hydrants, freeze resistant automatic draining type shall conform to ASSE 1019, types A or B.

13. Pressure vacuum breaker assemblies shall conform to ASSE 1020 or CAN/CSA B64.1.2.

14. Laboratory faucet backflow preventers shall conform to ASSE 1035 and laboratory faucet type vacuum breakers shall conform to CAN/CSA B64.7.

15. Reduced pressure detector fire protection, backflow prevention assemblies shall conform to ASSE 1047.

16. Double check detector assembly backflow preventers shall conform to ASSE 1048.

17. Back siphonage backflow vacuum breakers shall conform to ASSE 1056.

18. Hose connection backflow preventers shall conform to ASSE 1052.

19. Backflow preventers for carbonated beverage machines shall conform to ASSE 1022.

20. Dual check backflow preventers in freeze resistant types of wall hydrants shall conform to ASSE 1053.

(d) *Pipe saddles.* Pipe saddles shall be installed in accordance with the instructions of the saddle manufacturer and conform to all of the following limitations:

1. Pipe saddles may be installed on private interceptor main sewers, building sewers, underground drain and vent pipe and tubing, and where otherwise approved by the department.

2. A saddle for drain piping shall have a radius in accordance with s. Comm 82.30 (8) (a).

3. The material of the saddle shall be compatible with the materials of the pipes which are to be connected to the saddle.

4. The hole in the pipe which is to receive the saddle shall be drilled or cored to match the saddle outlet.

5. Straps or clamps which wrap around the pipe and saddle shall be provided by the manufacturer of the saddle.

6. Saddles shall be installed with straps or clamps which wrap around the pipe and saddle.

7. Proper hangers or bedding shall be provided to maintain alignment between the opening in the pipe and the saddle.

Table 84.30-10
PIPE FITTINGS

Material	Standard
Acrylonitrile butadiene styrene (ABS)	ASTM D2468; ASTM D3311; ASTM F409
Cast bronze	ANSI B16.15; ANSI B16.24
Cast copper alloy	ASME B16.18; ASME B16.23; ASME B16.26
Cast iron	ASME B16.4; ASME B16.12; ASME B16.1; ASME B16.45
Chlorinated polyvinyl chloride (CPVC)	ASTM F437; ASTM F438; ASTM F439
Copper	ASME B16.22; ASME B16.29
Crosslinked Polyethylene (PEX)	ASTM F1807
Ductile iron and gray iron	AWWA C110; AWWA C153; ANSI B16.42
Malleable iron	ANSI B16.3
Polyethylene (PE)	ASTM D2609; ASTM D2683; ASTM D3261

Table 84.30-10 (Continued)
PIPE FITTINGS

Material	Standard
Polyvinyl Chloride (PVC)	ASTM D2464; ASTM D2466; ASTM D2467; ASTM D3311; ASTM F409; ASTM F1336; ASTM F1866
Polyvinyl Chloride (PVC) Gasketed Sewer Fittings	ASTM F1336
Stainless steel	ASTM A403
Steel ^a	ANSI B16.5; ANSI B16.9; ANSI B16.11; ANSI B16.28
Styrene-rubber (SR)	ASTM D2852

^a Steel fittings and malleable iron fittings to be used in a water supply system shall be galvanized-coated in accordance with ASTM A123/123M.

^b See s. Comm 84.30 (4) (intro.) concerning the maximum lead content for fittings.

^c Copper and copper alloy fittings conforming to MSS SP-103, may not be installed underground.

Table 84.30-11
PIPE AND TUBING FOR WATER DISTRIBUTION
SYSTEMS DOWNSTREAM OF TREATMENT
DEVICES DESIGNED TO SERVE FIXTURES,
APPLIANCES AND DEVICES THAT PROVIDE
≤1 GPM AT EACH OUTLET

Material	Standard
Copper ^{b,c}	ASTM B42; ASTM B88
Polyethylene (PE) ^a	NSF 51; NSF 61
Polypropylene (PP) ^a	NSF 51; NSF 61
Polyvinylidene fluoride (PVDF) ^a	NSF 51; NSF 61
Polyvinyl chloride (PVC) ^a	NSF 51; NSF 61

^a These materials are approved for cold water use only.

^b Copper tubing, Type M, shall not be installed underground.

^c Copper pipe or tubing shall not be installed if the pH of the water to be conveyed is 6.5 or less.

(6) **SPECIAL MATERIALS.** (a) *Sheet lead.* Sheet lead for the following uses may not weigh less than indicated in subs. 1. and 2.

1. Site-fabricated flashings for vent pipes, 3 pounds per square foot; and
2. Prefabricated flashings for vent pipes, 2½ pounds per square foot.

(b) *Traps and fixture drain connection fittings.* Copper or tubular brass traps and fixture drain connection fittings shall be at least of 20 gage material.

(c) *Sheet copper.* Sheet copper for the following uses may not weigh less than indicated in subs. 1. and 2. and shall conform to ASTM B152.

1. Flashing for vent pipes, 8 ounces per square foot; and
2. Flush tank linings, 10 ounces per square foot.

(d) *Cleanout plugs.* Cleanout plugs shall be of brass or plastic. Brass cleanout plugs shall be used with metallic piping only and shall conform to ASTM A74. Plastic cleanout plugs shall conform to the requirements of sub. (5) (a).

(e) *Flush pipes and fittings.* Flush pipes and fittings shall be of nonferrous material and shall conform to ASME A112.19.5.

(f) *Safing material.* Safing materials shall be waterproof when subjected to 2 feet of hydrostatic head when tested in accordance with ASTM C1306 or ASTM D4068. The material shall be recognized by the manufacturer for use as a safing material.

(g) *Geotextile fabrics.* Geotextile fabric used in a POWTS to prevent backfill material from entering the distribution cell shall meet the requirements listed in Table 84.30-12.

Table 84.30-12
GEOTEXTILE FABRICS

Property	Test Method	Minimum Average Roll Value
Grab Tensile, lbs	ASTM D4632	35 lbs, minimum
Grab Elongation, %	ASTM D4632	50%, minimum
Puncture, lbs	ASTM D4833	10 lbs, minimum
Trapezoidal tear, lbs	ASTM D4533	11 lbs, minimum
AOS, US Sieve #	ASTM D4751	20 US sieve #, minimum
AOS, US Sieve #	ASTM D4751	70 US sieve #, maximum

(h) *Leaching chambers.* Leaching chambers for distribution cell components of POWTS or stormwater subsurface infiltration systems shall meet all of the following requirements:

1. Constructed of corrosion resistant materials.
2. Designed to prevent soil surrounding the chamber from entering the chamber.
3. Capable of withstanding pressures that the leaching chamber is intended to encounter.

(i) *Stone aggregate.* Stone aggregate which is used as a filtering medium or to create a distribution cell in a treatment or dispersal component of a POWTS or stormwater subsurface infiltration system shall meet all of the following requirements:

1. Conform to ASTM Standard C33 for coarse aggregate prior to washing.
2. Be washed to remove fine material.
3. Be ½ to 2½ inch in size.
4. Have a hardness value of at least 3 on Moh's Scale of Hardness.

Note: Stone that can scratch a copper penny without leaving any residual stone material on the penny has a hardness value of at least 3 on Moh's Scale of Hardness.

(j) *Sand.* Sand that is placed as a filtering medium in a stormwater subsurface infiltration system shall conform to ASTM Standard C33 for fine aggregate.

(k) *Synthetic aggregate.* Synthetic aggregate that is used as a filtering medium or to create a distribution cell in a treatment or dispersal component of a POWTS or stormwater subsurface infiltration system shall meet all of the following requirements:

1. Be made from inert materials.
2. Be ½ inch to 2½ inches in size.
3. Be made of material that will not contaminate groundwater.
4. Be recognized by the manufacturer for use as a filtering media or a material to create a distribution cell.

History: Cr. Register, May, 1988, No. 389, eff. 6-1-88; am. (4) (intro.), Register, August, 1988, No. 392, eff. 9-1-88; renum. (2) (e) to (g) to (f) to (h), cr. (2) (e), am. Table 84.30-4, r. and recr. Table 84.30-5, Register, August, 1991, No. 428, eff. 9-1-91; am. (2) (c), (d) 1. and (e), r. (2) (d) 3., renum. (2) (d) 4. to be (2) (d) 3., cr. (2) (i), Register, April, 1992, No. 436, eff. 5-1-92; am. (3) (a), Tables 1, 3 to 9, 10 and 11, Register, September, 1992, No. 441, eff. 10-1-92; am. Table 84.30-9, cr. (4) (g), Register, September, 1993, No. 453, eff. 10-1-93; am. Tables 84.30-2, 84.30-3, 84.30-6, 84.30-8 and 84.30-9, r. Table 84.30-10a, (6) (a) 1. and (c) 1., cr. (4) (h) and (5) (b) 4., r. and recr. (5) (b) 3., (c) and (6) (f), renum. (6) (a) 2. and 3. and (c) 2. and 3. to be (6) (a) 1. and 2. and (c) 1. and 2., Register, February, 1994, No. 458, eff. 3-1-94; correction in (6) (a) (intro.) made under s. 13.93 (2m) (b) 7, Stats., Register, February, 1994, No. 458; am. Table 84.30-1, (5) (c) 7., 11., 12., 13, 14., cr. (5) (c) 16., 17., Register, February, 1997, No. 494, eff. 3-1-97; am. Tables 84.30-5 and 84.30-9, cr. (6) (g) to (j) and Table 84.30-12 and r. and recr. (2) (d), Register, April, 2000, No. 532, eff. 7-1-00 except Table 84.30-9, eff. 5-1-00; cr. (5) (c) 10., renum. (5) (c) 10. to 17., to be (5) (c) 11. to 18. and am. (5) (c) 1., 3., 4., 6. to 9., am. Tables 84.30-3, 5, 6, 8, 9, 10 and 11; Register, December, 2000, No. 540, eff. 1-1-01; reprinted to correct printing error in Table 84.30-1, Register, April, 2001, No. 544; CR 02-002: r. and recr. (1) (intro.), cr. (1) (f), (2) (j), (4) (i), and Table 84.30-11, am. (2) (intro.), (4) (c) to (e), (f) 2. a., (5) (a), (b) 3., (d) and Tables 84.30-1 to 6, r. Tables 84.30-7 and 10, renum. Tables 84.30-8 to 9m and 11 to be Tables 84.30-7 to 10 and am., Register April 2003 No. 568, eff. 5-1-03; CR 02-129: am. (2) (j) and (4) (e) 2., renum. (4) (d) to be (4) (d) 1., cr. (4) (d) 2. and (4) (e) 4., r. and recr. (4) (e) 3., r. (4) (i) Register January 2004 No. 577, eff. 2-1-04; CR 04-035: cr. (4) (d) 3. and (6) (k), am. (5) (c) 8., (6) (h) (intro.), (i) (intro.) and (j) (intro.) Register November 2004 No. 587, eff. 12-1-04; CR 07-100: am. (6) (j) Register September 2008 No. 633, eff. 10-1-08;

CR 08-055: cr. (5) (c) 20., am. (4) (e) 2., Tables 84.30-2, 84.30-5 to 84.30-8 and 84.30-10, r. (4) (f) and (g), renum. (4) (h) to be (4) (f) Register February 2009 No. 638, eff. 3-1-09.

Comm 84.40 Joints and connections. (1) GENERAL.

(a) *Tightness.* Joints and connections in the plumbing system shall be watertight and gastight as required by test or system design, whichever is greater, or as required by the adopted product standard or department approval.

Note: The testing requirements for tightness are in s. Comm 82.21.

(b) *Preparation of pipe ends.* Pipe ends shall be prepared in accordance with the applicable pipe standard or the pipe or fitting manufacturer's instructions.

(c) *Prohibited joints and connections.* Unless otherwise permitted in this chapter or ch. Comm 82 or 83, all of the following types of joints and connections shall be prohibited:

1. Cement or concrete joints.
2. Mastic or hot poured bituminous joints.
3. Elastomeric rolling o-rings between different diameter pipes.
4. Solvent cement joints between different types of plastic pipe other than ABS and PVC in non-pressurized systems.
5. Roll grooving of galvanized steel pipe.

(2) **ABS PLASTIC PIPE.** Joints between acrylonitrile butadiene styrene plastic pipe or fittings shall be installed in accordance with pars. (a) to (c).

(a) *Mechanical joints.* Mechanical joints shall be installed in accordance with the manufacturer's instructions.

1. 'Drain and vent systems.' Mechanical push-on joints for drain and vent systems shall conform to ASTM D3212.

2. 'Water supply systems.' Mechanical push-on joints and mechanical compression-type joints for water supply systems which use a flexible elastomeric seal shall be suitable for potable water.

(b) *Solvent cemented joints.* Solvent cemented joints shall be made in accordance with ASTM D2235 and its appendix, ASTM D2661 or ASTM F628.

1. Joint surfaces shall be clean and free of moisture.
2. Solvent cement conforming to ASTM D2235 shall be applied to all joint surfaces and the joint shall be made while the cement is wet.
3. Solvent cement shall be handled in accordance with ASTM F402.

4. Solvent cement used on pipes and fittings of a water supply system shall conform to NSF 14 and shall be certified by a nationally recognized testing agency as to conforming to NSF 14. The container for the solvent cement shall bear the certification mark of the testing agency.

(c) *Threaded joints.* Threaded joints shall only be used on pipes of schedule 80 or heavier. Threaded joints shall conform to ASME B1.20.1. The pipe shall be threaded with dies specifically designed for plastic pipe. Thread lubricant or tape approved for such use shall be applied to the male threads only.

(3) **BLACK STEEL PIPE.** Joints between black steel pipe or fittings shall be in accordance with pars. (a) to (d).

(a) *Threaded joints.* Threaded joints shall conform to ASME B1.20.1. Pipe joint compound or tape shall be used on the male threads only.

(b) *Mechanical joints.* Mechanical joints shall be installed in accordance with the manufacturer's instructions.

(c) *Caulked joints.* Caulked joints shall only be used for drain or vent piping. Caulked joints for hub and spigot piping and fittings shall be firmly packed with oakum or hemp. Molten lead shall be poured in one operation not less than one inch deep and not to extend more than 1/8 inch below the rim of the pipe, and caulked tight. Paint, varnish or other coatings may not be used on

the joining material until after the joint has been tested and approved.

1. Caulked joints for drain piping shall be used only in a vertical position.

2. Caulked joints for vent piping may be used for piping in a vertical or horizontal position.

(d) *Welded joints.* Joints between black steel pipe or fittings may be welded.

(4) **BRASS PIPE.** Joints between brass pipe or fittings shall be in accordance with the provisions of pars. (a) to (d).

(a) *Brazed joints.* All joint surfaces to be brazed shall be cleaned bright by other than chemical means. Brazing filler metal conforming to AWS A5.8 or other approved material shall be used. The joining of water supply piping shall be made with lead-free materials. Solders and fluxes containing in excess of 0.2% lead shall not be used.

(b) *Mechanical joints.* Mechanical joints shall be installed in accordance with the manufacturer's instructions. Mechanical push-on joints and mechanical compression type joints for water supply systems which use flexible elastomeric seals shall be suitable for potable water.

(c) *Soldered joints.* All joint surfaces to be soldered shall be cleaned bright by other than chemical means. A nontoxic flux shall be applied to all joint surfaces. Solder conforming to ASTM B32 or other approved material shall be used. The joining of water supply piping shall be made with lead-free materials. Solders and fluxes containing in excess of 0.2% lead shall not be used.

(d) *Threaded joints.* Threaded joints shall conform to ASME B1.20.1. Pipe joint compound or tape shall be used on the male threads only.

(5) **CAST IRON PIPE.** Joints between cast iron pipe or fittings shall be installed in accordance with pars. (a) and (b).

(a) *Caulked joints.* 1. 'Drain and vent systems.' Caulked joints for hub and spigot pipe of drain and vent systems shall be firmly packed with oakum or hemp. Molten lead shall be poured in one operation not less than one inch deep and not to extend more than 1/8 inch below the rim of the pipe, and caulked tight. Paint, varnish or other coatings may not be used on the joining material until after the joint has been tested and approved.

2. 'Water supply systems.' Joints for bell and spigot pipe of water supply systems shall be firmly packed with treated paper rope. Molten lead shall be poured in one operation to a depth of 2 1/2 inches.

(b) *Mechanical joints.* 1. 'Drain and vent systems.' a. Mechanical push-on joints for drain and vent systems shall have gaskets which conform to ASTM C564.

b. Mechanical sleeve joints for drain and vent systems shall have a rubber sealing sleeve conforming to ASTM C564, CISPI 310 or FM 1680. Where a stainless steel band assembly is used, the band assembly shall conform to CISPI 310 or FM 1680. Mechanical joints shall be installed in accordance with the manufacturer's instructions.

2. 'Water supply systems.' Mechanical push-on joints and mechanical compression type joints for water supply systems shall conform to AWWA C111/A21.11. Lead tipped gaskets may not be used.

(c) *Threaded joints.* Threaded joints shall conform to ANSI B1.20.1. Pipe joint compound or tape shall be used on the male threads only.

(6) **CPVC PLASTIC PIPE.** Joints between chlorinated polyvinyl chloride plastic pipe or fittings shall be installed in accordance with the provisions of pars. (a) to (c).

(a) *Mechanical joints.* Mechanical joints shall be installed in accordance with the manufacturer's instructions. Mechanical push-on type joints which use flexible elastomeric seals shall be suitable for potable water.

(b) *Solvent cemented joints.* Solvent cemented joints shall be made in accordance with ASTM D2846 or ASTM F493.

1. Joint surfaces shall be clean and free of moisture. Cleaner, primer and cement shall be installed in accordance with the manufacturer's instructions for use of the solvent cement.

2. Solvent cement conforming to ASTM F493 shall be applied to all joint surfaces and the joint shall be made while the cement is wet.

3. Solvent cement shall be handled in accordance with ASTM F402.

4. Primer and solvent cement used on pipes and fittings of a water supply system shall conform to NSF 14 and shall be certified by a nationally recognized testing agency as to conforming to NSF 14. The containers for the primer and the solvent cement shall bear the certification mark of the testing agency.

(c) *Threaded joints.* Threaded joints shall only be used on pipes of schedule 80 or heavier. Threaded joints shall conform to ANSI B1.20.1. The pipe shall be threaded with dies specifically designed for plastic pipe. Thread lubricant or tape approved for such use shall be applied to the male threads only.

(7) **CONCRETE PIPE.** (a) *Circular pipe.* Joints between circular concrete pipe or fittings shall be made by use of an elastomeric seal conforming to ASTM C443 or C990.

(b) *Elliptical pipe.* Joints between elliptical concrete pipe or fittings shall be made by use of materials conforming to ASTM C887 Type II or ASTM C990.

(8) **COPPER PIPE AND TUBING.** Joints between copper pipe, tubing or fittings shall be installed in accordance with pars. (a) to (e).

(a) *Brazed joints.* All joint surfaces to be brazed shall be cleaned bright by other than chemical means. Brazing filler metal conforming to AWS A5.8 or other approved material shall be used. The joining of water supply piping shall be made with lead-free materials.

(b) *Flared joints.* Flared joints may be used on annealed tubing for water supply systems and shall be made by the use of a tool designed for that operation.

(c) *Mechanical joints.* Mechanical joints shall be installed in accordance with the manufacturer's instructions. Mechanical push-on joints and mechanical compression type joints for water supply systems which use flexible elastomeric seals shall be suitable for potable water.

(d) *Soldered joints.* All joint surfaces to be soldered shall be made in accordance with ASTM B828. Flux approved by NSF for use in potable water systems shall be applied to all joint surfaces. Solder conforming to ASTM B32 or other approved material shall be used. The joining of water supply piping shall be made with lead-free materials.

(e) *Threaded joints.* Threaded joints shall conform to ANSI B1.20.1. Pipe joint compound or tape shall be used on the male threads only.

(9) **DUCTILE IRON PIPE.** (a) *Mechanical joints.* Mechanical push-on joints and mechanical compression type joints for water supply systems shall conform to AWWA C111. Lead tipped gaskets may not be used.

(b) *Threaded joints.* Threaded joints shall conform to ASME B1.20.1. Pipe joint compound or tape shall be used on the male threads only.

(10) **GALVANIZED STEEL PIPE.** Joints between galvanized steel pipe or fittings or between galvanized steel pipe and cast iron fittings shall be installed in accordance with pars. (a) to (c).

(a) *Threaded joints.* Threaded joints shall conform to ASME B1.20.1. Pipe joint compound or tape shall be used on the male threads only.

(b) *Mechanical joints.* Mechanical joints shall be installed in accordance with the manufacturer's instructions. Mechanical push-on joints and mechanical compression type joints for water

supply systems which use flexible elastomeric seals shall be suitable for potable water.

(c) *Caulked joints.* Caulked joints shall only be used for drain or vent piping. Caulked joints for hub and spigot piping and fittings shall be firmly packed with oakum or hemp. Molten lead shall be poured in one operation not less than one inch deep and not to extend more than $\frac{1}{8}$ inch below the rim of the pipe, and caulked tight. Paint, varnish or other coatings may not be used on the joining material until after the joint has been tested and approved.

1. Caulked joints for drain piping shall be used only for piping in a vertical position.

2. Caulked joints for vent piping may be used for piping in a vertical or horizontal position.

(11) **LEAD PIPE.** Joints between lead pipe or fittings shall be installed in accordance with pars. (a) and (b).

(a) *Burned joints.* Burned joints shall be uniformly fused together into one continuous piece. The thickness of the joint shall be at least as thick as the lead being joined. The filler metal shall be of the same material as the pipe.

(b) *Wiped joints.* A wiped joint shall be full wiped, having an exposed surface on each side of the joint not less than $\frac{3}{4}$ inch and shall be at least $\frac{3}{8}$ inch thick at the thickest point.

(12) **PE PLASTIC PIPE AND TUBING.** Joints between polyethylene plastic pipe, tubing or fittings shall be in accordance with pars. (a) to (c).

(a) *Flared joints.* Flared joints shall be made by use of a tool designed for that operation. Flared joints shall be made in accordance with ASTM D3140.

(b) *Heat fusion joints.* Heat fusion joints shall be made in accordance with ASTM D2657. Heat fusion joints shall be of a socket fusion type.

1. Joint surfaces to be fused shall be clean and free of moisture.

2. All joint surfaces shall be heated to the temperature recommended by the pipe or fitting manufacturer and joined.

3. The joint shall be undisturbed until cool.

(c) *Mechanical joints.* Mechanical joints may be installed in accordance with the manufacturer's instructions. Mechanical push-on joints and mechanical compression type joints which use flexible elastomeric seals shall be suitable for potable water.

(13) **PEX PLASTIC TUBING.** Joints between crosslinked polyethylene plastic pipe, tubing or fittings shall be made in accordance with the manufacturer's instructions.

(14) **PVC PLASTIC PIPE.** Joints between polyvinyl chloride plastic pipe or fittings shall be in accordance with pars. (a) to (c).

(a) *Mechanical joints.* Mechanical joints shall be installed in accordance with the manufacturer's instructions.

1. 'Drain and vent systems.' Mechanical push-on joints for drain and vent systems shall conform to ASTM D3212.

2. 'Water supply systems.' Mechanical push-on joints and mechanical compression type joints for water supply systems which use flexible elastomeric seals shall be suitable for potable water.

(b) *Solvent cemented joints.* Solvent cemented joints shall be made in accordance with ASTM D2855.

1. Joint surfaces shall be clean and free of moisture. A primer conforming to ASTM F656 shall be applied to all joint surfaces.

2. Solvent cement conforming to ASTM D2564 shall be applied to all joint surfaces and the joint shall be made while the cement is wet.

3. Solvent cement shall be handled in accordance with ASTM F402.

4. Primer and solvent cement used on pipes and fittings of a water supply system shall conform to NSF 14 and shall be certi-

fied by a nationally recognized testing agency as to conforming to NSF 14. The containers for the primer and the solvent cement shall bear the certification mark of the testing agency.

(c) *Threaded joints.* Threaded joints shall only be used on pipes of schedule 80 or heavier. Threaded joints shall conform to ASME B1.20.1. The pipe shall be threaded with dies specifically designed for plastic pipe. Thread lubricant or tape approved for such use shall be applied to the male threads only.

(15) **STAINLESS STEEL.** Joints between stainless steel pipe or fittings shall be installed in accordance with the provisions of pars. (a) to (c).

(a) *Mechanical joints.* Mechanical joints shall be installed in accordance with the manufacturer's instructions. Mechanical push-on type joints which use flexible elastomeric seals shall be suitable for potable water.

(b) *Threaded joints.* Threaded joints shall conform to ANSI B1.20.1. Pipe joint compound or tape shall be used on the male threads only.

(c) *Welded joints.* Joints between stainless steel pipe or fittings may be welded.

(16) **JOINTS BETWEEN PIPE AND FITTINGS OF DIFFERENT MATERIALS.** Connections between pipes of different materials shall be made with mechanical compression type joints, installed in accordance with manufacturer's instructions or as specified in pars. (a) to (e).

(a) *Copper to cast iron.* Connections between copper pipe or tube and cast iron pipe shall be by means of either caulked joints in accordance with sub. (5) (a) or threaded fittings in accordance with sub. (5) (c).

(b) *Copper to galvanized steel.* Connections between copper pipe or tube and galvanized steel pipe shall be by use of an adapter fitting. The copper pipe shall be soldered to the adapter in accordance with sub. (8) (d). The galvanized steel shall be threaded to the adapter in accordance with sub. (10) (a).

(c) *Cast iron to steel or brass pipe.* Connections between cast iron pipe and galvanized or black steel or brass pipe shall be by means of:

1. Caulked joints in accordance with sub. (5) (a); or
2. Threaded joints in accordance with sub. (5) (c).

(d) *Plastic to other materials.* 1. Connections between plastic pipe and cast iron pipe shall be by means of:

- a. Caulked joints in accordance with sub. (5) (a); or
- b. Threaded joints in accordance with sub. (5) (c).

2. Except as provided in par. (f), connections between different types of plastic pipe or between plastic pipe and other piping materials other than cast iron shall be by means of threaded joints in accordance with sub. (14) (c).

(e) *Lead to other piping materials.* Connections between lead pipe and other piping materials shall be by use of an adapter fitting conforming to s. Comm 84.30 (5) (a). The lead pipe shall be caulked or burned to the adapter fitting in accordance with sub. (11).

(f) *ABS plastic to PVC plastic.* For solvent-cemented connections between ABS and PVC piping in non-pressurized systems, all of the following shall apply:

1. Joint surfaces shall be clean and free of moisture.
2. Primer conforming to ASTM F656 shall be applied to all PVC joint surfaces.
3. Solvent conforming to ASTM D3138 shall be applied to all joint surfaces and the joint shall be made while the cement is wet.
4. Solvent shall be handled in accordance with ASTM F402.

(17) **CONNECTION OF FIXTURES.** Flanged fixtures which have integral traps shall be mechanically fastened to the drain piping by means of a compatible fitting. The joint between the fixture and

the fitting shall be sealed with a watertight gasket or setting compound.

(18) **CONNECTION OF PIPE TO CONCRETE STRUCTURES.** Joints between concrete structures and piping shall be made with mechanical joints in conformance with ASTM C923, ASTM C564 or as otherwise permitted by local authority. Openings for pipe connections that are installed with mechanical joints conforming to ASTM C564 shall have an inside diameter of that required for cast iron pipe in conformance with ASTM A74.

History: Cr. Register, May, 1988, No. 389, eff. 6-1-88; am. (5) (b) 1. b., Register, September, 1992, No. 441, eff. 10-1-92; am. (f) (a) and cr. (13m), Register, February, 1994, No. 458, eff. 3-1-94; am. (2) (c), (3) (a), (4) (a), (c) and (d), (8) (a), (d), (9) (b), (10) (a) and (14) (c), renum. (7) to be (7) (a), cr. (7) (b); Register, December, 2000, No. 540, eff. 1-1-01; CR 02-002: am. (1) (c) 1. to 4., (6) (b) (intro.) and 1., (8) (d), (17) (d) 2., r. (6) (b) 4.; renum. (6) (b) 5. to be (6) (b) 4., cr. (17) (f) and (19), Register April 2003 No. 568, eff. 5-1-03; CR 08-055; am. (2) (a) 2., (4) (b), (6) (a), (8) (c), (9) (a), (10) (b), (14) (a) 2. and (15) (a), r. (12) and (16), renum. (13), (13m) and (17) to (19) to be (12), (13) and (16) to (18) and am. (12) (c) Register February 2009 No. 638, eff. 3-1-09; correction to renumbering of (13) to (18) made under s. 13.92 (4) (b) 1., Stats., Register February 2009 No. 638.

Comm 84.50 Alternate approvals and experimental approvals. (1) **GENERAL.** The provisions of chs. Comm 82 to 84 are not intended to prevent the use of a plumbing material or product not specifically addressed therein if the plumbing material or product has been approved by the department.

(2) **ALTERNATE APPROVAL.** (a) Plumbing materials or products determined by the department to comply with the intent of chs. Comm 82 to 84 and ch. 145, Stats., and not approved under s. Comm 84.10, shall be issued an alternate approval. Alternate approvals shall be issued by the department in writing.

(b) The department may require the submission of any information deemed necessary for review. Sufficient evidence shall be submitted to the department to substantiate:

1. Assertions of function and performance; and
2. Compliance with the intent of chs. Comm 82 to 84 and ch. 145, Stats.

(c) The department shall review and make a determination on an application for alternate approval within 3 months of receipt of all information and fees required to complete the review.

(d) The department may impose specific conditions in issuing an alternate approval, including an expiration date for the alternate approval. Violations of the conditions under which an alternate approval is issued shall constitute a violation of this chapter.

(e) If, upon review, the department determines that a plumbing material or product does not comply with the intent of chs. Comm 82 to 84 and ch. 145, Stats., the request for alternate approval shall be denied in writing.

(3) **EXPERIMENTAL APPROVAL.** (a) The department may allow the installation of a plumbing material or product for the purpose of proving compliance with the intent of chs. Comm 82 to 84 and ch. 145, Stats.

(b) An experimental approval shall be required for each plumbing material or product to be installed for the purpose of proving compliance with the intent of chs. Comm 82 to 84 and ch. 145, Stats. A separate experimental approval shall be obtained for each project where such a product is to be used. Experimental approvals shall be issued by the department in writing. Experimental approvals shall be denied by the department in writing.

(c) The department may require the submission of any information deemed necessary for review.

(d) The department may limit the number of applications it will accept for experimental approval of products.

(e) The department shall review and make a determination on an application for experimental approval within 6 months of receipt of all information and fees required to complete the review.

(f) The department may impose specific conditions in issuing an experimental approval. Violations of the conditions under which an experimental approval is issued shall constitute a violation of this chapter.

(g) If the department issues an experimental approval:

1. Plans detailing the installation of the plumbing material or product shall be submitted to the department in accordance with s. Comm 82.20 (4) or 83.22.

2. A copy of the experimental approval shall be attached to the submitted plans and approved plans.

3. A letter of consent from the owner of the installation shall be attached to the submitted plans and approved plans. The letter shall acknowledge that the owner has received and read a copy of the experimental approval and s. Comm 84.50.

4. The completed installation shall be inspected for compliance with the approved plans by the department. A report on the completed installation shall be written by the department.

5. A written report, from the party who was issued the experimental approval, shall be submitted to the department detailing the function and performance of the installed plumbing material or product. The report shall be completed at time intervals specified by the department, but not less than once a year.

6. On-site inspections shall be performed by the department at time intervals specified by the department, but not less than once a year. A report on the inspection shall be written by the department. The department may assess a fee for the inspection.

7. Five years after the date of the completed installation the department shall within 6 months order the removal of the plumbing material or product, issue an approval, or renew the experimental approval for another 5-year period to obtain additional information to determine the result of the experiment.

(h) If chs. Comm 82 to 84 or ch. 145, Stats., are revised to include or permit an experimental plumbing material or product to conform with the intent of chs. Comm 82 to 84 and ch. 145, Stats., the department shall waive the requirements of par. (f) as to that material or product.

(4) MODIFICATIONS. If a plumbing material or product with an alternate or experimental approval or the installation of an experimentally approved plumbing material or product is modified or additional assertions of function or performance are made, the alternate or experimental approval shall be considered null and void, unless the product is resubmitted to the department for review and the approval is reaffirmed.

(5) REVOCATION. The department may revoke an alternate or experimental approval issued under this section for any false statements or misrepresentations of facts or data on which the alternate or experimental approval was based or as a result of product failure.

(6) LIMITATIONS. An alternate or experimental approval of a plumbing material or product issued by the department may not be construed as an assumption of any responsibility for defects in design, construction, or performance of any plumbing material or product nor for any damages that may result.

(7) FEES. Fees for the review of a plumbing material or product under this section and any required on-site inspections shall be submitted in accordance with ch. Comm 2.

History: Cr. Register, May, 1988, No. 389, eff. 6-1-88; correction in (7) made under s. 13.93 (2m) (b) 7., Stats., Register, August, 1988, No. 392; correction in (7) made under s. 13.93 (2m) (b) 7., Stats., Register, February, 1994, No. 458; am. (3) (g) 1. and 7., Register, April, 2000, No. 532, eff. 7-1-00.